



PROCEEDINGS

The 3rd International Conference on Sustainable Innovation 2019 (ICoSI)



Focal Conferences

- ✓ ISHERSs (International Symposium on Social Sciences, Humanities, Education, and Religious Studies)
- ✓ ISETH (International Symposium on Engineering, Technology, and Health Sciences)
- ✓ ICoSA (International Conference on Sustainable Agriculture)
- ✓ ICoELTICs (International Conference on English Language Teaching, Literature & Linguistics)
- ✓ ICIEFI (International Conference on Islamic Economics and Financial Inclusion)
- ✓ ISCEIE (International Symposium on Civil, Environmental, and Infrastructure Engineering)
- ✓ ICONURS (International Conference on Nursing)
- ✓ ASIAN COL (Asian Conference on Comparative Laws)
- ✓ ICISDE (International Conference on Islamic Studies in the Digital Era)



Universitas Muhammadiyah Yogyakarta
Jl. Brawijaya, Kasihan, Bantul, Yogyakarta 55183, Indonesia



July 30 - 31 2019

Proceedings
The Third International Conference on Sustainable Innovation

ISBN No. 978-623-7054-15-3

Foreword ICoSI 2019

Assalamu'alaikum wr.wb.,

The Third International Conference on Sustainable Innovation 2019 has developed this proceeding. This event was held by Universitas Muhammadiyah Yogyakarta. It's a continuous work from the second one in 2014 which already published in Springer (<https://link.springer.com/book/10.1007%2F978-981-287-661-4?page=1#toc>). Unfortunately, the existence of the first conference cannot be traced down to provide the evidence of its continuity.

This book of proceeding is a remarkable work of scientific effort, trying to serve as a scientific showcase of vast range of field from technology and engineering, health sciences and nursing to social sciences, law, humanity, education and religious sciences. Basically, comprising all schools that exist in this university. At this point, it is a prove of a significant improvement from the previous conference in 2014. While, the previous event only covered three field of agriculture, economics and technology, current conference composed of 9 fields incorporating 9 focal conferences. Those are International Symposium of Engineering, Technology and Health Science (ISETHS), International Symposium of Social Science, Humanity, Education, and Religion Studies (ISHERS), International Symposium of Civil, Environmental, and Infrastructure Engineering (ISCEIE), International Conference of Islamic Economic and Finance Inclusion (ICIEFI), International Conference of Nursing Science (ICoNurs), Asian Conference on Comparative Laws (ASIAN COL), International Conference on English Language Teaching, Literature & Linguistics (ICoELTics), International Conference on Sustainable Agriculture (ICoSA) and International Conference on Islamic Studies in Digital Era (ICISDE).

The abundance of focal conference led to the massive participation and, of course, the richness of works presented, which to the other end meant the difficulty in the organization of the whole event. The complexity of the work can also be found in the selection process of the articles. Indeed, this proceeding has served as the basic platform for the selected participants to present their works apart from others indexed platform. Nevertheless, as can be seen from the articles, the quality of the works is still unquestionable. With the theme of "Sustainable Innovation in Disruptive Era", this conference established two key points of "sustainability" and "innovation" which served as an umbrella theme for the 9 focal conferences. It is also a prove of a sustainability process following theme of "Technology and innovation challengers in natural resources and built environment management for humanity and sustainability" from the previous ICoSI 2014. The relevancy of those words has taken into a more prominent place, nowadays, with the emergence of current issue of sustainability in industry 4.0, where innovation is playing as a prominent factor. Therefore, this conference has successfully lift itself up to act as a showcase for academicians, policy maker and students alike to give broaden perspectives of how to keep innovative in this disruptive era.

We are looking forward to seeing the next ICoSI 2020.

Wassalamu'alaikum wr.wb.

Preface ICoSI 2019

Assalamu'alaikum wr.wb.,

Welcome to the Proceeding of ICoSI 2019.

This book is a showcase of articles presented at the ICoSI 2019, composed of a various range of field incorporating the 9 focal conference. The production of the proceeding was based on the 9 focals, those are: International Symposium of Engineering, Technology and Health Science (ISETHS), International Symposium of Social Science, Humanity, Education, and Religion Studies (ISHERS), International Symposium of Civil, Environmental, and Infrastructure Engineering (ISCEIE), International Conference of Islamic Economic and Finance Inclusion (ICIEFI), International Conference of Nursing Science (ICoNurs), Asian Conference on Comparative Laws (ASIAN COL), International Conference on English Language Teaching, Literature & Linguistics (ICoELTics), International Conference on Sustainable Agriculture (ICoSA) and International Conference on Islamic Studies in Digital Era (ICISDE).

The ISETHS consists of two main field of technology and engineering, and health sciences with several topics: Mechanical engineering, Electrical engineering, Informational engineering, Industrial engineering, Environmental engineering, Medicine, Dentistry, Pharmacy, Biomedical, Public Health, and Health administration. Biomedical, Public health and Health administration.

The ISHERSs incorporates articles from various field those are communication, government studies, education, religious studies, and international affairs. Under the field of communication several topics are developed: journalism, marketing communication, broadcasting, advertising, public relations and communication and new media. The field of government studies comprises of democratic government, public policy and gender and equality. The field of education discuss about educational leadership, technology in education, teaching and learning, assessment, curriculum, cultural issues in education, instructional design and character education. The field of religious studies explores several topics range from Religious and Spiritual Discourses in the Digital World, New Religious Media and Shift of Religious Authority, Digital Religious Learning and the Formation of Self-Piety, The Role of Social Media in Religious Radicalism and its Eradication, Transformations of Religious Rites, Rituals, and Festivals in the Digital Era, Teaching Religious Studies in A New Digital World, Religious Communities and their Role in the Digital Economy, Interfaith Conversations and Debates in the Virtual World., The Future of Digital Religion: Strengthening or Destroying Conventional Religion?. Digitalization of Religious Texts and Interpretive Practices in Contemporary Society. The international relations dig deeper into the topics of Area Studies, Diplomacy and Foreign Policy, Security, Conflict and Resolution, Global and Transnational Issues, Gender and International Relations, New Thinking of International Relations Theory.

The focal of ICoSA discusses several topics include of food security, sustainable agriculture, natural resource productivity, Advances in biotechnology, information and engineering technology, management of agricultural practices.

The ICoNURS covers a various range of topics such as nursing education, bio-psycho-social-spiritual in nursing practice, palliative care, spiritual care, and other specialistic topics in nursing such as community, mental health, and surgical nursing.

For ICIEFI, this event served as the fourth international conference. Current event provided 4 sub theme under the main theme of “Balancing Innovation and Sustainability in Disruptive Era”, those are: Islamic

Economics & Halal Industry, Economics, Banking and Finance Innovation; Assessing Environment Vulnerability, Energy Innovation, Ecotourism and Disaster Management; Islamic Philanthropy (Zakah & Waqf) and Innovation in Education, Health and Social System; and, Small Medium Enterprise, Fintech & International Trade in Industrial Revolution 4.0. All sub-themes were directed toward the spirit of sustainable economic development in disruptive era.

The ISCEIE focused on various field in civil engineering. It covered the field of: Structural Engineering; Construction Materials; Construction and Asset Management; Geotechnical Engineering; Transportation Systems and Engineering; Water Resources Engineering; Environment Engineering; Disaster Mitigation and Prevention.

The ICoELTICs covered a vast field of: Teacher Professional Development, Teachers' Identity, Teacher Training Education, Teachers' Competencies in the EIL 4.0, Pre-service Teachers Readiness in facing the EIL 4.0, 21st Century Skills and Training, Digital Literacy, Character Building in EIL 4.0, Best Practices of EIL 4.0 in School Contexts, Changing Policies in EIL 4.0, Curriculum Development, New Approaches, Methods, and Techniques, Current Trends in Assessment and Evaluation in Language Learning, Recent Issues in Literary Studies, Linguistics and Applied Linguistics, New Trends in Translation, Fostering Entrepreneurship and Innovation, Online and Distance Learning, The Implementation of E-learning Management System, Blended Learning: Effective Tools and Approaches, ICT-based Instructional Design in Language Learning, Immersive Learning with Augmented Reality/ Virtual Reality/ Mixed Reality, Revolutionising Higher Education with Artificial Intelligence, Gamification to Revolutionize Learning Experience.

The ASIANCOL explored the main topic of comparative law, within the perspective of location, geography, space or place. It also questioned traditional narratives of comparative law in the context of the increasing complexity of legal orders within, between and beyond states. The continuity of comparative law in contrast to the law of the states; the implication of this circumstances to the plural legal system; how does the different type of laws (dis/re)-located?

The ICISDE comprised of several topics: Quran and Hadith studies in the Digital Era; Islamic Theology, Philosophy, Mysticism, and Psychology in the Digital Era; Islamic Economics and Finance: Opportunities and Challenges of the Digital Era; Islamic law and politics in the Digital Era; Islamic Education: Opportunities and Challenges of the Digital Era; Islamic Digital Humanities; Innovation and Sustainability in Muslem world; Islamic Communication in New Media; Halal markets, brands, and industries; Islamic ethics in a social media communication; The Divergence of Islamic Authority in the Digital Era; Exploring New Ways of How to be Muslim and Pious in the Digital Era.; Islam and Socio-Political Transformation in the Digital Era; Islam, Radicalism, and Social Media; Islamophobia, Muslim advocates, and Social Media.

In the production of this valuable work, let me convey my gratitude. First of all, to Allah swt, the mighty God, who has given the blessing, so this event has accomplished fruitful. To the Rector of Universitas Muhammadiyah Yogyakarta, specially for the Vice Rector for Academic Affairs who has taken the responsibility to assure this event was accomplished successfully. To all the participants who have share their ideas and effort to presenting their works. To all faculty members of UMY; Dean and Vice Dean, who

have supported us in encouraging and supporting their faculty members in presenting their works. To all supporting staff of UMY in assuring the event was running very well. Last but not least, to all committee members of ICoSI, for their great effort and dedication; especially for the vice chairpersons who have given their full support, considering my paucity of experience and knowledge in conducting such a great event. For me they are not only associates but also the best of friends. Friends who have been spent the last year of sweat and tears to assure all preparation has done perfectly, almost. Just an expression, since there is no perfection in this earthy-world, except in Jannah; the day after. Thus, hopefully, Allah would give you all the best of rewards there, in syaa Allah.

Wassalamu'alaikum wr.wb.

Yogyakarta, 10 Desember 2019



Iman Permana
Chairman of ICoSI 2019

List of Editors

Editor in Chief

Prof. Agus Setyo Muntohar (Universitas Muhammadiyah Yogyakarta)

Prof. Dr. Achmad Nurmandi (Universitas Muhammadiyah Yogyakarta)

List of Editors

SOCIAL, ECONOMICS, EDUCATION, AND HUMANITIES			
No	Full name, title	Email Address	Affiliation, address
1	Prof. Alberto Gomes	A.Gomes@latrobe.edu.au	Plenty Road, Bundoora, Melbourne VIC 3086. Australia
2	Dr. Zain Rafique	zainrfq@gmail.com	National University of Modern Languages, H-9 Islamabad ,Pakistan
3	Dr. Ben Wadham	ben.wadham@flinders.edu.au	Flinders University, Education Building (5.08) GPO Box 2100, Adelaide 5001, South Australia, Australia
4	Dr. Bart Barendregt	barendregt@fsw.leidenuniv.nl	Leiden University, PO Box 9500 2300 RA Leiden, The Netherland
5	Dr. Hasrina Mustafa	hasrina@usm.my	Universiti Sains Malaysia, 11800 Pulau Pinang, Malaysia
6	Dr. M. Reevany Bustami	reevany@usm.my	Universiti Sains Malaysia, 11800 Pulau Pinang, Malaysia
7	Martin van Bruinessen	m.vanbruinessen@uu.nl	Utrecht University, Heidelberglaan 8, 3584 CS Utrecht, The Netherland
8	David Holmes	David.Holmes@monash.edu	Monash University, Faculty of Arts PO Box 197 Caulfield East VIC 3145 Australia
9	Prof. Dr. Achmad Nurmandi	nurmandi_achmad@umy.ac.id	Universitas Muhammadiyah Yogyakarta, Jalan Brawijaya, Tamantirto, Kasihan, Bantul, Yogyakarta, Indonesia
10	Hilman Latief, PhD	h_latief@umy.ac.id	Universitas Muhammadiyah Yogyakarta, Jalan Brawijaya, Tamantirto, Kasihan, Bantul, Yogyakarta, Indonesia,
11	Prof. Dr. Bambang Cipto	bcipto2000@gmail.com	Universitas Muhammadiyah Yogyakarta, Jalan Brawijaya, Tamantirto, Kasihan, Bantul, Yogyakarta, Indonesia
12	Rizal Yaya, SE., M.Sc., Ph.D., Ak, CA.	r.yaya@umy.ac.id	Universitas Muhammadiyah Yogyakarta, Jalan Brawijaya, Tamantirto, Kasihan, Bantul, Yogyakarta, Indonesia
13	Dr. Andreas Ufen	andreas.ufen@giga-hamburg.de	GIGA Institute of Asian Studies Rothenbaumchaussee 32, 20148 Hamburg, Germany

14	Dr PB Anand	p.b.anand@bradford.ac.uk	University of Bradford, Bradford West Yorkshire, BD7 1DP, UK
16	Sang Won Yoon	k.yoon@sheffield.ac.uk	The University of Sheffield Western Bank, Sheffield, S10 2TN, UK
17	Sataporn Roengtam	sataro@kku.ac.th	Khon Kaen University, 123 Mitraphap Road, Nai Mueang, Mueang Khon Kaen, Khon Kaen 40002 Thailand
18	Dr. Yeni Rosilawati, SIP, MM	yenirosilawati@umy.ac.id	Universitas Muhammadiyah Yogyakarta. Jalan Brawijaya, Bantul, Indonesia
19	Dr. Dyah Mutiarin	dyahmutiarin@umy.ac.id	Universitas Muhammadiyah Yogyakarta. Jalan Brawijaya, Bantul, Indonesia
HEALTH SCIENCE AND NURSING			
No	Full name, title	Email Address	Affiliation, address
1	Dra. Maria Dolores Bernabeu Tamayo	MariaDolors.Bernabeu@ua b.cat	Universitat Autònoma de Barcelona, Campus de Bellaterra 08193 Bellaterra (Cerdanyola del Vallès), Barcelona, Spain
2	Asst. Prof. Dr. Sanguan Thanee	sanguan.t@ubu.ac.th	Ubon Ratchathani University, 85 Sathonlamark Road, Warin Chamrap, Ubon Ratchathani 34190, Thailand
3	Asst. Prof. Amornrat Natason	amornrat.n@ubu.ac.th	Ubon Ratchathani University, 85 Sathonlamark Road, Warin Chamrap, Ubon Ratchathani 34190, Thailand
4	Associate Prof. V Dr. Mae-Lanie O. Poblete	mae- lanie.poblete@g.msuiit.edu. ph	Mindanao State University Iligan Institute of Technology Andres Bonifacio Avenue, Tibanga, 9200 Iligan City, the Philippines
5	Assistant Professor IV Neil Madulara Martin	neil.martin@g.msuiit.edu.ph	Mindanao State University Iligan Institute of Technology Andres Bonifacio Avenue, Tibanga, 9200 Iligan City, the Philippines
6	Prof. Kazuko Naruse	k-naruse@slcn.ac.jp	Tokyo Medical University, 6-1-1 Shinjuku, Shinjuku-ku, Tokyo 160-8402, Japan
7	Mohd. Said Bin Nurumal, PhD	mohdsaid@iiium.edu.my	International Islamic University Malaysia, Level 2, Jalan Hospital Campus, 25710 Kuantan, Pahang, Malaysia
8	Shanti Wardaningsih, M.Kep., Ns., Sp. Kep. J., Ph.D	shanti.wardaningsih@umy.a c.id	Universitas Muhammadiyah Yogyakarta. Jalan Brawijaya, Bantul, Indonesia
9	Juan. Manual Leyva Moral., Ph.D, MScN, RN	juanmanuel.leyva@uab.cat	Universitat Autònoma de Barcelona, Campus de Bellaterra 08193 Bellaterra (Cerdanyola del Vallès), Barcelona, Spain

10	Erna Rochmawati Ph.D	erna_rho@yahoo.com	Universitas Muhammadiyah Yogyakarta. Jalan Brawijaya, Bantul, Indonesia
11	Dr. Azlina	nazara@iium.edu.my	International Islamic University Malaysia. P.O. Box 10, 50728 Kuala Lumpur, Malaysia
12	Asc. Prof. Chiang, Hung-Yuan	jiang@ctust.edu.tw	Central Taiwan University of Science and Technology, No. 666, Buzi Road, Beitun District, Taichung City, Taiwan 40601
13	Dr. Elsy Maria Rosa	elsyemariarosa@yahoo.com	Universitas Muhammadiyah Yogyakarta. Jalan Brawijaya, Bantul, Indonesia
14	Nurvita Risdiana, M. Sc	nurvita.risdiana@umy.ac.id	Universitas Muhammadiyah Yogyakarta. Jalan Brawijaya, Bantul, Indonesia
15	Noriko Kuwano, Ph. D	kuwano@oita-nhs.ac.j	2944-9 Megusuno, Oita City, Oita Prefecture 870-1201 Japan
16	Dr. Lee Siew Pien	siewpien@iium.edu.my	International Islamic University Malaysia, P.O. Box 10, 50728 Kuala Lumpur, Malaysia
17	Fitri Arofiati, Ph.D	fitri.arofiat@umy.ac.id	Universitas Muhammadiyah Yogyakarta. Jalan Brawijaya, Bantul, Indonesia
18	Dr. Titih Huriah	titih_psikomy@yahoo.com	Universitas Muhammadiyah Yogyakarta. Jalan Brawijaya, Bantul, Indonesia
19	Dr. Afzan Mat Yusof	afzan@iium.edu.my	International Islamic University Malaysia. P.O. Box 10, 50728 Kuala Lumpur, Malaysia
20	dr. Iman Permana, Ph.D	iman.permana@umy.ac.id	Universitas Muhammadiyah Yogyakarta. Jalan Brawijaya, Bantul, Indonesia
TECHNOLOGY, ENGINEERING AND AGRICULTURE			
No	Full name, title	Email Address	Affiliation, address
1	Prof. Daizo Tsutsumi	tsutsumi-daizo@bio.mie- u.ac.jp	Mie University 1577 Kurimamachiya-cho Tsu city, Mie 514-8507 JAPAN
2	Prof. Wang, Chung- Yue	cywang@cc.ncu.edu.tw	Center for Bridge Engineering Research, National Central University. No.300, Chung-da Rd. Chung-Li city, Tao-Yuan 32011, Taiwan, Republic of China
3	Prof. Masaharu Fujita	fujita@sabom.dpri.kyoto- u.ac.jp	Disaster Prevention Research Institute, Kyoto University, Yoshida-honmachi, Sakyo-ku, Kyoto 606-8501 Japan.
4	Prof. Agus Setyo Muntohar	muntohar@umy.ac.id	Departement of Civil Engineering Universitas Muhammadiyah

			Yogyakarta, Jl Brawijaya, Yogyakarta, Indonesia
5	Associate Prof. An-Jui Li	laj871@mail.ntust.edu.tw	National Taiwan University of Science and Technology. No.43, Keelung Rd., Sec.4, Da'an Dist., Taipei 10607, Taiwan
6	Dina Wahyu Trisnawati, S.P., M.Agr., Ph.D.	dee_wtrisnawati@yahoo.com	Departement of Agriculture Universitas Muhammadiyah Yogyakarta, Jl Brawijaya, Yogyakarta, Indonesia
7	Prof. Hidenori Hamada	h-hamada@doc.kyushu-u.ac.jp	Kyushu University, 744 Motooka Nishiku, Fukuoka 819-0395, Japan
8	Prof. Taiki Saito	tsaito@ace.tut.ac.jp	Toyohashi University of Technology, Hibarigaoka-1-1 Tenpakucho, Toyohashi, Aichi Prefecture 441-8580, Japan, Japan
9	Prof. Chou, Jui-Sheng	jschou@mail.ntust.edu.tw	National Taiwan University of Science and Technology. No.43, Keelung Rd., Sec.4, Da'an Dist., Taipei 10607, Taiwan
10	Ty Tran Van, Ph.D.	tvty@ctu.edu.vn	Can Tho University, Ba Thang Hai, Xuân Khánh, Ninh Kiều, Cần Thơ, Vietnam
11	Prof. Chen, Chun-Tao	chuntaoc@mail.ntust.edu.tw	National Taiwan University of Science and Technology, No.43, Keelung Rd., Sec.4, Da'an Dist., Taipei 10607, Taiwan
12	Prof. Ir. Mochamad Teguh, MSCE., Ph.D.	mteguh07@gmail.com	Universitas Islam Indonesia, Kampus Terpadu UII Jalan Kaliurang km. 14,5 Sleman Yogyakarta 55584, Indonesia
13	Ali Awaluddin, S.T., M.Eng., Ph.D.	ali.awaludin@ugm.ac.id	Universitas Gadjah Mada. Bulaksumur, Caturtunggal, Kec. Depok, Kabupaten Sleman, Daerah Istimewa Yogyakarta 55281, Indonesia
14	Ir. Latif Budi Supama, M.Sc., Ph.D.	suparma@yahoo.com	Universitas Gadjah Mada. Bulaksumur, Caturtunggal, Kec. Depok, Kabupaten Sleman, Daerah Istimewa Yogyakarta 55281, Indonesia
15	Dr. Eng. M. Zuhdy Irawan, S.T., M.T.	irawanzudhy@gmail.com	Universitas Gadjah Mada. Bulaksumur, Caturtunggal, Kec. Depok, Kabupaten Sleman, Daerah Istimewa Yogyakarta 55281, Indonesia
16	Dr. Satoto Endar Nayono	satoto.nayono@uny.ac.id	Universitas Negeri Yogyakarta. Jl. Colombo No.1, Karang Malang, Caturtunggal, Kec. Depok, Kabupaten Sleman, Daerah Istimewa Yogyakarta 55281, Indonesia
17	Dr. Ing. Suwartanti Nayono, S.T., M.Sc.	tantinayono@janabadra.ac.id	Jl. Tentara Rakyat Mataram No.58, Bumijo, Jetis, Kota Yogyakarta, Daerah Istimewa Yogyakarta 55231

18	Dr. Noor Mahmudah, S.T., M.Eng.	noor.mahmudah@umy.ac.id	Universitas Muhammadiyah Yogyakarta, Jl Brawijaya, Yogyakarta, Indonesia
19	Dr. Anas Puri, S.T., M.T.	anaspuri@yahoo.com	Universitas Islam Riau. Jl. Kaharuddin Nasution No 113 Perhentian Marpoyan 28284; Pekanbaru, Riau, Indonesia
20	Prof. Ir. Djoko Legono, Ph.D.	djokolegono@yahoo.com	Universitas Gadjah Mada. Bulaksumur, Caturtunggal, Kec. Depok, Kabupaten Sleman, Daerah Istimewa Yogyakarta 55281, Indonesia
21	Dr. Guntur Nugroho, S.T., M.Eng.	guntur.ars@gmail.com	Universitas Muhammadiyah Yogyakarta, Jl Brawijaya, Yogyakarta, Indonesia
22	Prof Sarwidi, MSCE, PhD.	prof.sarwidi@gmail.com	Universitas Islam Indonesia, Kampus Terpadu UII Jalan Kaliurang km. 14,5 Sleman Yogyakarta 55584, Indonesia
23	Dr. Ir. Muhammad Mukhlisin, M.T.	mmukhlis2@yahoo.com	Politeknik Negeri Semarang, Jl. Prof. H. Soedarto S.H., Tembalang, Semarang, 50275 Indonesia
24	Ir. A.Y Harijanto Setiawan, M.Eng., Ph.D.	harijantosetiawan@yahoo.com	Universitas Atma Jaya Yogyakarta, Jalan Babarsari 44 Yogyakarta 55281, Indonesia
25	Dr. Willis Diana, S.T., M.T.	willisdiana80@yahoo.com	Universitas Muhammadiyah Yogyakarta, Jl Brawijaya, Yogyakarta, Indonesia
26	Dr. Ir. Istiarto, M.Eng.	istiarto@ugm.ac.id	Universitas Gadjah Mada. Bulaksumur, Caturtunggal, Kec. Depok, Kabupaten Sleman, Daerah Istimewa Yogyakarta 55281, Indonesia
27	Dr. Siti Nur Aisyah, SP	snaisyah89@gmail.com	Universitas Muhammadiyah Yogyakarta, Jl Brawijaya, Yogyakarta, Indonesia
28	Dr. Lis Noer Aini, SP, M.Si	neny@umy.ac.id	Universitas Muhammadiyah Yogyakarta, Jl Brawijaya, Yogyakarta, Indonesia

ICoSI Committee

ADVISORY BOARD:

Dr. Ir. Gunawan Budiyo, M.P.

Dr. Sukamta, S.T., M.T.

Prof. Dr. Achmad Nurmandi, M.Sc

Hilman Latief, MA., Ph.D

Dr. Nano Prawoto, SE., M.Si

Prof. Agus Setyo Muntohar, S.T., M.Eng.Sc., Ph.D.(Eng.)

ORGANIZING COMMITTEE

Chairman : dr. Iman Permana, M.Kes., Ph.D

Co-chair : Dr. Yeni Rosilawati, S.IP., S.E., MM
Dimas Bagus Wiranatakusuma, Ph.D

Secretary : Dr. Nuryakin, M.M
Mariska Intan Sari, S.S., M.A.

Treasury : Twediana Budi Hapsari, S.SoS., M.SI.,Ph.D
Dr. Susanawati, S.P., M.P

Scientific Committee

Coordinator : Dr. Sudarisman

Co-coordinator : Eko Priyo Purnomo, S.IP., M.Si., M.Res., Ph.D.

Members : Dr. Iwan Satriawan

Program and Event

Coordinator : Dr. Yeni Rosilawati, S.IP., S.E., MM
Krisna Mulawarman, S.Sos, M.Sn
Erwan Sudiwijaya, S.Sos., MBA

IT Support : Winny Setyonugroho. S.Ked.,MT.,Ph.D
Slamet Riyadi, S.T., M.Sc., Ph.D.

Liaison Officer : Hijriyah Oktaviani, SIP , M.M
Muhammad Muttaqien, M.Sn
Linda Kusumastuti Wardana, S.Pd, M.Sc

Sponsorship

Coordinator : Meika Kurnia Puji RDA., M.Si., Ph.D

Symposia/conferences and Chair Person:

International Symposium of Engineering, Technology and Health Sciences

dr. Imaniar Ranti, M.Kes

International Symposium of Humanity, Education, and Social Sciences

Dr. Suryanto

International symposium of Civil, Environmental and Infrastructure Engineering

Dian Setyawan M, S.T., M.Sc

International Conference of Islamic Economics and Financial Inclusion (ICIEFI)

Zaini Mukhlis, Lc., MRKHS

International Conference of Nursing Science (ICONURS)

Erna Rochmawati, S.Kp., MNSc., M.Med.Ed., P.hD

Asian Conference on Comparative Laws (ASIAN COL)

Yordan Gunawan, S.H., MBA., M.H.

International Conference on Sustainable Agriculture (ICoSA)

Dr. Lis Noer Aini, S.P, M.Si

International Conference on English Language Teaching, Literature and Linguistics (ICoELTics)

Fitria Rahmawati, S.Pd., M.Hum.

Table of Content

<i>Preface</i>	ii
<i>Foreword</i>	iii
<i>ICoSI Committee</i>	vi
<i>List of Editors</i>	ix
<i>Table of Content</i>	xiii
<i>SOCIAL, ECONOMICS, EDUCATION, AND HUMANITIES</i>	1
The Role of Public Relations (PR) in Socially Responsible Business: Analysis of Aqua Danone in Water and Environment Preservation Programs <i>Yeni Rosilawati, Aswad Ishak, Atik Septi Winarsih</i>	2
ICT Development Index and Determinants of Service Trade: Evidence from Top Ten Exporters to Indonesia <i>Nurhanifah, Dyah Titis Kusuma Wardani</i>	7
Benefits of Football Competition in the Economy of Traders in Surajaya Stadion Lamongan <i>Fahmi Anas</i>	12
The Competitiveness of Indonesian Cocoa Product and Their Derivates in the International Market <i>Istis Baroh</i>	17
Comparison of E-Commerce Transactions in Conventional Accounting and Sharia Accounting <i>Eko Sudarmanto</i>	20
The Effect of Audit Quality, Tax Planning and Leverage on Earnings Management <i>Agustine Dwianika, Sila Ninin Wisnantiasri</i>	25
Student's Perceptions of the Role of Politeness in Online Communication <i>Ayu Meiratnasari, Agus Wijayanto, Suparno</i>	33
Edutainment with the Help of Volcanic Media for the Development of Children's Language in Group B at TK X Kamal, Bangkalan <i>Dwi Nurhayati Adhani, Ainin Shofiyah</i>	37
The Power of Myths on Environmental Preservation in Bali <i>Gek Wulan Novi Utami</i>	40
The First Language Interference in Producing English Consonant Sounds <i>Kuntum Palupi Setyaningsih, Agus Wijayanto, Suparno</i>	45
The First Language Interference in Producing English Consonant Sounds <i>Layla Kurniawati</i>	51
A Literature Study: Relationship between the Translation Competency and Translation Quality <i>Meidya Laksmi Ariyanti, Sufriati Tanjung</i>	57
The Approach of English Language Learning: Study Case Grammar <i>I Gede Neil Prajamukti Wardhana</i>	64
Student Self-Disclosure through Instagram Posts to Enhance Classroom Interaction <i>Putu Chris Susanto, I Made Anditawan</i>	67
Social Media and Translation: Analysis for Machine Translation Quality Assessment <i>Risa Mufliharsi, Emzir, Ratna Dewanti</i>	72

Teachers' Professional Learning through the Three-Pronged Approach: Teaching Innovation, Classroom Action Research, and Publication <i>Sri Rachmajanti, Gunadi Harry Sulisty</i>	76
TOEFL Practice Test Using UMY e-Learning and Schoology Mobile Application: A Comparison Study <i>Yashinta Farahsani, Muhammad Budi Nur Rahman</i>	83
Design of E-Tourism System Batang Heaven of Asia as a Tourism Marketing <i>Ari Muhardono, Danang Satrio</i>	87
Cross-Cultural Counseling Module as the Creative Counselor's Attempt for Increasing Student's Empathy <i>Hardi Prasetiawan, Kusno Effendi, Bayu Selo Aji</i>	93
Study of The Existence of Retail Small Traders to Growth Modern Market in Labuhanbatu Regency, North Sumatera <i>Ade Parlaungan Nasution, Pristiyono, Denny Ammary Ramadhan</i>	97
Youtube, from Mass-Self Communication to Commodification of Audience and Worker <i>Puthut Ami Luhur</i>	102
Service Management of Customer Complaints in the Tourism Industry in Yogyakarta (Case Study on Sindu Kusuma Edupark Tourism Yogyakarta) <i>Kristina Andryani</i>	107
Da'wah Materials Centralization as an Effective Guidance in Digital Era <i>Inta Hartaningtyas Rani, Abd. Wahid Wijaya</i>	112
Contradiction of the Disruption Era: Does Disruption Affect Public Policy and Political Interests in Indonesia? <i>Syarifah Adinda Nadyawendi</i>	119
Millennial's ASN: Disruptor of Bureaucracy Towards Humanocracy and Becoming Digitocracy <i>Herie Saksono</i>	126
Mental Health: Strategies to Reduce Pasung Cases in East Java <i>Lutfia Nurul Hidayati, Erna Setijaningrum, Antun Mardiyanta, Susi Hardjati</i>	130
Evaluation of Intangible Assets of Irrigation System in Malang Regency, East Java, Indonesia <i>Nugroho Tri Waskitho, Jabal Tarik Ibrahim, Dyah Erni Widyastuti</i>	134
The Era of Abundance and its Impact on Indonesia Higher Education <i>Gembong Baskoro</i>	139
Motivation of Culinary Tourism Visitors in Santa Market Kebayoran Baru <i>Nurbaeti, R.M.W. Agie Pradhipta, Fifi Nofiyanti</i>	142
The Factors of Destination Image, Destination Satisfaction, and Marketing Communication That Affect Destination Loyalty <i>Retno Widowati, Adhianty Nurjanah, Muhammad Miftahun Nadzir</i>	148
The Resistance of Community in Managing Wisdom Tourism (Case Study: Collaborative Governance Between Villagers and Village Government in Wonokerto Village, Sleman, Yogyakarta) <i>Muchamad Zaenuri, Helen Dian Fridayani, Khusnul Khotimah</i>	153

Fragmented Politics: A Case of Muhammadiyah Elites in the Presidential Elections in Indonesia <i>David Efendi, Husni Amriyanto Putra, Alhafiz Atsari</i>	157
The Involvement of Russian Government In The Syrian Civil War <i>Husni Amriyanto Putra, Mitha Shafraa</i>	169
Roles of Religious Leaders for Behavioral Change in Women and Child Health (Case Study of Roles of Muhammadiyah Aisiyyah Religious Leaders as Agents to Support the Behavioral Change in Maternal Mortality, IVA Screening and Malnutrition in Indonesia) <i>Tri Hastuti Nur R, Hajar Nur S, Mega Ardina</i>	175
Digital Literacy Movement and the Development of Digital Literacy Framework in Indonesia <i>Taufiqur Rahman</i>	183
A Statistical Analysis of the Holy Quran in the Digital Era: Case study of Sura An-Nisa' <i>Akram M Zeki</i>	187
Analysis of Factors Influencing Customers' Satisfaction in Super Indo Supermarket Yogyakarta <i>Dimas Bagus Wiranatakusuma, Hana Putri Ayu Syaraswati</i>	192
Religious Literacy of LDK UNJ Activist <i>R. Siti Nur Lela, Sari Narulita, Devi Kurniati, Aminah</i>	197
Ladies Gym: A Mechanism Disciplining Woman's Body and Violation of Social Media Privacy <i>Anlia Yisca Kristiadi</i>	205
Islamic Masculinity in Indonesian Islamic Movies (The Representation of Men and The Practice of Men's Power in Indonesian Islamic Movies in The Post New Order Period) <i>Muria Endah Sokowati</i>	211
Political Identity of Ganjar Pranowo and Taj Yasin Maimun Candidate Pair in the 2018 Central Java Election Contest <i>Muhammad Nastain</i>	221
Development of Social-Emotional Learning for Generation Alpha in Islamic Education Perspective <i>Anisa Dwi Makrufi, Made Dike Julianitakasih Ilyasa</i>	226
Android-Based Voice Dictionary Application as a Media to Learn Indonesian Languages for Foreign Speakers <i>Tri Wahyono, Fitroh Anugrah Kusuma Yudha, Yashinta Farahsani</i>	232
Self Confidence, Fighting Power, and Achievement Motivation of the IKIP PGRI Pontianak Students in Completing the Study in 2017/2018 Odd Semester <i>Hamid Darmadi</i>	235
The Role of Zakat in Treatment Victims of Natural Disasters -Maqashid Review- <i>Harun Alrasyid, Rafika Nur Laili</i>	245
HEALTH SCIENCE AND NURSING	250

The Identification of Potential Drug-Drug Interactions and the Factors Influencing the Interactions of the Coronary Heart Disease Patients Hospitalizing in Rumah Sakit Jogja during 2014-2017 <i>Pramitha Esha N.D, Reny Rosmasari</i>	251
Determining Nutritional And Health Habits of Bajao People In Relation To Their Health Status: Basis For Health Education <i>Abdullah Junior S. Mangarun, Wraida D. Bacarat, Jomaira U. Hadji Jamil</i>	263
Factors Affecting the Motivation of Nursing Students in Joining the Student Exchange Program <i>Farida Juanita, Arifal Aris, Diaz Innova</i>	265
Factors that Positively Influence to Improve Exclusive Breastfeeding <i>Mina Yumei Santi</i>	268
Effect of Behavior and Environment on Common Cold in Children <i>Arfah Husna, Afriani Maifiz, Enda Silvia Putri, Marniati</i>	274
User Acceptance in Using the Primary Health Care Management Information System: Literature Review <i>Fauzan Kurniawan, Arlina Dewi</i>	278
Improving Healthcare Workers' Compliance On Informed Consent: A Literature Review <i>Roshynta Linggar Andatu, Arlina Dewi</i>	280
Use of Failure Mode Effect Analysis Method to Reduce Medication Error in Hospitalized Patients: Literature Review <i>Nur Laela, Arlina Dewi</i>	283
The Analysis of Determinan Factors Affecting Patient Safety Culture in Hospital <i>Yusuf Susanto, Nur Hidayah</i>	289
The Cost Analysis and the Prediction of Complication Rate among People with Diabetes Mellitus Type 2 <i>Firman Pribadi, Iman Permana, Abdul Ghofir</i>	291
Relationship between Knowledge and Physical Activity in Diabetes Melitus Patient <i>Shinta Wulandari, Akrom</i>	296
The Influence of Evidence Based Practice to Improve Critical Thinking <i>Dina Alfiana Ikhwani</i>	300
Quality of Life in Hemodialysis Patients with Chronic Kidney Disease <i>Virgianti Nur Faridah, Isnii Lailatul Maghfir, Trijati Puspita Lestari, Lora Permata Ariyastuti</i>	307
Exploration of Elder Neglect by Family on The Islamic Perspective in Kalirandu Village <i>Nadya Lestari, Dinasti Pudang Binoriang</i>	309
The Compliance of Hand Hygiene for Professional Nurses Student <i>Suratmi, Sri Hananto Ponco, Nurul Hikmatul Qowi</i>	313
The Effect of Lavender Aromaterapy on Decreasing the Levels of Anxiety in Undergoing Osce for The Second Year Students of Nursing Bachelor of Universitas Muhammadiyah Cirebon 2019 <i>Rully Annisa, Ima Nurhikmah</i>	316
Withdrawal Level of Cigarette Smoker on University Student <i>Resti Yulianti Sutrisno, Wisnu Tri Andono, Aoladul Muqarrobin, Erfin Firmawati</i>	319

Chlorhexidine Gluconate Loading, Release and Degradation in Carbonate Hydroxyapatite Scaffolding for Drug Delivery System <i>Ika Andriani, Edwyn Saleh, Catur Ayuliasitika, Dila Rahmanida</i>	323
Correlation between Internet Addiction Disorder and Prevalence of Withdrawal Symptoms in Late Childhood <i>Prima Hari Nastiti, Yelvi Levani, Sukadiono, Irwanto</i>	327
The Relation between Nurses' Spiritual Intelligence and Patients Spiritual Needs Fulfillment: Cross Sectional Study <i>Syahruramdhani Syahruramdhani, Wawan Sugianto</i>	332
Self-Readiness of Women Who Were Married at Young Ages in Carrying Out A New Role After Being Married <i>Nur Azizah Indriastuti, Rahmi Fahmawinda</i>	335
TECHNOLOGY AND ENGINEERING	341
Strengthening of Reinforced Concrete Slabs using Cold Formed Steel <i>Alamsyah, Indriyani Pululuhawa</i>	342
Analysis of The Type of Dominant Damage at The Drainage Pump (Case Study: Surabaya City Pump Station) <i>Andi Candra Septaprasetya, Umboro Lasminto, Vita Ratnasari</i>	346
Analysis of Caisson Bearing Capacity and Settlement of Abutment in Lemah Abang Bridge <i>Annisa Ramadhani, Miftahul Fauziah, Muhammad Rifqi Abdurrozak</i>	353
Priority Factors for The Sustainability of Local Road Under Community-Based Management in Slum Areas at Pasuruan City <i>Ayu Rahmaniayah, Hitapriya Suprayitno, Eko Budi Santoso</i>	358
Feasibility Planning of Tuban Outer Ring Road Construction <i>Cahya Buana, Alifia Az-Zahra, Catur Arif Prastyanto, Budi Rahardjo</i>	366
Transparency and Accountability Public Sector Procurement for Infrastructure in Indonesia: A Literature Review <i>Dewi Yustiarini, Biemo W. Soermardi, Krishna S. Pribadi, Iris Mahani, Muhammad Farhan Setyawan</i>	371
Technical and Non-Technical Indicators for Service Index Modeling of Polder System with Retention Pond <i>Dina Noviadriana, Ussy Andawayanti, Dian Sisinggih</i>	380
The Effectiveness of Addition of Infilled Wall Against Earthquake Load in Building Models <i>Fanny Monika, Muhammad Ibnu Syamsi</i>	387
The Influence of Soil Parameter to the Retarding Factor of Watershed <i>Gatut Bayuadji, Rispiningtati, Lily Montarcih Limantara, Pitojo Tri Juwono</i>	393
Water Quality and Function Feasibility of Babon River in Semarang, Central Java, Indonesia <i>R. Sarah Wahyudi, S. Imam Wahyudi, P. Hary Subagya, N. Andy Hermawan</i>	396
Good Project Design Indicators for Educational Building in Surabaya <i>Laveda Nidya Irianti, Mohammad Arif Rohman, Farida Rachmawati</i>	400
The Effect of Green Design on Project Success : A Framework <i>Mira Anjar Gita, Mohammad Arif Rohman, Yusroniya Eka Putri</i>	406

Future Transport System with Technology and its Chance for Indonesia : A Review <i>Muchammad Zaenal Muttaqin, Ahmad Munawar, Danang Parikesit</i>	410
Queues and Delays at Unsignalized Intersection, Indonesian Experience <i>Ratnasari Ramlan, Ahmad Munawar, Muhammad Zudhy Irawan</i>	417
Mapping of Congesting Cost for Road Network Performance in Urban Area (Case Study of Urban Intersection on Yogyakarta) <i>Muchlisin, Devi Ariantika</i>	423
Analysis of Geunang Uyat Reservoir Capacity as An Attempt to Overcome Drought During the Dry Season <i>Muhammad Ikhsan, Muhammad Arrie Rafshanjani Amin, Sudirman</i>	429
BIM Based Risk Integration Model in Temporary Structure <i>Ni Putu Ika Frisilia, Tri Joko Wahyu Adi</i>	436
Shear Strength Parameter of MSW Embankment Due To Decomposition Process <i>Putera Muhammad Akmal, Rifa'i Ahmad, Faris Fikri</i>	439
The Strength Characteristics of the Square and Circular Short and Long Column <i>Rahmani Kadarningsih, Rifadli Bahsuan, Saiful Sultan Tanamas</i>	444
GFRP as an Alternative to Steel for Sustainable Reinforced Concrete <i>Rezky Aprilyanto Wibowo</i>	451
Method For The Selection Of Water Supply System (WSS) Project (Case Study: East Java Province WSS) <i>Riska Dewi Wijayanti, Hitapriya Suprayitno, Endah Angreni</i>	456
Strategic Analysis of Workshop and Dormitory Building Utilization to Support Construction Training in Construction Service Office Unit IV Surabaya <i>Rizky Kurniasih, I Putu Artama Wiguna, Ria Asih Aryani Soemitro</i>	463
Redesign Intersection with Roundabout and Pedestrian Service Analysis at 0 Km Yogyakarta <i>Rizky Gusti Ranardi Putra, Prima Juanita Romadhona</i>	472
Analysing Risk for Sustainable Construction Project Using Fuzzy logic: A Concept <i>Sony Susanto, I Putu Artama Wiguna, M. Arif Rohman</i>	478
Comparative Methods Analysis to Determine Open Channel Dimensions in Pit Mine <i>Tedy Agung Cahyadi, Sudaryanto, Suyono, Eddy Winarno, Angelina Metta Arilia, Charles Andrianto</i>	484
Community Participation Criteria to Achieve Sustainable Road Projects <i>Wahyu Adistyia Rindarti, Mohammad Arif Rohman, Cahyono Bintang Nurcahyo</i>	490
The Potential of Peanut as Primary Material for Peanut Butter Agroindustry in Indonesia <i>Nurfa Anisa, Pratikto, Purnomo Budi Santoso, Ishardita Pambudi Tama</i>	496
Designing Control Systems for Jig Rotary Table on The Spot Welding Machine by using the PLC <i>Syahril Ardi, Muhammad Hidayat, Ardi Winata, Suhartinah</i>	508
Quantity and Quality Test of DNA Soybean Mutant Lines (Glycine max L. Merrill) <i>Anggria Lestami, Diana Sofia Hanafiah, Revandy I. M. Damanik</i>	513
Performance of Three Varieties on True Shallot Seed (TSS) Seedling in Sand Soil Area <i>Joko Pramono, Sutardi, Bambang Sutaryo</i>	518

Evaluation of Several Rice Varieties (<i>Oryza sativa</i> L.) in the Minapadi Cultivation System in Sleman, Yogyakarta <i>Kristamtini, Endang Wisnu Wiranti, Sugeng Widodo, Joko Pramono</i>	524
Growth and Production of Shallots (<i>Allium ascolanicum</i> L.) by Application of Vermicompost and Liquid Organic Fertilizer of Lamtoro Leaves <i>Wan Arfiani Barus, Hadriman Khair, Muhammad Wira Ifandi</i>	528
Utilization of RAPD Markers to Analysis Genetic Diversity Oil Palm (<i>Elaeis guineensis</i> Jacq.) <i>Sri Mekar Melati, Lollie Agustina P. Putri, Eva Sartini Bayu, Asni, Khoirunnisa Lubis</i>	532
Morphological Response Of Some Brown Rice Varieties (<i>Oryza sativa</i> L.) Using PEG 6000 at Vegetative Phase <i>Siti Fadhilah, Asni, Eva Sartini Bayu, Hot Setiadi</i>	537
Profile of Oil Palm (<i>Elaeis Guineensis</i> Jacq.) DNA Band DxP 540 NG Variety Based on RAPD (Random Amplified Polimorphism DNA) Marker <i>Rumata Yohana Diantoro, Lollie Agustina P. Putri, Eva Sartini Bayu, Diana Sofia Hanafiah, Asni</i>	542
Cause of Delay and Waste Time Turbine Hall PLTU Semarang <i>Harsoyo, Y.A, Arkan, M.R</i>	548
Analysis of Operation Pattern of the Bajulmati Reservoir <i>Erlin Susanti, Umbaro Lasminto, Theresia Sri Sidharti</i>	554
Test of Concentration and Dosage of Fruit Organic Waste Extract on the Growth and Yield of Broccoli (<i>Brassica oleracea</i>) Plants <i>Dyah Roeswitawati, Abdul Malik, Aniek Iriany</i>	563
Impact of Wild Cicer Species on Production under Climate <i>Amar Ma'ruf, Duygu Sari, Hatice Sari, Tuba Eker, Cengiz Toker</i>	568

SOCIAL, ECONOMICS, EDUCATION, AND HUMANITIES

The Role of Public Relations (PR) in Socially Responsible Business: Analysis of Aqua Danone in Water and Environment Preservation Programs

1st Yeni Rosilawati

Communication Department
Faculty of Social and Politics
Universitas Muhammadiyah Yogyakarta
(UMY)

2nd Aswad Ishak

Communication Department
Faculty of Social and Politics
Universitas Muhammadiyah Yogyakarta
(UMY)

3rd Atik Septi Winarsih

Government Studies
Faculty of Social and Politics
Universitas Muhammadiyah Yogyakarta
(UMY)

Abstract— Corporate Social Responsibility (CSR) encourages the company to look further beyond the usual base to a wider region, which is social at large and communities. This paper aims to identify the role of Public Relations (PR) in CSR of Aqua Danone Klaten in socially responsible business in water and environment programs which were implemented in Polan Harjo Village, the local community that lives around the operating factory of Aqua. This paper used qualitative approach, specifically using case study method. It employed in-depth interviews that were conducted with the local community and working managers who deal with CSR issues and strategy on day-to-day basis. Secondary data was gathered in the form of information about CSR programs from regular reports downloaded from the company's website, mass media news downloaded from the internet and other resources. The research found that PR process is involved in CSR steps from fact-finding until monitoring. The study also found that Aqua Danone Klaten carried out proactive dialogue with stakeholders. The planning until the assessment was conducted through discussions with community leaders, communities, and local governments to give ideas, criticisms, and testimonials towards CSR programs. The research also identified that Public Relations (PR) also adopt stakeholder engagement strategy. In this strategy, business enterprises prioritize dialogue and engagement with stakeholders and develop interactive systems with various stakeholders.

Keywords— CSR; Role of PR; business; stakeholders; engagement.

INTRODUCTION

Corporate Social Responsibility (CSR) is an obligation to take actions that can contribute to the benevolence and interests of the community extends beyond legal and economic obligations to obtain long-term benefits that are beneficial to the communities (Daft, 2012).

According to Luu Trong Tuan (2012), Corporate Social Responsibility (CSR) as an ethical and ethical trade company that is responsible for holders of selari with cases that may be accepted in civil society. Social meaning means responsibility for the economy and environment. The aim is to create a better standard of living, while maintaining the continuity of the growth of the trade company through increasing profits and value for the livelihood of people both inside and outside the company. Frederick (1986) opined that CSR is the principle of ethics of management in the formation of commercial police companies. CSR embraces ethical guidelines which rely on

human awareness, society and development in a handsome manner.

CSR considered as a package that gives maximum impact to the community, by encouraging people to become more empowered. CSR needs two main pillars: business partnerships and community development, to provide welfare to the people of Indonesia. In Indonesia, the obligation for companies to do CSR activities is listed in act number 40 of 2007 article 74 of the Limited Liability Company. CSR activities are carried out to preserve the sustainability of the natural environment directly or through collaboration with other stakeholders. CSR activities are usually performed through environment campaign, education, and training, forestation, the establishment of green open spaces and parks, saving of natural resources that are used in factories or stores, the application of recycling and reuse of products.

CSR evolved from charitable activities to business-oriented activities. It describes the business image itself. Businesses should also look into social issues as well as financial issues. In real business governance, emphasis on economic aspects alone can have a negative impact on the environment and society (Nor Hadi, 2014).

CSR encompasses management as a result of decisions and activities on society and the environment. This concept can be carried out through transparency and ethical behavior that advocates for sustainable development, including health and welfare, taking into account the goals of the stakeholders and complying with the laws and rules set with international norms.

In Indonesia context, according to Prayogo (2013), the concept of Corporate Social Responsibility (CSR) in Indonesia is closely related to the aspects of sociology, namely the relationship that occurs between the company and the local community. When trading companies exploit natural and mineral resources, the local community is positioned as the main holder.

Aqua Danone Background

The CSR of Aqua Danone is deeply rooted in the commitment of the company. The commitment is the way to conduct the business which does not only concern with economic performance but also on social issues. This idea is in accordance with the principles of the founder of Aqua, Tirta

Utomo, who believes that businesses should contribute towards society. This idea is revealed in "Aqua Lestari" which were has been developed since 2006 as a sustainable initiative which was using DANONE WAY and ISO 26000 as a Sustainability Report reference (<https://aqua.co.id/keberlanjutan>).

AQUA Group was awarded the MDG Awards (IMA) for its support of MDG (Millennium Development Goals) in Indonesia. Other programs that were awarded include the School Supporting Program di Keboncandi, Gondang Wetan Area, Pasuruan Region, East Java became a winner in the education category. Program Water Access, Sanitation, and Hygiene (WASH) and the clean water access and Hygiene won the 2nd place for Access for Clean Water Service and School Sanitation Program "Sahabat Mata Air" program in Pasuruan Region, East Java became the nominator of education category (<http://www.aqua.com/beranda>).

Danone group also gained the number one rating in Access to Nutrition Index (ATNI) in 2013. This index measured over 25 companies in the world in terms of their commitment to issues related to poor nutrition and related disease. ATNI aims to support the companies to increase the consumer's awareness towards nutritious food and drinks awareness through product formulation, pricing and distribution and to examine the effect of company to the consumer's preference, and the companies behavior through their marketing, labeling and promoting healthy diets and active lifestyles (<http://www.accessnutrition.org/>).

LITERATURE REVIEW

The Concept of CSR

Corporate Social Responsibility (CSR) is a evelving concept from time to time and is influenced by community development. More definitions have been given by scholars than in various fields. According to Ullman (1985), Corporate Social Responsibility (CSR) is the interests of commercial companies to take on the role of being responsible for society has become the main topic in scientific studies in several decades. There are many definitions of CSR, varying from simple definitions to complex ones and various terms and ideas. Various definitions are definitions that can be exchanged such as corporate sustainability, corporate citizenship, corporate social investment.

Shafiqur Rahman (2011) summarizes Corporate Social Responsibility (CSR) to the ten dimensions namely "protection of the natural surroundings, economic development, practice of trade ethics, fulfillment of legislation, volunteerism, human rights (HAM), transparency and accountability and the involvement of stakeholders".

CSR is derived from business ethics (Nor Hadi, 2014). Ethics is an effort that was born since the collapse of moral values in the Greek culture system. The good and bad views can be no longer trusted, so the philosophers are asked to explain the norms of societies. Ethics is a critical view of the lesson or moral thoughts (Suseno, 1987)

Business is the relationship between people to people. Business is the interaction that occurs due to the lack of needs and wants that we cannot achieve by yourself. Through business, people can fulfill their needs (Panuju, 1995). The standards of business ethics which can easily to see is honesty

and transparency. In business, people entrust all things such as reputation, his or her family, the future of the employee, and the future of the society (Keraf, 1998). Business is an important activity of the society. Business is a modern phenomenon that cannot be avoided by society nowadays.

They are two ways of how a person can make an ethical decision: fist is through prescriptive approaches, to provide tools to make a decision, and the second is through the psychological approach. The psychological approach relates to individual ethical decisions. Individual differences and cognitive process create different thinking and will give an impact on how a person think and act ethically.

Public Relations (PR) and CSR

Many Public Relations (PR) professionals believe there is a strong connection between public relations and CSR, and that public relations play a big role in making this a priority for a business. Benneth Freeman, former US deputy assistant secretary of a state for democracy, human rights, and labor, claims that in this era of scrutiny, corporate reputation and corporate responsible are inseparable.

Bennet and Rentschler (2003) emphasized that the company's reputation is a concept that relates to a public appraisal of company quality, trust, and reliability. Reputation plays an important role in the success of an organization. Esen (2013) emphasizes the reputation of a meaningful competitive advantage and is regarded as a very important asset to the company. Subtle elements such as the investigation and development of intellectual property rights, convenience, workers, consumers and reputation itself build a reputation

Esen (2013) opined that CSR is a way of how a business company supports policy demands from the community uplifting the reputation of a business company. A good reputation will increase the value of the brand and the goodwill of a business company. The company has no reputation alone at a time. Reputation depends on the attention of stakeholders. Brand interactions, related stimuli (including mass communications, employees, agents or others or other brands associated with the brand), allow stakeholders to form their perceptions of business companies.

Morsing and Schultz (2006) emphasized three types of relationships with stakeholders in the activities of companies involved in Corporate Social Responsibility communication developed from the Grunig & Hunt (1984). According to Morsing & Schultz (2006) in the Stakeholder Information Strategy, communication is always one way, i.e. from the company to the stakeholders. Communication is seen as "auctioned, not listening" (telling, not listening). One-way communication has the purpose of delivering orders rather than by persuading them to inform the company in real terms about the company. The company uses a stakeholder information strategy model in the form of press relations, news for the media, as contained in brochures, magazines, facts, figures, and schedules to the public.

In response to stakeholder models, communications are implemented from and to the public. In this strategy, business prioritizes stakeholder responses, but not on their involvement in the communication process. Stakeholders are influenced by companies but are considered passive in responding to business initiatives. The last is the Stakeholder Engagement strategy. In this strategy, business enterprises prioritize

dialogue and engagement with stakeholders and develop interactive systems with various stakeholders. Communication exists in a balanced bilateral dialogue. Communication goals are mutual understanding, consent, and awareness of both parties. With these three models of communication strategies, CSR managers can learn the techniques and communications of CSR to encourage stakeholder engagement.

RESEARCH METHODOLOGY

This paper used a qualitative research approach, specifically the inquiry case study method. In-depth interviews were conducted with the local community and working managers who deal with CSR issues and strategy on a day-to-day basis. Secondary data included information about CSR program based on sustainable reports downloaded from the company's website, mass media news downloaded from the internet and other resources.

FINDINGS & DISCUSSIONS

Aqua Danone is the biggest bottled water in Indonesia, controls around 40 % percent of Indonesia's bottled water market and is owned by France's Danone. Aqua Danone which invests around \$100 million a year in Indonesia, currently has 17 Aqua plants in the country and aspires to launch 10 more within the next few years. Aqua Danone performs CSR through community development in education, health, facilities, and environmental conservation in accordance with the function, objectives, and CSR Dimensions (Profit, People, and Planet). The CSR program is based on sustainable development, which is systematic. Aqua Danone implements CSR in two ways, which not only give benefit to the company but also the local community.

The CSR steps that are carried out by Public Relations (PR):

1. Identification of the problem (Planning Phase)

This process involves community participation which involves different stakeholders. They are the local community, the local government, and the NGOs. The planning phase is carried out by using PRA (Participatory Rural Appraisal) and ZOPP. In the planning phase, the local community tries to identify their own problem. In addition, they also try to find ways to solve the problem. As a company that conducts CSR, Aqua Danone Klaten will classify the suitable program according to their CSR values and visions. CSR complies with the main pillar of CSR Danone, which is water conservation and to strengthen the local economy. According to him, s a multinational corporation (MNC) CSR is undertaken beyond the guidelines of Danone, Danone Way and it is based on the local needs that may vary from one host country to another. In addition, according to him, CSR program conducted by Danone should be appropriate to the local wisdom of the society. As explained by the Sustainability Development manager:

Altogether they are 8 villages that have been chosen as beneficiaries of CSR. The villages are directly affected by the activities of the factory. The CSR Program of Aqua Danone is based on the CSR pillars of Danone, they are water conservation and

strengthening the local economy. The implementation of CSR should be based on local culture as well as local wisdom which belongs to society. Polan Harjo village is a suburban area where most residences are farmers. They have their own local wisdom value such as gotong royong (mutual help) and also "srawung" (people should blend into society), and also tepa selira (tolerance). These local wisdom are common local wisdom which is held strongly by the Javanese people.

According to him, CSR should be in line and in harmony with the local wisdom, such as building a coop. It represents the gotong royong (mutual help) value of the society of Polan Harjo. The local wisdom facilitates social capital to succeed the programs. Social capital is a social resource that belongs to the community. As a resource, social capital giving the strength in some social conditions in the community. Social capital refers to the main aspect of social organization, such as trust, norms, and networks that will enhance the efficiency of society. Almost all of the CSR programs include cleaning the Pusur River which is done regularly by communities and Aqua Danone forestation, the building of the wells and biopori, managing waste and environment, conducted the POSYANDU programs and building of public facilities such as road and other facilities.

According to a local community member in Polan Harjo, he said that the local wisdom such as gotong royong is used to solve the community's problem in Polan Harjo and become the key aspect to support CSR programs. For instance, when the waste bank is founded, the local community give their support by doing mutual help (gotong royong). Some of them were giving bricks and the rest were giving clay tile, so they built the building of waste bank by their own resource. They also use "gotong royong" value to solve some of the community's problems, and also doing discussion and consensus (musyawarah and mufakat) to solve their own community's problem.

2. Implementing the program

Public Relations (PR) involve different stakeholders including the local community, local government, and also NGOs in the CSR Programs. The CSR activities that are conducted by Aqua Danone are as follows:

- a. Aqua Danone Klaten and the community of Polan Harjo carried out a traditional ceremony called "Merti Bumi". This traditional ceremony is based on local wisdom that belongs to the local community. Merti bumi is a tradition of Javanese society to express the gratefulness in the harvest. Merti bumi symbolizes grateful feelings and prayers to God. They also express gratitude for welfare, safety, and peace. Merti Bumi consists of sharedness value, gotong royong (mutual help) value which is important in the Javanese culture.
- b. Organic Farm: Aqua Danone Klaten collaborated with the community that comprises of farmers named "Tani Mulyo" in Polan Harjo Village,

Klaten Region, Central Java Province. The program was intended to cultivate rice fields using organic systems. They used the organic system twice during the growing season and then expand their area. They planned to grow 75% of the area with the eco-friendly rice fields. Aqua Danone also builds a factory of organic fertilizer and a training center as a support facility. "Tani Mulyo" 7 hectares of rice fields have already harvested in the first week of February. This program was aimed to give useful information and awareness to other groups of farmers who are still using chemicals and pesticides. To inculcate the concept of organic farming, Aqua Danone prefers an individual approach to the farmers involved. They were persuaded to join and optimize the group that has been formed. Through their participation in the group, farmers can learn and share information and knowledge with each other

- c. The ministry of Koperasi and SME established the coop "Pusur Lestari". The coop "Pusur Lestari" is the coop founded by the farmers in Klaten, Central Java Province. It aims to help 385 farmers from 36 villages. This coop is another CSR effort of Aqua Danone that is in line with government efforts to grow the economy, improve labor skills and being eco-friendly. "Aqua Danone" also facilitates the coop by giving farmers who live in the area of Pusung River access to market their products. This helps farmers to market their products directly without having a deal with the middleman. Their products are now readily accessible in the modern retail store.
- d. Managing waste through WASH (Water Access Sanitation & Hygiene) campaign. Waste is one of the main problems in many villages. To solve the problem, the local community empowers themselves by building the capacity to manage waste. This began with the comparison study to Yogyakarta, as they tried to classify waste, and then attempt to try to create a product from waste. The intention was to create new products that have an economic value of the waste. Besides, they also built "Waste Bank" or Bank Sampah in KarangLo Village and Polan Village. Beside managing waste, they also make a campaign to keep the river to be clean, and handwash with soap (Cuci Tangan dengan Sabun), and to properly manage water for consumptions.

3. Evaluation and mitigation

The community is involved in measuring and reducing the negative impacts of development and monitoring. Monitoring means ensuring that project activities are implemented according to plan. The monitoring of programs is done regularly with the community members and others involved in a project. This includes working collaboratively in developing the evaluation plan, conducting the evaluation and sharing and using the results

Aqua Danone Klaten employed the CSR through community development in education, health, facilities and environment conservation based on the functions, objectives, and dimensions of CSR (Profit, People, Planet). The CSR program was based on the concept of sustainability development, and through systematic and long- conducted orientation. In addition, they implement the CSR in both two ways, which do not only give benefit to the company but also give benefit to the local community

Through the CSR programs of Aqua Danone Klaten, the local community are motivated to engage in their own society and actively participate as members. This is evidenced through the sharing of ideas, solving problems together and using the values in local pearls of wisdom. The study found that CSR implemented by Aqua Danone Klaten involves stakeholders. In the implementation up to the monitoring process, Aqua Danone Klaten involves local communities, non-governmental organizations (NGOs), local government, foundations, universities and scholars to be involved through various approaches and cooperation.

The study found that Aqua Danone Klaten had a regular and proactive dialogue with stakeholders. The assessment was conducted through discussions conducted by community leaders, communities and local governments to give ideas, criticisms, and testimonials to the CSR programs. According to Morsing & Schulz (2006) on stakeholder engagement strategies. In this strategy, the company prioritizes dialogue and engagement with stakeholders and develops interactive systems with various stakeholders. Communication exists in a balanced bilateral dialogue. Stakeholders are involved, participate and provide recommendations on corporate responses and implement reconstruction of CSR. The involvement of local communities and other stakeholders, such as local government, community and customary figures, various non-governmental organizations, foundations, and educational institutions within CSR effort to develop value through the approach towards stakeholder.

The CSR programs of Aqua Danone Klaten were planned collaboratively with the local community. Participation becomes an important part of achieving goals. The process involved is: 1) identification of the problem. Society together with the planners and the authorities access issues in group discussions, brainstorming, identify opportunities, potentials and constraints; 2) The community are involved in planning process and strategies that are based on the results; 3) the implementation of development projects; 4) evaluation; 5) mitigation people involved in measuring and reduce the negative impacts of development 6) monitoring CSR programs that were conducted by Aqua Danone also strengthened local knowledge. For instance, in the Merti Bumi program, they tried to maintain the local wisdom traditions that belong to society. The other program such as the building the coop "Pusur Lestari", they tried to embody the local wisdom gotong royong (mutual help) and in every CSR programs that were carried out, the local wisdom such as "gotong royong" (mutual help), musyawarah and mufakat (discussion and consensus), "srawung" (blend into the society) functioned as social capital that builds the capacity of community to reach the goals.

CONCLUSIONS

1. Aqua Danone's CSR initiatives are carried out in many programs including the water and forest conservation

- system, and the strengthening of the local economy. These programs involved strategic stakeholders including the local community, local government, and NGOs. The CSR process including facts and findings, implementing and communicating and end up with monitoring the programs.
2. In order to manage relationships with stakeholders appropriately, Public Relations (PR) does not only adopt CSR as an integral part of the company's mission, but it is also effectively communicated to stakeholders. CSR initiatives consider local characteristics and are based on social cultures as well as local wisdom employed by the community. The local characteristics such as local wisdom are a social capital that can be developed and supported through CSR. CSR also synergizes and based on national and local government programs. CSR programs play an important role in the push to create a balance in economic development and social environments. Local communities as key stakeholders and also the main beneficiaries of the CSR program requires companies to be more responsive to social and environment and local conditions.
 3. Public Relations (PR) placed the community as a key player in every stage of the program implementation and involves them in selecting and fix issues to be incorporated into the CSR which includes community development, economic empowerment, social coordination and the environment simultaneously. Public Relations (PR) also adopted a community-based approach by placing the needs and values that are occurring in society as the ultimate goal of organizing CSR programs. Public Relations (PR) was also aware that living and maintaining a sustainable business company is heavily dependent on community support. That's why good relationships between business and community become the capital base of business. The stakeholders are a strategic part of the CSR implementation carried out by Aqua Danone Klaten and establish communication with stakeholders not only in CSR programs but also in other activities such as community relations.

REFERENCES

- [1] Bennet, R., & Rentschler, R. (2003). Foreword by the guest editions. *Corporate Reputations Review*, 6(3), hal 207-211.
- [2] Daft, R.(2012). *Management*. USA: Cengage Learning.
- [3] Esen, E. (2013). The influence of Corporate Social Responsibility (CSR) activities on building corporate reputation. *International Business, Sustainability and Corporate Social Responsibility*, 11, hal. 133-150
- [4] Frederick, W.C. (1986). CSR: Why ethical analysis is indispensable and unavoidable in corporate affairs. *California Mngt Review*
- [5] <http://www.aqua.com/beranda>
- [6] <http://downtoearth.danone.com/about>
- [7] <http://www.accesstonutrition.org/>
- [8] <https://aqua.co.id/keberlanjutan>
- [9] Keraf, Sony. (1998) *Etika Bisnis, Tuntutan & Relevansinya*. Yogyakarta: Penerbit Kanisius
- [10] Morsing, M., & Schultz, M. (2006). Corporate social responsibility communication: stakeholder information, response and involvement strategies. *Business Ethics: A European Review*, 15(4), hal. 323- 338.
- [11] Luu Trong Truan (2012). Corporate Social Responsibility, ethics and corporate governance. *Social Responsibility Journal*, 18(4), hal 547-560.
- [12] Nor Hadi. (2014) *Corporate Social Responsibility*, Yogyakarta: Graha Ilmu
- [13] Panuju, R. (1995) *Etika Bisnis Tinjauan Empiris dan Kiat Mengembangkan Bisnis Sehat*. Jakarta: Gramedia
- [14] Prayogo, D. (2013). Measuring CSR for local communities in mining, oil and gas industries, the case of Indonesia. *Journal of Economics and Sustainable Development*, ISSN 2222-2855, 4(1), hal. 59-69.
- [15] Shafiqur Rahman (2011). Evaluations of definitions: ten dimensions of corporate social responsibility. *World Review of Business Research*, 1, hal 166-176.
- [16] Suseno, F.M. (1987) *Etika Dasar: Masalah-masalah Pokok Filsafat Moral*. Yogyakarta: Kanisius
- [17] Ullman, A.A, 1985: Data in search of a theory: A critical examination of the relationships among social performance, social disclosure & economic performance of US Firms. *Academy of Mng Review*, 10(3), 540-558

ICT Development Index and Determinants of Service Trade: Evidence from Top Ten Exporters to Indonesia

1st Nurhanifah

Department of Development Economics, Faculty of Economics and Business
Universitas Muhammadiyah Yogyakarta
Yogyakarta, Indonesia
nurhaniifah92@gmail.com

2nd Dyah Titis Kusuma Wardani

Department of Development Economics, Faculty of Economics and Business
Universitas Muhammadiyah Yogyakarta
Yogyakarta, Indonesia
dyahtitis.wardani@gmail.com

Abstract— *The world is now entering the era of industrial revolution 4.0, which emphasizes the pattern of digital economy, artificial intelligence, big data and robots or commonly known as the phenomenon of innovation chaos. With the rapid development of electronics, Information and Communication Technology (ICT), better known as ICT-based electronic advances, this has an impact on international and domestic trade. There is progress in ICT, in this case making distance less influential in trade. This is because there is no need for meetings or face-to-face meetings because they have been replaced by electronic mail or cellphones. In this study, we want to examine the impact of ICT on international trade, especially the total service trade between the ten highest service sector exporters to Indonesia. This study uses a panel data with gravity model framework for the period of 2012-2016. The results show that, ICT has a positive and significant impact on export of ten countries services to Indonesia. Other variables such as the GDP of the exporting country have a positive effect on trade service, while export destination countries have negative effect on trade services. In addition, distance, has negative and significant effect on service trade. This is in line with the gravity model theory, whether distance has negative relationship on trade. In this case, distance represents transportation cost. Country characteristic such as openness of exporters has a positive and significant effect on service trade. In contrast, openness of destination country has negative and significant effect on service exports to Indonesia.*

Keywords— *information and communication technology (ICT), service trade; gravity model, disruptive innovation*

I. INTRODUCTION

Currently, the development of digital technology or so-called the Information and Communication Technology (ICT) is growing rapidly that it reaches almost all aspects of human life. Technological advances have brought a rapid change and shift in a life without limits in this Industrial Revolution Era of 4.0. The development of information technology forms a new world society that is no longer hindered by territorial boundaries and has reversed everything that has become so close that the development of ICT has reduced even eliminated the barriers that information cannot be accessed. Therefore, eventually, small entrepreneurs and traders have better access to international markets. Information and Communication Technology has become a new resource for economic growth, as can be seen from the impact of the use of ICT in a broad manner. Allowing the implementation of more efficient ways for consumption, distribution and production of

goods and services (Syafirin, 2010). The use of technology also encourages rapid business growth, because various information can be presented through long-distance relationships and no need for face-to-face meetings when traders want to make a transaction, since it has been replaced by telephone, e-mail and etc. (Detter, 2014). ICT has made a significant contribution to the globalization of the world economy by enabling cross-border ideas, knowledge, expertise and innovation (Choi, 2010). In the 2000s, there have been remarkable changes that have occurred such as increased economic activity and accelerated productivity growth as a result of the ICT revolution. One example of a significant increase in service trade that coincides with the progress of ICTs (Liu and Nath, 2016).

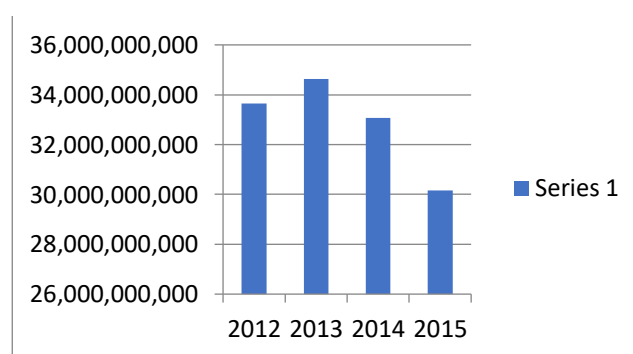

Source: UN-COMTRADE (2019), Author Estimation

Even though technological advances are increasingly rapid, international trade transactions in the service sector sent to Indonesia have decreased. The picture above shows the number of services sent to Indonesia over the past four years. In 2012, the number of services sent to Indonesia reached 33,652 million USD and in 2013 it increased by 34,641 million USD. But in the following years the value declined to reach 30,170 USD. This has become an interesting phenomenon to study about what factors are the causes of the decline in export services. Considering information and communication technology that should increase the value of trade between countries because of the use of ICT which enables the application of efficient methods for consumption, distribution and production of services and goods. In addition, technology

in trade makes it easy to access information so that producers have better access to international markets.

II. LITERATURE REVIEW AND HYPOTHESIS FORMULATION

The research conducted by Liu and Nath's (2016) research results in his research using panel data for 49 countries during the period of 2000-2013, they reveal that IDI has a positive and significant influence on service exports. In addition, Nath (2016) analyzes the impact of IDI on international trade between Turkey and its trading partners. His research is applying gravity models and using panel data for 35 countries exporting during the period 2000-2014, and results show that, GDP, IDI and distance have influence on exports. Moreover, IDI has a positive and significant effect on exports, as well as GDP which has a positive and significant effect on exports. Meanwhile, distance has a negative and significant effect on exports. Next is the research of Li, Song and Zhau (2008) which defines that economic distance is the distance that represents the transportation costs by a country when conducting trade activities. Distance affects trade between countries in the form of decreasing trade, the farther the distance, the greater the transportation costs incurred, the lower the volume of exports, although according to Detter (2014) progress in ICT results in distance or distance deaths being less influential in trade, because there is no need for meetings or face to face because it has been replaced by telephone, e-mail and other means of telecommunication.

Furthermore, Abidin et al. (2013), they analyze the effect of Malaysian exports on OIC countries by using panel regression and gravity models during the 1997-2009 period. At the one percent level of significance, openness has a significant and positive impact on export. For distance it is found significant but has a positive sign, that is, on the contrary to the logic of the gravity model. Amador and Cabral (2008) find that technology and types of goods have great influence on country decisions (importer) in buying goods from the exporting country. Simorangkir (2006); and Iskandar (2006) show that, trade openness has a negative influence on output growth in Indonesia, this is due to lack of preparation or anticipation policies so that domestic industrial products cannot compete with foreign products. Dlamini et al. (2016) in his study which analyzed the effect of Swaziland sugar exports on 24 partner countries using panel regression and gravity models over the period 2001-2013 found that openness / openness of Swaziland and destination countries had a negative and significant impact on sugar exports, then the GDP of destination countries also had negative and significant impacts on exports. Beseses and Byle (2010) in their study explain in Latin America that the duration of exports is an important factor in influencing the demand for export of importing countries in the long run.

Amador and Cabral (2008) found that technology and types of goods greatly influence the decisions of importing countries in buying goods from exporting countries. Next is a study from Afolabi, Aziz & Bakar (2016) who analyzed the general impact of the ECOWAS regional integration agreement on bilateral trade using gravity model. The results show that distance has a negative and significant relationship on trading volume between 15 ECOWAS countries. This result is in line with the gravity model. Then, trade openness or openness also has a negative and significant relationship and for the GDP variable has a positive and significant sign

Reasearch Frame work

In this discussion, the author will explain the research model which is the rationale for examining export relations with independent variables in the model. Furthermore, information about the research model is as follows

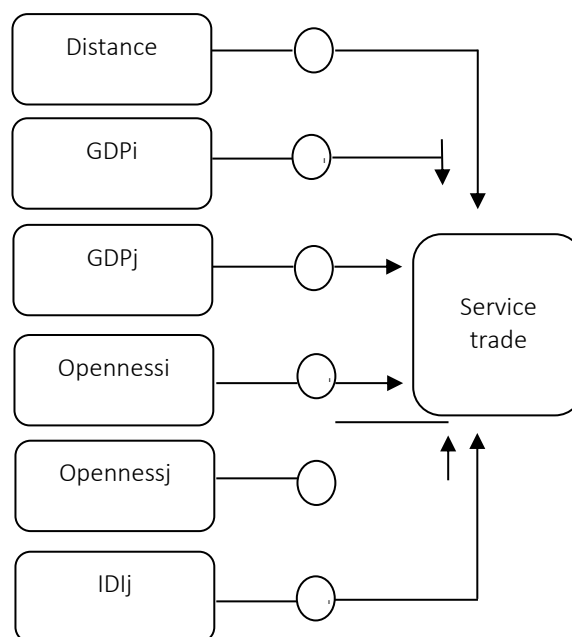

. From the previous frame of mind, the writer wants to examine whether the distance between countries, country of origin GDP, destination country GDP, open country of origin, openness of destination countries and ICT-IP affect service exports.

III. METHODOLOGY

The data are used in this study, are secondary data obtained from several reliable sources such as UN-COMTRADE (www.comtrade.un.org) for service trade data. Data of distance between countries are obtained from www.distancefromto.net. The World Bank (WB) is for the data of GDP and openness of reporter and partners. Also, International Telecommunication Union (ITU-United Nation) for the data of Information and Communication Technology (ICT) Development Index so-called IDI. Employing panel data, the analytical tool Stata 13 is used in this research. The observation is the 10 main countries service exporters to Indonesia, such as Singapore, Australia, USA, Netherlands, Canada, UK, Luxembourg, Belgium, Iceland and Slovakia in 2012 to 2016. Ten countries were selected as samples in this Study because 10 countries were highest in exporting services regularly to Indonesia in the last 5 years.

This analysis method includes panel data regression analysis with gravity models. The panel data is a combination of time series data and cross data. Timed data includes several periods such as daily, monthly, quarterly, or yearly. Regression model of ICT in this study is presented as follow:

$$\text{LogExijt} = a + b_1 \log \text{Distit} + b_2 \log \text{GDPit} + b_3 \log \text{GDPjit} + b_4 \text{Opnsit} + b_5 \text{Opnsjt} + b_5 \text{IDIit} + eijt \dots \dots \dots$$

Where:

- Exij : Service Export (Million USD)
- a : Constant
- Dist : Distance (miles)
- GDPi : GDP of reporters: 10 countries (million USD)
- GDPj : GDP of partner: Indonesia (million USD)
- Opnsi : Openness of reporter (%)
- Opnsj : Openness of partner (%)
- IDIi : ICT Development Index
- e : Term Error
- t : Time (year)
- ij : Country

A. Definition of Operational Variables

1. Export

The export variable was chosen as the dependent variable in this study. Exports are sales of goods and services from within the country that are sold abroad using the payment system, quantity, quality and other sales conditions that have been approved by the importer and exporter. Data is taken from UN-COMTRADE in 2012-2015 and is calculated in units of million USD

2. Distance

The distance variable in this study is the distance from the country of origin to Indonesia which is calculated in miles. Distance is measured by air between the capitals of the two countries. Data is obtained from www.distancefromto.net

3. GDP of reporters

The GDP of the country of origin in the study is income derived from countries of origin, namely Singapore, Australia, USA, Netherlands, Canada, UK, Luxembourg, Belgium, Iceland and Slovakia, including income obtained from foreign-owned production factors, expenditure on total goods and services produced in a constant from.

4. GDP of partner

The GDP of the destination country in the study is the income earned by the State of Indonesia, including income obtained by foreign-owned production factors, expenditure on the total goods and services produced in a constant from .

5. Openness of reports

In this study openness is a trade openness figure from 10 exporting countries, namely Singapore, Australia, USA, Netherlands, Canada, UK, Luxembourg, Belgium, Iceland and Slovakia. Data is taken from the World Bank in 2012-2016.

6. Openness of prtner

In this study openness is a number of trade openness from Indonesia. Data is taken from the World Bank in 2012-2016.

7. ICT Development Index (IDI) of reports

, In this study IDI is an Information and Communication Technology Development Index from 10 exporting countries, namely Singapore, Australia, USA, Netherlands, Canada, UK, Luxembourg, Belgium, Iceland and Slovakia. Data is taken from the International Telecommunication Union (ITU) in 2012-2016.

IV. RESULT AND ANALYSIS

There are three tests that can be done to choose panel data estimation techniques according to Widarjono (2007). The first step is to select the model that is done by means of the F-statistic test or the chow test to select the common effect or fixed effect to be used. If the result of the F-statistical probability in the chow test is smaller than 0.05, Hausman test will be conducted. The second step is the Hausman test to choose the fixed effect method or random effect. If the probability of the Hausman test is less than the significance level of 0.05, then the fixed effect is chosen, but if the Hausman test probability value is more than the 0.05 level, then the random effect will be selected. Third, the Lagrange Multiplier (LM) test is performed to choose between the common effect method and random effect. If the LM value is smaller than the Chi-Squares critical value, the chosen model is the common effect.

Based on the regression results of the model selection that has been done, the chow test shows that Fixed Effect is a better model compared to the Common Effect. However, in the subsequent regression the Hausman test shows that Random Effect is a better model than Fixed Effect, this is supported by the Lagrange Multiplier (LM) test whose results show that the Random effect is better to use. After doing some statistical tests on what models will be used in the study, it can be concluded that the Random Effect model will be used in this study. The following are the estimation results from this study:

Table.1 Estimation Results

Variabel Dependent: Exijt	Model		
	Common Effect	Fixed Effect	Random Effect
Konstanta	320.548	145.102	257.840
Standar Error	(134.803)	(0.029)	(73.127)
P-Value	0,022	0,151	0,000
Logdist	-1.306*	(omitted)	-1.386**
Standar Error	(0.184)	(omitted)	(0.472)
P-Value	0.000	(omitted)	0.003
Loggdpi	1.382*	4.935	1.253*
Standar Error	(0.080)	(3.909)	(0.194)
P-Value	0.000	0.215	0.000
Loggdpij	-11.793**	-9.290**	-9.360*
Standar Error	(4.784)	(3.441)	(2.602)
P-Value	0.018	0.011	0.000
IDI	0.088*	0.029	0.055**
Standar Error	(0.010)	(0.029)	(0.020)
P-Value	0.000	0.332	0.007
Opnsi	0.008*	0.001	0.005***
Standar Error	(0.001)	(0.005)	(0.003)
P-Value	0.000	0.726	0.065

Opnsj	-0.128**	-0.854	-0.105**
Standar Error	(0.070)	(0.037)	(0.035)
P-Value	0.022	0.151	0.003
R-Squared	0.9036	0.5195	0.8774

Source: The Results of panel data processing using stata

Note : *p<0.01; **p<0.5; ***p<0.10

. Based on the regression results above, we find that, all variables can explain service trade flow by 0.8774 is indicated by R-Squared. From our estimation results, this study reveals that, distance has a negative and significant effect on service exports to Indonesia at the confidence level of 5%. The distance coefficient value is -1.386, which means that, there is 1% increase in distance between countries at the confidence level of 5%, then service exports to Indonesia decrease at about 1.386% holding other variables constant. This explains that the distance factor becomes very important in influencing service exports to Indonesia. The farther the distance between countries will cause the reduction in the number of service exports to Indonesia. This is consistent with the research conducted by Li, Song and Zhau (2008) which defines that economic distance is the distance that represents the transportation costs by a country when conducting trade activities. Distances affect trade between countries in the form of decreasing trade, the farther the distance, the greater the transportation costs incurred, the lower the export volume. Although according to Detter (2014) the progress in ICTs has caused distance or distance deaths to be less influential in trade because there is no need for meetings or face-to-face meetings because they have been replaced by telephone, e-mail and so on. However, in this study the distance still has an influence on service exports even with a low value.

The GDP of reporter also has a positive relationship to service exports to Indonesia. Therefore, at 5% confidence level, every increase in 1% of GDP of reporter will increase service exports to Indonesia by 1.253%. Similar to the research conducted by Nath (2016), he argues that, the GDP of the country of the origin has an influence on service exports. This is in accordance with the theory that there is a positive relationship between the GDP of the country of origin and the export made. It can be explained why the influence of GDP on exports through the concept of vent for surplus as stated by Adam Smith, where exports have to do with surplus or excess results of domestic production output, because the increase in production surplus which is usually marked by GDP growth will encourage increased exports due to excess domestic output will then be channeled through exports.

The next variable is GDP of country partner that has a negative relationship on service exports to Indonesia. Therefore, for 1% degree of confidence, 1% increase of GDP's partner will decrease service exports to Indonesia by 9.360%. According to Sukirno's theory which states that the increase in GDP will increase the total income per capita which has an impact on increasing consumption, conversely if the GDP obtained by a country goes down it will reduce income per capita, so that the ability to buy the desired goods and services will decrease (Sedyaningrum, Suhadak and Nuzula 2016). However, according to Adi (2017) on the other hand an increase in a country's per capita income will also increase the ability of the community to carry out the production process so as to encourage people to export to other countries.

The openness variable of reporter has a positive and significant effect on service exports to Indonesia. Therefore, for each 10% degree of confidence, 1% increase in openness will increase service exports to Indonesia by 0.005%. This is in line with the research conducted by Abidin, Bakar and Sahlan (2013) which states that openness has a positive and significant effect on exports. This is illustrated by efforts to promote free trade such as the elimination of quotas, rationalizing subsidies or it could be by reducing trade taxes. In contrast, the openness of country partner have a negative and significant onservice exports to Indonesia. Consequently, for each 5% degree of confidence, 1% increase on openness will decrease service exports to Indonesia at 0.105%. This result in consistent with the theory of Simorangkir (2006) and Yanikkaya (2003) which states that trade openness is a measure of economic openness policy that aims to control international instruments, the instrument is an effort to prevent economic dependence which will ultimately damage the dynamics of the national economy. Dependence in question is dependence on imports and dependence on foreign capital. The last variable is IDI which has a positive and significant on service exports to Indonesia. At each 5% degree of confidence, 1% increase in IDI will increase service exports to Indonesia by 0.055%. This is in accordance with Liu's (2016) study which says that IDI has a positive and significant impact on trade.

CONCLUSION

This study aims to determine the effect of Information and Communication Technology (ICT) on service trade to Indonesia. Based on estimation results, ICT has positive and significant effect on service exports. While the variable distance between countries has a significant negative effect on service exports. This results explain that the farther the distance between the two countries will cause a reduction in the amount of service exports to Indonesia. Then the variable GDP and the openness of reporter have positive and significant effect on service exports. This explains that, the higher the GDP and the openness of country reporter, the higher the number of service exports of 10 countries to Indonesia. When country reporter's GDP is increasing, this will encourage the reporter to export to Indonesia, and with the existence of high openness, this create efforts to promote free trade such as eliminating quotas, rationalizing subsidies also reducing tariffs. GDP and openness of country partner, both have negative and significant effect on service exports to Indonesia. This explains that the higher the GDP of Indonesia, the lower the number of services exported to Indonesia and the higher the openness of the country of Indonesia, the lower the number of services exported to Indonesia.

REFERENCES

- [1] Abidin, I, Bakar, N, & Sahlan, R. 2013. The Determinants of Exports between Malaysia and the OIC Member Countries: A Gravity Model Approach. *Procedia Economics and Finance*.
- [2] Amador dan Cabral. 2008. The Portuguese Export Performance in Perspective: A Constant Market Share Analysis. *Economic Bulletin and Financial Stability Report Articles and Banco de Portugal Economic Studies*, Banco de Portugal, Economics and Research Department.
- [3] Anderson, J. E. 2016. *The Gravity Model of Economic Interaction*. Boston College.

- [4] Baltagi, B. H. 2005. *Econometric Analysis of Panel Data*. 3rd Ed. West Sussex: John Wiley and Sons Ltd.
- [5] Barro, R. J. 2003. Determinants of Economic Growth in a Panel of Countries. *Annals of Economics and Finance*.
- [6] Besedes, T. and Blyde T. 2010. What Drives Export Survival? An Analysis of Export in Latin America. Inter-American Development Bank, mimeo, 1- 43.
- [7] Blyde T. 2004. Trade and Technology diffusion in Latin America. *The International Trade Journal*, Vol.18, No.3, pp. 177-197.
- [8] Dettmer, B. 2014. "International Service Transactions: Is Time a Trade Barrier in a Connected World?" *International Economic Journal*, Vol. 28, No. 2, pp. 225-254.
- [9] Dlamini, S. G. et al. 2016. Determinants of Swaziland's Sugar Export: A Gravity Model Approach. *International Journal of Economics and Finance*, Vol. 8, No. 10, pp. 71-81.
- [10] Gujarati, D. R. 2006. *Dasar- dasar Ekonometrika*. Jilid 1. Alih Bahasa Julius Mulyadi. Erlangga Jakarta.
- [11] Jhingan, M. L. 2000. *Ekonomi Pembangunan dan Perencanaan*, Penerjemah: D. Guritno, Edisi Pertama, Jakarta: PT Raja Grafindo Persada.
- [12] Li, X., Greenaway, D. and Hine, R.C. 2003. Import of Services and Economic Growth: A Dynamic Panel Approach. Sustainable growth, Employment creation and Technological Integration in the European knowledge-based economy (SETI), University of Nottingham.
- [13] Li, Song, Zhou. 2008. *Component Trade and China's Global Economics Integration*. United Kingdom: United Nations University.
- [14] Liu, L. and Nath, H. 2016. "Information and Communications Technology (ICT) and Services Trade", Sam Houston State University, Department of Economics and International Business Working Paper No. 16-01 January.
- [15] Linneman, H. 1966. *An econometric study of international trade flows*. NorthHolland. Amsterdam.
- Pain, N. (1996). Continental drift: European integration and the location of UK Foreign Direct Investment. NIESR Discussion Paper 1007, National Institute of Economic and Social Research.
- [16] Mankiw, G. H. 2007. *Makroekonomi Edisi ke-6*. Jakarta: Erlangga: Gelora Aksara Pratama.
- [17] Mohsen, A. S. 2015. Effect of Exports and Investment on the Economic Growth in Syria. *International Journal of Management, Accounting, and Economics*. Vol. 2, No. 6.
- [18] Montgomery, D. C., Peck, E. A., Vining, G.G. 2001. *Introduction to Linear regression Analysis*, 3rd edition, Wiley, New York
- [19] Nachrowi D. N. 2006, *Ekonometrika, untuk Analisis Ekonomi dan Keuangan*, Cetakan Pertama, Jakarta: Lembaga Penerbit FE UI.
- [20] Ozcan, B. and Nath, H. 2016. "Information and Communication Technology (ICT) and International Trade: Evidence from Turkey," Working Papers 1609, Sam Houston State University, Department of Economics and International Business.
- [21] Putri, N. H. 2017. Analisis Pengaruh PDB dan Kurs Dollar Amerika Terhadap Neraca Perdagangan Melalui Foreign Direct Investment di Indonesia Tahun 1996-2015. *E-Jurnal EP Universitas Udayana*, Vol. 6, No. 9.
- [22] Sedyaningrum, M., Suhadak and Nuzula N. F. 2016. Pengaruh Jumlah Nilai Ekspor, Impor dan Pertumbuhan Ekonomi Terhadap Nilai Tukar dan Daya Beli Masyarakat Di Indonesia Studi Pada Bank Indonesia Periode Tahun 2006: IV-2015: III. *Jurnal Administrasi Bisnis*, Vol. 34, No. 1.
- [23] Sukirno, S. 2012. *Makroekonomi Teori Pengantar*; Edisi Ketiga. Jakarta: Rajawali Pers.
- [24] Simorangkir, I. 2006. The Openness and Its Impact to Indonesian Economy: A SVAR Approach. Center for Central Banking Education and Studies, Bank Indonesia, Jakarta.
- [25] Spero, Joan, E. and Jeffrey A. H. 2003. "International Trade and Domestic Politics", *The Politics of International Economic Relations*. Boston: Wadsworth.
- [26] Yanikkaya, H. 2003. Trade Openness and Economic Growth: a cross-country empirical investigation, *Journal of Development Economics*, Elsevier, Vol. 72, No.1.
- [27] Tinbergen, J. 1962. *An Analysis of World Trade Flows in Shaping the World Economy*, edited by Jan Tinbergen. Twentieth Century Fund. New York.
- [28] Vemuri V.K. and Siddiqi, S. 2009. "Impact of Commercialization of the Internet on International Trade: A Panel Study Using the Extended Gravity Model" *The International Trade Journal*. Vol. 23 No.4, pp. 258-484.

Benefits of Football Competition in the Economy of Traders in Surajaya Stadion Lamongan

Fahmi Anas

Student Master on Department of Sociology

Faculty of Social and Political Sciences, Airlangga University Surabaya, Indonesia

Email: Anasf412@Gmail.com

Abstract— *Football is one of the most popular sports in society. People could enjoy football games through television or see it directly at the stadium. Football has a huge impact on the economy. Football benefit society, especially a group of traders who are in Indonesia. Merchants can take advantage and benefit of the presence of football competition in the field of economy. The methods used in this study is descriptive qualitative. The informants in this study are Surajaya Stadium traders. The process of collecting data through observation, interviews and the literature review. Techniques in analyzing data using interactive data collection and presentation of data. The theory used to analyze is of George Homans Exchange theory. The findings from the data in this study there are several variations of data about football and economy, through success and stimulus proposition. The findings from the interviews, it was discovered that, football in the stadium Surajaya was able to increase revenue for the Group of merchants, ranging from food, beverages, accessories and jersey. Traders choose Open lapak selling around the stadium felt getting a lot of profit. Traders choose to open stalls selling around the stadium because of the enthusiasm of the people who come to see football matches at the Stadium Surajaya.*

Keywords— *Football, Economy, Traders.*

I. INTRODUCTION

Sport is a human creation and nature. More than that, sport is the creation and manifestation of the humanity. Therefore sports should be increased into culture and even civilization [1]. Sport continues to evolve beyond just a physical activity, rather be it becomes a place of refinement of human mind which exudes honesty, justice, fighting spirit, readiness, sacrificial, hard work and sportsmanship[2].

Sport is a serious business and opens up many jobs. Many organizations always pay attention to sports statistics with economic activities. For example, in February, the European Central Bank published a report on the volume of stock trading during a football match at the 2010 World Cup. The result? The average volume of trading in the stock in a country down by more than 50 percent during the match involving the national teams of the country.

Football is one of the most popular sports in the world, soccer has become an industry in the modern era. That is

what helped make everything about football crowded by the public. Football is not just a game of scoring wins and losses, football is more than that, it contains drama about humans and life. Football is considered the most appropriate to unite a multicultural society. Football is used as a means of discussing differences in ethnicity, nation, race, language, culture, and soon.

Football can be used as a medium to encourage economic growth. In addition in terms of marketing, entertainment, and the sale of the broadcasting rights that provide advantages for the organizers, soccer is also often used as a tool of nation's adhesion and a multiplier of society nationalism which will later encourage a country's economic. This is the reason of a football competition, particularly in Indonesia. Football competitions in Indonesia has an important role in economic activities.

Professional football competition creates enormous job opportunities for soccer players, businessmen, culinary entrepreneurs, t-shirts or convection entrepreneurs, transportation entrepreneurs, hotel or lodging entrepreneurs, and other economic principals. Through the determination of professional football competition in Indonesia clearly has an influence on economic and social welfare of Indonesian people[3].

Many Indonesian people are interested in football. Football in the value of being able to provide entertainment for the community. Football in Indonesia had long been contested. League 1 competition (Indonesia Premier League) often called Liga 1, has been going well and has attracted quite a lot of audiences. The competition guarantees the economic life of football players, referees, administrators, ticket sellers, sellers of accessories, drivers, hotels, parking attendants, and those involved in the business of providing field, vehicles, and all the kind of things related to football.

A football game gives excitement for football lovers. After being observed and it turns out that football has a significant influence, for the lower middle class people and merchant groups. A group of traders feel at lot more profitable by football tournament, especially a group of merchants who sell around the stadium. Crowded community a lot of market demand, utilized as much as possible in the morning a group of traders to benefit by selling around Surajaya Stadium in Lamongan.

Surajaya Stadium is strategic for public riders, on the side of the Surajaya Stadium has a rest area and place of worship. The strategic location of Surajaya Stadium make the group of merchants choose to build stalls for selling,

such as the sale of clothing, accessories, and food, but on a typical day, the stadium seems deserted and the merchant groups lacked income or profits on ordinary days. Activities and realities at Surajaya Stadium in Lamongan will look different when there is a football competition, the crowd and the density of vehicles and people who come to see football matches, making groups of traders interested in opening stalls to sell.

Surajaya Stadium is one of the homebased of Indonesian Football Club, namely Persela Lamongan. When Indonesian League competition started the competition, Surajaya Stadium Persela is the place to hold matches. At the time Persela competed to make the main attraction for the group of traders to open a booth selling around Surajaya Stadium. The name persela has attraction for traders and people to come to Surajaya Stadium. Surajaya Stadium is crowded by people carrying attributes and t-shirts with the color of the greatness Persela Lamongan, which is light blue.

A group of merchants who sell around Surajaya Stadium is an average group of traders who sell food and beverages, supporters accessories, jersey or football shirts. The accessory and jersey merchant groups certainly sell all their identifiable merchandise or the distinctive features of the Lamongan Persela team, all the kinds in light blue. Community or group of supporters who come to the stadium to see football will certainly take advantage of time to buy accessories and bring it into the stadium to support their pride team (Persela Lamongan). Crowded people or group of supporters who arrived at the stadium, certainly made it easier for the merchant groups to benefit from the results of its economic activities.

The ongoing football performances at Surajaya Stadium, make traders feel lucky with the football tournament. Football tournaments at Surajaya Stadium make people come to see football matches being contested, the presence of the community or football supporters providing distinct advantages for the group of traders, of course this is a tradition for merchant groups, this kind of activities are used by merchant groups around Surajaya Stadium Lamongan.

Traders felt benefited by many people who come to the Surajaya Stadium. The crowd at the stadium certainly makes the opportunities for demand and sales increase from in the usual day. The crowd of football performance took place; it is time for the opportunity for merchants to reap good profits from the sale of shirts, accessories or food and beverages.

The situation will turn around if the Surajaya Stadium does not have a football match, without football performances at Surajaya Stadium, groups of traders who are around the stadium would find it difficult to make a profit. This is one of reasons the author interested in writing about football and the economy through the theory of social exchange George C Homans, where the football competition in Indonesia is able to provide benefits for the economy especially for a group of traders.

II. RESEARCH METHODS

Based on its objectives, this study belongs to empirical research and uses quantitative methods. This method is expected to be able to test hypotheses, by examining the relationship between global economic variables on SUN and SBSN and looking for differences in the effect produced by the dependent variable on the two independent variables studied. This study uses a multivariate regression model with the ordinary least square (OLS) equation.

Data and variables

The research variables that will be processed using data as summarized in the table 1 below:

Table 1. Description Variables

Variables	Description
SUN (SUN)	The SUN total return index provided by IBPA is the return from tradable SUN series in Rupiah.
SBSN (SBSN)	The SBSN total return index provided by IBPA is a return from tradable SBSN series in Rupiah.
Global Reference Rate (FFR)	Global Reference Rate in this case the Fed Funds Rate provided by the Federal Reserve which is the United States central bank (percentage)
Rupiah Exchange Rate Against US Dollars (KURS)	Rupiah Exchange Rate Against US Dollars provided by Bank Indonesia (Rupiah/USD)
world oil prices (OIL)	West Texas Intermediate/WTI world oil prices provided by NYMEX (USD/barrel)
World gold prices (GOLD)	World gold prices provided by COMEX (USD/troy ounce)

The total SUN return index (INDOBeX Total Government Returns) and the Total SBSN Return Index (Indonesian Government Sukuk Index / IGSIX Total Returns) provided by the Indonesia Bond Pricing Agency (IBPA). This index describes the movement of the rate of return of the entire bond where the calculation is based on the increase or decrease in bond prices, accumulated coupons, and return of annual coupons that are reinvested so that the index is more accurate in describing the performance of bonds (Indonesia Stock Exchange & Indonesia Bond Pricing Agency, 2018).

In order to explain the interest rate, this paper use the Federal Funds Rate (FFR) issued by the Federal Reserve

which is the central bank of the United States. The Fed Funds Rate is the base interest rate for commercial bank activities and FFR is the interest rate charged by banks to other banks for overnight loans with nominal \$ 1 million or more (Jordan, Miller Jr, & Dolvin, 2012). The Fed

The method used in this study is qualitative descriptive. Qualitative research is a special research object that is not precisely researched statistically or quantitatively. In this research researchers try to illustrate how the benefits of football competitions on the traders economy, methods and types of research are expected to help explain in detail the benefits of football competitions on traders In Lamongan Surajaya Stadion. The informant in this research is a traders who sells around Surajaya Lamongan Stadium. For more details traders of food and beverage traders, T-shirts or Jersey, and accessories traders. The data collection process uses two types namely primary data and secondary data. Primary data is obtained through observation and interviews. Observation stage, perform observations as a first step to know how the activities that occur related to the merchants who sell around Surajaya Lamongan Stadium. Observations were observed in the activities of traders selling around Surajaya Lamongan Stadium. Interviews, researchers conducted a live interview with a trader who sells around Surajaya Lamongan Stadium, researchers ask questions about subjects that are specified to get an answer or data directly through questions and answers with group traders. Secondary data obtained from various literature studies supporting the book, journals, articles and other data related to the theme of the study. The technique of conducting interactive data analysis is data collection and data presentation then, the data that has been analyzed, is interpreted with the theory used in this study, which then resulted in the proposition used to assist and directing in the process of drawing conclusions. The location of this research is located at Surajaya Stadium, Homebase team Persela Lamongan.

III. DISCUSSION OF RESULTS

The actors in this study are a group of traders, of course the researchers will discuss the reality and interactions performed by traders around Surajaya Stadium using the George C Homans exchange theory. The exchange seen in this phenomenon is the interaction made by the group of traders with the community or support group at Surajaya Stadium when there is a football game. Interaction of traders with the community is seen as an economic activity or buying and selling, a group of traders as sellers and communities as buyers. Interactions between traders and communities are exchanges, which are characterized by traders earning money from proceeds, while the public gets goods from the proceeds of purchase.

From the outcome of the field data, the trader chooses to open a stall around the stadium certainly not without reason, the reason traders choose to sell around the stadium at the time of the competition because they see the group Soporuter who came watching football Match (Persela). In this section, we will explain the results of the research and discussion on the benefits of football competitions for traders at the Surajaya Lamongan Stadium. Here I will link

the findings of the field using social exchange theory. There are two types of proposition according to the researchers to review the problem of football competition benefits for traders in the stadium Surajaya Lamongan. he first is a successful proposition and the second is the stimulus proposition.

1. Proposition a Success

Like what is said by George C Homans in his book, "If a person often commits an action and the person earns the reward of what he or she does, the more likely he will do it in the future". In general the behavior that aligns with the success proposition includes the three stages i.e. first person action, both results are rendered and third repetition of the original or minimal action action that is in some respects resembles the original action.

If the success proposition of George C Homans is attributed to the results of the field of discovery, merchants opening stalls and selling around Surajaya Stadium are actions such as what Homans mean in his theory, traders choose to sell in Surajaya Stadium because traders feel the choice is able to give their own advantages and benefits for them. This advantage is what makes a tendency for the group of traders to always choose to open stalls and sell in Surajaya Stadium at the time of football matches. Such Momentum is utilized by traders, because the football matches in the stadium Surajaya not every day in the match, but one time in two weeks.

Profits and revenue generated Group of traders is increasing if compared upon opening the same in other places, this is what makes a Group of traders chose the side of the stadium that made sellers to trade especially during Festival the football competition. The large number of supporters who came to see football utilized traders to profit. A Group of traders who sell on the side of the stadium is Surajaya varies, but the traders groups feel in have an advantage with the choices that have chosen Surajaya Stadium in trade at the time of entry for the football competition. The number of society flocked to see football, exploited by a group of traders to sell around the stadium where able to improve sales results wares in profit.

Like other traders selling food and drinks. Food and drink one of the much-needed goods by spectators or supporters at the sight of soccer. A football game that is long enough to make sure the audience in search of food and drinks to enjoy breaks half time. Chance like this are utilized traders of food and beverages. Food and beverage traders Chosen an immediate trip down all the way to the corner of the stadium in offering food and drink merchandise, however, and there are also traders who chose to stop in one place. traders along the stadium's average drink vending mineral water, ice, coffee and snack foods such as tofu, lumpiya, beans and rice wrap. While the food traders to stop in one place are those groups of traders who sell food such as chicken soup rawon, lively coffee shop and became the resting place of the audience did not enter the stadium.

Each trader has its own way and differs in promoting his trades, if the group of food and beverage merchants sell by going through the stadium, so it is different from

the group of accessories and jersey merchants, accessories traders and Jersey stopped at one place, they selling is on the outside of the stadium Surajaya Lamongan, so not the trader who came to Costumer, but costumer who came to the place of traders selling accessories and jersey. A group of Jersey traders saw an increase in Jersey sales if selling at the stadium when there was a football show, this is the choice for traders to sell in the Surajaya stadium. Like what George C Homans said in his success proposition, the group of traders choose to sell or open the stalls around Surajaya Stadium at the time the football competition takes place is an action they choose with the purpose of obtaining profit or reward from their buying and selling activities. Knowing the advantages and rewards they get is very significant, making traders utilize the momentum of football competition to always open the stalls and sell in the stadium Surajaya Lamongan.

2. The Proposition of Stimulus

What is said by Goerge C Homans in his book, If in the past there is a certain stimulus, or a series of stimuli is a situation where a person's actions are rewarded, it is increasingly similar to the current stimulus with the stimulus of the past The greater tendency of the person repeats the same or similar actions.

With a experience experienced directly by the traders when opening the field and selling around Surajaya Stadium is certainly able to assess how rewards and profits when selling at the time of ' football performances in the Surajaya Stadium. Traders are able to assess that the football performances in the Surajaya Stadium are able to invite and attract the community widely to come saw football matches in Surajaya Stadium.

Crowded of football matches and the high the of the public is certainly used massively by a group of traders, one of which is a group of accessories traders. The group of accessories traders is also interested in opening a trade stalls around Surajaya Stadium when there is a football game in the stadium. The group of accessories sells varies from Club flags (*Persela*), *Shal*, *doll and trumpet*. Sell the accessories of Surajaya Stadium when the football performances are certainly not without reason.

The group of accessories traders see the opportunity of big profit when selling club accessories around the stadium when there is a game persela as a host, a lot of supporters or LA Mania before entering the stadium bought shal, trumpet and flags that Later in use to support teams in the competition. These habits of LA mania or supporters of Persela are utilized by the group of accessories traders so they are interested in opening a trading stalls when there is a football game in the Surajaya Stadium. This is what makes the trader choose to open the stalls and sell around Surajaya Stadium at the time of football competitions, many advantages or rewards they get.

Football matches are certainly capable of attracting many supporters or communities, in the world of football called supporters or fans. The number of supporters who come to see football are used by traders to earn profit. The football competition that took place at Surajaya Stadium was able to increase the income of the group of merchants

selling around Surajaya Lamongan Stadium. The group of traders found it helpful and benefited by the football performances at the stadium Surajaya Lamongan.

Earnings and rewards are earned by traders when selling in the Surajaya Stadium in the sense of being able to give profit, therefore the tendency of traders to always open the stalls and sell at Surajaya Stadium at the time of the match Football. Tim Persela Lamongan As the host, the tendency of traders to sell jersey and distinctive accessories is the main choice to be traded, although there are some other jersey such as the Insonesia national team jersey.

Surajaya Stadium is a homebase of the team of Persela Lamongan, of course, jersey traders selling Persela Lamongan jersey, it is able to attract the community or the audience who come to the stadium. In addition to selling jersey Persela Lamongan, traders also sell the Jersey national team of Indonesia. Traders are able to see profit opportunities when selling at Surajaya Stadium, they sell jersey or product from home team or Persela so that the support group is interested to buy a jersey Persela. Selling the Persela jersey is certainly an option that is deemed appropriate for the trader to be able to gain profit.

The characteristic and identity of the team Persela Lamongan is a light blue color, certainly the accessories that are sold by the traders of light blue accessories as the greatness of the team Persela Lamongan, either shal, slayer, or flag. As with jersey sales, traders are more likely to choose a trade jersey. Traders choose this action by looking at the animo and enthusiasm of the militant supporters of Persela, so it is a big one for traders to reap profits.

The target of the jersey sale market is not just for adults, a variety of sold jersey ranging from small children to adults, from a price of one hundred thousand to thirty thousand. Traders look other than adults who come to see football, small children also flock to see a football game, this is why traders sell jersey with varying size and price, certainly following market demand or costumer.

As said by George C Homans about the stimulus proposition, the stimulus that occurs in the group of traders is characterized by the profit or income they get when there is a football match in the stadium Surajaya, the number of Community or supporters who come to the stadium Surajaya in the use of a group of traders to sell or open stalls in the stadium Surajaya, this is what makes the trend of the group of traders always open stalls and sell around Stadium at the time of the football competition.

REFERENCES

- [1] Agger. Ben's. (2014). *Critical social theory, criticism, applicability and Implications*. Yogyakarta: Creative Discourseoffsets.
- [2] Dr. Afriwardi, SP. KO. (2010). *Sports Medicine*. Jakarta: Medical book publishersEGC.
- [3] Goodman, Douglas J, Ritzer, George. (2011). *Theory Of Modern Sociology*. Jakarta: Kencana MediaGroup.

- [4] Irpani, Edi. (2014). *The Phenomenon Of Crazy Ball*. Bandung: Oasebuku. Jones, Pip. (2009). Introduction to Social theories, from Functionalism to Post-modernism. Jakarta: Yayasan OborIndonesia.
- [5] Kennedy, S Eddward. (2014) *One Thousand Football Tafsir*. Yogyakarta: Indie BookCorner.
- [6] Kristianto, Eco Noer. (2016). *The role of national laws in implementing Competition Profesional FootallinIndonesia, the National Law Journal Media Coaching, 05 (03).447*.
- [7] Pandjaitan, IP Hinca. (2011). *State Sovereignty VS. Sovereignty FIFA*. Jakarta: PT Gramedia PustakaUtama.
- [8] Rahmani, Mikanda. (2010). *The complete book of Super sports*. Bandung: a world ofsmart.
- [9] Raho, SVD, Bernard. (2007). *The Theory Of Modern Sociology*. Jakarta: The achievements of thelibrary.
- [10] Rirzer George. (2011). *The Theory Of Sociology*. Bantul: Creative Discourse offsets. Ritzer, George. (2013) *Sociology Of Science the double paradigm*. Jakarta: Eagle Press. Sugiyono. (2010). *Understand Qualitative Research*. Bandung: CV. ALVABETA.
- [11] Tono Suratman. (2016). *National sports strategy for the 21st century*. Jakarta: Eagle Press. Suwandi & Basrowi. (2008). *Understanding Qualitative Research*. Jakarta: RinekaCopyright.
- [12] Yahya, Khoirul. (2013) *The Theory Of Politics*. Surabaya: IAIN Sunan Ampel Surabaya, Surabaya.

The Competitiveness of Indonesian Cocoa Product and Their Derivates in the International Market

Istis Baroh
 Agribusiness
 University of Muhammadiyah Malang
 Malang, Indonesia
istis@umm.ac.id

Abstract – This study aims to analyze the competitiveness of Indonesian cocoa between its several derivate products from 2006 to 2015 of two importing countries. Germany and The USA are chosen as the representative of the international markets because of three reasons. First, those two countries are the most prospective markets of cocoa products. Second, they consume large amount of cocoa processing products for their Industries. Third, as the core players of trade, they always import processed cocoa products from Indonesia in the past decade. We use Revealed Comparative Advantage (RCA) approach to analyze the competitiveness of processed cocoa products, followed by Revealed Symmetric Comparative Advantage (RSCA) approach to avoid upward-biased problems from the previous steps. RSCA enables us to manipulate the RCA index to be symmetrical with interval values between -1 and +1 (Prasad, 2004). The results showed that in Germany, cocoa paste products and cocoa butter the two products that have high competitiveness, whereas cocoa powder was not competitive. In the USA, Indonesian cocoa butter was competitive while cocoa paste and cocoa powder were not competitive. Indonesia should focus on cocoa paste and cocoa butter to maintain their competitiveness through pricing, contract negotiations, and trade relations.

Keywords: cocoa, competitiveness, international market.

PRELIMINARY

Indonesia is one of the world's leading producers of cocoa. The total area of Indonesian cocoa plantations is 1.4 million hectares with a production of approximately 500 thousand tons per year, placing Indonesia as the world's third largest producer country after Ivory Coast (Ivory Coast) and Ghana. Ivory Coast with an area of 1.6 hectares and production of 1.3 million tons per year and Ghana at 900 thousand tons per year. In the world, there are around 50 countries producing cocoa plants, including those in 3 continents, namely Africa (65%), Asia (20%) and Latin America (15%). Indonesia is ranked seventh in the world under the Netherlands, America, Germany, Ivory Coast, Malaysia, and Brazil when viewed from the side of the cocoa processing industry. The area of cocoa plantations in Indonesia has continued to increase over the past 5 years. Thus, the opportunity to increase cocoa production is still wide open, including increasing the added value of products from cocoa (Ragimun, 2012).

The government has implemented export costs for cocoa beans with the aim of tightening the release of cocoa commodities in the form of seeds or raw materials. Minister of Finance Regulation Number 67 / PMK.011 / 2010 concerning the determination of export goods subject to export duty states that export goods subject to export duty

are rattan, leather, timber, oil palm, Crude Palm Oil (CPO) and derivatives, and cocoa beans. This policy is one of the strategies for cocoa beans to be processed into finished or semi-finished products before being sold to international markets. Syadullah (2012) found that there was a clear causal relationship between the implementation of the Export Duty (BK) policy and the increasing domestic cocoa processing industry. Since the implementation of BK, the export of cocoa beans has decreased significantly.

According to Syakir, et al (2010), cocoa plants can grow well and produce good quality cocoa beans in Indonesia. Following are the schemes for processing cocoa beans into cocoa powder and cocoa fat:

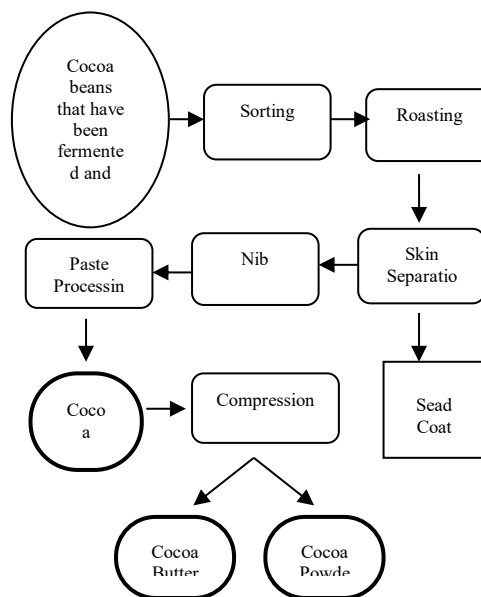

Picture 1. Stage of Cocoa Beans Processing (Hatmi, 2012)

Basically, the level of competitiveness of a country in the arena of international trade is determined by two factors, namely the comparative advantage factor and the competitive advantage factor.

Germany is one of the European countries that has the largest cocoa processing industry, but still imports cocoa products for their processing into chocolate and some are exported to other countries. According to data from ITPC Hamburg (2010), Germany is known as a consumer country of chocolate and cocoa products, with an average consumption per capita of 8-9 kg. USA is a country with high demand for cocoa seen from the level of consumption of the country towards cocoa-based products. The high level of

cocoa demand is also because USA is one of the countries that have the largest cocoa processing industry in the world. So that the demand for cocoa raw materials such as cocoa beans and semi-finished materials is needed in Germany and the USA to meet these manufacturing needs.

Indonesia as a cocoa producer country should aim at potential markets specifically for cocoa processed products such as cocoa paste, chocolate powder and chocolate fat in Germany and the USA. However, some of the problems faced are not yet known how much the competitiveness of these cocoa products in Germany and the USA.

This study aims to (1) Analyze the competitiveness of cocoa paste products, cocoa powder and cocoa butter in Germany and the USA. (2) Test the calculation results of the RCA index of cocoa paste, cocoa powder and cocoa butter in Germany and the USA.

RESEARCH METHOD

The type of data used for this study is secondary data. The data and information used are time series data between 2006 and 2015 from the United Nations Commodity Trade Statistics Database, coupled with data and information from various related sources including FAO, ICCO, Central Bureau of Statistics, Indonesian Ministry of Trade, Coffee Research Center and Indonesian cocoa and additional data from sharing literature.

The subject of this study is a database of comtrade.com which is a source of official international trade data for various commodities throughout the world published by the United Nations. The object of this research is information about the trade of Indonesian cocoa chocolate products on the international market, volume and prices in importing countries namely Germany and the USA. Germany and USA were chosen as importing countries in this study because Germany and the USA are one of the largest importing countries of cocoa products from Europe and America, have the largest cocoa processing industry in the world, cocoa international trade players have even become countries that influence cocoa internationally, besides that Germany and the USA for the past 10 years have always imported cocoa (butter, powder, paste) products from Indonesia.

RCA and RSCA approaches

The RCA (Revealed Comparative Advantage) approach is used to analyze the competitiveness of Indonesian cocoa products (cocoa paste, cocoa powder, and cocoa fat). If the calculation of the RCA index > 1, Indonesian cocoa products are competitive and if the RCA index < 1 then Indonesian cocoa products are not competitive. Mathematically RCA is formulated:

$$RCA = \frac{X_{ij}/X_j}{X_{iw}/X_w}$$

X_{ij} = export of product i (Indonesian cocoa) to Germany or USA

X_j = total commodity exports i (Indonesian cocoa) to Germany or USA

X_{iw} = export of commodity i (world cocoa) to Germany or USA

X_w = total commodity exports i (world cocoa) to Germany or USA

RSCA (Revealed Symmetric Comparative Advantage) is used to avoid upward-biased problems from the RCA index value. With RSCA we can make the RCA index symmetrical with interval values between -1 and +1 (Prasad, 2004). The RSCA value positively indicates that Indonesian cocoa products have a high comparative advantage in the German or USA market. Conversely, if the RSCA value is negative then Indonesian cocoa products do not compete in the German or USA markets because they do not have comparative and inefficient advantages. Here's the RSCA formula:

$$RSCA = \frac{(RCA - 1)}{(RCA + 1)}$$

RESULTS AND DISCUSSION

Since the enactment of the Minister of Finance Regulation Number 67 / PMK.011 / 2010 which imposes export fees for cocoa beans, cocoa businessmen have begun processing cocoa beans into semi-finished products. According to Syadullah (2012), there is a clear causal relationship between the implementation of BK policies and the increase in the domestic cocoa processing industry. Since the implementation of BK, the export of cocoa beans has decreased significantly. The number of cocoa processing industry companies increased from the original 5 companies to 16 companies in 2011.

Competitiveness in Germany

Table 1. Indonesian RCA Index to Germany (2006-2015)

Year	Butter	Pasta	Powder
2006	0.98	0.16	0.49
2007	0.50	1.91	0.28
2008	0.61	5.54	0.33
2009	0.47	5.68	0.39
2010	0.51	2.22	0.11
2011	1.58	8.84	0.07
2012	4.32	3.16	1.16
2013	3.65	2.82	3.63
2014	2.92	2.33	4.11
2015	3.69	1.86	0.84
Average	1.92	3.45	1.14

Source: Comtrade, 2016 (data processed)

Table 1. Shows data from 2006 - 2015 Indonesian cocoa butter products have competitiveness on the German market with an average RCA index of 1.92 and RSCA 0.51. Cocoa paste has competitiveness with an average RCA index of 3.45 and RSCA 0.38. The competitiveness of Indonesian cocoa powder in Germany shows the average RCA 1.14 and RSCA index -0.24 which means that for these products Indonesia does not yet have competitiveness.

Competitiveness in the USA

Table 2. Indonesian RCA and RSCA Index to USA (2006-2015)

Year	Butter	Pasta	Powder
2006	0.86	0.07	0.10
2007	1.29	0.21	0.31
2008	1.58	0.06	0.10
2009	1.06	0.11	0.08
2010	1.12	0.09	0.08
2011	4.05	0.01	0.09
2012	4.26	0.00	0.06
2013	4.40	0.00	0.04
2014	3.48	0.07	0.06
2015	3.67	0.34	0.04
Average	2.58	0.10	0.10

Source: Comtrade, 2016 (data processed)

Table 2. Shows the competitiveness of cocoa products in the USA in 2006 - 2015. Cocoa fat products (cocoa butter) have an average RSCA index of 0.33 so that Indonesian cocoa fat products have competitiveness in the USA market. as mentioned by Amelia *et.al.* (2015) that cocoa butter has the highest competitiveness than other cocoa derivatives products in USA markets. The average RSCA index for Indonesian cocoa paste products is -0.8 this shows that Indonesian cocoa paste does not yet have competitiveness in the USA market. Indonesian cocoa powder products have an average RSCA index of 0.83 indicating this product cannot compete in the USA market.

As shown in result above, to increase the overall competitiveness of Indonesian cocoa and its derivatives products, Indonesia needs maintaince the competitive products and increasing the less competitive products. Indonesia as cocoa producer country need to maintain its plantation area, the quality of seed, and to make sure the quality of cocoa beans along with characteristic of cocoa butter indirectly. Government rapid and continuous intervention such as pricing, contract negotiations, and trade relations also needed to support the downstream industry for cocoa paste and cocoa butter.

CONCLUSION

Based on the data analysis in this study, it can be concluded as follows:

1. In Germany, cocoa paste products and Indonesian cocoa butter have competitiveness, while cocoa powder does not have competitiveness.
2. In the USA, Indonesian cocoa butter has competitiveness, while cocoa paste and cocoa powder do not have competitiveness.

SUGGESTION

Based on the results of research and discussion, it is suggested as follows:

1. Consumption of cocoa processed products in Germany and the USA continues to increase every year so that raw material requirements also increase. There needs to be an increase in trade relations or contract negotiations with

Germany and the USA to increase the volume of Indonesian exports.

2. The government needs to provide guidance, training and business cooperation with plantation business actors and cocoa processing from upstream to downstream, the export subsidy policy can be done to motivate cocoa business operators to export.
3. Further research is needed on the flow of cocoa product exports from Indonesia abroad related to the dominance of multinational companies in Indonesia such as Cargill, Nestle, Cadbury Schweppes, Mayora, and others whether exports are carried out by foreign companies and occur due to material movements standard within the company.

BIBLIOGRAPHY

- Amelia, Rizky., Kusnadi, Nunung., and Suharno. 2015. *Indonesia's International Competitiveness of Cocoa Beans and Its Derivatives Product in USA Market*. International Journal of Science and Research (IJSR). ISSN: 2319-7064. Index Copernicus Value (2015): 78.96. Impact Factor (2015): 6.391.
- Becket, S.T, 1999. *Industrial Chocolate Manufacture and Use*. Blackwell Science Ltd, Oxford.
- Hatmi, R.U and S. Rustijarno, 2012. *Teknologi Pengolahan Biji Kakao Menuju SNI*. Balai Pengkajian Teknologi Pertanian. Yogyakarta.
- Hamdy, 2001. *Analisis Hyper Competitive*.
- Kotler Philip, Keller L. Kevin, 2006. *Metodologi Penelitian: Aplikasi Dalam Pemasaran*. Jakarta.
- Prasad, R. N., 2004. *Fiji's Export Competitiveness: A Comparison with Selected Small Island Developing States*. Economics Department, Reserve Bank of Fiji.
- Ragimun, 2012. *Analisis Daya Saing Komiditas Kakao Indonesia*. Pusat Kebijakan Ekonomi Makro Kebijakan Fiskal Kemenkeu. Jakarta.
- Syadullah, Makmun, 2012. *Dampak Kebijakan Bea Keluar Terhadap Ekspor dan Industri Pengolahan Kakao*. Badan Kebijakan Fiskal Kementerian Keuangan. Jakarta.
- Tambunan, 2001. *Korelasi Positif dengan Kinerja atau Tingkat Daya Saing Ekspor*.
- Widodo L, 2000. *Analisis Daya Saing Kakao dan Kakao Olahan Indonesia*. UI. Jakarta.
- Widodo, E. dan Mukhtar, 2000. *Konstruksi ke Arah Penelitian Deskriptif*. Aveyrous. Yogyakarta
- Wibowo, 2004. *Teori Globalisasi Makro Ekonomi Perdagangan Bebas Atau Pasar Bebas*.

Comparison of E-Commerce Transactions in Conventional Accounting and Sharia Accounting

Eko Sudarmanto
 University of Muhammadiyah Tangerang
 Indonesia
 ekosudarmanto.umt@gmail.com

Abstract— *Muamalah and business develop along with technological developments and human needs. When the business model and muamalah develop, this development must be responded to appropriately and carefully. Not only related to the aspects of benefits, harm and legal conditions that govern it, but also must be prepared and developed the model and accounting system needed. One form of the new trading business is e-commerce. Namely business activities involving consumers, manufacturers, providers, and brokers using computer networks, namely the internet. So that e-commerce transactions have several characteristics, including: unlimited transactions, anonym transactions, digital and non-digital products, and intangible goods. Based on several characteristics found in e-commerce transactions, the applicable law related to the transaction is the law regarding long-distance buying, salam and salaf law, hawalah law and electronic money. With the different viewpoints and legal basis for e-commerce transactions, the accounting treatment between conventional and Sharia systems also has several differences. Sharia Accounting Bai' as-Salam is a buying and selling accounting system that is most suitable for e-commerce transactions.*

Keywords— *muamalah, e-commerce, bai' as-salam*

I. INTRODUCTION

Aggressive competition marked by the emergence of new companies and technological advancements today makes business competition increasingly globalized. This competition makes companies get pressure to always survive in dynamically changing environmental conditions. The key to winning the competition is through innovation. No matter conventional companies or economic business units that are managed and operated based on the Islamic economic system.

The survival of the economic unit depends on how quickly and responsively the economic unit is facing the changes. So that technology and innovation are important factors in increasing the profit, positioning and performance of business units in the face of market changes. By innovating, economic units react to market changes that are always dynamic and create or maintain their competitiveness. Can be said that "innovation is an almost obligatory survival strategy" (Drucker, 1985). Economic units that succeed in creating competitive advantage are economic units that are able to create innovation and creativity through an effective and planned innovation

process. Therefore, new ways or strategies are needed in creating and producing new products or making improvements by increasing the ability of new ways of providing services to customers or customers.

Globalization and technology are the two most significant drivers of business performance. With globalization and technology will increase profits from economies of scale and scope by utilizing global technology, as well as for economic units that want to operate globally. Almost every economic unit in the business world that is related to buying and selling transactions requires technology that has a very important role as a media link between producers and consumers. With this technology, marketing, sales and purchasing activities can be carried out through electronic systems with internet media.

The presence of modern computers and information technology has created vast opportunities for managers and organizations to use their resources. With more than 500 million users worldwide and increasing exponentially, the internet and all global subnetworks have become one of the most dominant enablers for better, faster and cheaper business operations. Distance and time are no longer a problem.

On the other hand, Islam as a perfect religion and in accordance with human nature, certainly has a perfect and perfect life concept. It not only regulates human relations with God, but also regulates human relations known as muamalah. Even according to research conducted by Jalaluddin Rahmat, Islam is a religion that emphasizes the business of muamalah is greater than the matter of ritual worship. Islam turns out to pay much attention to aspects of social life rather than aspects of ritual life.

Although muamalah and business continue to change and develop along with the development of technology and human needs, in Islam there is no unregulated case but all there are boundaries of the Shari'a that govern it. Included in the economic field, especially e-commerce transactions, how Islam responds and regulates these contemporary transactions. And what are the similarities or differences in conventional accounting with Islamic accounting for e-commerce transactions.

II. LITERATURE REVIEW

A. Definition of E-Commerce

The term E-Commerce is short for Electronic Commerce. E-commerce is part of Electronic Business. In general, e-commerce can be defined as all forms of trade transactions of goods or services using electronic media.

The choice of the internet as an electronic media is chosen because of the convenience that this electronic network has:

- 1- The internet as a very large public network, as befits an electronic public network, which is cheap, fast, and easily accessible.
- Using electronic data as a medium for delivering messages or data, so that information can be sent and received easily and concisely, both in the form of analog and digital electronic data.

While Onno W Purbo and Aang Wahyudi, citing David Baum's opinion, stated that e-commerce is a dynamic technological device, application and business process that connects companies, consumers and communities through electronic transactions and trade in goods, services and information carried out.

So e-commerce is business activities that involve consumers, manufactures, service providers and brokers using computer networks, namely the internet. Or it can be said that e-commerce is a business transaction between a company and another company, between a company and a customer, or between a company and an institution engaged in public service.

If classified, e-commerce systems are divided into three types of applications, namely:

1. Electronic Markets (EMs): EMs are a facility that uses information and communication technology to bid in a market segment, so that buyers can compare the various types of prices offered.
2. Electronic Data Interchange (EDI): EDI is a means to streamline the exchange of large numbers of recurring regular transactions between commercial organizations.
3. Internet Commerce: Internet Commerce is the use of internet-based information and communication technology for trade.

While the scope of E-Commerce practices includes:

- Electronic Business: is the scope of electronic trading activities in a broad sense.
- Electronic Commerce: is the scope of trade carried out electronically, which includes:
 - Trade via the Internet (Internet Commerce);
 - Trade with internet Web facilities (Web Commerce);
 - Trade with an electronic data interchange / EDI system.

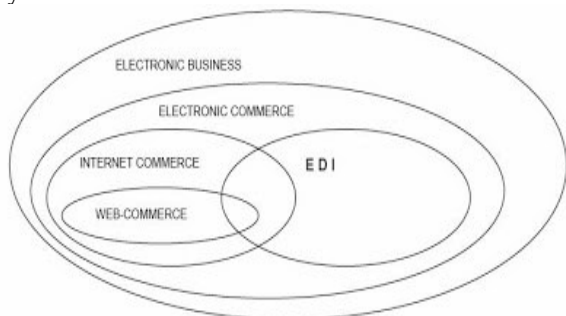

The scope of e-commerce

In summary, e-commerce is expected to be able to handle the following

problems:

- 1- Automation: an automation process that replaces manual processes.
- 2- Integration: an integrated process that will improve the efficiency and effectiveness of the process.
- 3- Publication: providing promotional and communication services for marketed products and services.
- 4- Interaction: exchange of data or information between various parties that will minimize "human error".
- 5- Transaction: an agreement between two parties to conduct transactions involving other institutions as the party handling payments.

B. Characteristics of E-Commerce

E-commerce transactions have some special characteristics, namely:

- Unlimited transactions: Today with the internet anyone can market their products internationally simply by creating a website or by placing advertisements on internet sites indefinitely (24 hours), and of course customers from all over the world can access the site and do transactions online.
- Anonymous transactions: Sellers and buyers in transactions over the internet do not have to meet each other.
- Digital and non-digital products: Products that are digital can be marketed via the internet by downloading them electronically, including daily necessities.
- Product intangible goods: Many companies engaged in e-commerce by offering intangible items such as data, software and ideas sold through the internet.

C. E-Commerce Mechanism

On-line contracts in e-commerce according to Santiago Cavanillas and A. Martines Nadal, as quoted by Arsyad Sanusi have many types and variations, namely: Contracts through Chat and video conferencing; contract by e-mail; Contract through the web or site.

Next, the mechanism is as follows:

- 1- For online products in the form of software, buyers are allowed to download them;
- 2- For products that are physically tangible, the delivery of goods is carried out to the customer's home;
- 3- For the purchase of services, suppliers provide to serve consumers according to the time and place that has been determined in accordance with the agreement.

For e-commerce payments, many alternatives are offered to buyers, including using credit cards, debit cards and e-cash..

III. METHODOLOGY

The methodology used in this research is through library research, which does not use quantitative analysis with statistics, but through a qualitative approach, namely research that emphasizes the analysis of processes from deductive and inductive thinking processes related to the dynamics of the relationship between observed phenomena, and always uses scientific logic. The data source used is a variety of qualitative data that maintains its quality and takes the form of words or sentences derived from various sources of books and scientific works.

This research was conducted with a comparative method, namely research conducted to compare a variable object of research, between different subjects or different times.

The data source of this research is secondary data sources consisting of previous relevant scientific research works, in the form of scientific books that discuss e-commerce transactions in various perspectives.

Data processing is done by: (i) analyzing by paying attention to the correlation or relationship between various data sources that are relevant to the context of the research. (ii) compare and analyze the differences in e-commerce transactions in conventional accounting and Islamic accounting. (iii) Conclude according to the existing theoretical framework for the research that have been conducted.

IV. RESULTS AND ANALYSIS

A. RESULTS

Based on this description, trade transactions through e-commerce can be described as follows:

- 1- The seller and buyer are not in the same place, can be in different cities, regions or countries;
- 2- The goods traded in e-commerce transactions do not exist in one place, where the seller and buyer meet. The item is only an image, photo or film that is shown to the buyer before the transaction takes place;
- 3- Payment is made by the buyer in front in cash, then the item will be sent by the seller to the buyer;
- 4- The payment instrument used is money transferred through a credit card, debit card or smartcard.

Based on the facts above, it can be concluded that the applicable law relating to e-commerce transactions is the law of long-distance buying, salam, and hawalah.

a- Islamic Law concerning Long-distance Trade

In a simple sense, bai 'as-salam means the purchase of goods delivered later, while payments are made in advance.

Long-distance trade is the exchange of assets with assets in the form of transfer of ownership, where the presence of sellers and buyers is in two different places. As in the general terms of sale and purchase, Shari'a has made liking factors like as a basic requirement for sale and purchase contracts. Although sellers and buyers are in two different places.

Therefore, the place does not prevent the occurrence of *ijab* and *qabul*. The meeting between the *ijab* and *qabul* in the assembly of long-distance sale agreements, both by

telephone, fax, telex, internet, and so on, basically has the same law as buying and selling in the same place.

Al-Kasani said, that *ijab* and *qobul* are by message, even though the seller and buyer are not in one place, then buying and selling like that is legal.

b- The law of buying and selling as-salam

Sale and purchase of Salam is the sale and purchase of goods described in the responsibility. Salam are also a form of buying and selling by surrendering current payments for compensation described as being in a certain tempo. Imam an-Nawawi explained that salam is an agreement on something described in the responsibility with immediate compensation. Called salam, because the surrender of prices occurs in the contract assembly, and the price is paid in advance.

Salam is legal (masru ') based on the word of Allah SWT in the Quran surah al-Baqarah [2]: 275.

Buying and selling in the verse also includes salam, because salam is a form of buying and selling. The legality of salam is also indicated by the word of Allah SWT in surah al-Baqarah [2]: 282.

The hadith is narrated by Ibn Majah, "He who does the salam, he should do with a clear measure and a clear scale for a known period of time."

Based on the description and legal basis of the sale of Salam, it can be concluded that e-commerce or e-business is a fact of Salam buying and selling, ie the seller and buyer meet in a contract assembly, because of the long distance factor, goods offered to buyers cannot be handed over directly. In other words, the goods that are intended to be sold through the internet are those described (*dhimmah maushufah*) in the hands of the seller. Because what is shown to the buyer is the image or film of the item. In addition, the payment terms at the front of every buying and selling transaction through e-commerce are the conditions that apply in the sale of salam.

c- Law of Hawalah

According to Ibn Rushd, hawalah is a form of legal transaction, and is exempt from the practice of repaying debt with debt. The law of hawalah is basically *mubah*. It's not going to happen, when *muhil* doesn't have the rights that exist in the *muhtal*, which can be transferred to third parties (*muhal'alaihi*). Therefore, Ibn Qudamah, states that hawalah is the same as *taslim* (surrender of rights / dependents). In practice, hawalah is not only in the form of debit from certain bank card users' funds, but it can also be in the form of transfers and remittances. This can also be categorized as hawalah practice.

d- Accounting for E-Commerce Transactions

Accounting is defined as a collection of procedures for recording, classifying, summarizing and reporting in the form of financial statements, transactions that have been carried out by the company, and interpreting. Whereas sharia accounting is accounting that is applied in sharia-based institutions to ensure the creation of economic justice through the formalization of procedures, activities, measurement of objectives, control and reporting in accordance with sharia principles.

. To record sales and purchases of merchandise, there are sales journals and purchase journals. The sales journal is a journal that is used to record all the selling points of merchandise made on credit. Whereas the purchasing journal is a journal used to record all merchandise purchases made on credit.

For more details, the following two examples illustrate e-commerce transactions:

First illustration:

On July 1, 2019 Mr. A bought online (via: Online Shopping Application) in the form of a pair of shoes with certain specifications to Mr. B in another city. For the transaction through the online shopping application Mr. A was asked to transfer through Bank X for IDR 100,000, plus the shipping fee of IDR 10,000, - Mr. B after getting a notification of the goods order from the online shopping application, immediately prepare and send the order. Dated July 5, 2019 Mr. A has received the order according to the specifications. Then Mr. B immediately gets a payment through a virtual bank account of IDR 110,000,-

The journal for the transaction in accordance with PSAK is:

Date	Subject	Transaction	Conventional Acc. (IDR)	Sharia Acc. (IDR)
July 01, 2019	Buyer	D: Purchase receivables – OL D: Cost of shipping K: Cash	(D) 100.000,- (D) 10.000,- (K) 110.000,-	(D) 100.000,- (D) 10.000,- (K) 110.000,-
July 01, 2019	Bank X	D: Cash K: Deposit (<i>wadiah</i>) 1 - Virtual Account	(D) 110.000,- (K) 110.000,-	(D) 110.000,- (K) 110.000,-
July 01, 2019	Seller	D: Receivable – Sales OL K: Inventory - Shoes K: Cash	(D) 110.000,- (K) 100.000,- (K) 10.000,-	(D) 110.000,- (K) 100.000,- (K) 10.000,-
July 05, 2019	Buyer	D: Inventory – Shoes K: Purchase receivables – OL	(D) 100.000,- (K) 100.000,-	(D) 100.000,- (K) 100.000,-
July 05, 2019	Bank X	D: Deposit (<i>wadiah</i>) – Virtual Account K: Virtual Account – OL	(D) 110.000,- (K) 110.000,-	(D) 110.000,- (K) 110.000,-
July 05, 2019	Seller	D: Virtual Account - Bank X K: Receivable – Sales OL	(D) 110.000,- (K) 110.000,-	(D) 110.000,- (K) 110.000,-

Second illustration:

A leather jacket entrepreneur requires funds of USD 200,000 to order 200 pieces of jacket products. He submitted a request for funds to the Islamic bank for this purpose. After being analyzed and declared eligible for a loan, on July 2, 2019 the bank made a salam agreement with the entrepreneur. The way the bank will buy a jacket with certain specifications as much as 200 pieces at a price of USD 200,000. Because the bank does not need a leather jacket for its own needs, after the leather jacket has been produced on July 12, 2019, the bank can sell it to other parties or ask employers to find buyers at a higher price, for example USD

1,100 per piece. Thus the bank gets a profit of USD 20,000 (USD 100 x 200).

Date	Subject	Transaction	Conventional Acc. (USD)	Sharia Acc. (USD)
July 02, 2019	Entrepreneur	D: Cash / Saving K: Debt - <i>Salam</i>	- -	(D) 200.000 (K) 200.000
July 02, 2019	Sharia Bank	D: Inventory – <i>Salam</i> K: Cash	- -	(D) 200.000 (K) 200.000
July 12, 2019	Entrepreneur	D: Debt – <i>Salam</i> D: Cost of <i>Salam</i> K: Cash	- - -	(D) 200.000 (D) 20.000 (K) 220.000
July 12, 2019	Sharia Bank	D: Cash K: Inventory – <i>Salam</i> K: Benefit of <i>Salam</i>	- - -	(D) 220.000 (K) 200.000 (K) 20.000

From the explanation and the two illustrations of the transaction, it can be understood that between conventional accounting and Islamic accounting in the transaction treatment is relatively the same, both in the technical acceptance of money, payment or transfer, used computer technology, and financial statements. What distinguishes the two is in terms of products and procedures for producing them. Where not all products in a conventional industry can be accepted in the Islamic system, including the procedure for producing a product. If the procedure or production process is not in accordance with sharia rules, of course the results of such production cannot be accepted because they are not in accordance with sharia principles.

B. Conclusions and Recommendations

□ Conclusions

Based on the discussion of this paper, it can be concluded that e-commerce transactions are:

The survival of the economic unit depends on how quickly and responsively the economic unit is facing the changes. Technology and innovation are important factors in increasing the profitability, positioning and performance of business units in the face of market changes. While globalization and technology are the two most significant drivers of business performance.

E-commerce transactions are all forms of trade transactions of goods or services using electronic media. E-commerce transactions are also defined as business transactions between a company and another company, between a company and a customer, or between a company and an institution engaged in public service. With e-commerce transactions, it is expected to be able to overcome several problems: automation, integration, publication, and interaction.

The applicable law related to e-commerce transactions is the law of long-distance buying and selling, salam, and hawalah. Long distance buying and selling is the exchange of assets with assets in the form of transfer of ownership, where the presence of sellers and buyers is in two different places. Salam is a form of sale and purchase by surrendering

1 *Al-Wadi'ah* is a deposit from one party to another, both an individual and a legal entity, which must be guarded and returned at any time if the requester wishes. (Anggadini, Sri Dewi and Komala, Adeh Ratna, 2017).

current payments for compensation described in a certain period of time. While hawalah is not only in the form of debit from certain bank card user funds, but also can be in the form of transfers and remittances.

Conventional accounting and sharia accounting in practice are relatively the same. What distinguishes the two is in terms of products and production processes. Where not all products and production processes in a conventional industry can be accepted in the sharia system. If the production process of a product is not in accordance with the rules of sharia, the product it produces is also categorized as non-halal products, and Islamic banks cannot provide services to non-expensive products or whose halal status is still in doubt.

□ Recommendations

Sharia-based economics and accounting should be able to be introduced and developed, especially in Islamic campuses as the most appropriate means to develop and develop a sharia-based economy which currently continues to grow.

The government should bridge and encourage the development of sharia-based financial institutions, with various policies and provide greater opportunities for the participation of Islamic financial institutions in national-scale economic development.

REFERENCES

- [1] Al-Qur'an and translation
- [2] Abdurrahman, Hafidz and Abdurrahman, Yahya. (2015). *Bisnis dan Muamalah Kontemporer*. Al-Azhar Freshzone Publishing, Bogor.
- [3] Al-Kasani. (no year). *Badar ash-shanar*, Juz V.
- [4] An-Nawawi. (no year). *Al-Majmu Syarh al-Muhadzdzab*. Juz IX.
- [5] Anggadini, Sri Dewi and Komala, Adeh Ratna. (2017). *Akuntansi Syariah*. Rekayasa Sains, Bandung.
- [6] Dewanto, Wawan Dkk. (2014). *Manajemen Inovasi*. Andi, Yogyakarta.
- [7] Drucker, P.F. (1985). *Innovation and Entrepreneurship*. New York: Harpercollins Publisher.
- [8] Gupta A. and J. MacDaniel. (2002). *Creating Competitive Advantage by Effectively Managing Knowledge: A Framework for Knowledge Management*, *Journal of Knowledge Management Practice* Vol. 3.
- [9] Ikatan Akuntan Indonesia, (2018). *Standar Akuntansi Keuangan - PSAK 23*, IAI Jakarta.
- [10] Kisworo, Marsudi W. and Sofana, Iwan. (2017). *Menulis Karya Ilmiah*. Informatika, Bandung.
- [11] N Lapoliwa and Kuswandi, Daniel S. (2000). *Akuntansi Perbankan*. Instiut Bankir Indonesia, Jakarta.
- [12] Qudamah, Ibnu. (2006). *Al-Mughni, Dar al-Afkar ad-Duwaliyyah*, Yordania. Juz I.
- [13] Rahmat, Jalaluddin. (1991). *Islam Alternatif*. Mizan, Bandung. Cet. IV.
- [14] Sumarsan, Thomas. (2013). *Akuntansi Dasar dan Aplikasi Dalam Bisnis*. Indeks Jakarta.

The Effect of Audit Quality, Tax Planning and Leverage on Earnings Management

Agustine Dwianika¹
Accounting Department
Universitas Pembangunan Jaya
Tangerang, Indonesia
agustine.dwianika@upj.ac.id

Sila Ninin Wisnantiasri²
Accounting Department
Universitas Pembangunan Jaya
Tangerang, Indonesia
sila.wisnantiasri@upj.ac.id

Abstract — *This study is to address a current issues about how important of audit quality for supporting firm's performance, due still there a research gap from previous literatures about the effects of audit quality on earnings management. This paper aims to illustrate and examine the effect of audit quality on the relationship of tax planning rates and leverage on earnings management, based on evidence in Indonesia. This quantitative study using secondary data obtained from the company's annual report. The research population is LQ-45 firms listed on the Indonesia Stock Exchange in 2013-2017 as many as 45 companies. The data analysis technique used was multiple linear regression analysis using SPSS 22 for Windows. The results of this study indicate that tax planning and leverage affect earnings management. While audit quality as a moderating variable strengthens the relationship between tax planning and leverage on earnings management. This study provides futher evidence of earnings management related about audit quality, tax planning and leverage separately for academically side. For practitioners, it can be used as a consideration in making investment decisions, that there is a connection between the things that become variables in this study. Keywords— Audit Quality, Tax Planning, Leverage and Earnings Management*

Introduction

The company always strives to maximize the achievement of the best performance in order to maintain its existence in business competition. Maintaining stakeholder trust is important, because companies that have gained trust from stakeholders will have the opportunity to gain success and survive in business competition (Susanto, 2017) [1]. Presentation of financial statements is the final product of financial accounting, where an important aspect in financial accounting is an assessment / measurement (valuation / measurement) through a balance sheet approach or income statement (Sunarto, 2009) [2].

Accounting information can be relevant, if it can meet the needs of all parties who use it. Not only internal parties, but external parties who have interests also need information in financial statements. This difference in interests causes differences in information needed between one party and another (Sulistiyanto, 2008) [3]. Many companies in managing company finances practice earnings management to cover the lack of financial statements in a certain period in order to look more attractive to users of financial statements (Anhara, 2015) [4]. According to Sari & Ahmar (2014) [5] profit is a component derived from the

difference between income and expenses. Therefore, income and expenses can be used as management targets for managing earnings. Various types of earnings management detection models can be used to measure earnings management in a company.

Some studies on earnings management are mostly associated with company performance by comparing how the company performs before and after offering shares due to earnings management activities (Barus & Sembiring, 2012) [6]. In general, earnings management can be done because the basis of recording transactions is accrual, where the recording of these transactions without having to be accompanied by cash receipts or disbursements. The manager's attitude can be the embodiment of earnings management, especially to intervene in financial statement information by utilizing freedom in choosing and using accounting methods, where managerial engineering activities are difficult to detect. Financial statement users will find it difficult to find out whether the information on the financial statements has been engineered or not just by reading the financial statements (Sulistiyanto, 2008) [3].

An example case about manipulation of financial statements by PT. Timah (TINS) in 2015. PT Timah

(Persero) Tbk allegedly provided fictitious financial reports in the first semester of 2015. This fictitious financial report activity was carried out to cover PT Timah's financial performance, which continued to worry. Chairman of the Tin Employee Association (IKT), Ali Samsuri revealed that PT Timah's financial condition had not been healthy for the past three years. The inability of the PT Timah Board of Directors to come out of the loss trap has resulted in the surrender of 80% of PT Timah's mining area to business partners. The surrender of PT Timah's mining area to business partners has negative consequences for PT Timah's future, especially for 7,000 employees in this state-owned company. Previously, the Board of Directors had also decided to close the operations of the large mining area owned by PT Timah, namely in TB Mapur, TB Nudur and TB Tempilang which were then handed over to business partners. If referring to the real conditions that occur at PT Timah (Persero) Tbk's fictitious financial statements for the first semester of 2015, PT Timah. Because in the first semester of 2015 PT Timah's operating profit suffered a loss of Rp. 59 billion. So the financial report that states that PT Timah has succeeded in carrying out efficiency activities and the right strategy and positive performance is a big lie (Eginus, 2016) [7].

On other hand, PT Timah also recorded an increase in debt of almost 100 percent compared to 2013. In 2013, the company's debt only reached Rp263 billion. However, the amount of this debt increased to IDR 2.3 trillion in 2015

(Arfianto, 2016) [8]. An investment decision making requires information about the income received by the institution, which is often the target of opportunistic engineering to maximize the interests of management, so that it can endanger investors (Christiani & Nugrahanti, 2014) [9]. The tendency of stakeholders to pay attention about earnings reports that can motivate managers to plan certain strategies, so that the reports produced are in accordance with the stakeholder's expectations, which is to do earnings management (Susanto, 2017). The problem starts when earnings management carries a negative influence and tends to mis-lead information users in their financial reporting (Prasetya & Gayatri, 2016) [10]. This action covers the selection of accounting policies where management can regulate the rise, fall or even the average profit that the company produces, this behavior is known as earnings management (Sari & Asturi, 2015) [11].

Yunita & Darmawati (2013) [12] states that management conduct earnings management usually for various purposes such as avoiding political costs, avoiding violations of debt agreements, in an effort to influence capital market decisions and also to get bonuses and other compensation. Earnings management practices can influence the relevance of financial statement presentation, this is because the financial statements presented are not helpful, but mislead the users. The actual state of a company is often associated with earnings management behavior, because earnings management is considered not always displaying the actual situation and the action is based on various reasons, including to meet the interests of company owners by increasing the value of the company so that corporate uncertainty is low (Putra, 2009) [13]; (Maulana, 2014) [14].

Earnings management practices are closely related to agency theory, namely the existence of differences in interests between management and owners of companies and the government. Earnings management practices are also influenced by several factors such as tax planning, namely the process of controlling actions to avoid the consequences of unwanted taxes, and controlling the amount of tax paid by tax avoidance and not tax smuggling (Wardani and Santi, 2018); Zain (2003) [15]. According to Djoko Muljono (2009) [33] tax planning is one of the company's planning activities related to business activities carried out by entrepreneurs to be able to carry out obligations and get rights related to taxation, which will have an adverse effect on employers.

Sulistiyanto (2008) [3] stated that managers tend to try to minimize their obligations, among them the obligation to pay taxes. For managers, the smaller the tax must be paid to the government, the smaller the obligation. There are various ways that managers can do to manage profits to reduce the value of corporate taxes, for example, companies make inventory purchases at the end of the year to reduce their taxes. In normal economic conditions which tend to rise, companies that use the LIFO inventory assumption will generate high principal selling prices. Conceptually, if the basic price is higher, it will reduce the company's profit. As a result, the taxes paid to the government will be lower.

Earnings management is also closely related to leverage, when viewed from agency theory, leverage can be used as an additional oversight mechanism for management that can reduce agency costs incurred by shareholders (Utami

& Meiranto, 2017) [16]. The higher the leverage, the higher the company's dependence on debtholder so that the desire to avoid violating the debt contract will also be higher. Leverage is the level of securities with debt used in a company's capital structure, leverage is the ratio used to measure the extent to which a company is financed by debt. Debt can have good or bad influence for the company, this phenomenon is evidenced by the fact that on the one hand, companies must be able to generate profits to be able to cover their obligations to shareholders and to avoid making loans to external parties for the survival of the company (Sambora, Handayani, & Rahayu, 2014) [17]. In companies that have a high debt to equity ratio, company managers tend to use accounting methods that can increase income or profits (Ramadhan, 2017) [18].

This results in financial reports being unreliable because the information contained in them is biased, does not display actual information, for which a quality audit is able to limit earnings management practices so that financial reports can be accounted for. Auditing financial statements carried out by the auditor has different qualities, therefore, high-quality auditing will act as a deterrent to effective earnings management, because the reputation of management will be destroyed and the value of the company will drop if reporting this wrong is detected and revealed (Amijaya & Prastiwi, 2013) [19]. Audit quality can be interpreted as all possibilities that can occur when the auditor audits the client's financial statements and finds violations or errors that occur and reports them in the audited financial statements (Dewi & Jati, 2014) [20].

With management actions in managing earnings, an independent party is needed to mitigate the existence of information asymmetry so that it reflects that the company's performance is far better.

Auditors are expected to be able to mitigate the actions of the company's management in managing revenue, can minimize information asymmetry and detect financial statement discrepancies (findings), and their opinions can be used as a reference for investors as investment considerations or vice versa, so that they are more confident investing in companies with reasonable audit opinions without exception (Herianti and Marunda, 2015) [21]; (Yunita and Darmawati, 2013) [12]. However, with high audit quality, financial statements will be more relevant and credible, so that the risk of misstatement can be avoided which can also have an impact on the payment of obligations (Nihlati and Meiranto, 2014) [22]; (Dwianika, Amin and Setiyadi, 2018). It is encouraging researchers to conduct further studies.

Annisa and Lulus (2012) stated that the financial statements audited by the Big Four are suspected to be of higher quality with a lower level of fraud, when compared to companies audited by non-Big Four. The principal is considered to be more trustworthy in the report of the big name auditor with high integrity and independence possessed by the big auditor. But with the increase in KAP, the agent will try to minimize earnings management on an accrual basis, but it will increasingly improve its earnings management in real terms (Nihlati & Meiranto, 2014) [22].

The results of this study are expected to contribute both academically and practically. Academically it can be used as reference literacy for further research related to

earnings management practices. For practitioners, it can be used as a consideration in making investment decisions, that can be learned whether or not there is a connection between audit quality, tax planning, corporate debt in earnings management practices, so that it is expected to get sufficient information to decide which investment choices are appropriate.

Literature Review and Hypothesis Formulation

Agency Theory

The company is the center of contractual agreements between various parties, each of which has different interests, namely shareholders, management represented by managers, suppliers and other parties including potential investors and employees. The theory that explains the relationship between these parties (principal and agent) is called agency theory. The underlying problem of agency theory is the conflict of interest between owners and managers in the company. Managers, called agents and owners, called principals, are two parties who each have different goals in controlling a company, especially regarding how to maximize satisfaction and importance of the results achieved through business activities (Anhara, 2015) [4].

This theory can explain about the asymmetry information which is a condition of imbalance in information acquisition between management and shareholders (Christiani & Nugrahanti, 2014) [9]. Agency theory explains the relationship between the agent and the principal. Agents are company management, while the principal is the owner (shareholder). Agency theory describes the separation of company property rights and responsibility for decision making (Jasen & Meckling, 1976) [23]. Agency relations always cause problems between owners and agents because of differences in mindset and prominent differences in interests (Jasen & Meckling, 1976) [23].

Stakeholder Theory

The existence of a company is strongly influenced by the support given by stakeholders to the company, the company is not an entity that only operates for its own interests but must provide benefits to its stakeholders (shareholders, creditors, consumers, suppliers, government, society, analysts and other parties) (Chariri : 2008) [24]. Stakeholder support can affect the survival of the company. Companies must seek support by carrying out activities that show attention to the interests of stakeholders, so that disclosure of social responsibility is considered a powerful way to get support from stakeholders (Gargauri & Ridha Shabau, 2010) [25].

The stakeholder theory considers the impact of company disclosure policies when there are differences in stakeholder groups within a company. Disclosure of information by companies is used as a management tool to manage information needs needed by various groups (stakeholders), therefore management discloses information on social and environmental responsibility in order to manage stakeholders so that companies get support from them. This support can affect the survival of the company (Anhara, 2015) [4].

Profit in Earnings management according to Scott (2011) [26] is "The choice by managers of accounting policies so as to achieve some specific objective". This means that

earnings management is a decision of managers to choose certain accounting policies that are considered able to achieve the desired goals, both to increase profits or reduce the level of reported losses. Earnings management (earnings management) in a narrow definition only relates to the selection of accounting methods. Earnings management in a narrow sense can be defined as management behavior to "play" with the discretionary accruals component in determining the amount of earnings. Whereas in broad definition, earnings management is an act of managers to increase or reduce reported earnings at this time on a unit where managers will be responsible, without causing an increase or decrease in the long-term economic profitability of the unit (Zumrotun, 2013) [27].

Healy (1985) states that there are two approaches that can be used to detect management behavior in managing earnings. First, controlling the type of accruals, where accruals are broadly defined as the portion of revenue and expenses items in the income statement that are not represented by cash flows; and second, changes in accounting policies. Furthermore, Healy (1999) [28] states that discretionary accruals are used as a total accrual proxy. The assumption used is a relatively small non-discretion accrual to discretionary accruals, so that high total accruals contain high discretionary accruals. Accrual totals can be calculated in two ways. First, calculate changes in each balance sheet account that is the subject of accruals; and second, calculating the difference between net income and cash flow.

Scott (2009) [29] suggests several motivations for earnings management:

- a. **Bonus Purpose**, managers who have information on net income will act opportunistically to make earnings management by maximizing current profits.
- b. **Political Motivation**, Earnings management is used to reduce reported earnings due to public pressure which has resulted in the government setting stricter regulations.
- c. **Motivation Taxation**, Tax saving motivation is the most obvious motivation for earnings management. Various accounting methods are used with the aim of saving income tax.
- d. **CEO (Chief Executive Officer) Substitution**, CEOs who are approaching retirement will tend to increase income to increase their bonuses. If the company's performance is bad, it will maximize revenue so that it is not terminated.
- e. **Initial Public Offering (IPO)**, Companies that will go public do not have market value, and cause managers of companies that will go public to do earnings management in their prospectus in the hope of increasing the company's stock price.
- f. **The Importance of Providing Information**, Information about company performance must be conveyed to investors so that earnings reporting needs to be presented so that investors continue to assess that the company is in good performance.

Whereas according to Watts and Zimmerman (1986) [30] there are three hypotheses to motivate earnings management as bellow:

- a. **Bonus Plan Hypothesis**, a plan of bonus or managerial compensation will tend to choose and use accounting methods that will make the reported profits higher. This concept addresses that the bonus promised by the owner to the

company manager not only motivates the manager to work better but also motivates the manager to carry out managerial fraud. Managers will play with the size of the accounting numbers in the financial statements so that the bonus will be earned every year. This results in the company owner experiencing a double loss of obtaining false information and issuing a bonus for something that is not appropriate.

b. Debt (equity) hypothesis, a company that have a larger debt ratio will tend to use accounting methods with earnings reports that tend to be higher and tend to violate the debt agreement if there are certain benefits and benefits obtained. The profit is in the form of profit games so that debt obligations can be postponed for a period the next so that all parties who want to know the condition of the company that actually gets the wrong information and makes business decisions is also wrong.

c. Political Cost Hypothesis, a company tend to choose and use accounting methods that can reduce or increase the reported profits. This concept discusses that company managers tend to violate government regulations. Managers will play with profits so that the payment obligations are not too high so that profit allocation is in accordance with the wishes of the company.

There are various types of earnings management detection models can be used to measure earnings management in a company (Sari & Ahmar, 2014) [5]. Jones model is the first earnings management detection model introduced by Jones (1991) [31] which was later developed by Dechow et al. (1995) known as the modified Jones model. According to Stubben (2010) [32], there are several weaknesses of the modified Jones model model revealed as a cross-sectional estimation which indirectly assumes that companies in the same industry produce the same accrual process.

In addition, the accrual model also does not provide information for the component of managing corporate earnings where the accrual model does not distinguish discretionary increases in earnings through income or expense components. Seeing the weaknesses of research on earnings management, Stubben (2010) [32] developed a model that uses the main component of income, namely accounts receivable to predict earnings management. The use of revenue models in detecting earnings management can be applied to companies in Indonesia, but not many studies have used this model because it is a new model that can be used to detect earnings management.

The Revenue Discretionary Model was introduced by Stubben (2010) [32] on the basis of dissatisfaction with the accrual model commonly used today. There are two formulas in the revenue discretionary model that are used as measurements of earnings management. First is revenue model, this model focuses on income that has a direct relationship with accounts receivable. Second, the conditional revenue model, this model was redeveloped with the addition of company size (size), company age (age), and gross margin (GRM) which can be used to detect accrual earnings management regarding the provision of loans related to accounts receivable. Firm size is a proxy of financial strength. Company age is a proxy for the company stage in the business cycle. As a proxy for operational performance from a

comparison of companies with competitor companies, gross margins are used.

Tax Planning

Tax planning is one way that can be utilized by taxpayers in conducting tax management of their business or income, but it should be noted that the intended tax planning is tax planning without conducting a constitutional or taxation law that applies (Muljono, 2009) [33]. Tax planning (tax planning) is part of tax management and is the first step in conducting tax management (Aditama & Purwaningsih, 2014) [1].

According to Suandy (2011) [34] tax planning is the first step in tax management by collecting and researching tax regulations so that the types of tax-saving measures to be selected can be selected. The purpose of tax planning is to get around so that the tax burden can be reduced as low as possible by utilizing existing regulations to maximize income after tax, because taxes are an element of sharing to shareholders and to be reinvested.

According to Zain (2008) there are several general strategies for tax planning, namely as follows:

1. Tax Saving, is an effort to efficiency the tax burden through the selection of alternative tax imposition at a lower rate. For example, companies that have taxable income of more than Rp. 100 million can make changes in natural gifts to employees as benefits in the form of money.
2. Tax Avoidance, is an effort to efficiency the tax burden by avoiding taxation through transactions that are not taxable objects. For example, companies that are still experiencing losses, need to change employee benefits in the form of money into natural gifts because nature is not an object of tax Article 21 income tax.
3. Avoid violations of tax regulations, by mastering the applicable tax regulations, companies can avoid tax penalties in the form of:
 - a. Administrative sanctions: fines, interest or increase;
 - b. Criminal sanctions: criminal or confinement
4. Delaying payment of tax obligations without violating applicable regulations can be done through a delay in VAT payments. This delay is carried out by delaying the issuance of output tax invoices to the allowable deadline, especially for credit sales. In this case, the seller can issue a tax invoice at the end of the following month after the month of delivery of the goods.
5. Optimizing permissible tax credits. Taxpayers often lack information about paying taxes that can be credited which are prepaid taxes. For example, Article 22 Income Tax for the purchase of diesel and / or import and Fiscal Foreign Affairs for official travel of employees.

Leverage

According to Van Horne et al (2007) [35], leverage is the use of fixed costs in an effort to increase profitability. Leverage is a tool to measure how much a company depends on creditors in financing company assets, where the level of leverage of each company will vary (Roskha, 2017) [36]. The

lower this ratio, the higher the level of corporate funding provided by shareholders. Every company has a different debt policy and debt level. Company leverage can be influenced by various factors. These factors can be in the form of size, source of income, level of guarantee, cost of debt, opportunities for growth, reputation, and liquidity (Yuliana & Yuyetta, 2017).

The consequences of leverage according to Weston and Copeland (1997) if the use of debt turns out that the return on assets is greater than the cost of debt, leverage is profitable and returns on capital with the use of leverage also increase, conversely if the returns on assets are more less than the cost of debt, leverage will reduce the rate of return on capital. The greater the leverage used by a company, the greater the reduction. As a result, leverage can be used to increase profitability, but at the risk of increasing losses in dismal times. So the profits and losses will be enlarged by leverage, and the greater the leverage used by a company the greater the inaccuracy or ups and downs of profitability. Leverage is a double-edged sword which if the company's profit can be enlarged, and vice versa. In other words, the use of leverage in a company can increase a company's profits, but if something does not go as expected, the company can suffer losses (Roskha, 2017) [36].

Audit Quality

De Angelo (1981) defines audit quality as the probability that an auditor finds and reports about a violation in his audit accounting system. Audit quality is seen as the ability to enhance the quality of corporate financial reporting, with high audit quality expected to further increase investor confidence so that the market will react positively if the financial statements are audited by qualified auditors (Christiani & Nugrahanti, 2014) [9].

Audit quality is the suitability of audits carried out by auditors based on established audit standards (Watkins et al., 2004). In this study, audit quality was measured by the size of KAP auditing clients who were sampled. The Public Accountant Office (KAP) can be divided into two categories, namely KAP affiliated with the big four, namely KAP which is categorized as large scale and non big four KAP or KAP which are categorized as small scale. Previous research has found evidence that Big 4 has a higher level of accuracy in reporting GC opinions compared to non-Big 4 (Francis 2004; Geiger and Rama 2006). In other words, Big 4 has a lower reporting error GC than the big four non-Big KAP consisting of Pricewaterhouse Coopers, KPMG, Deloitte and EY. If the company whose financial statements are audited by KAP affiliated with the big four, it is given a value of 1, whereas if it is audited by a non big four KAP then it is given a value of 0.

The results of research conducted by Lucy Citra Fitriany (2016) show that Tax Planning has a significant influence on Earnings Management. This research is in line with Hapsari et al (2016) who conducted a similar study with the same results, where Tax Planning has a significant influence on Earnings Management. However, it is different from the research conducted by Aditama & Purwaningsih which states that Tax Planning has no effect on Profit Management, so researchers propose the following hypothesis:

H1 = Influential Tax Planning on Profit Management

Then for Leverage variables on Earnings Management there are several studies that have been conducted, including (Roskha, 2017) [36], where the results of these studies indicate that Leverage has an effect on Earnings Management. This is in line with the research conducted by Priharto, et al. (2018) [37] which states that Leverage has a significant effect on Earnings Management. But different from the results of research conducted by Gunawan and Waluyo (2015) [38] which states that leverage does not affect earnings management, so researchers propose the second hypothesis below:

H2 = Influential Leverage on Earnings Management.

Furthermore, for the Audit Quality variable several previous studies have been carried out, including those conducted by Rustiarini & Sugiati (2013) [39], where the results of the study stated that the size of KAP had an effect on Profit Management. But this is not in line with the research conducted by Dewi & Nugraharti (2014) [40] which states that Company Size has no effect on Profit Management. According to research conducted by Herianti & Marunda (2016) states that Audit Quality is able to moderate the relationship between Tax Planning and Earnings Management. In addition, according to research conducted by Naftalia & Marsono (2013) [41], states that Audit Quality can be moderating, so researchers propose a third hypothesis such as the following:

H3 = Audit Quality moderate the relationship of Tax Planning and Leverage on Profit Management.

Methodology

The approach in this study is to use a quantitative approach, and based on its objectives, this type of research is causal, namely research that explains the effect of an independent variable (independent variable and moderating variable) on the dependent variable (dependent variable). The independent variables in this study include the Intensity of Tax Planning and Leverage for the moderating variable namely Quality Audit and for the dependent variable in this study is Profit Management.

Definition and Operationalization of Variables

According to Bougie and Sekaran (2013) [42], variables are anything that can take different things or vary values. Values can be different at the same time the object or person is at the same time for different objects or people.

1. The dependent variable in this study is earnings management.

The measurement of the dependent variable in this study uses the Revenue Discretionary Model introduced by Stubben (2010) [32]. There are two formulas in the Revenue Discretionary Model which are used as a measure of earnings management. First is revenue model, this model focuses on income that has a direct relationship with accounts receivable. Second, the conditional revenue model, this model was developed again with the addition of company size (Size), company age (Age), and gross margin (GRM), as detail below:

$$\Delta AR_{it} = \alpha + \beta_1 \Delta R_{it} + \beta_2 \Delta R_{it} \times SIZE_{it} + \beta_3 \Delta R_{it} \times AGE_{it} + \beta_4 \Delta R_{it} \times AGE_SQ_{it} + \beta_5 \Delta R_{it} \times GRR_P_{it} + \beta_6 \Delta R_{it} \times GRR_N_{it} + \beta_7 \Delta R_{it} \times GRM_{it} + \beta_8 \Delta R_{it} \times GRM_SQ_{it} + \epsilon_{it}$$

AR = piutang akrual
R = annual revenue
SIZE = natural log dari total aset saat akhir tahun
AGE = umur perusahaan(year)
GRR_P = industry median adjusted revenue growth (= 0 if negative)
GRR_N = industry median adjusted revenue growth (= 0 if positif)
GRM = industry median adjusted gross margin at end of fiscal year
SQ = square of variable
Δ = annual change

2. In this study there are 2 independent variables whose relationship relates to the effect on earnings management, the firstly is company tax retention rate and secondly leverage.

$$TRR = \frac{Net\ Income_{it}}{Pretax\ Income\ (EBIT)_{it}}$$

-Net Income_{it} = company net profit i in year t.
-Pretax Income (EBIT)_{it} = corporate income before tax i in

Descriptive Statistics

	N	Minimum	Maximum	Mean	Std. Deviation
P_PAJAK	60	,42	1,16	,7596	,07641
LEV	60	,16	1,27	,5211	,24046
K_AUDIT	60	,00	1,00	,9500	,21978
M_LABA	60	-1,59	,35	-,4910	,40651
Valid N (listwise)	60				

year t.

Leverage is a tool to measure how much a company depends on creditors in financing company assets. Companies that have a high degree of leverage mean that they are very dependent on external loans to finance their assets (Jayanti, 2011) [43]. In this study tax planning is measured by total debt divided by total of assets. c. The moderating variable in this study is audit quality. It is the suitability of audits carried out by auditors based on established audit standards (Watkins et al., 2004) [44]. In this study, audit quality was measured by the size of KAP auditing clients who were sampled. The Public Accountant Office (KAP) can be divided into two categories, namely KAP affiliated with the big four, namely KAP which is categorized as large scale and non big four KAP or KAP which are categorized as small scale. The big four KAP consists of Pricewaterhouse Coopers, KPMG, Deloitte and EY. If the

company whose financial statements are audited by KAP affiliated with the big four, it is given a value of 1, whereas if it is audited by a non big four KAP then it is given a value of 0.

The population of this research is manufacturing companies listed on the Indonesia Stock Exchange. The sample used in this study is the LQ-45 company listed on the IDX. The sampling method used was purposive sampling which is sampling based on the following criteria: 1). Companies listed in the LQ45 category on the Indonesia Stock Exchange (IDX) 2). Companies that have statistical data and financial reports disclosed to the public from 2013 to 2017 to facilitate the calculation process in this study. 3). Companies that provide audited financial reports and audit reports for 2013-2017. 4). Companies that use rupiah in financial reporting.

Result and Analysis

Descriptive statistical results of Tax Planning, Leverage, Audit Quality and Profit Management variables show that: 1). The Tax Planning variable has the lowest value of 0.42 at PT Bukit Asam Coal Mining (Persero) Tbk, and the highest value is 1.16 at PT Bank Rakyat Indonesia (Persero) Tbk, the average value (Mean) is 0.7596 and has a standard deviation of 0.7461. 2). Leverage variable has the lowest value of 0.16 at PT Kalbe Farma Tbk, the highest value is 1.27 at PT Matahari Department Store Tbk, the average value is 0.5211 and the standard deviation is 0.24046. 3). Variables Audit quality has the lowest value of 0.00, that is, for companies audited by Non Big Four KAP, the highest value of 1.00 is for companies audited by the Big Four KAP, the average value of 0.9500 and the standard deviation is 0.21978. 4. Profit Management variable has the lowest value of -1.59, namely at Bukit Asam Coal Mine (Persero) Tbk, the highest value is 0.35, that is at PT Astra International Tbk, the average value of -0.4910 and the standard deviation is 0.40651.

From the descriptive statistic table shown the calculation of tolerance value shows that there is no independent variable that has a tolerance value of <0.10, the value of tolerance tax planning is 0.827, leverage is 0.876 and audit quality is 0.874. The VIF calculation results have no variable that has a VIF value > 10, where the tax planning VIF value is 1,270, leverage is 1,142 and audit quality is 1,145a and it can be concluded that free from multicollinearity.

T Test Result

Coefficients^a

Model	Unstandardized Coefficients		Standardized Coefficients	t	Sig.
	B	Std. Error	Beta		
(Constant)	1,826	,904		2,019	,048
P_PAJAK	-	1,180	-,473	2,131	,037
LEV	-	1,061	-2,474	3,944	,000
K_AUDIT	4,511	1,323	2,415	3,410	,001

a. Dependent Variable: Earnings Management

Based on the table above, it can be seen that the Beta value for the Tax Planning variable is -2,516 with a significant value of 0.37. in accordance with the provisions of first-way decision making, a significant value is less than 0.05 ($0.037 < 0.05$) then H1 is accepted. Based on the provisions of decision making the second way, if $t_{table} > t_{count}$ then H1 is accepted. Judging from the table ($df = 60-1-1$ ($n-k-1$); two sides / $0,025$) = 2,002 and $t_{count} -2,131 > 2,002$ then H1 is accepted. This means that Tax Planning has a negative effect on Earnings Management.

This states that every increase of 1 (one) in Tax Planning will reduce Profit Management by -22.156. Based on the table above it can be seen that the Beta value for the Leverage variable is -4.183 with a significant value of 0.00. in accordance with the provisions of the first way of decision making, a significant value is less than 0.05 ($0.00 < 0.05$) then H2 is accepted. Based on the provisions of decision making the second way, if $t_{table} > t_{count}$ then H2 is accepted. Judging from the table ($df = 60-1-1$ ($n-k-1$); two sides / $0,025$) = 2,002 and $t_{count} -3,944 > 2,002$ then H2 is accepted. This means that leverage has a negative effect on earnings management.

This states that every increase of 1 (one) on leverage, it will reduce profit management by -4,183. Based on the table above it can be seen that the Beta value for the Audit Quality variable is 4.511 with a significant value of 0.01. In accordance with the provisions of the first way of decision making, a significant value is less than 0.05 ($0.01 < 0.05$) then H3 is accepted. Based on the provisions of decision making the second way, if $t_{table} > t_{count}$ then H3 is accepted. Judging from the table ($df = 60-1-1$ ($n-k-1$); two sides / $0,025$) = 2,002 and $t_{count} 3,410 > 2,002$ then H3 is accepted. This means that Audit Quality is able to moderate the relationship between Tax Planning and Leverage on Earnings Management.

Conclusion and Recommendation

From the results of data analysis and the results obtained, the researchers made the conclusions of this study as follows:

1. Tax Planning has an effect on Profit Management with a significant level of 0.37. This is because companies that tend to do tax planning will also do earnings management to obtain a more efficient tax rate.
2. Leverage has an effect on Profit Management with a significant level of 0.00. This is because companies that tend to have high leverage ratios will do management because the company is threatened with default, ie it cannot fulfill its debt repayment obligations on time.
3. Audit Quality is proven to moderate the relationship between Tax Planning and Leverage simultaneously to Profit Management with a significant level of 0.001. Because companies audited by KAP Big Four tend to have a low level of fraud and tend to reduce the level of earnings management. This research has implications both theoretically and practically, including the results of this study can expand previous research, especially in research related to earnings management. For the company, the results of this study are expected to be a consideration for both owners and managers, so that it can be used as material to increase knowledge and insight into Profit Management, so that company management

can design mechanisms for implementing the company well, without illegally manipulating financial statements.

Moreover, limitations and suggestions in this study include:

1. Use of measuring instruments that have been used in previous research, suggestions for further research in order to use proxies or other measuring devices so that they get different results and can be compared with the results of previous studies.
2. The research area is still limited to a particular industrial sector, so the researcher suggests further research to be able to use a broader sample of companies such as companies in the best category of 100 companies by Fortune Magazine, or expanding in the Asia Pacific region and a wider time span. long so that it can be generalized better.
3. Does not expand to other possibilities in the measurement so the results can be biased. Further research is suggested to be able to measure and calculate audit quality with different measurements such as comparing the composite measure and can be compared with conventional measures in a wider area and more observable periods.
4. Measurement of earnings management uses only one model, suggestions for further research can use other models such as the Jones model for robustness testing, so that it can be compared and concluded more accurately.
5. The research variables used are not too broad, so further research is suggested to add other independent variables such as information asymmetry, Good Corporate Governance, Corporate Social Responsibility or Knowledge Management Systems that are considered to influence earnings management, and are still rarely done in previous studies.

References

- Susanto, I. R. (2017). Faktor-Faktor Yang Mempengaruhi Manajemen Laba Pada Perusahaan Manufaktur di BEI. *Jurnal Ilmiah Akuntansi Peradaban*, 3(2), 65-83.
- Sunarto. (2009). Teori Keagenan dan Manajemen Laba. *Kajian Akuntansi*, 1(1), 13-28.
- Sulistiyanto, S. (2008). *Manajemen Laba:Teori dan Model Empiris*. Jakarta: PT Grasindo.
- Anhara. (2015). Analisis Faktor-Faktor Yang Mempengaruhi Manajemen Laba (Studi Pada Perbankan Syariah di Indonesia). *Jurnal Tekun VI* (1), 128-150.
- Sari, N. H., & Ahmar, N. (2014). Revenue Discretionary Model Pengukuran Manajemen Laba: Berdasarkan Sektor Industri Manufaktur di Bursa Efek Indonesia. *Jurnal Akuntansi dan Keuangan*, 16 (1), 43-51.
- Barus, C. A., & Sembiring, Y. N. (2012). Faktor-Faktor Yang Mempengaruhi Motivasi Manajemen Laba Di Seputar Right Issue. *Jurnal Wira Ekonomi Mikroskil*, 2(1), 1-10.
- Eginius, S. (2016, 01 27). *PT Timah Diduga Buat Laporan Keuangan Fiktif*. Dipetik 12 26, 2018, dari Tambang.co.id.
- Arfianto, D. (2016, 01 27). *Direksi Timah Dituding Manipulasi Laporan Keuangan*. Diunduh pada 26 Desember 2018, pada <https://economy.okezone.com/read/2016/01/27/278/1298264/direksi-timah-dituding-manipulasi-laporan-keuangan>
- Christiani, I., & Nugrahanti, Y. W. (2014). Pengaruh Kualitas Audit Terhadap Manajemen Laba. *Jurnal Akuntansi dan Keuangan*, 16(1), 52-62.
- Prasetya, P. J., & Gayatri. (2016). Pengaruh Ukuran Perusahaan Terhadap Manajemen Laba Dengan Pengungkapan Corporate Social Responsibility Sebagai

- Variabel Moderating. *E-Jurnal Akuntansi Universitas Udayana*, 14(1), 511-538.
- Sari, N. K., & Asturi, D. D. (2015). Faktor yang mempengaruhi manajemen laba pada sektor perbankan Indonesia. *Journal of Business and Banking*, 5(1), 95-112.
- Yunita, S., & Darmawati, D. (2013). Analisis Pengaruh Kualitas Audit Terhadap Manajemen Laba dan Cost of Equity Capital : Studi Pendekatan Composite Measure. *Media Riset Akuntansi, Auditing & Informasi*, 13(1), 95-110.
- Putra, I. (2009). Manajemen Laba sebagai Perilaku Manajemen Opportunistic atau Realistic ? *E-jurnal Akuntansi Universitas Udayana*, 6(1), 1-21.
- Maulana, A. (2014). Faktor-Faktor Yang Mempengaruhi Praktik Perataan Laba di Perbankan. *Jurnal Akuntansi dan Investasi*, 15 (2), 137-150.
- Zain, M. (2003). *Manajemen Perpajakan*. Jakarta: Salemba Empat.
- Utami, P. S., & Meiranto, W. (2017). Analisis Faktor-Faktor Yang Mempengaruhi Manajemen Laba (Studi Empiris Pada Perusahaan Manufaktur yang Terdaftar di Bursa Efek Indonesia Tahun 2013-2015). *Diponegoro Journal of Accounting* 6 (3), 1-10.
- Sambora, M. N., Handayani, S. R., & Rahayu, S. (2014). Pengaruh Leverage dan Profitabilitas Terhadap Nilai Perusahaan (Studi pada Perusahaan Food and Beverages yang terdaftar di BEI periode tahun 2009 – 2012). *Jurnal Administrasi Bisnis (JAB)*, 8(1), 1-10.
- Ramadhan, R. (2017). Analisis Faktor Yang Mempengaruhi Manajemen Laba Pada Perusahaan Manufaktur Yang. *Prosiding Seminar Nasional dan Call For Paper Ekonomi dan Bisnis*, 464-476.
- Amijaya, M. D., & Prastiwi, A. (2013). Pengaruh Kualitas Audit Terhadap Manajemen Laba. *Diponegoro Journal of Accounting* 2 (3), 1-13.
- Dewi, N., & Jati, I. (2014). Pengaruh Karakter Ekdektif, Karakteristik Perusahaan, dan Dimensi Tata Kelola Perusahaan yang Baik Pada Tax Avoidance di Bursa Efek Indonesia. *E-Jurnal Akuntansi Universitas Udayana*, 6(2), 249-260.
- Herianti, E., & Marundha, A. (2015). Pengaruh Kualitas Audit Terhadap Hubungan Antara Perencanaan Pajak dan Manajemen Laba. *Seminar Nasional dan The 3rd Call for Syariah Paper*, 450-458.
- Nihlati, H., & Meiranto, W. (2014). Analisis Pengaruh Kualitas Audit Terhadap Earnings Management. *Diponegoro Journal Of Accounting*, 3(3), 1-10.
- Jasen, M., & Meckling. (1976). Theory of the Firm : Managerial Behavior, Agency Costs and Ownership Struktur. *Journal of Financial Economics*, 305-360.
- Chariri, 2008. Kritik Sosial Atas Pemakaian Teori Dalam Penelitian Pengungkapan Sosial Dan Lingkungan, Semarang: Jurnal Maksi, Vol. 8 No.2, 2 Agustus 2008: 151-169.
- Gargauri, R., & Ridha Shabau. (2010). The Relationship between Corporate Social Performance and Earnings Management. *Canadian Journal of Administrative Sciences*, 27, 320-334.
- Scott, William R. (2011). *Financial Accounting Theory*. Sixth Edition. Canada: Person Prentice Hall.
- Zumrotun, N. (2013). Manajemen Laba Ditinjau Dari Sudut Pandang Praktisi dan Akademisi. *Jurnal STIE Semarang*, 5(2), 93-102.
- Healy, P., dan Wallen J, 1999, Tinjauan Literatur Manajemen Laba dan Implikasinya terhadap Standart Pengaturan, Akuntansi Cakrawala Hal 12.
- Scott, W.R. 2009. *Financial Accounting Theory*. 5th edition. Prentice Hall Inc. Canada, Ontario.
- Watts, Ross L. dan Jerold L. Zimmerman (1986). *Positive Accounting Theory*. USA: Prentice-Hall.
- Jones, Jennifer J, 1991. Earnings Management During Import Relief Investigations. *Journal Of Accounting Research*, Vol 29, No.2 1991, p.193 –228.
- Stephen R. Stubben. 2010. Discretionary Revenues As A Measure Of Earnings Management. *The Accounting Review* Vol. 85, (2), Pp. 695–717.
- Muljono, D. (2009). *Tax Planning*. Yogyakarta: Penerbit C.V Andi Offset.
- Suandy, Erly. 2011. *Hukum Pajak*, Edisi 5, Jakarta: Salemba Empat.
- Van Horne, James C. and John M. Wachowicz. 2007. *Fundamentals of Financial Management, Prinsip-Prinsip Manajemen Keuangan*. Jakarta : Salemba Empat.
- Roskha, Z. (2017). Pengaruh Leverage, Good Corporate Governance dan Ukuran Perusahaan Terhadap Manajemen Laba. *Jom Fekom*, 4(1), 221-235.
- Priharta, A; Rahayu, D.P & Sutrisno, B. (2018). Pengaruh CGPI, Kualitas Audit, Ukuran Perusahaan dan Leverage Terhadap Manajemen Laba. *Journal of Applied Business and Economics* Vo. 4 No. 4. Juni 2018.
- Gunawan dan Waluyo. 2015. *Risk Based Behavioral Safety Membangun Kebersamaan Untuk Mewujudkan Keunggulan Operasi*. Jakarta: PT Gramedia Pustaka Utama.
- Rustiarni dan Sugiarti. 2013. “Pengaruh Karakteristik Auditor, Opini Audit, Audit Tenure, Pergantian Auditor Pada Audit Delay”. *Jurnal Ilmiah dan Humanika*, volume 2, nomor 2, Singaraja.
- Dewi, LC dan Nugrahati. 2014. Pengaruh struktur kepemilikan dan dewan komisaris independen terhadap nilai perusahaan (Studi pada perusahaan industri barang konsumsi di BEI tahun 2011–2013). *KINERJA*, Volume 18, No.1, Th. 2014: Hal. 64-80.
- Naftalia, V. C., dan Marsono. 2013. Pengaruh Leverage terhadap Manajemen Laba dengan Corporate Governance sebagai Variabel Pemoderasi, *Diponegoro Journal Of Accounting*, Vol. 2, No. 3, hal. 1-11.
- Bougie, & Sekaran. (2013). *Edisi 5, Research Methods for Business: A skill Building Approach*. New York: John wiley@Sons.
- Jayanti, P. (2011). Analisis Pengaruh Size, Profitabilitas dan Leverage Terhadap Pengungkapan CSR. *Tugas Akhir*.
- Watkins, A.L. et al. 2004. “Audit Quality: A synthesis of Theory and Empirical Evidence”. *Journal of Accounting Literature*. 23 (153-193)

Student's Perceptions of the Role of Politeness in Online Communication

Ayu Meiratnasari

Post-Graduate Program of English
Department

Universitas Sebelas Maret
Surakarta, Indonesia

ayumeiratnasari@gmail.com

Agus Wijayanto

Post-Graduate Program of English
Department

Universitas Sebelas Maret
Surakarta, Indonesia

aguswijayanto@ums.ac.id

Suparno

Post-Graduate Program of English
Department

Universitas Sebelas Maret
Surakarta, Indonesia

Surakarta, Indonesia

Abstract—English has the primary role as a communication tool in industrial revolution 4.0 because it was an international language. In this era, the developments of technologies facilitated people around the world to communicate through social media, email, website, and others. Through those communications, they can enhance their business, developing their studies, or expanding their relations. However, every country has its norms in conversation, so that politeness strategies are the core component in achieving the successfulness of communications. This study was one of qualitative research which primarily focuses on exploring the student's perceptions on the role of politeness strategies in using English in online communication. The data was collected by delivering the questionnaire to the 40 students in SMA Negeri 1 Kretek Bantul, Yogyakarta, Indonesia, and interviews with some of them. The data of this study were analyzed using a content analysis approach. The results described that the students consider politeness strategies as their policies during the communications. The implications of this study were to help the teachers identify the student's need in the development of politeness strategies and to prevent miscommunication during the online communication process.

Keywords— Politeness Strategies, Indonesian EFL Learners, Online Communication, Digital Era

INTRODUCTION

Politeness strategies are considered as one of the crucial element to determine the successfulness of communication. In this digital era, communication does not only face-to-face communication, but there is also online communication. The development of technology communication brings the researchers in the last two decade investigating the use of politeness strategies in computer-mediated communication (CMC), (Saidi & Khosravi, 2015). Follows are some of the researchers who investigated the politeness strategies in CMC.

First, Li (2012) look into how the small group of English foreign language (EFL) learners utilizes politeness strategies in the wiki space. Her study found that politeness strategies are a

significant aspect of developing group contribution and cooperation. It also leads to the successfulness of interpersonal interaction. Second, Adel, Davoudi and Ramezanzadeh (2016) who is their study, revealed that Iranian EFL learners used positive politeness to show their solidarity and friendship during the blog class. Third, Kavanagh (2016) who studied on emoticon as a reflection of politeness strategies in American and Japanese blog communities revealed that both of American and Japanese have the same reason in using the emoticon as a reflection of positive and negative politeness. They used it to assist the progress and maintenance of harmonious relation during online communication in the blogging community.

Moreover, the development of communication also brings several researchers interested in exploring politeness strategies in the social network. For example, the study comes from Maros and Rosli (2017). Their investigation of the twitter updates of female Malaysian undergraduate students of English language studies discovered that the students frequently used positive politeness because the nature of CMC encourages interpersonal communication and expression between the users. Another research comes from Flores-Salgado & Castineira-Benitez (2018). Their research on the politeness in *WhatsApp* group of Mexican Spanish users revealed that the members of the groups used politeness strategies to establish the norm of communication, to sustain the social relationship, and to achieve the communicative goals.

Regarding the importance of politeness strategies in the online communication such as explained in the previous studies and the culture of Indonesia is different from the area in the previous study, so the present study is conducted to explore Indonesian student's perception about the role of politeness strategies in online communication. The researcher conducts the research questions such as follows:

1. How does the student's perception of politeness strategies in using English in online communication?

LITERATURE REVIEW

Perception

Perception is a mental process involving the five sense of human to interpret an event or object (Stone & Nielson, 1985). Leather (1992) stated that perception is a cognitive process used by human to evaluate their surrounding environment. Perception is the cognitive process which involves the internal

and external stimuli to understand, view, and act about the meaningful information of the world around them. So, perception is not only about having opinion or belief about something but also about how the individual using the information that they have perceived in the future

Politeness Strategies

Politeness can be explained as the quality of showing or having good character and consideration for others. Politeness strategies are the attitude to maintain the feeling of others so that they believe in treating well (Brown, 2015). Positive politeness, negative politeness, bald on-record, and off-record are four kinds of politeness strategies which realize in the language (Brown & Levinson, 1987).

Online Communication

Online communication is authentic as offline interaction (Locher, 2010) because it such a place to allocation the verbal language components which are taken from both the written and spoken language. In the online communication, language is used to convey the actions and behaviors, while emoticons, videos, and GIFS are used to convey physical action and emotion, (Rezabeck & Chocenuor, 1994; Derks, Bos & Grumbkow, 2007).

METHODOLOGY

This study intends to explore the student's perceptions of the role of politeness strategies in using English in online communication. The other methodology components of this research will be explained as follows:

Participants

The participants of this research are the second-grade students of SMA Negeri 1 Kretek Bantul, Yogyakarta, Indonesia. The research is conducted during the English class. Forty students were chosen randomly by the researcher as the sample of this study.

Instruments

There are two kinds of the instrument in this research. The researcher used two kinds of data collection method as the data triangulation to get the validity of the data.

Questionnaire. The questionnaire contains ten questions, such as follows:

TABLE I QUESTIONNAIRE OF STUDENT'S PERCEPTION OF POLITENESS STRATEGIES IN ONLINE COMMUNICATION

No	Questions	Y	S	N
1	Can politeness strategies help the students to maintain harmony in online communication?			
2	Are the politeness strategies able to foster mutual understanding during online communication?			
3	Can politeness strategies affect the foreigner's perception of Indonesia when the students converse with foreigners through online media?			
4	Do the politeness strategies help student's online communication with foreigners be more effectively?			

5	Can politeness strategies help the students to apply values and norms in online communication?			
6	Can politeness strategies protect the student's face when communicating with foreigners in online media?			
7	Can politeness strategies help the students to accept and give opinion efficiently during online communication?			
8	Do the uses of politeness strategies in online communication expand network?			
9	Can the politeness strategies strengthen the relationship among the participants in online communication?			
10	Can the politeness strategies minimize the debate in online communication?			

*Note: Y=Yes, S=Sometimes, N=No

- Interview. The interview is conducted to get the validity of the data. So, the researcher asks the students with one simple questions such as “How does your perception about the role of politeness strategies in online communication? Especially in using English to communicate”. Due to the limited time for the interview session, the researcher interviewed six students who volunteered to do the interview.

Data Analysis Method

The researcher used content analysis by Denscombe (2010) to analyze the data. There were six steps in the content analysis by Denscombe’s study. First, the researcher analyzes the questionnaire and transcripts the interview. During this process, the researcher also chooses the appropriate sample of text to be analyzed in the next step. Second, the researcher breaks the chosen text into the smallest component units. Then, the researcher developed some categories of relevant data to analyze the data. Fourth, coding the data units based on their categories. Fifth, calculate the frequency of how many times the data units occur. For instance, the steps can be described as follows:

TABLE II. THE FRAME OF THE QUESTIONNAIRE ANALYSIS

No	Component Units	Code	Frequencies		
			Y	S	N
1	Maintain the harmony	Q1			

*Note: Q1= Question number 1, Y= yes, S=Sometimes, N= No

The last step was analyzing the data based on their unit frequencies and their relation with the other units in the questionnaire. The same steps were applied to analyze the data interview.

FINDINGS, DISCUSSIONS, AND CONCLUSIONS

Findings

There were two kinds of findings in this research which will be presented as follows:

- The result of the questionnaire

TABLE III. THE RESULT OF THE QUESTIONNAIRE ANALYSIS

No	Component Units	Code	Frequencies		
			Y	S	N
1	Maintain the harmony	Q1	32	8	0
2	Foster mutual understanding	Q2	30	9	1
3	Effect the foreigner's perceptions of Indonesia	Q3	25	9	6
4	Help the communication more effective	Q4	22	16	2
5	Help to apply value and norms of communication in online communication	Q5	31	9	0
6	Help to save face during the online communication	Q6	29	11	0
7	Help to give and accept opinion efficiently	Q7	24	16	0
8	Expanding the networking/relations	Q8	27	12	1
9	Strengthen the relationship between the participants	Q9	25	15	0
10	Minimize the debate	Q10	21	18	1

The result of the questionnaire in Table 4 showed that the students seem to have ethical perceptions about the role of politeness in online communication. As can be seen in Table 4, as many as 32 students perceived that politeness strategies could help them to maintain harmony during online communication. It also showed that 25 students felt that politeness strategies could affect the foreigner's perception of Indonesia. It seems like when the students do online communication with the foreigners; they will assume how the Indonesian is based on the student's behave in online communication. Besides, 22 students believed that politeness strategies help them to communicate effectively during online communication. It may cause of politeness strategies facilitate the students to apply vale and norm in online communication; 31 students perceived about it.

Moreover, the students also perceived that politeness strategies help them to save their face or their pride during online communication, 29 students said yes about it. It also supported by 24 students who seem believed that politeness strategies in online communication can help them to give and accept different opinion efficiently. Because of the politeness strategies in online communication, 27 students supposed to expand their network or relation. It was the effect of the participants in the online communication can strengthen their relationship by applying politeness strategies. Based on Table 4, 25 students have that kind of the point of view. The students also perceived that the role of politeness strategies in online communication could minimize the debate among the participants. There we 21 students who make sure about it.

- The result of the interview

Some points can be making sure based on the interview result. First, politeness strategies in online communication have a role in maintaining harmony during online communication. It is also leading the successfulness of communication goal. The conclusion is based on the statement of the students below:

"In my opinion, politeness strategies play a role in maintaining harmony in online communication. If we speak or write politely during online communication, the audiences will give their respect and willingness to listen to us properly. So, the communication will go well, and our goals of communication can be achieved" (IR/S1)

Second, the students perceived that politeness strategies in online communication have a role in minimizing the conflict among the participants. It is based on the student's interview responses below:

"I think politeness strategies also play a role as a guideline when we talk to people who are different from our country. The possibility of misunderstanding can minimize by considering the politeness" (IR/S2)

"Politeness strategies are used to respect each other during communication. When we are in online communication or communicate with foreign citizens, we have different cultures, norms, and rules. If we are polite, we can avoid the conflict with the other participants" (IR/S5)

Third, the students perceived that politeness strategies in online communication are used as self-identity, which can affect the foreigner's perceptions of Indonesia. It can be seen in the student's statement below:

"According to me, when we talk to people from other countries in a polite manner, it will affect the perceptions of them towards us. The communication can also influence the perceptions of other citizens towards our country, namely Indonesia. I believed that when we interact with people from other countries or in the online forum, they are not only judging ourselves but also evaluating where we come from" (IR/S3)

"Politeness has a role as self-identity and country-identity. That is, when we as Indonesian citizens communicate politely, the foreigners will surely judge Indonesia as a good and friendly country" (IR/S4)

Last, the result showed that the students believed that politeness strategies in online communication have a role in expanding their relations or friends. It reflected in the student's interview response below:

"Politeness strategies play a role in expanding networking. I had experience making a friend on the online forum" (IR/S6)

Discussions

Based on the findings of the questionnaire and interview, the researcher found that Indonesian students have a positive perception of the role of politeness strategies in online communication. It revealed that the students perceived some point of view about the role of politeness in online communication such as follows:

First, politeness strategies help the students to maintain harmony in online communication and leading the success of communication goals. This result is in line with the previous

study conducted by Li (2012). In her research, Li (2012) revealed that politeness strategies in the wiki space lead the successfulness of interpersonal interaction. The result also matches with the study conducted by Kavanagh (2016). Kavanagh (2016) discovered that the uses of politeness strategies in the blogging community are to maintain the harmony of the communication among the members of the blogging community. This result showed that communication through the online space could happen as authentic as offline or face-to-face communication (Locher, 2010)

Second, politeness strategies help the students to minimize the conflict during online communication. Maros and Rosli (2017) can relate to the result of the present research. Their investigation of politeness strategies used by females undergraduate students in twitter revealed that it encourages interpersonal communication and expression between the users. Another research that can relate to the result of the present study comes from Flores-Salgado and Castineira-Benitez (2018). Their research on the politeness in *WhatsApp* group of Mexican Spanish users revealed that the members of the groups used politeness strategies to establish the norm of communication, to sustain the social relationship, and to achieve the communicative goals. This result means that online communication has a significant risk of conflict due to intercultural communication will happen in online space. So, politeness strategies facilitate the participants of the online community to avoid the problem.

Third, politeness strategies in online communication help the students in expanding their friends or relation. Adel et al. (2016) have resembled findings with the present study. Their study revealed that Iranian EFL learners used positive politeness to show their solidarity and friendship during the blog class. Politeness strategies are the attitude to maintain the feeling of others so that they believe in treating well (Brown, 2015). So that is why the present study proves that politeness strategies have a role in expanding friendship and relation. It proves that human is expecting to treat appropriately by people. If people feel happy and comfortable when communicating with someone, they will intend to have a good relation with him.

Politeness strategies which applied in online communication can affect the foreigner's perception toward Indonesia. This result seems like something new that has not found in the previous study. It may cause a different culture between Indonesia and the other countries where the previous researcher was conducting their research. So, the different culture, environment, and behavior can lead a different way in perceiving something.

Conclusions

This study aimed to explore the student's perceptions about the role of politeness strategies in online communication. The results showed that Indonesian students have some positive perceptions about the role of politeness strategies in online communication such as follows: (1) politeness strategies help the students to maintain the harmony in the online communication and leading the success of communication goals, (2) politeness strategies help the students to minimize the conflict during online communication, (3) politeness strategies in the online communication help the students to expand their friends or

relation, and (4) Politeness strategies which applied in online communication can affect the foreigner's perception toward Indonesia.

ACKNOWLEDGMENT

The researcher wishes to thank the English teacher in the SMA Negeri 1 Kretek Bantul, Yogyakarta, Indonesia. The researcher also would like to thank the students who willing to participating in this research. Best regard for the researcher's supervisions and the researcher gratitude also sends to the anonymous reader who may interest in this kind of study and would like to give the researcher valuable feedback.

REFERENCES

- Adel, S. M. R., Davoudi, M., & Ramezanzadeh, A. (2016). A qualitative study of politeness strategies used by Iranian EFL learners in a class blog. *Iranian Journal of Language Teaching Research*, 4(1), 47-62.
- Brown, P., and Levinson, S. C. (1987). *Politeness: Some universals in language usage*. Cambridge: Cambridge University Press.
- Brown, P. (2015). Politeness and language. In *The International Encyclopedia of the Social and Behavioural Sciences (IESBS)*, (2nd ed.) (pp. 326-330). Elsevier.
- Denscombe, M. (2010). *The good research guide for small-scale social research project* (4th ed.). England: Open University Press.
- Derks, D., Bos, A. E., & Grumbkow, J. V. (2007). Emoticons and online message interpretation. *Social Science Computer Review*, 26(3), 379-388.
- Flores-Salgado, E., & Castineira-Benitez, T. A. (2018). The use of politeness in whatsApp discourse and move 'request'. *Journal of Pragmatics*, 133, 79-92.
- Kavanagh, B. (2016). Emoticon as a medium for channeling politeness within American and Japanese online blogging communities. *Language & Communication*, 48, 53-65.
- Leather, D. G. (1992). *Successful in verbal communication: principle and application*. Massachusetts: Addison Wesley Publishing Company.
- Li, M. (2012). Politeness strategies in wiki-mediated communication of EFL collaborative writing task. *The International Association for Language Learning Technology Journal*, 42(2) 1-26.
- Locher, M. (2010). Politeness and impoliteness in computer-mediated communication. *Journal of Politeness Research*, 6, 1-5.
- Maros, M., & Rosli, L. (2017). Politeness strategies in twitter updates of female English language studies Malaysian undergraduates. *3L: The Southeast Asian Journal of English Language Studies*, 23(1), 132-149.
- Rebeczk, L. L., & Cochenouor, J. J. (1994). Emoticons: Visual Cues for Computer-Mediated Communication. In: *Imagery and Visual Literacy: Selected Readings from the Annual Conference of the International Visual Literacy Association*. Retrieved from <http://files.eric.ed.gov/fulltext/ED380096.pdf>
- Stones, & Nielsen. 1985. *Educational psychology: The development of teaching skills*. Massachusetts: Addison Wesley Publishing Company.

Edutainment with the Help of Volcanic Media for the Development of Children's Language in Group B at TK X Kamal, Bangkalan

Dwi Nurhayati Adhani

Lecturer at PG PAUD Universitas Trunojoyo Madura
Madura, Indonesia
adhaniuwi@gmail.com

Ainin Shofiyah

Dian Ceria Kindergarten Teacher Surabaya
Yogyakarta, Indonesia
aeninshofiyah@gmail.com

Abstract—*This study aims to look at the development of language owned by group B children in TK X Kamal, Bangkalan using edutainment. On the implementation of using mountain media erupted by performing a volcanic eruption process simulation. Learning about volcanic eruptions is expected to enable children to get to know the environment, and explain the symptoms of nature. This study uses quantitative descriptive research to determine the number of students who can describe the process of erupting the mountain verbally. The location of this study was conducted at TK X kamal Bangkalan with a total of 16 students. The results of this study were to look at the language development of children in group B in explaining natural phenomena such as volcanic eruptions.*

Keywords—*edutainment, language development, volcanic erupted media*

I. INTRODUCTION

Education is an important aspect of human life. Education if likened to oxygen (O₂) in everyday life. The most important period of human life to form a whole person is childhood. In childhood or what is commonly called early childhood is a period that many several figures are the golden age. The golden age is the development period with an indicator of 80% of the developing brain so that the role of parents is needed to monitor the growth and development of the brain (Kompas, 2008).

Education is one of the rights of children that must be fulfilled. It is also supported by a law that states that the State guarantees its citizens to obtain education. Education for early childhood is education which aims to optimize the development of a child to prepare children later in adulthood. The development of a child has several developmental aspects including physical / motoric, language, social, emotional, language, moral, and artistic creativity.

One important development in children is one of language development. The development of children's language is a development that is expressed by using words that mark an increase in the ability and creativity of children (PAUD Jateng, 2015). Language is the most important thing for children to communicate, express thoughts, feelings from children.

The beginning of language development starts from infancy and continues according to the role, experience in mastering, and growth of language (Wyeth, 2017). Language development has several indicators according to the stages of age. Every child experiences some age differences in achieving the language development indicator, some are slower or some are faster. However, there is not much age difference in going through these indicators.

Language development in early childhood especially in children aged 5-6 years has characteristics such as children have begun to understand the words of others, not only the language for themselves but can communicate with others, for example expressing rejection, admiration, interacting with peers. Language can also be an indicator of whether a child experiences developmental delays, for example in cognitive, sensorimotor, psychological and emotional development (Wyeth, 2017).

Language development can be optimized using the application of edutainment. The concept of edutainment itself actually exists when new children are born to get to know their world, they play with themselves, and the environment as a form of learning about the environment (White, 2016). Edutainment is learning that is mixed with entertainment concepts. Edutainment itself can be done in class or outside the classroom, even using audio video tools, radio, using toys, tv, podcasts, inviting museums (Edsys, n.d.).

Based on the above explanation, this study would like to see how the concept of edutainment with the help of continuous mountain media can affect the language development of 5-year-olds at TK X Kamal, Madura.

II. FRAMEWORK THEORY

A. Early Childhood

Early Childhood is the period from birth to age 8 years, marked at this age there is a rapid development of the brain and continues to increase. At this stage, children are very much influenced by the environment and the people around them (UNESCO, 2019).

B. Feedback on Form vs Feedback on Content

Language is a communication tool used by someone to connect with other people. Language is a communication tool, so that a human being becomes effective and can communicate with others. Stages of language development

Early Childhood Language Function

Language function in early childhood is (Mulyani, 2018, p. 107):

- 1) Become a tool for communicating with the surrounding environment
- 2) Become a tool for developing cognitive abilities of children
- 3) Become a tool to be able to develop children's expression
- 4) Becoming a tool to be able to express feelings and forms of mind to others.

C. Definition of Edutainment

The definition of edutainment itself according to Sutrisno (2015, p. 31) is a form of learning process that is designed by combining education and entertainment harmoniously so that learning activities become enjoyable.

III. RESEARCH METHODS

The approach used in this study uses quantitative research with experimental methods. The purpose of using the experimental method is to see the effectiveness of the application of edutainment with the help of the media gunung erupsi for the development of children's language group B at TK X Kamal.

This study uses one group pre-test-posttest design. This study uses pretest-posttest to see the language skills of children in kindergarten B before and after the treatment is given.

A. Pretest-Posttest One-Group Design Chart

Information:

O1 = value of pretest (before being treated)

O2 = posttest value (after being treated)

X = treatment given (independent variable).

This study uses a non-probability sampling using 16 children from TK X in Kamal. The population of this study were 16 children with saturated populations so that all children included in TK B were included in the treatment. The sample in this study used saturated samples by including all 16 children.

IV. RESULT AND DISCUSSION

This research was conducted at RA Dewi Sartika Kamal. In accordance with the research objectives that have been formulated, this study aims to determine the effect of eruption media assisted simulation methods on language skills in children in group B.

The treatment given in the form of the application of a simulated eruption method assisted by mountain media which was carried out twice before treatment was given. The subjects of the study were given a pretest to determine the initial ability before treatment. After the treatment has been given to the child, the final assessment (posttest) is carried out using the same instrument, namely the observation instrument to see the child's language skills.

Indicators in this study there are 4 indicators including Communicating, Knowing vocabulary, Identifying symbols, and Hearing and narrating then developed and adapted to the needs of researchers into 8 items of statements where from each indicator there are 1 and 2 statements.

The research method used in this study is the experimental research method. The researcher used a type of one-group pretest-posttest design, in this type of one-group pretest-posttest design there will be a pretest before giving a treatment. The existence of this pretest will be known more accurately, because it will be able to compare with the situation before being given treatment and after being given treatment. The prerequisite test for data analysis in this study is to find out data including normal distribution or not normally distributed. Based on observations it is known that the assessment of children before treatment consists of 7 undeveloped children (BB) and 8 children classified as developing (MB) and 1 child classified as developing according to expectations (BSH). The following data results before treatment (pretest)

The implementation of treatment using edutainment with volcanic media on the ability of language to speak in children has increased, there are 5 children included in the category of developing according to expectations (BSH), and 11 children included in the very well-developed category (BSB).

After knowing the results of the observations made, To find out the normal data or not, the researcher calculated the data by Liliefors test for normality test, the results show abnormal data and then did the calculation test using the nonparametric test level test marked Wilcoxon.

TABLE III HASIL UJI NORMALITAS

Variable	the highest L-value	L table
Pretest	0,6700	0,213
Posttest	0,8070	0,213

Pretest variables are normally distributed, if $L\text{-value} \leq L\text{-table}$. In the Pretest variable with a significant level of 0.05, the highest L-value value was 0.6700 while L-table was 0.213. So the value of $L\text{-value} > L\text{-table}$. Based on these results, it can be concluded that H_a is accepted and H_0 is rejected. This means that pretest data is abnormally distributed

Posttest variable is normally distributed, if $L\text{-value} < L\text{-table}$. In the Posttest variable with a significant level of 0.05, the highest L-value value was 0.8070 while L-table was 0.213. So the value of $L\text{-value} > L\text{-table}$. Based on these results, it can be concluded that H_a is accepted and H_0 is rejected. This means that the Posttest variable data is normally distributed. Both variables are abnormally distributed.

B. Discussion

The use of simulation methods in children can develop language skills in science activities with erupting mountain media simulations. One method that can be applied in science learning in children is a simulation method. According to Fadlillah (2014), the simulation method is learning that is done by imitating a particular action or activity, so that it can be stimulated more optimally for the material provided through the simulation method

With this method children can learn about science related to natural symptoms, one of which is the symptom of a volcanic eruption. Children are expected to be directly involved in the erupting mountain simulation learning process so that children can find out the process of erupting mountains.

Based on observations before the treatment that the child is not maximized in the language to communicate appropriately. When asked to tell the process of the occurrence of a mountain simulation erupting the child was still in doubt. Similarly, when mentioning the types of tools and materials used in the erupting mountain simulation activities.

Through direct simulation activities the treatment of children can do more good skills to communicate, scream and learn and explain the process of erupting and more energetic mountain simulation activities so that the material provided is more easily absorbed by children using the simulation method of children's language skills.

The involvement of children in learning provides a very valuable experience. Children will begin to learn from the events they experienced. Children learn to recognize the symptoms of volcanic eruptions so that children can understand the processes and causes of volcanic eruptions. The involvement of children when giving treatment provides new knowledge during learning activities that have an impact on ability.

REFERENCES

- Edsys. (n. d.). What is edutainment? How is it beneficial for kids? Retrieved from <https://www.edsys.in/edutainment-beneficial-kids/>
- Fadhillah, M. (2014). *Edutainment pendidikan anak usia dini*. Jakarta: Prenada Media.
- Kompas.com. (2008, December 20). 80 Persen otak anak berkembang di usia emas. Retrieved from <https://nasional.kompas.com/read/2008/12/20/10101819/80.persen.otak.anak.berkembang.di.usia.emas>
- Mulyani, N. (2018). *Perkembangan dasar anak usia dini*. Yogyakarta: Gava Media.
- PAUD Jateng. (2015, September 26). Pengertian perkembangan bahasa anak usia dini (PAUD). Retrieved from <https://www.paud.id/2015/09/perkembangan-bahasa-anak-usia-dini.html>
- UNESCO. (2019). Early childhood care and education. Retrieved from <https://en.unesco.org/themes/early-childhood-care-and-education>
- White, R. (2016, June 25). Children's edutainment centers: Learning through play. Retrieved from <https://www.whitehutchinson.com/leisure/articles/76.shtml>
- Wyeth. (2017, September 10). Kenali tahapan perkembangan bahasa anak usia dini. Retrieved from <https://www.wyethnutrition.co.id/kenali-tahapan-perkembangan-bahasa-anak-usia-dini>

The Power of Myths on Environmental Preservation in Bali

Gek Wulan Novi Utami

Dhyana Pura University

Badung, Indonesia

wulannoviutami@undhirabali.ac.id

Abstract—*This research aims to find out the myths' power relating to environmental preservation in Bali. Myth is human creation that is rich of social and culture value within it to describe phenomena around them. Myth is still exist even it turns into behavioural reference in Bali, moreover, Balinese rites are very strong bounding people although modernization develops rapidly. It is assumed that myths ecology-related correlate to semiological system that covers signifier, signified, and sign which are potential influencing human perception and behaviour to preserve environment. This research uses descriptive-qualitative approach. The data is collected by depth-interview method and probing technique. Ecolinguistics' framework especially social praxis related that consists of three dimensions, namely a bio-logical, a socio-logical, and an ideological dimension, and also culture approach contributing in analyzing data. It concludes that myths' existence is very strong; it is powerful relating its impact to human, but powerless toward environment preservation.*

Keywords— *Myth, Ecolinguistics, Social, Environmental preservation, Bali*

I. INTRODUCTION

This research aims to find out the myths' power relating to environmental preservation in Bali. It assumes that myths ecology-related correlate to semiological system that covers signifier, signified, and sign which are potential influencing human perception and behaviour to preserve environment. Myth is considered as fable or heroic tales since long time ago but recently "myth" word refers to stories that relate to history or ethnology especially sacred ritual in certain speech community (Itu, 2010). The Myth existence cannot be separated from language and culture around it in the same environment as quoted "the myth is the saying and the ritual is the doing" convinces that there is linkages between myth and language and also rite as part of culture (Frazer in Itu, 2010). Three important units that stated before, live in a certain environment, they interact, being interdependent, and involving ecology aspect that strengthen myth existence through their interactions. Furthermore, in order to know the structure of human mind's mechanism, myths phenomena are needed because social phenomenon cannot be covered and even it cause more questions about that structure (Strauss, 2001, p. 75-76).

Mentioning human mind, remind us about cognitive and mediating scheme that is said that conceptual abstract within brain intercedes and bridges stimulant reception of stimulants by sensory devices and behavioural response (Wallace in Casson, 1981, p. 19). Relating to myth that is known and believed by speakers in certain environment and

idiosyncrasy scheme and culture take part in this case. Idiosyncrasy scheme makes human mind unique such as remembering name, date, arranging routines, and believing a belief based on their experiences. Another scheme; cultural scheme, that happen in certain community members such as plants and animals taxonomy, disease diagnosis procedure, and custom regulations in certain community (Casson, 1981, p. 20-21). Myth is formed by the smallest units of stories that are gathered containing sign and symbol (Strauss, 2001). Dister (in Daeng, 2000) stated that the myth reference frame make human orientating to life's origins. Mbete (2014) stated that human as speaker realizes the existence of a number of forms and meaning of certain words in timeline contextually and contemporarily which is dynamic, variative, and creative. The relationship of speech community, myth, and mythical creatures in a circumstance, and also relating to ecology cannot be separated from Tri Hita Karana concept in Bali. That concept covers the existence of harmonious relationship among God or ancestors, human, and environment. Knowing that elements make writer more focus to conduct this research and find out myth's power toward environmental preservation in Bali. Some related research have been conducted; they are Eidinow's research (2016) entitled "Telling stories: Exploring the Relationship between Myths and Ecological Wisdom", Iswidayanti's research (2007) entitled "Fungsi Mitos dalam Kehidupan Sosial Budaya Masyarakat Pendukungnya (The Function of Myth in Social Cultural Life of Its Supporting Community)", Sufia, Sumarmi, and Amirudin research (2016) entitled "Kearifan Lokal dalam Melestarikan Lingkungan Hidup (Studi Kasus Masyarakat Adat Desa Kemiren Kecamatan Glagah Kabupaten Banyuwangi)", and Butar-Butar, Sibarani, Setia, and Widayawati reseach (2017) entitled "Preservation of Lake Toba Ecosystem through Batak Toba Folklore: Ecolinguistic Study". Those research mostly concern about myth and ecological preservation, one explained about myth's functions that support present research, and others about myth's power that work thoroughly in ecological preservation, but those have not mentioned yet about possibility of myth's power lack as present research's concern.

II. LITERATURE REVIEW

Ecology and environment's preservation issue is questioned for long time until now and the topic can be anything related to preservation itself. Although it is quite new, some research about myth and ecology have been

conducted. Firstly, Eidinow's research (2016) entitled "Telling stories: Exploring the Relationship between Myths and Ecological Wisdom" that proposes Myth as ecological wisdom's repositories and contends that theoretical and actionable wisdom within myth. Researcher also analyses myths and indigenous knowledge system's relationship that lead to thought about ecological futures. By understanding both relationships, be assumed that researcher can create new myth for sure with integrated knowledge systems. This research is considered as cognitive research to explain myth's socio-cultural. Comparing to that research, present research has similar concern that is myth and ecology. The present research focuses on myths' power toward Environmental preservation in Bali and have not conducted further yet to creating new myth as previous research did.

Secondly, Iswidayanti's research (2007) entitled "Fungsi Mitos dalam Kehidupan Sosial Budaya Masyarakat Pendukungnya (The Function of Myth in Social Cultural Life of Its Supporting Community)" concerns about myths' function in social-culture that be convinced can support the society. There are three functions mentioned: to explain meaningful symbols particularly in explaining environmental phenomena around them, to be principle maintaining social life among communities, and to be effective education media aiming to embed cultural values, social norms, and certain beliefs. Iswidayanti also stated that myth is considered as transformative one, not surprisingly, myth be exist in modern era someways. Research about myth's functions strengthens present research's argument about how powerful myth should be.

Thirdly, Sufia et al.'s research (2016) entitled "Kearifan Lokal dalam Melestarikan Lingkungan Hidup (Studi Kasus Masyarakat Adat Desa Kemiren Kecamatan Glagah Kabupaten Banyuwangi)" concerns about local wisdom in Kemiren village, Banyuwangi and its role to preserve environment. Sumarmi and Amirudin (2014) define local wisdom as indigenous knowledge that use to hold on life come together with belief system, norm, culture that be expressed in tradition and myth's embrace. The researcher found that communities' life in Kemiren Village are in harmony, unconsciously, their beliefs about Buyut Cili have a role in environmental preservation covers water resources, field, and rice field.

Actually, research about myth can be discussed through some disciplines such as discourse, semiotics, structuralism, anthropology, and ethnography, but this research aims to link linguistics (in this case, utterances about myth as data) and ecology so that this research is analysed with ecolinguistics. Fourthly, Butar-Butar et al. (2017) on their scientific article entitled "Preservation of Lake Toba Ecosystem through Batak Toba Folklore: Ecolinguistic Study" discussed about Batak Toba Folklore is functioned as support system in Lake Toba's preservation. They also took some points asserting Myth has a role in preservation such as Myth in culture context, myth as education media, and myth stimulates new creation and idea. Their research was conducted in Samosir Island and the locals become their respondents. Collecting data by interview and record on videotape, technically conduct by snowball technique while interpretation technique is used in analysing data. The results of their research are some folklore are known containing message covers advice, prohibition, injunction,

and solicitation. It can be inferred that value in those folklore relating to preservation aim. That research accords with this research especially talking about preservation through myth, folklore or other narratives. Different from their research, this research specifically use three dimensionality of Social Praxis in Ecolinguistics.

III. METHODOLOGY

A. Participants

This research used depth interview in collecting data (Black & Champion, 1992). Besides, personal experience method (Denzin & Champion, 1992) is also used. Probing technique is used in collecting the data in order to dig more information by questioning and clarifying the info to informants. Personal experience method is needed because this method makes informants easier to tell stories and their experience that can reinforce data value. Their words use, utterance, or maybe metaphor use also show their interaction frequency to environment. As Voloshinov said about word as Ideological vessel accompanied by self-awareness that is words' internalisation as sign network that keep forming definition and understanding (Takwin, 2003). Recorder is instrument that used to collect data and it is supported by note-taking technique. Purposive sampling technique is used to select the informants in accordance with the research's aim. In presenting data, descriptive method and deductive technique are used in this research. As mention before, myth is one of interesting topic and also close to people's lives especially in Bali that is known with rite, culture, and spiritual.

The three dimensionality of the Social Praxis that is proposed by Bang and Døør can be considered as theoretical frame of understanding and explaining the environmental constitution of language (as cited in Lindø & Bundsgaard, 2000). Those dimensions are ideological dimension, sociological dimension, and biological dimension. Bang and Døør (1998) stated that three logical dimensions are interrelated historical and dynamic system of recurrent pattern and tendencies; in another words those dimensions are not only supportive factors but also important things that entangled in explaining the environmental constitution of language. The sociological dimension, the one dimension of the three logical dimensions, is the way in which the speech community regulates their interrelation to maintain individual collectivity, whether the individuals know each other, familiar interaction, or strangers each other even with something happening around them (Lindo & Bundasgaard, 2003). Another dimension is the biological dimension, this dimension is about our biological collectivity and our relationship with other species (animals, plants, soils, oceans, microorganisms, macro-organisms, etc) (Lindo & Bundasgaard, 2003). The last dimension is ideological dimension; relates to mental collective, individual cognitive, physic and ideology systems (Lindø & Bundasgaard, 2003).

IV. FINDINGS AND DISCUSSION

This analysis is started with utterances' informants about myths in Bali. These myths are known most Balinese people.

There are many myths widespread especially relating to rite and culture but this research focuses on myth that engage with ecology, explain as below.

Ten dados ngaté uyut di peken, sekebesik beblanjaan ilang, jemak wong samar (1)

Tidak boleh membuat keributan di pasar, satu persatu barang belanjaan hilang diambil makhluk halus

It should not make a noise in the market, some buyers bought goods and losing them one by one because of spirits' entanglement

That is one of myth found in Bali about occurrences in market that is believed there is spirits' entanglement. They believed that some spirits like taking buyers' goods while buyers get into arguments so that they avoid conflict despite of feeling upset in market. Sociologically, that utterance showed that people's fear that occur because they believe towards myth benefited for maintaining their relationship among human. The myth has power to impact people's attitude by their fear. They think that is good for their own. Ideologically, people believe God does not just create people but also others include spirits that can live together in one environment. So that, people believe all of God's creation can be harmonious if there is no trigger to cause bad things. As Sufia et al.'s research (2016) that found Kemiren Village, Banyuwangi is in harmony because people there hold on local wisdom, do the tradition, and be obedient on myth and prohibitions in their community. However, that fear comes from their intentions to protect their own, more than that there is more important things; that is environment. Ecology is not about environment but also interaction among organisms and physical surrounding that also affect by people's behaviour. For this phenomena, myth is powerful because that myth concerning about human and their loss. In line with Iswidayati's research (2007), this myth functioned to explain phenomena around them and loss incident as a meaningful symbol so that people can remind each other to well-behaved there. Besides, that myth also functioned as norm to maintain social relationship among people. Eidinow (2016) also mentioned about myth comprises actionable wisdom that lead people's process to think about ecological future, and their socio-cultural life.

Yén ngeliwatin punyan bingin, ingetang nge-bél, nyelang margi pang slamet (2)

Jika melewati jalan yang ada pohon beringin, ingat klakson, permisi agar selamat

If you pass banyan tree on street, do not forget honking to ask permission

Banyan tree has strong scary impression because of its appearance. Its big trunk and large leaf make area around it become dark so that that scary impression get stronger. Balinese people believed that each banyan tree is dwelled by spirits, they also cover banyan tree with poleng cloth (chequered cloth) as a sign. Balinese people also make and give offering there to harmonize the environment. Therefore, each rider or driver pass banyan tree on the street

never forget honk vehicle's horn to ask permission to banyan tree dwellers. Sociologically, that phenomena has benefit to take care each other because dark road, lack of lights and are planted many trees are risky for riders or drivers and also pedestrians. Honking the horn can warn other rider or driver so that they can decelerate and avoid accident. The existence of that myth also benefited the banyan tree itself. People think many times to cut off the banyan tree, they are afraid something bad will happen. Moreover, functionally banyan tree's roots hold ground firmly preventing landslide and absorb water from the ground. So environment is maintained and people around them are still safe. However, the myth can be considered as powerless relating to people's habit particularly dumping garbage to the river or around banyan tree. Banyan tree commonly grow near the river in Bali. Bali is not just facing threat from pressure of mass tourism but also people's bad habit that can destruct beauty of Bali.

There is certain research about film assumes that spectator accept messages about ecology sustainability from film, repository culture memory, and increase their awareness as the result of engaging with ecosophy. The banyan tree myth is supposed to be similar with that case but not, in fact. People still dump garbage near banyan tree, to the river. They believed that banyan tree's dwellers are exist but they still lack of awareness about protecting environment. This finding is different to some mentioned research. Eidinow's research (2016) stated that relationship myth and indigenous knowledge system can lead to powerful process to think about ecological future. It is reasonable if different case relating to banyan tree myth happened where people believed in myth but cannot break bad habit to environment that possibly caused by inadequate sense of belonging. Iswidayanti (2007) found that myth can be functioned as education facility and banyan tree myth potent in embedding social norm and value leading people more thoughtful about ecological preservation.

Sube biasa blabar, taen blabar agung nganti ngliwatin duur jembatan niki, yen nak ngorang wenten petapan lipi anyud (3)

Banjir itu sudah biasa, pernah sebelumnya banjir besar sampai melewati atas jembatan ini, orang lain bilang ada pertapa ular hanyut

Flood happens frequently here, previously, there was big flood pass over the bridge, and people said there was snake ascetic (mythical creature) floating off.

The informants live near Tukad Badung (Badung river) for many years. That Place is considered as place more frequent to flooding; is a serious concern but Balinese people who live near the river think that is common occurrence because it happened several times. Moreover, there is myth heard in that story. They believed that there is mythical creature snake-like that become ascetic is brought by big flood and float over the bridge. Ideologically, they believed God and the manifestation and also some mythical creatures are exist so that people give offering, make rite, and increase their spiritual relationship with God to ask protection from God by harmonizing relationship among God, human, animals, plants, and ecology. However, they

ignore the fact that flood occurs because of excessive rain, a rupture dam, and waste disposal that obstruct water absorption. This myth also can be concluded lack of power because its function to affect people's cognitive cannot increase their awareness in protecting environment. It contradicts to Iswidayanti's research (2007) that found one of myth's function is explaining environmental phenomena through meaningful symbols, because that myth is known but misinterpreted. Different to Butar Butar et al.'s research (2017) and Sufia et al.'s research (2016) that claim myth play a role in preservation, Myth (3) treats as acceptance so that, people who live near Tukad Badung view some incidents like big flood as common occurrence. That misinterpretation cannot lead powerful process to think about ecological futures as Edinow's research (2016).

Balinese people also have myth about sea, about Varuna: God of Water, and also about Ratu Pantai Selatan: Goddess of the Sea. Balinese elders usually prohibit their children or family wearing red colored outfit to the sea because they believed that Goddess of the sea will keen on and catch them by dragging out them to sea. The similar myth can also be found in Java but the prohibition is related to anything green. We realized that cultures as social aspect of society so that myth and local wisdoms are rich in Indonesia as many as cultures that live and grow with society itself. Unfortunately, myth affect differently to each person's behavior relating to environment's preservation. Myth is powerful relating to human's protection but still lack of power engaging with environment protection. As we see and experience, many people still throw food waste to the sea without thinking about serious damage for environment. They are not just float up in the sea but also are eaten by sea creatures. As Keraf (2014) stated, one of Crisis and Environmental disaster's root is mechanistic paradigm in modern science that be model and dominant. Finding out new perspective about universe is also mention to overcome crisis and environmental matters. We are demanded understanding universe as life system through that perspective. Systemic, organismic, holistic, and ecological elements are contained in that perspective (Keraf, 2014, p. 70). So we can say that starting by having new paradigm, awareness and common sense play a role, mental process happens, then people consciously act for environmental preservation and myth be powerful thoroughly because it reinforces their action.

V. CONCLUSION

The implementation of e-learning provides unique advantages to education, not to mention in the area of English teaching in higher education. The massive adoption of e-learning and paradigm shift from traditional to online learning are without challenges. This current study has attempted to explore the challenges facing students of an English Education Department of a private university in Yogyakarta in implementing e-learning and investigating their strategies to overcome the challenges. Five lecturers were interviewed to gather the data. 20 students were recruited to be involved in the focus group discussion. In addition to interview and FGD, documents related to the implementation of e-learning were analyzed.

The study revealed that several challenges were faced by students in implementing e-learning including cognitive,

metacognitive, computer anxiety and learning styles challenges. The strategies used to overcome the cognitive challenges consisted of training in using the e-learning functions as well as selection and comprehension of the information. The strategies to overcome the metacognitive challenges were goal setting, self-management, time management, effort regulation and self-evaluation strategies. The strategies to overcome the computer anxiety challenges included the self-monitoring strategy for checking the e-learning submission and the provision of data back up to anticipate the data loss while the strategies to overcome the learning styles was the adoption of video conference and synchronous online discussion.

The implications of this study are related to both students and lecturers. This current study has revealed the types of challenges and strategies concerning the implementation of e-learning. However, the major concern of the students is that to a certain degree, they have more preference on the discussion conducted in face-to face classroom. This concern should become lecturers' awareness that the shift from offline learning to online learning is not only a matter of using internet technology, but also cultivating the student-centered learning. Hence, e-learning should be created in an interesting and dynamic learning atmosphere so that students' learning will be effective. As in the traditional classroom, lecturers should be facilitators who assist with students' difficulty and give useful feedback to their learning.

REFERENCES

- Ahimsa P., & Heddy S. (2001). *Strukturalisme Levi-Strauss, mitos dan karya sastra*. Yogyakarta: Galang Press.
- Bang, J. C., & Døør, J. (1998). *Sprogteori I X*. Odense: Nordisk Institut.
- Black, J. A., Champion, D. J., Koeswara, E., Salam, D., & Ruzhendi, A. (1992). *Metode dan masalah penelitian sosial*. Bandung: PT Eresco.
- Butar-Butar, C., Sibarani, R., Setia, E., & Widayawati, D. (2017). Preservation of lake Toba ecosystem through Batak Toba folklore. *Ecolinguistic Study*, 5, 65–75.
- Casson, R. W. (1981). *Language, culture, and cognition*. New York: Mcmillan USA.
- Daeng, H. (2000). *Manusia, kebudayaan, dan lingkungan tinjauan antropologis*. Yogyakarta: Pustaka Pelajar.
- Denzin, N., & Lincoln Y. (Eds.). (2000). *Handbook of qualitative research*. Yogyakarta: Pustaka Pelajar.
- Eidinow, E. (2016). Telling stories: Exploring the relationship between myths and ecological wisdoms. *Landscape and Urban Planning Journal*, 2016, 155, 47–52.
- Fill, A., & Mühlhäusler, P. (2006). *The Ecolinguistics reader: Language, ecology, and environment*. London: Continuum.
- Iswidayanti, S. (2007). Fungsi mitos dalam kehidupan sosial budaya masyarakat pendukungnya. *Harmonia: Jurnal Pengetahuan dan Pemikiran Seni*, 8(2), 180–184.

- Itu, M. (2010). "The Hermeneutics of Myth". In the 11th *International Conference of ISSEI*, 19(11), 32-37.
- Keraf, S. (2014). *Filsafat ekologi hidup, alam sebagai sebuah sistem kehidupan (bersama Fritjof Capra)*. Yogyakarta: Kanisius.
- Lindø, A. V., & Bundsgaard, J. (2000). *Dialectical ecolinguistics three essays for the symposium 30 years of language and ecology in Graz December 2000*. Odense: Research Group for Ecology, Language & Ideology, Odense University.
- Mbete, A. M. (2014). "Bahasa dan Diskursus Kekuasaan dalam Cultural Studies" dalam *Seminar Budaya Politik Menyongsong Pemilu 2014 yang berperadaban*. Kendari: Universitas Halu Oleo.
- Sufia, R., Sumarmi, & Amirudin, A. (2016). Kearifan lokal dalam melestarikan lingkungan hidup (Studi kasus masyarakat adat desa Kemiren kecamatan Glagah kabupaten Banyuwangi). *Jurnal Pendidikan*. 1(4). 726–731.
- Takwin, B. (2003). *Akar-Akar Ideologi*. Yogyakarta: Jalasutra.

The First Language Interference in Producing English Consonant Sounds

Kuntum Palupi Setyaningsih
Universitas Sebelas Maret

Surakarta, Indonesia
Kuntumpalupi10@student.uns.ac.id

Agus Wijayanto
Universitas Sebelas Maret,

Surakarta, Indonesia
aguswijayanto@ums.ac.id

Suparno

Universitas Sebelas Maret
Surakarta, Indonesia

drs.suparno@rocketmail.com

Abstract—This research deals with the problems encountered by the students whose first language is Sundanese language in learning English as a Foreign Language. The focus of this study is to examine the errors made by the students who have a Sundanese cultural background in producing consonant sounds. The study used descriptive qualitative research. This study involved the first-grade students of Vocational High School. The data were collected through observations and recordings. The recording of the students' English pronunciation was transcribed phonetically. The data were analyzed by using contrastive analysis techniques. The findings revealed that Sundanese students met problems in English consonant sounds while producing, [ð], [v], [f], and sounds. Sundanese students tend to shift the English consonant sounds to Sundanese sound systems when they speak. The results indicate that the significant differences between English and Sundanese sound systems are the cause of interference. To reduce the first language interference, the teacher should learn something about phonetic features of the students' first language sound systems so she or he can predict the errors that students would probably make while producing English sounds. Moreover, the students must be familiarized to speak and to listen to English in the teaching-learning process.

Keywords— first language, interference, Sundanese language, English Pronunciation, Consonant sounds

I. INTRODUCTION

Indonesia has numerous ethnic groups with different background of native language that people use as a tool for daily communication. Unfortunately, the opportunity to speak English for the students in Indonesia become lesser because it is only thought as a foreign language which means that it is only be practiced in school even only in English class. The numbers of native English speakers that are not many in the students' environment make the challenge higher for the students (Tantra, 2015). The students will not be accustomed to speaking English. Furthermore, the speaking practice in the class among the students and the teacher become lesser because they often add their first language while speaking English. The teacher can't control this situation because it will be challenging to

decrease the students' habits in using their mother tongue. Unconsciously the students' way of speaking is affected by the practices of using their first language, especially in pronouncing English words. Dhillon (2016) conveys that the students' first language affects their pronunciation.

Some experts have investigated related to first language interference. The students of Sudan University who speak Sundanese Spoken Arabic as their first language experienced from first language interference. Hassan (2014) revealed that these students met problems in pronouncing English consonants namely [z] and [ð], [s] and [θ], [b] and [p], [j] and [tj]. Moreover, Dhillon (2016) found out that the students of Nommensen HKBP University with Batak Toba as their first language met the difficulties in pronouncing English phonemes such as vowels [ə], and [ɜ]. The third expert is Mu'in (2017), he proved that the students of Lambung Mangkurat University found that learning English pronunciation is a difficult matter. The students made errors in speech sounds [i:] and [ɪ]. This is because of their habit in using local language (Banjarese) is said to be strong.

This research aims to investigate the interference of the first language in pronouncing English sounds for the students with a Sundanese background. Sundanese use basa Sunda as their first language. There are some differences in the sound systems between English and Sundanese. Some English sounds are not available in Sundanese sounds. Thus it makes a bit difficult for them in pronouncing some English words. Brown (1994) proposes that the differences in the sound systems between the students' first language and target language cause difficulty in learning pronunciation. The Sundanese students usually mispronounced some English sounds, e.g., consonant sound [z]. The students even changed the English sound [z] into [s] sound. For example, the word present /'preznt/ they pronounced it as /'presnt/. Besides, in asserting [z] sound especially in mentioning someone's name with the first letter of [z] sound, they change it into [j] sound, e.g., Zaria □ Jaria. The errors in pronunciation that were made by the students with the Sundanese background may not be beneficial for them to build excellent communication in society. Furthermore, this research is limited to the interference of the first language in producing English consonant sounds [f], [v], [θ], [ð], and [z] made by Sundanese students in learning English.

II. LITERATURE REVIEW

A. Pronunciation

Pronunciation takes an essential side in our social lives because our identity and our communities can be reflected from the way we speak (Seidlhofer, 2001 as cited from Shak, 2016). Moreover, as the development of English language on its status as a universal tool of communication, people grow their thoughts to not only understand what people convey in English but also they have to be able to produce their speech through English.

Cook as cited in Gilakjani (2016), defines pronunciation as the creation of English sounds. According to Burgess and Spencer as mentioned in Susanna (2015) pronunciation in language learning refers to the use of phonological knowledge of the target language and the interpretation of that. Generally, the students of EFL encounter some difficulties in learning pronunciation. They frequently produce the wrong English sounds that make the listeners may have a different interpretation. Moreover, building excellent communication may not be achieved. Brown (1994) states that the factors that cause the problems for the students in pronunciation are the differences between their phonological system of native language and their target language. There are many students of EFL still cope with mispronouncing English sounds. They tend to shift the English sounds. Dhillon (2016) explains that their local language may influence the way the students in pronouncing an English word. This case is called interference.

B. First Language Interference

According to Baloch (2013) a child acquires her/his mother tongue as the main language and uses it for communication needs and desires. A child begins to acquire his/her mother tongue since his/her birth. People around him/her communicate with her/him by using the same mother tongue. Cognitively, it carved on her/his mind. Furthermore, first language interference is the insertion of the learners' knowledge of their first language in the process of acquiring the target language (Subandowo, 2017). Lekova (2010) defines the concept of interference as the case when the learners make mistakes in spoken or written while learning a foreign language by transferring language habits from native to the foreign language meanwhile, they ignore the rules of foreign language speakers.

First, language interference considered as a language transfer effect that is divided into positive interference and negative interference. Baloch (2013) enlightens that positive interference occurs when the structures of both first language and target language are the same, and the learners are able to produce the target language correctly. Conversely, negative interference is the application of different structure of the first language that is applied in the process of acquiring the target language (Baloch, 2013). Furthermore, the case of the students' mispronunciation is the most common types of interference of mother tongue in learning the target language (Manrique, 2013). The phenomena of interference might arise in some linguistic areas, namely phonemics/phonology, morphology, semantics, and syntax. This study is limited in the field of phonemic interference. The local language of Sundanese students, basa Sunda, caused interference in the process of learning English.

C. English Sound Systems

1) Vowels

According to Fromkin, Rodman, and Hyams (2017), vowels are produced with little restriction of the airflow from the lungs out through the mouth and the nose.

2) Diphthongs

According to Fromkin et al. (2017), a diphthong is a sequence of two vowels sounds bonded together. The English diphthongs in English are the vowel sound in the word bite, the vowel sound in bout, the vowel sound in Freud, and the vowel sounds in the word reign (Fromkin et al., 2017).

3) Consonants

According to Fromkin et al. (2017), consonants are produced with some restriction or closure in the vocal tract that impedes the flow of air from the lungs (p. 189). There are 24 consonant and 14 vowel sounds in English (Fromkin et al., 2017). Here is the table of consonant and vowel sounds in English:

TABLE I

Consonants				Vowels					
p	pill	t	till	k	kill	i	beet	ɪ	bit
b	bill	d	dill	g	gill	e	bait	ɛ	bet
m	mill	n	nil	ŋ	ring	u	boot	ʊ	foot
f	feel	s	seal	h	heal	o	boat	ɔ	bore
v	veal	z	zeal	l	leaf	æ	bat	a	pot/bar
θ	thigh	tʃ	chill	r	reef	ʌ	butt	ə	sofa
ð	thy	dʒ	gin	j	you	aɪ	bite	aʊ	bout
ʃ	shill	m	which	w	witch	ɔɪ	boy		
ʒ	measure								

D. Phonemic System of Sundanese Language

Generally, Tamsyah (2010) classifies Sundanese sound systems into vowel sounds (*aksara swara*), consonant sounds (*aksara konsonan*), and *engang*.

1) Vowel Sounds (*aksara swara*)

According to Tamsyah (2010) vowel sounds are sounds that make the sound of the lungs coming out through the throat that are not blocked by speech instruments such as lips, teeth, tongue, and ceiling (p.15). Here are the examples of the words with vowel sounds in Sundanese :

- a) Vowel [a] in a word *amprok* (meet).
- b) Vowel [i] in a word *indit* (go)
- c) Vowel [u] in a word *ulin* (play)
- d) Vowel [é] in a word *saé* (good)
- e) Vowel [o] in a word *hejo* (green)
- f) Vowel [e] in a word *siem* (gourd)
- g) Vowel [eu] in a word *eunteup* (go down)

2) Consonant sounds (*aksara konsonan*)

According to Tamsyah (2010), consonant sounds are sounds that are coming out through the throat blocked by

speech instruments (p.17). Here are the examples of consonant sounds in Sundanese:

- a) Sound [p] in a word *handap* (bottom)
- b) Sound [b] in a word *loba* (many)
- c) Sound [m] in a word *mitoha* (mother in law)
- d) Sound [w] in a word *rawayan* (bridge)
- e) Sound [d] in a word *babad* (history)
- f) Sound [l] in a word *lila* (take a long time)
- g) Sound [n] in a word *nagara* (country)
- h) Sound [r] in a word *baraya* (family)
- i) Sound [s] in a word *basa* (language)
- j) Sound [t] in a word *peuting* (night)
- k) Sound [c] in a word *cau* (banana)
- l) Sound [j] in a word *jidar* (ruller)
- m) Sound [ny] in a word *manyun* (pout)
- n) Sound [y] in a word *rawayan* (bridge)
- o) Sound [k] in a word *angkeut* (chin)
- p) Sound [g] in a word *dagé* (traditional food)
- q) Sound [ng] in a word *soang* (goose)
- r) Sound [h] in a word *hade* (want)

E. The Possibilities of Interference

It has been clearly explained that the English sound systems are much various than Sundanese sound systems. Furthermore, it is possible that interference of mother tongue of Sundanese students occurs in the process of learning English. The researcher supposed that Sundanese students will meet the difficulties in pronouncing English sounds.

The possibilities of mother tongue interference of Sundanese students are:

- 1) Consonants [f] in a word five /faɪv/ and [v] vanilla /və'ni:lə/. The students may change the consonants into [p] sound like in a word pamajikan (wife).
- 2) Consonant [θ] in a word nothing /'nʌθɪŋ/ may be changed into [t] sound like in a word butut (bad).
- 3) Consonant [ð] in a word they /ðeɪ/ may be changed into sound [d] like in a word damang (good).
- 4) Consonant [z] in a word xenophobe /'zenəfəʊb/ may be changed into [s] sound like in a word mios (go).
- 5) Consonant [ʃ] in a word sure /ʃʊə/ may be changed into [s] sound like in a word sieun (scared).
- 6) Consonant [ʒ] in a word treasure /'treɪzə/ may be changed into [s] like in a word seuri (laugh).
- 7) Consonant [tʃ] in a word cheers /tʃiəz/ may be changed into [c] sound like in a word cau (water).
- 8) Consonant [dʒ] in a word gentle /'dʒent(ə)l/ may be changed into [j] sound like in a word jurig (ghost).

According to the explanation above, the students with the Sundanese background are supposed to interfere with producing English sounds. The difficulties in pronouncing English sounds may take place because of the different phonemic system between English and Sundanese.

III. METHODOLOGY

The methodology of this research was a descriptive qualitative method. Maxwell (2005) states "Qualitative study is the activities of collecting and analyzing data, developing and modifying theory, elaborating or refocusing the research questions, and also identifying and eliminating validity threats are usually all going on more or less simultaneously, each influencing all of the others" (p. 3). The case study enables the researcher to explore the data within a specific context. A case study examines and investigates the phenomenon in a real-life through detail contextual analysis of a limited number of events or conditions, and relationships (Zainal, 2007). Different from quantitative research which observes in macro data level, case studies see the data at the micro-level. This research investigated the students with a Sundanese background who suffered from first language interference. This study was focused on phonological approach, which analyzed the English consonants sounds that were mispronounced by the Sundanese learners. However, this study is descriptive qualitative research. The goal of this study is to explain an occurrence and its characteristics. Nassaji (2015) describes that the descriptive research refers to what something happen rather than how or why. This study is included as a descriptive qualitative because it deals with the natural phenomenon of the learners' pronunciation.

The sample of this research is 30 students of Vocational High School in Majenang, Cilacap, whose first language is Sundanese. The data collection technique was obtained by asking the students to read English texts. The texts were designed with the consideration in the possibilities of mother tongue interference in some phonemes which are not available in Sundanese. An audio recording was used to take the students' pronunciation. Hassan (2014) used audio recording as a tool for data collection. The students' audio recording can be repeated as many as possible to identify the mispronouncing made by the students with a Sundanese background. The data was analyzed by collecting the mispronounced words formed by the students. Then, the analysis of phonemic interference was used contrastive analysis. It means that the researcher compares the Sundanese phonemic systems to English.

In order to assure the quality of the research, trustworthiness was conducted in this study. Triangulation technique was used in this study. Wilson (2014) argues that triangulation is used with the purpose to enrich the data and to confirm the results of the research. Moreover, investigation triangulation was used in this study. Denzin (1970) claims that investigation triangulation needs more than one observer, interviewer, or analyst in the research. Thus, in 2015, He conveys that the same results will not appear precisely if two investigators do the research. The intention of using investigator triangulation is to avoid the bias data from each researcher.

IV. FINDINGS AND DISCUSSION

The data of this research were English words that had been uttered inaccurately. The data were gathered through recording during the students' activity in reading aloud. The data collections were assembled as follows:

1. The students changed consonant sound [f] with [p].
Examples:

TABLE 2

English Words	Phonetics Transcription	Students' Pronunciation
Iphone	/ 'aɪ fəʊn /	/aipon/
Photo	/ 'fəʊtəʊ /	/poto/
Saxophone	/ 'sæksəfəʊn /	/sakopon/
Photograph	/ 'fəʊtəgrɑ:f /	/potograpi/
Xelophone	/ 'seləʊfeɪn /	/kelopane/
Elephant	/ 'elɪfənt /	/elepan/
Joseph	/ 'dʒəʊzɪf /	/josep/
Laugh	/ lɑ:f /	/laug/
Coughing	/ 'kɒfɪŋ /	/coging/

- A. The students changed consonant sound [v] with [f].
Examples:

TABLE 3

English Words	Phonetics Transcription	Students' Pronunciation
Very	/ 'veri /	/feri/
Movie	/ 'mu:vi /	/mofi/
Vacation	/və'keɪʃən/	/fekesyen/
Voice	/ vɔɪs /	/fois/
Whenever	/ wen'evə /	/whenefer/
Forgive	/ fə'grɪv /	/forgif/
Leftover	/ 'left'əʊvə /	/lefofer/

- B. The students changed consonant sound [θ] with [t].
Examples:

TABLE 4

English Words	Phonetics Transcription	Students' Pronunciation
Both	/ bæʊθ /	/bot/
heatre	/ 'θɪətə /	/teter/
through	/ θru: /	/trogh/
things	/ θɪŋz /	/thigs/
Birthday	/ 'bɜ:θdeɪ /	/birt dai/

- C. The students changed consonant sound [ð] with [d] or [t].
Examples:

TABLE 5

English Words	Phonetics Transcription	Students' Pronunciation
The	/ ðə /	/the/
There	/ ðeə /	/dere/
Then	/ ðen /	/den/
They	/ ðeɪ /	/dei/
With	/ wɪð /	/wit/
That	/ ðæt /	/tet/
Them	/ ðem /	/tem/
Those	/ ðəʊz /	/dos/

- D. The students changed consonant sound [z] with [j] or [s].

Examples:

TABLE 6

English Words	Phonetics Transcription	Students' Pronunciation
Zander	/ 'zændə /	/jander/
Pretzels	/ pretzelz /	/pretjel/
His	/ hɪz /	/his/
Was	/ wɒz /	/wes/
Present	/ 'preznt /	/presen/
Raspberry	/ 'rɑ:zbəri /	/rasberi/
Beans	/ bi:nz /	/bins/
Tacos	/ 'tækəʊz /	/tacos/
Raisins	/ reɪnz /	/raisin/

According to the collected data from the interference of mother tongue that was occurred among Sundanese students in learning English, these were being described as follows:

- A. The interference of mother tongue for the students with a Sundanese background in the phoneme [f]. Practically, the students have a tendency to shift the sound [f] with [p]. The shifting happened because there is not available [f] sound on their mother tongue. The [p] sound was used to change the [f] since sound [p] has the closest sound with [f] sound.
- B. The interference of mother tongue occurred for the students with a Sundanese background in pronouncing [v] sound. The students tend to change the sound [v] with the sound [f]. The mispronouncing of the sound [v] happened among Sundanese students due to the non-existing phoneme [v] in their sound systems, *basa Sunda*. The influence of mother tongue interference with a Sundanese background of the students may change the meaning of the words that they had uttered. For example, the word *lives* → /lɪvz/, the students pronounced it as /lɪfs/.
- C. The interference of mother tongue occurred for the students with a Sundanese background in pronouncing [θ] sound. The students tend to shift the sound [θ] with [t] sound as they were familiar with the sound. They have tendency to shift the words that include [θ] sound with [t] sound whether the words are placed in front, middle, or final. For example, the sound [θ] in the word *birthday* → /'bɜ:θdeɪ/ they uttered it as /bert dai/.
- D. The interference of mother tongue occurred for the students with a Sundanese background in pronouncing [ð] sound. The students have the tendency to shift the sound [ð] with [d] or [t]. For example, the word *they* → /ðeɪ/, the students pronounced it as /dei/. It is understandable for the fact that the students with Sundanese background tend to change the sound because, in the Sundanese sound systems, sound [ð] is not available.
- E. The interference of mother tongue occurred for the students with a Sundanese background in pronouncing [z] sound. The students tend to shift the sound [z] with [s] sound. This case happened because the students change the sound into the familiar sound in their sound

system, which is [s] sound. For example, the word *present* → /'preznt / they read it as /presen/.

Ladefoged as cited in Hassan (2014) conveys that mother tongue gives apparent influence on learning the target language. In this, a Sundanese environment which surrounds the students' daily life influences the students' way in uttering English sounds. The students will use their mother tongue frequently, even in the English classroom. Wei in Demirezen and Kulaksiz (2015) defines that the phonological fossilization is the repetition of phonological errors that are caused from the incorrect acquisition of pronunciation of target language, usually affected by the first language. Thus, whether the students are aware or not, the way they pronounce English sounds will be affected by their mother tongue, in this case, is Sundanese. The amount of usage of mother tongue will affect the students' ability in uttering English sounds. Kosasih (2017) states that mispronouncing English sounds will cause problems in pronunciation. The message may not be sent well, the listeners may have different interpretation about the delivered message, and excellent communication may not be achieved by the students, especially the students with a Sundanese background.

Moreover, the needs of speaking English in Indonesia is only be used as a foreign language, which means the students may speak English only in English class. English is not being practiced in daily life as a communication tool. Preferably it is used as the curriculum demanding. Another factor that possible to bring interference of mother tongue among Sundanese students is the ability of the teacher to control the students' habit in using Sundanese while learning English. They tend to insert Sundanese language while they have to speak in English. So the students can't be accustomed to talk to English. Hassan (2014) explains that the over the practice of the mother tongue affect the mispronunciation in English phonemes. Practically, it is tough to avoid the use of the mother tongue that it has become fossilization for the students.

V. CONCLUSION

A. Conclusions

The The findings of this research can be drawn as follows:

- 1) The interference of mother tongue of Sundanese students in learning English made the students difficulty in uttering some English phonemes, especially in consonant sounds.
- 2) The problems of students pronunciation are in the consonant sounds [f], [v], [θ], [ð], and [z].
- 3) All the English phonemes that were mispronounced by the Sundanese students are not available in their language systems.

B. Recommendations

The researcher suggests the following points to be sidered:

- 1) For Teacher

Related to the English phonemes and stress materials should be delivered by the teacher to the students clearly. Phonological knowledge will help the students become more aware in the English sound systems which have different sound systems with their first language. Thus, the teacher should be able to give correct pronunciation of English words and to repeat the words with correct stressed, to help the students in imitating the correct English pronunciation.

2) For Other Researchers

The researcher supposes the other researchers to explore the students' difficulties in uttering English words, especially for the students who learn English as a Foreign Language with different native language. The results may contribute the other researcher in linguistics area, namely it offers information about the influence of the first language in students' pronunciation ability.

REFERENCES

- Baloch, S. S. (2013). L1 (Arabic) interference in learning L2 (English): An analysis of English spelling used by Arabic speakers at undergraduate level. *European Scientific Journal*, 9(16), 226-232.
- Brown, D. (1994). *Teaching by Principles: An interactive approach to language pedagogy* (2nd ed.). New Jersey: Prentice Hall.
- Denzin, N. K. (1970). *The research act: A theoretical introduction to sociological methods*. Chicago: Aldine.
- Denzin, N. K. (2015). Triangulation. *The Blackwell Encyclopedia of Sociology*. doi:10.1002/9781405165518.wbeost050
- Demirezen, M; Kulaksiz, E. (2015). Fossilized pronunciation errors from the perspectives of Turkish teachers of English and their implications. *Procedia Social and Behavioral Sciences*. 199, 793-800.
- Dhillon, B. P. S., (2016). Does Mother Tongue Affect the English Pronunciation?. *International Conference on Language, Education, Humanities and Innovation*, 4(4).
- Fromkin, V., Rodman, R., & Hyams, N. (2017). *An introduction to language* (11th ed). Boston: Thomson.
- Gilakjani, A (2016). "English pronunciation instruction: Views and recommendations." *International Journal of Research in English Education*. 1(1).
- Hassan, E. M. I. (2014). Pronunciation problems: A case study of English language students at Sudan University of Science and Technology. *English Language and Literature Studies*, 4(4).
- Kosasih, M. M. (2017). "Native Language Interference in Learning English Pronunciation: A Case Study at a Private University in West Java, Indonesia." *International Journal of Education and Research*, 4(2), 135-150.
- Lekova, B. (2010). Interference and methods of its overcoming in foreign language teaching. *Trakia Journal of Sciences*, 8(3), 320-324.

- Manrique, C. (2013). *Mother tongue interference with foreign language: A case study about A2 oral production in a Columbian public university*. Columbia: Columbian Public University.
- Maxwell, J. A. (2005). *Qualitative research design: An interactive approach* (2nd Ed.). Thousand Oaks, CA: SAGE Publications.
- Mu'in, F. (2017). Phonemic interference of local language in spoken English by students of English department of Lambung Mangkurat university. *Journal of Language aching and Research*, 8(1), 64-74.
- Nassaji, H. (2015). Qualitative and descriptive research: Data type versus data analysis. *Language Teaching Research*, 19, 129-132. doi:10.1177/1362168815572747
- Shak, P., Chang, S. L., and Stephen, J. (2016). "Pronunciation problems: A case study on English pronunciation errors of low proficient students," *The International Journal of Language Education and Applied Linguistics (IJLEAL)*, 4, 25-35.
- Subandowo, D. (2017). The language interference in English speaking ability for EFL learners. *International Seminar on English Language and Teaching*, 205–206. Retrieved from ejournal.unp.ac.id/index.php/selt/article/view/8005.
- Susanna, M. (2014). *A Study on Teaching English Pronunciation in Primary Schools in Italy*. Corso di Laurea Magistrale (ordinamento ex D.M. 270/2004 in Scienze del Linguaggio).
- Tamsyah, D. R. (2010). *Galuring Basa Sunda*. Bandung: CV. Pustaka Setia.
- Tantra, D. K. (2015). Teaching English as a foreign language in Indonesia: a literature review. *Lingual: Journal of Language and Culture*, 3(4).
- Wilson, V. (2014). Research methods: Triangulation. *Evidence Based Library and Information Practice*, 9, 74-75. Retrieved from <http://ejournals.library.ualberta.ca>.
- Zainal, Z., (2007). Case study as a research method. *Jurnal Kemanusiaan*, 9,1-6.

The First Language Interference in Producing English Consonant Sounds

Layla Kurniawati
Lecturer Public Administration
Institute of Home Affairs (IPDN)
Sumedang, Indonesia
laylatanto@gmail.com

Abstract—Peer teaching is a learning approach which is developed for developing student's English reading skill at IPDN. This research is designed to solve some problems in teaching English at three curriculum systems at IPDN, especially English teaching problems at parenting curriculum system. This research explores the concept of peer teaching approach which utilizes peers in the form of interaction among the same level students and also in the form of junior and senior students who are more knowledge of English. This research focus on the collaboration among students, lecturers, trainers and other staffs for solving English teaching problems at IPDN. The method is mix methods (qualitative-quantitative). The qualitative step is conducted by need analysis (the strength, weaknesses, opportunities and also the threat belong to IPDN). The data are collected in the forms of documents, observations and interviews. The offering teaching approach tested in limited and extensive group. The results show that the pre-test score has increase at post test score consecutively. from 51.78 when the pre-test became 59.55, the first post-test, 75.11 at the second post-test, and 81.33 at the 3rd post test, at limited and extensive test. The other results are the development of the students reading and speaking skills, the increase of student's interest of learning English, the embryo of learning community among the students, teachers, trainers, staffs of IPDN. The requirements for planning the activities before being applied to real classes are also a prerequisite for making learning in large classes applicable.

Keywords— Need Analysis, Peer teaching, Reading skill

I. INTRODUCTION

Administration Institute of Home Affairs (IPDN) is a higher Education under Ministry of Home Affairs. This institute has task to educate the cadre of civil servants and leaders who come from all Indonesia areas. As boarding school, IPDN has three curriculum systems (teaching curriculum, training and parenting). English as foreign language belongs to these three curriculum systems. The implementation of English teaching has so many problems, such as: a).The limitation of English lecturers; b). The English lesson do not connected each other at these three curriculum systems; c). The rule of teaching staffs indicates that they can't cross to each other curriculum. So it causes

some teaching learning problems in the parenting curriculum, especially lack of English teaching staffs at parenting curriculum.

Beside the limited number of English teaching staffs, the other problems are the student's desire for learning English haven't accommodated yet. The tight schedule of students' activities make the time for learning English at parenting curriculum to be constrained. The last problem is there is not standard formats for teaching program at parenting curriculum. These various problems encouraged researcher to conduct research activities to find the answer of the question, "what approach can be used to solve English teaching problems at parenting curriculum system?"

Public Administration Institute of Home Affairs (IPDN) is a higher Education under Ministry of Home Affairs. This institute has task to educate the cadre of civil servants and leaders who come from all Indonesia areas. As boarding school, IPDN has three curriculum systems (teaching curriculum, training and parenting). English as foreign language belongs to these three curriculum systems. The implementation of English teaching has so many problems, such as: a).The limitation of English lecturers; b). The English lesson do not connected each other at these three curriculum systems; c). The rule of teaching staffs indicates that they can not cross to each other curriculum. So it causes some teaching learning problems in the parenting curriculum, especially lack of English teaching staffs at parenting curriculum.

Beside the limited number of English teaching staffs, the other problems are the students desire for learning English haven't accommodated yet. The tight schedule of students' activities make the time for learning English at parenting curriculum to be constrained. The last problem is there is not standard formats for teaching program at parenting curriculum. These various problems encouraged researcher to conduct research activities to find the answer of the question, " what approach can be used to solve English teaching problems at parenting curriculum system?"

II. LITERATURE REVIEW

A. Need Analysis

Determining factors and aspects that are needed in improving the quality of learning in the class can be done by using needs analysis (a process that educational needs become a priority matter (Mc Neil, 2006, p. 97). The process of identifying the things that are needed to

encourage and improve the success of classroom learning process.

The concept of need analysis stated by Mc. Neil is a condition in which a discrepancy between learners achievement (attitude) and a condition where there is a gap between achievement (attitudes of students) that can be accepted and the students' conditions observed. Need analysis can be used to anticipate what needs are needed to minimize or even eliminate the gaps in the learning process.

The above opinion shows that need analysis is a process to see the main priorities of education. Identifying problems that arise in the educational process carried out by curriculum developers. As a process, need analysis also has roles and functions. The interpretation of need analysis as a process with various descriptions and interpretations stated by English & Kaufman in (Oliva, 1992, p.246) are:

"...a). "need assessment is a process of defining the desired end (or outcome, product, or result) of a given sequence of curriculum development; (b). Need assessment is a process of making specific, in some intelligible manner, what schooling should be about and how it can be assessed. Need assessment is not by itself a curricular innovation, it is a method for determining innovation is necessary and / or desirable; (c). Need assessment is an empirical process for defining the outcomes of education, and as such it is then a set of criteria by which curricula may be developed and compared; (d). Need assessment is a process for determining the validity of behavioral objectives and if standardized tests and / or criterion - referenced tests are appropriate and under what conditions;.

B. Peer Teaching

The basic concept of peer teaching was obtained from two constructivism figures (Jean Piaget and Lev. Vygotsky). Constructivism emerged as a big paradigm in the late 20th century and one of the characteristics of constructivism is unification of paradigms – linguistic paradigm, psychological, and sociological paradigms (Brown, 1994, p. 13). Constructivism is divided into a). Cognitive constructivism that emphasizes the importance of learners to build their own representation of reality. Individual students must find and change complex information if they want to master the information. In relation to students, this concept directs students to be more active in their own learning than is commonly found in most classes. This concept was inspired by Piaget's in (Brown, 2007, p. 13) that learning is a development process that involves change, self-appearance, and construction of each individu that is built on previous learning experiences.

Social constructivism emphasizes the importance of social interaction and cooperative learning in building cognitive and emotional images of reality. Vygotsky (Brown, 2007, p. 13) explained that thinking and forming meaning in children are socially formed and emerge from their social interactions with their environment.

Brown (2007) regards the meaning of learning according to the constructivism paradigm as follows:

Vygotsky views a unity in learning and development. While Piaget views the stages of development that determine preconditions, or readiness, for learning. Piaget emphasized the importance of individual cognitive development as a relative solitary act. Biological and developmental stages are fundamental affairs interaction is only triggering development at the right time (p. 13).

Piaget and Vygotsky developed two conceptions related to learning theory. Piaget - Vygotsky (Sprinthall & Sprinthall, 1974; Kessler, 1992, p. 56; Freeman & Freeman, 1994, p. 55-59; Pinter, 2006, p. 10) according to these figures the opinions expressed by Vygotsky and Piaget became the foundation used in the concept of peer teaching. Vygotsky argued that learning is essentially the impact of the process of dividual interaction with other individuals who are more capable in process for solving problems as a form of learning process..

C. Parenting Curriculum

Based on the decree of Minister of Home Affairs number 157 year 2004 about the Principle of Parenting students at Public Administration Institute of Home Affairs. Parenting curriculum is one among three system of curriculum at IPDN. This curriculum consists of the fostering and developing the students' personalities and attitude at IPDN. The development of students personalities are carried out through educational activities, both in or outside the class activities as the student's daily life at IPDN boarding school.

In parenting curriculum has three components whose responsibility for parenting the students at IPDN. They are all members of IPDN staffs (staffs, lecturers, trainers, structural officials), Local Government, Family, and Societies. The Parenting methods are keeping each other, mutual care and fostering. It also applies the Javanese leadership principles (Ing Ngarso Sung Tulodho, Ing Madyo Mangun Karso and Tut Wuri Handayani). Whenever someone becomes leader he must be able to be good example, If we are in the middle of the groups we must support each other and if we are as follower we must give supports. Another activities give by fellows (as similar as student's parents at IPDN). They have tasks for educate IPDN students outside the class for the student's attitudes.

The techniques for Parenting Curriculum are a). Persuasive, educative, humanist, example approaches; b). Giving guidance and counseling; c). Conditioning structural activities and atmosphere which must be done repeatedly and continuously for the students daily life at IPDN. It will be students behave like culture and agreed values and become a provision for all IPDN students; d). Supporting and directing all IPDN students so they can be participatory, critical, creative and innovative; e). Certain instructions for IPDN students for something that they can or can't be done.; f). Giving rewards to IPDN students in the form of awards and sanctions.

Personality development materials consist of : a). Faith: Obedient to worship, tolerance attitude and honesty; b). Care consists of social sensitivity, adaptation and responsibility; c). Ethics consist of personal, social ethics and modesty; d). Performance are appearance attitude,

personal hygiene, environmental hygiene and communication ability; e). Leadership is in the forms of ability to motivate, exemplary, decision making and activating organization; f). Discipline are self actualization, obedience the rules, self intention and independence.

D. Reading Skill

It According to Nuttall (1996) reading is able to be interpreted as, "a). Decipher Decode, identify, etc; b). Speak, pronounce, and articulate, and c). understand, respond, meaning, etc (p. 2). Reading is interpreted as a concept to read hidden messages, describe things or activities to identify. Other concepts about reading are speaking, articulating, speaking, and other similar activities. Nuttall also interpreted reading as a process of understanding, giving responses and meaning.

The three forms of above meaning will help the reader to understand the concept of reading itself. So that the nature of reading activities can be specified in various aspects of activities such as the presence of text, relating to the transfer process, the presence of speakers (can be writers or authors), readers, and various forms of media (print or visual).

Reading is also interpreted as an activity related to articulation, speech, and pronunciation activities. This meaning is often found in English language teaching activities, that relates to reading loudly. Therefore teaching English tends to lead to the teaching of pronunciation. Emphasis of teaching tends to train reading fluency, including expression in speech, and so on

The essence of reading on this concept is the meaning itself. Especially the process of meaning transfer of the author's mind to the readers' mind. It is not a simple process. There is aside of interpretation of words in foreign language texts. It is more emphasizes on how to explore meaning in reading texts on reading process carried out by the reader.

Various reasons for reading foreign language texts are not just the activities of reading loudly but also emphasizing "pronunciation" and the use of grammar in the text itself. But it is more emphasized on the aspect to get the essence of the contents of the text that it reads. Readers do reading activities because they want to get something from the reading process (capturing the messages that is presented in the text). The writer and the writing product are expected to contribute to the reading process

The need for reading is important and be able to motivate someone to increase their reading interest. Growing reading motivation becomes a very important thing that needs to be done and instilled early on, both by educators and parents. Various skills related to reading activities are proposed by Munby on Grellet (1990), such as:

...a). Determining the language's script; b). Concluding the meaning and adopting unfamiliar lexical items; c). the interpretation stated information explicitly; d). to grasp the information which does not state explicitly; e). To Understand the conceptual meaning; f). To Understand the communicative function of utterances and sentences; g). To determine the relationship of utterances in the sentence; h). To Understand the relationship between the parts of texts through

lexical cohesion devices; h). To comprehend the unity between parts of a text through grammatical devices; i). to determine the text by going outside it; j). Allowing the discourse's indicators; k). to identify the main point in a part of discourse; l). to differentiate the main idea from supporting details; m). to extract the salient points to conclude of the text; n). to select the extract of relevant point from a text; o). The main reference skills; p). Scanning for identifying specifically required information; q). Skimming; r). Diagrammatic display for transcoding information (p. 4).

The activities and objectives of reading that someone does, will have an impact on different strategies and techniques. The way to read and use is very dependent on the purpose of reading itself. It is similar with the opinions expressed by (Adler, 1972; Grellet, 1990; Nuttall, 1996), that reading is done to understand and capture the meaning of the presented text.

III. METHODOLOGY

This research is conducted in one class with mix methods (qualitative-quantitative). The first qualitative step is conducted by made observation and interview at preliminary study. In the observation, I observed 1). English teaching at three curriculum systems at IPDN; 2). The implementation of English teaching and doing some identification of English teaching problems which emerged in the class. The second steps, identified all the preliminary study data to look for the strengths, weaknesses, opportunities and threats of English teaching at IPDN. The data will be used at need analysis. Based on the need analysis, the researcher choose the the S-O strategy for solving the problems of English teaching at parenting curriculum system. The most strength is IPDN students have high potency of English knowledge combined with the opportunity for all IPDN alumni will become civil servants. Based on S-O strategy, there is program for using the high potency students in English to teach their colleagues at parenting curriculum system via English Club Union (ECU). The program is peer teaching program at ECU activity and the material is reading. The last step is developing the program by observing and evaluating .the program qualitatively and measure the result quantitatively.

IV. FINDINGS AND DISCUSSION

Looking at the conditions, needs analysis can help to solve problems and find alternative solutions based on supporting data. The ECU as an organization for learning English can be developed by involving parenting official and also trainers, even though the trainers will not teach in it, but they can discuss to give some inputs or concept for developing learning. To anticipate the limitations of teachers, the researchers utilize ECU members whose knowledge of English better than other members in the form of peer tutors. They become tutors for their peers. The theoretical foundation for this concept is the sociocultural theory of learning from Vygotsky as cited in by Velez, Cano, Whittington, & Wolf (2011) as follows:

"...the active involvement of peers, adults, and teachers in the learning process. Advanced or more knowledgeable peers, teachers, or other adult greatly

aided the learner in the construction of knowledge. Adults or peers, with greater degree of knowledge, are capable of assisting and directing the learner in such a way as to promote learning dialogue” (p. 41).

The Increasing of individual knowledge, was influenced by the active involvement of people around him who are more knowledgeable. Both peers, adults (teachers, parents) in the individual learning process. It will contribute to the development of someone's knowledge. According to Pinter, the process of interaction in both individual and social environments as mentioned above will help person's cognitive development process. For the determination of the three teaching staff from ECU members, they are carried out through written tests and interviews and the best three of them are given little knowledge and understanding regarding the teaching approach.

Regarding the need analysis, a peer teaching approach was chosen to solve the problem of learning English through ECU student activities, with the prerequisites of educators from the public provided first with simple theories of teaching. The concept of teaching theory is still given to the three *praja* who will be appointed as tutors. Remembering teaching and learning activities also require new teachers not only to learn to think as well as teachers, but also as well as true instructors. Mary Kennedy in Hammond (2006) argues that teachers need to enrich and multiply teaching experiences that vary in a wide range simultaneously. So the prerequisite for teaching and learning for beginners is to understand and respond to various aspects related to the essence of the class. They are also expected to be able to build academics life and are able to design social goals at each learning moment (Jackson, as cited in Hammond, 2006).

In addition to the aspects of the teaching approach, the teaching materials were also offered in this study. The materials that were set together by the lecturers, coaches and caregivers. The chosen and agreed materials were the material that related to the background of the students, namely the governmental knowledge. They were taken from the Culture Based's book. The consideration of selecting the materials from Culture Based's book because 1). The materials in this book are still relevant to the governmental knowledge. 2). The materials at CBU are written by English language experts and have been tested in several places. The other materials were also adopted from the Jakarta Post newspaper, and from the internet that related to the governmental knowledge.

In this study, the student's volunteers are selected from the officials at English Community Union (ECU). The reasons for selected ECU member are 1). Becoming ECU's officials needed hard selection of English. In other word, ECU officials are selected students in English lesson. 2). Selected volunteer is also done by reading placement test. The best 3 volunteers among 15 members will be the volunteers of the activities.

The fifteen participants in the reading placement test were divided into three (3) groups. They were asked to choose material for the model development activities of the three given materials. So they can choose one topic of government reading texts that they are studying. The results of their choice were asked to be typed and sent via email to

the English teaching team at IPDN. The three reading materials are: 1). Our Capital City; 2). Reformation should deals with corruption; 3). Pancasila.

The three English teaching materials were processed by IPDN English teaching staffs. They also determined the format and scenarios of peer teaching learning concepts with some steps, plan-do-see phases. These phases are applied together with and without volunteers specifically related to teaching and learning theories that will be given to volunteers before. It's also the material that will be taught by volunteers (*praja*). The evaluation activities will be given in the end, and it will be used as a tool for comparison between the result of learning before and after treatment.

In try out, the plan-do-see approach is carried out from the initial to the final stages of peer teaching learning activities. So does the supplying of teaching materials for volunteers starting with and without providing teaching knowledge to each volunteer up to the reflection activities that contain supplying the teaching theory that was carried out in the activity.

The various results were obtained at the initial treatment, where volunteers were not given the teaching concept. In the first trial conducted by the volunteers, were obtained: a). Volunteer 1 (V1) taught the material by providing initial illustrations related to the material/topic is, "Reformation Should Deals with Corruption". In this step, V1 gave some explanation of the corruption condition in Indonesia; b). V1 was very active, he told all the content in the reading text and V1 taught his colleagues tend to be reading the story telling. c). V1 tends to be very active and less attention to his colleagues whose become his students; d). In the last session V1 asked his friends to ask some questions about the material and V1 would explain the answer. In the initial treatment, the tendencies of teaching conducted by V1 tends to be teacher centred (teacher is very active and less participation of the students).

V2 equipped with various teaching knowledge. V2 also had learned more from teaching reflection sessions at V1 activities. V2 has a little more knowledge than V1 in teaching concept. In the implementation of peer teaching, V2 tried to connect between material concepts with his colleagues' question and answer sessions. V2 asked his colleagues to read the reading text silently. Then the questions related to the material were given to his colleagues, it means V2 tries to make his colleagues more active in the teaching learning process. V2 also observed inactive colleagues by involving their colleagues with questions so that they are also active. In this occasion, it appears V2 like a facilitator who tried to activate his colleagues to argue. His colleagues are more active in learning guided by V2. Although in answering his colleague's question, V2 is like forcing his own opinion.

The volunteer 3 (V3) is more ready with some preparation of teaching before doing teaching in front of his friends. V3 had some information about teaching learning concept from English team teacher. V3 also followed the reflection sessions of V1 and V2. V3 had more information about teaching concepts. Before conducting the real teaching, V3 practiced to teach V1 and V2, for preparing his mentality, teaching materials and teaching strategies. V3 also had some reflection in the mini teaching with V1 and

V2. The reflection became a kind of input for V3 in preparing the teaching activities in front of his colleagues. The results of the learning activities conducted by V3 are a). V3 was more ready to do teaching activities; b). V3 is still nervous, but it's not too obvious; c). The results of interviews with participants who took part in the learning program also said that V3 was more ready and had different ways for delivering the material. d). V3 is more communicative and flexible in providing and delivering material. It can be identified from the interview results of V3, such as:

V3: that's right mam, it is different when I taught in team teaching. I felt more confidence rather than before, even I felt nervous in the beginning. But I can manage myself so it made the situation normal and the class can run well. I can explain the materials to my colleagues. Thank you, mam, I will try to learn more and more. I love teaching activity. He also said that in the future he wants to be IPDN lecturer.

Based on the steps that are conducted in this study, the steps of peer teaching can be described below:

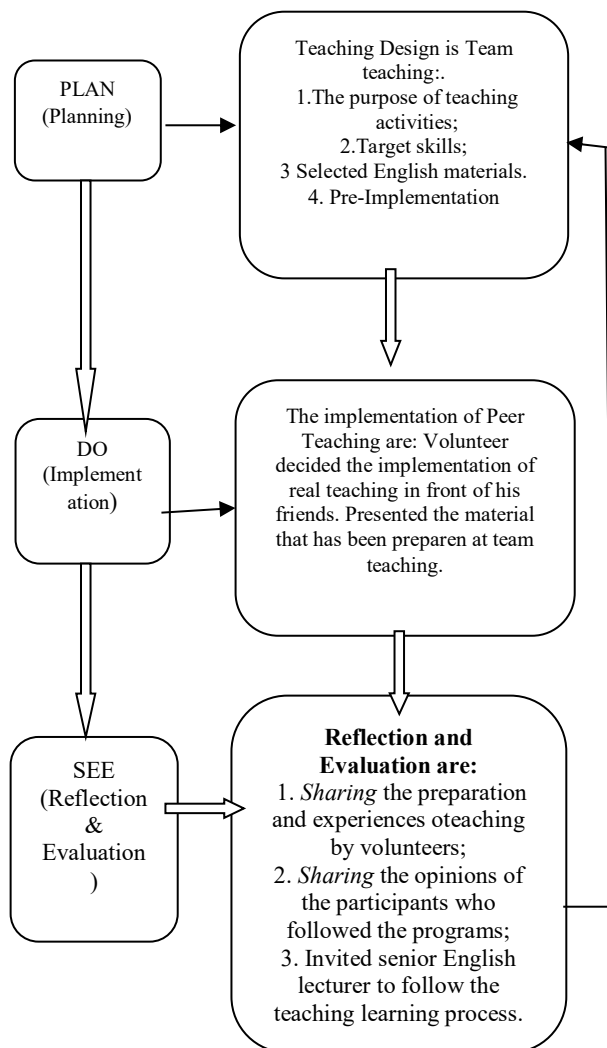

The implementation of English teaching via peer teaching has been tested through limited group (15 students) of English Community Union (ECU). It is also tested to extensive group in one class show the effective results in improving the ability English reading for IPDN students. It can be seen from the increasing score in the pre-test and also in the 3rd post-test in limited and extensive tests.

The results of pre-test score have increase at post test score consecutively. from 51.78 when the pre-test became 59.55, the first post-test, 75.11 at the second post-test, and 81.33 at the 3rd post-test. At the limited and extensive test.

V. CONCLUSION

The problem of teaching learning English at the parenting curriculum can be solved by using the Peer teaching approach. It focused on reading material. The offered concept of peer teaching to *praja* will be done well when students are also collaborating with lecturers, trainers, and other staffs of English as facilitators of the learning activities.

The requirements for planning the activities before being applied to real classes are also a prerequisite for making learning in large classes applicable. This concept will be more applicable to learning in boarding schools such as IPDN because students live in the same place. So that the use of students with English language skills that can be more empowered to improve other English language skills.

Activities that can foster an independent spirit and togetherness in learning a foreign language. From the results of extensive testing and limited testing it appears that learning activities with English on reading material using the peer teaching approach have an impact on significantly increasing the ability to read *praja*.

The problem of teaching learning English at the parenting curriculum can be solved by using the Peer teaching approach. It focused on reading material. The offered concept of peer teaching to *praja* will be done well when students are also collaborating with lecturers, trainers, and other staffs of English as facilitators of the learning activities.

The requirements for planning the activities before being applied to real classes are also a prerequisite for making learning in large classes applicable. This concept will be more applicable to learning in boarding schools such as IPDN because students live in the same place. So that the use of students with English language skills that can be more empowered to improve other English language skills. Activities that can foster an independent spirit and togetherness in learning a foreign language. From the results of extensive testing and limited testing it appears that learning activities with English on reading material using the peer teaching approach have an impact on significantly increasing the ability to read *praja*.

REFERENCES

- Adler, J., & Doren, V. C. (1972). *How to read a book*. United States of America: Simon & Schuster, Inc.
- Brown, H. D. (1994). Teaching by principles. *An Interactive Approach to Language Pedagogy*. New Jersey: Prentice-Hall, Inc.
- Freeman, D. E., & Freeman, Y. S. (1994). *Between worlds: Access to second language acquisition*. Portsmouth: Heinemann.
- Grellet, F. (1990). *Developing reading skills: A practical guide to reading comprehension exercise*. Great Britain: Cambridge University Press
- Hammond, L. D. (2006). *Powerful teacher education*. San Francisco: Jossey Bass
- Kessler, C. (1992). Cooperative language learning. *A Teacher's Resource Book*. Englewood Cliffs: Prentice-Hall, Inc.
- Nuttall, C. (1996). *Teaching reading skills in a foreign language*. United Kingdom: Macmillan Heinemann.
- McNeil, J. D. (2014). *Contemporary curriculum: In thought and action*. Los Angeles: John Wiley & Sons.
- Oliva, F. P. (1992). *Developing the curriculum*. United States of America: Harper Collins Publishers.
- Pinter, A. (2006). *Teaching young language learners*. Oxford: Oxford University Press.
- Sprinthall, R. C., & Sprinthall, N. A. (1974). *Educational psychology: A developmental approach*. Massachusetts: Addison Wesley Publishing Company.
- Velez, J. J., Cano, J., Whittington, M. S., & Wolf, K. J. (2011). Cultivating change through peer teaching. *Journal of Agricultural Education*, 52(1), 40-49.

A Literature Study: Relationship between the Translation Competency and Translation Quality

Meidya Laksmi Ariyanti
 Postgraduate Faculty
 Yogyakarta State University
 Yogyakarta, Indonesia
 meidya@gmail.com

Sufriati Tanjung
 German Literature Department
 Yogyakarta State University
 Sleman, Indonesia

Abstract—*Translation competency consists of knowledge and skills acquired by translators to produce a good quality translation. Translation competency includes formal education and / or translation trainings which translators have ever taken. Even so, many translators in Indonesia do not have backgrounds of acquiring formal education and / or attending translation trainings. In this regard, this literature study was conducted to investigate regarding the relationship between the translation competency and the translation quality. By examining some related academic researches and supported by some relevant theories, the result shows that the translation competency affected the quality of translations produced by the translators.*

Keywords—*Translation Competency, Translation Quality, Educational and/or Translation Trainings*

INTRODUCTION

Translation is generally interpreted as a form of transfers of words, sentences, paragraphs, and a text from the source language into the target language. Simatupang (2000) described a process of translation as an activity of meaning transferring from the source language to the target language which was manifested in an appropriate form as possible, according to the linguistic and language rules that applied in the target country. Being appropriate means the translators transfer the meaning with a high accuracy, so that the content of the source text and the content of the target text will be talking the same, and the translation will be equivalent with the original text.

Furthermore, referring to the words '*sewajarnya*' (equivalent) or '*wajar*' (equivalent) that are similar in meaning with the words '*seimbang*' (level), '*sepadan*' (match), and '*equivalen*' (equivalent) in *Kamus Besar Bahasa Indonesia* (The Great Dictionary of Indonesian Language), in the translating activities, the translators really need to pay attention to the equivalence of the words and meanings that are being translated. Some experts, such as Pinhhuck (1977) emphasized that in the translation activities, the translators needed to find the equivalence in the target language for the conversations in the source language. This statement was later supported by Bell (1991) who also said that in finding the results of translations or expressions (conversations or writings) in other languages, the translators must maintain the semantic equivalence and

language style from the source language. Furthermore, Nida (In Lie, 2005) provided the clearest understanding regarding to the translation process. He stated that translation process:

“...consists of reproducing in the receptor language the closest natural equivalent to the message of the (original) language, first in terms of meaning and secondly in terms of style. By natural, we mean that the equivalent meaning forms should not be ‘foreign’ either in form or meaning.”

Thus, in translating a text or a conversation, the translators are required to find the most natural or normal equivalences in the realm of meaning and style of the target language, so that the listeners or readers from the target language countries do not find it strange or weird both from the form of the text and the meaning of the text. Besides that, the most natural and precise equivalents that have been found will also determine the quality of translation results. If the translators are unable to find the equivalence of the words to be translated, it will consequently affect the quality of the final translation. Directly, it will also hinder the target readers to understand the content of the text easily.

In his thesis entitled Profile Case Study of Half Professional Translators with Translation Educational Background and without Translation Educational Background and the Quality of Their Translation Results), Christian (2015) stated that during Publisher and Translator Meeting Forum at Atmajaya University on September 23, 2013, most of the present translators admitted that they did not have any translation educational backgrounds. Many translators claimed that they only had the provision of foreign language skill and expertise in certain fields of science. This indirectly implies that many translators in Indonesia who do not have formal or non-formal translation educational backgrounds are frugally determined to choose the profession as a translator with only having a backup of foreign language skills, which is practically not enough for becoming a professional translator. In addition, this phenomenon also shows that the role of formal and non-formal translation educational background are still ruled out by most translators because they assume that mastering foreign languages is enough to be used as a sole translation competency that must be mastered to work as a translator.

In one of the electronic articles of the Association of Indonesian Translators, it explained that it was not a legally

and officially must if the people who wanted to choose the profession as a translator have to acquire a diploma and / or certain certificates related to the translation studies. However, those people who wanted to become translators were advised to take the formal education or translation trainings to improve their skills and become a plus aspect or strength for a translator. Like other professions, today's translators are required to continue sharpening their skills, expanding their knowledge, and following the development of foreign languages and general knowledge in order to improve their quality as a translator (HPI, 2011). Similar with the Association of Indonesian Translators, Listyo (2009) also said the fact that was many sworn translators have only one formal translation educational background, for example literatures or law. However, if the translators have mastered the two scientific backgrounds, coupled with other disciplines, it will certainly be better for the competency of the translators and the quality of their translations.

Thus, from the two explanations above, it can be concluded that currently in Indonesia, the attention of translators towards the translation competency which is related to the formal and non-formal education in translation is still lacking. Eventhough the formal and non-formal education of translation are not an absolute requirement that must be full filled by a translator, this requirement will be able to enhance the quality of the translators, so that they are able to produce better and more accurate translations.

The purpose of making this article is to build the conception more powerfully based on empirical researches that exist. This article also wants to invite all translators to understand the importance of formal and non-formal education of translation in order to produce better quality translations because a good quality translation will be beneficial for the customers, but if the translation is not in a good quality, the customers will also get the bad impacts from their business related to the translation.

LITERATURE REVIEW

The success level of a translator in translating, the professionalism of a translator and the credibility of a translator can be measured by determining the quality of the translation results that they have produced so far. With the translation competencies that have been mastered so far, we can measure and compare the quality of the translations that have been produced. Larson (1984) described that there were three aspects that needed to be considered in assessing the quality of the translation results. The three aspects are as follows:

1) *Accuracy*

Accuracy refers to the equivalence of source language texts with the target language texts (Nababan, Nuraeni, & Sumardiono, 2012). The intended equivalence means the equivalence of the content and text messages. The translators must be able to consider these matters, so that there will be no content and text messages that are omitted, added, changed, or ignored (Simatupang, 2000). The levels of accuracy of the translation results include: Accurate, Less Accurate, and Inaccurate.

2) *Acceptability*

Acceptability is interpreted as the naturalness of a translation text for the target readers related to the system of language and the target cultures. It means that the words in the target texts are acceptable and understandable for the target readers from the perspective of their cultures. Furthermore, Nababan, Nuraeni, and Sumardiono (2012) also explained that the term of acceptability refers to whether the translations that have been produced by the translators are in accordance with the rules, norms, and cultures that apply in the target language or not, both in the micro level and in the macro level. The acceptability parameter is divided into three levels which are: Acceptable, Less Acceptable, and Unacceptable.

3) *Readability*

Richards (in Nababan, 2008) explained that the aspect of readability referred to how easy a translation text can be understood by the target readers. Being readable means that the target readers do not have to do many repetitions in reading the text to understand the meaning of a part of text. This statement was also supported by Pinto (2001) who said that, "one important measurement of quality should be the clarity and readability of the final product" (p. 298). The readability parameter is divided into three levels which are High Readability, Moderate Readability, and Low Readability.

With the existences of those three translation quality assessment parameters, there is a possibility that the quality of the translation results can be measured scientifically. This procedure of assessment of the quality of translation results has been used in many research studies related to the field of translation, so that the credibility of this translation quality assessment procedure is undoubtedly accurate according to the academicians. However, to get high scores in all those three parameters, what should translators do about their translation?

Shreve (in Nababan, 2004) stated that the translation competency was a part of communication competency that discussed the translation and how to translate, how to produce a perfect and accurate translation by considering the origin and the appropriateness according to the cultural contexts of the original country and the target country. Therefore, the translation competency is an important matter that must be mastered by the translators in order to produce accurate, acceptable, and readable translations, or in other words, the translators are able to produce good quality translations. The translation competency itself generally consists of the abilities related to the translation process, including the knowledge about how to translate well. In this regards, according to Gile (1995), the translation competency is possibly to be achieved through providing the translators with much translation knowledge obtained from the formal education and / or non-formal education of translation.

1) Formal Education of Translation

The participants who want to be a translator take the tiered academic education, such as at a university level which provides undergraduate, postgraduate, and doctoral levels of translation studies, and or intensive programs that take six months to four years related to translation studies in the public language institutions or private language institutions.

2) Non-Formal Education of Translation

The participants receive trainings specialized in translation studies with a relatively shorter period of time than the formal education of translation. This educational choice does not require the participants to take it in stages like the formal education of translation, so that anyone can take part in the trainings (Christian, 2015).

By attending the formal education and / or non-formal education of translation, the translators and the prospective translators will gain the theoretical and practical knowledge which are useful about how to become an expert and professional translator, so that they can produce good quality translations.

The skill level of translators itself has been mentioned by Presas before. Presas (in Nababan et al., 2004), stated that there were four main differences between the expert translators and the amateur translators, which were based on the special skills on linguistics, bilingual memory, interference control when understanding and producing information, and the transferability. For the amateur translators, their special skill on linguistics are not as deep as the expert translators. In the bilingual memory aspect, the expert translators are categorized as coordinate translators while the amateur translators are categorized as subordinate translators. Then, in the relation to the interference control, the expert translators can control the interferences properly when understanding and producing information while the amateur translators cannot do it as well as the expert translators. Finally, in the term of transferability, the expert translators tend to consider the transferring process at the text level while the amateur translators view the translation as a process of code switching at the word level, like a bilingual person. So it can be assumed that the expert translators have a higher translation competency than the amateur translators, because they have more and deeper knowledge and expertise related to the field of translation. This will directly affect the quality of the translation results, which also result in producing translations in a low or high quality.

Furthermore, it cannot be denied that there are two main competencies that must be mastered by a person before deciding to take on the profession as a translator, namely mastering of foreign languages and the field of translation studies. For example, if someone wants to become an Indonesian-English translator, s/he must master Indonesian and English languages very well, and if s/he wants to take up the field of law as the specialty of translation, s/he must have a fairly deep knowledge in the field of law. This statement is emphasized by Gile (1995) who stated that:

“Translators must know how to translate. This component refers to the conceptual framework

and technical skills. It involves comprehension of principles of fidelity and of professional rules of conduct, both technical and human, but it also involves techniques for knowledge acquisition, for language maintenance, for problem-solving, for decision-making” (p. 5).

The point of Gile’s statement is that translators must be able to understand the framework of the translation concept in more depth, adhere to the principle of translation loyalty and rules of translation, and be able to make wise decisions when encountering problems related to translation when conducting translation activities, so that they can produce good and accurate translations. In line with Gile, Said El Shiyab (in Nababan, 2008) also mentions that,

“Teaching the theory of translation to students of translation is important. If the theory stops short at studying the semantics, syntactic analysis of language, the students of translation may find themselves unable to render the text effectively and communicatively into the target language” (p. 2).

Thus, to produce a more effective and communicative translation, the translators or prospective translators need to learn the basic theories of translation as well as advanced theories of translation, so that they will be more careful in translating a text or conversation and will be able to produce good quality translations.

In addition to the translation competencies that have been briefly described by Gile and Shiyab, in his thesis entitled *The Quality of Individual and Group Translation Results (A Case Study of Translation Process and Results of Postgraduate Students in Linguistics Study Program of UNS with Translation Studies as the Main Concentration)*, Kurnianingtyas (2008) also categorized the competencies into several groups, which are:

1) *Linguistic Competence*

Linguistic competence is the most vital competency that must be possessed by translators because the core of the translation activities carried out by the translators is transferring the text from one language to another language, so that the linguistic skills of the translator greatly affect the quality of the translation results. Viennes (as cited in Kurnianingtyas, 2008) explained that the linguistic competence was to master the source language and produced it back into the target language.

2) *Textual Competence*

Schaffner described the textual competence as a “knowledge of regularities and conventions of texts, genres, text types.” Thus, the translators must be able to recognize various types of texts and be able to translate various types of text with certain appropriate techniques.

3) *Domain/ Subject Specific Competence*

This competency refers to the skill of the translators to master the text material which will be translated. It does not mean that the translators must be an expert in a particular field of science to be able to do the translation process, yet

the translators must at least understand the field of science of the translated text. According PACTE (as cited in Kurnianingtyas, 2008), this matter was related to the general knowledge and special knowledge that could be utilized in accordance with the material of the translated text.

4) *Cultural Competence*

The translators must master or at least know the culture of both countries of the source text and the target text. With this skill, the translators will be able to find the equivalent terms more easily because they have already had sufficient knowledge of the cultures of the two countries of the source text and the target text, and the translators will be able to minimize the confusion and they will be able to make new terms become acceptable for the target readers. This action will also help the target readers to understand the text more easily.

5) *Research Competence*

Orozco and Albir (as cited in Kurnianingtyas, 2008) stated that, "strategic competence is essential because it affects the others, making up for deficiencies and solving problems in all of them" (p. 376). This competency is closely related to the ability of the translators to solve problems related to decision making in translation activities. Decision making includes the translation method, translation strategy, and translation technique because each text is different and it needs special treatments according to the genre or form of the source text.

6) *Transfer Competence*

This competency is related to the ability of the translators to transfer messages from the source language into the target language where the translators must be able to maintain the meanings while expressing the meanings precisely and clearly into the target language.

The six competencies are one compilation of competency categories expressed by several experts, and there are many other experts who are oriented in the field of translation who have their own definitions and categories to describe the concept of translation competency that a translator must have. However, most experts agree that the translation competency not only includes bilingual competencies, such as mastering the two languages (the source language and the target language) or more, but also includes the linguistic and theoretical competencies related to the field of translation. The translator are not only responsible for transferring messages from one language to another, but they are also required and responsible to transfer forms, structures, styles, cultures, and so on. The transfers of various aspects in the text are not enough to be done by only using bilingual competency, but it demands more competency which is the theory of translation.

METHODOLOGY

This research is a literature study research. The researcher examines three academic articles related to this topic which is the relationship between the translation competency and translation quality. Meanwhile, the relevant theories will also support and strengthen the analysis. This result of this literature study research will be used to strengthen the conception about the importance of translation competency towards the translation quality with the hope that many translators in Indonesia will consider about the importance of translation competency, especially

the translation knowledge acquired through formal education and / or translation trainings, so that it will help them to improve their translation skill.

RESULT AND ANALYSIS

After reviewing some theories that had been presented by the experts regarding to the definition and urgency of translation competency, the researcher then looked for some research evidences through academic writings, journals, and researches that were relevant to the topic. The researcher found that there were several fields of research conducted by some academicians regarding to this matter in Indonesia. The academicians, journal writers, and researchers questioned that whether the translation competency in the field of education and / or translator training were important to be acquired, and examined the influences of the participation and non-participation of translators towards the quality of the translation.

It had been mentioned previously that many experts had their own definitions to describe the concept of translation competency, one of whom was Schaffner, Adab, and Anderson (in Nababan 2008) who said that the translators must have translation knowledge, so that they can do the translation process well. This knowledge included declarative knowledge (knowledge of translation) and procedural knowledge (knowledge of how to translate). Anderson (in PACTE, 2005) then described these declarative and procedural knowledge as follows:

"Declarative knowledge consists of knowing what: it is easily verbalized; it is acquired by being exposed to information and its use is normally controlled (e.g., knowing the addresses of web pages that are useful for translator documentation). On the other hand, procedural knowledge consists of knowing how: it is difficult to verbalize; it is acquired through practice and its use is mainly automatic (e.g., knowing how to use a web page to guarantee a translation's precision and economy)" (p. 4).

In other words, the declarative knowledge includes what the translators must possess before translating a text or a work, for example of the theoretical knowledge, there are the knowledge of structure and grammar of foreign languages, the ability to use foreign languages, and the knowledge of source language and foreign languages cultures. On the other hand, the procedural knowledge involves knowledge of how to use or how to apply the declarative knowledge that has been acquired so far, about what steps should be taken by the translators when conducting the translation activities, such as considering the structures of languages (source and target language), language cultures (source and target language), or the type of text that the translators wish to translate. Such knowledge can only be obtained through education and translation trainings. In the translation teaching institutions or any institutions that provides knowledge regarding to the translation studies, the students and participants will be equipped with theoretical and practical knowledge of

translation in a more directed and detailed manner with the focus on the translation studies curriculum, learning design, and syllabus that has been prepared by the educational management of translation studies and training institutions. For example, in the Undergraduate Translation Education curriculum at Universitas Terbuka, the students are taught English grammars, Indonesian grammars, and linguistics in stages for 6 consecutive semesters. In the 3 years from 4 years of study, the students are taught grammars and linguistics in a row. Another example is Universitas Udayana, specifically the Linguistics Postgraduate Program concentrated in Translation. In the curriculums of Linguistics Postgraduate Program that have been compiled for the concentration of Translation, the students are taught about advanced translation theories, text genre analysis, semantics, and translation practices. This curriculum shows that the teaching materials included in the educational curriculum are one of the real forms of declarative knowledge and procedural knowledge needed by a translator to improve their translating skills and the quality of their translation results. It would be a bit difficult if the translator wants to learn or obtain this knowledge by self-taught without taking an official education path because it should be taught by professional teachers, so that they can be directed to acquire the complete skill of translating. If the translator learns this knowledge by self-taught, it will automatically affect the translator's understanding, and the translator will also not get official recognition or official diplomas / certificates that are needed by the translator to convince the consumers that they are indeed professional translators. Without any soundings regarding to this matter, many translators then will only rely on their bilingual skills and have no desire to improve their abilities in the field of translation.

In his thesis entitled Profile Case Study of Half Professional Translators with Translation Education Background and Without Translation Education Background and the Quality of Their Translation Results, Christian (2015) examined and discussed the background of the translators especially the translation educational background, the quality of the translation results that they produced, as well as the relationship between the background and the quality of their translations. The researcher chose three translators with different educational and occupational backgrounds. From the results of the study, it was found that Translator 1 had the best translation quality for the type of text that matched its specialization and the type of text outside its specialty, Translator 2 was ranked 2nd for the level of quality of translation, and Translator 3 was last, or it could be said that Translator 3 produced the lowest quality translation to begin with. Furthermore, based on the research, it was found that the translation educational background (Postgraduate Program / Master) possessed by Translator 1 had a major influence for the translator to produce high quality translations. The hypothesis was proven by the translation results of Translator 1 which have high translation quality both in terms of accuracy, acceptability, and readability after being assessed by some expert judgments. In addition, the type of occupation of Translator 1 also has a huge influence for the

translator to produce high quality translations compared to other two translators whose types of occupation are less or irrelevant to the field of translation. For additional information, Translator 2 works as an English teacher and Translator 3 works as an owner of computer rentals and bookbinding.

If the researcher considers the translation educational background possessed by Translator 1, it is very possible if he does master the declarative and procedural knowledge that the translator really needs in the translation process, as what Anderson had explained before. The theoretical and practical knowledge were obtained by Translator 1 by taking a Master degree in Translation. The expertise of Translator 1 was proven by the quality of the translations from Translator 1 which get the highest score among the three translators even though the experiences of translating Translator 1 is in the minimum time, compared to the other two translators, which was only 1 year. On the other hand, the translations of Translator 2 and Translator 3 got lower scores than Translator 1, but Translator 2 still got a higher score than Translator 3 with 3 years of translating experience. This happened because Translator 2 still has sufficient target language skills. In fact, he has taken the English Language Education for the his undergraduate program and is currently working as an English teacher, so that the quality of the translation produced can still be categorized as good according to the informants or raters who assessed his translations. Translator 2 at least has sufficient bilingual language skill to transfer the original text into the target language. However, for Translator 3, because he does not have a translation education background or he does not acquire the target language properly and sufficiently, it can be assumed that he lacks adequate declarative and procedural translation knowledge, as evidenced by the lowest translation score of the three translators even though he has 10 years of translating experience.

Furthermore, from the five basic premises of the holistic model of translation competency described by PACTE (2005), one of them stated that the translation competency is different from the bilingual competency, but the bilingual competence is one of the sub-competencies that must be mastered by translators. Translation activities not only involve the transfer of messages from one language to another, but many things must be considered in the transfer process, such as (Eser, 2015) pragmatics, sociolinguistics, and grammar-lexical and textual knowledge of each of these languages, and Translator 3 does not have these competencies. If it is related to the research mentioned earlier, Translators 1 and 2 have followed the translation procedures well so as to produce high quality translations. But for Translator 3, the translation process that he did was only involving the bilingual competency with sufficient, tend to not enough bilingual language skill, so that the final result of translation has the low quality. Although from the three translators, Translator 3 had the most working hours of translation, which is 10 years, but this did not guarantee that he would later become an expert in the field of translation or his translation skill would improve. Experience is one aspect that affects the quality of the

results of the translation, but if the translator only relies on his experience without providing it with sufficient theoretical and practical knowledge then that is not enough to improve his translation skill correlated with his translation quality.

Similar to Christian's research (2015) on the importance of translation competencies to produce high quality translations, Saksono and Inayati in their research entitled "Strengthening Translation Trainings for Amateur Translators as an Effort to Improve the Quality of Translators in Madura" also discussed the importance of translation training to improve the quality of the translation. In the study, it was found that most translators in Madura did not have sufficient translation competencies. Many of the translators do not recognize that multi-competencies are needed for a translator, and the translation activities they do all this time only involve the transfer of messages from the source language to the target language by ignoring proper translation procedures. The actions of the translators in Madura were in contrast with the statement of PACTE (2005) who stated that the sub-competencies of translation includes bilingualism, extra linguistic, professional, psychology, transfer, and strategy mastery, while in the case of the translators in Madura, what they master and they consider important is only the mastery of two languages. In addition, from the research, it was found that translators also did not understand the source language well. They were not immediately able to understand the main ideas of source language texts. They also faced difficulties in finding and matching difficult words, and were unable to write in the target language easily. The characteristics that have been described from the translators in Madura are in accordance with the criteria proposed by Presas about amateur translators. Amateur translators, according to Presas (in Nababan et al., 2004), did not have sufficient specialized language skills, difficulties in capturing the main ideas of a text, and have the ability to transfer text messages that are still in word for word order of the translation process. These conditions clearly affect the quality of the translation produced when it was assessed from the parameters of accuracy, acceptability, and readability. The translation quality of professional translators and amateur translators must also be completely different. Although it is not a necessity for the translators to take part in translation education or translation training if they do using the translating profession as a side job and they are only limited to the translation of certain texts or for certain purposes, according to Machali (2000), by taking translation education and translation trainings, they can fulfill two important things, which are helping them if they want to become professional translators for their self-development and skills, and helping the self-development of translators in a more directed and precise manner through joint practices, workshops, and direct teaching-learning.

By improving the translation skills through translation education or translation trainings, the quality of the translations that they produce will also be better, and this will certainly provide satisfaction for the consumers of the translation services.

CONCLUSIONS AND RECOMMENDATIONS

After investigating some academic researches accompanied by some relevant theories, from the literature study above regarding to the relationship between the translation competencies and the quality of the translation results, especially those competencies obtained through formal education and non-formal translation, it can be concluded that:

- 1) Formal and/ or non-formal translation education are important to be taken by translators and prospective translators in order to get better translation quality and to increase the professionalism of translators in the eyes of the consumers.
- 2) The translation competencies obtained through education and training include declarative and procedural knowledge regarding to the science of translation and the procedures to translate well and right. The knowledge is manifested in numbers of undergraduate and master education curriculums that concentrate on the field of translation.
- 3) There are several field studies conducted in Indonesia regarding to this matter and it was found that there is indeed a positive correlation between educational background and / or translation training with the quality of the translation results. One study measured the quality of translation from the level of accuracy, readability, and acceptability by considering the background of the translator and the translator's experience with the quality of the translation results. Other studies examined the translation quality of amateur translators and find that the quality of the translations produced is still relatively low because most translators only rely on bilingual competency.
- 4) Experience is one of the translation competencies that determine the quality of the translator's translation, but it was not the only reliable competency. This competency must be supported by other translation competencies, namely theoretical and practical (declarative and procedural) knowledge obtained through education and / or translation trainings.

REFERENCES

- Bell, R. T. (1991). *Translation and translating: theory and practice*. London: Longman.
- Christian, D. S. (2015). *Studi Kasus Profil Penerjemah Semi-h Berlatar Belakang Pendidikan Penerjemahan dan Tanpa Latar Belakang Pendidikan Penerjemahan serta Kualitas Hasil Terjemahan Mereka*. Surakarta: Universitas Negeri Sebelas Maret a Thesis in <http://eprints.uns.ac.id/16892.pdf>.
- Eser, O. (2015). A model of translator's competence from an Educational perspective". *International Journal of Comparative Literature and Translation Studies*, 3(1).
- Gile, D. (1995). *Basic concepts and models for interpreter and translator training*. Amsterdam/Philadelphia: John Benjamin Publishing Company.
- Himpunan Penerjemah Indonesia. (2011). *Kiat untuk pengguna jasa penerjemah*. Retrieved in May 6

- 2016 from <http://www.hpi.or.id/kiat-memilih-penerjemah>.
- Kurnianingtyas S. (2008). *Kualitas Hasil Penerjemahan Individu dan Penerjemahan Kelompok (Studi Kasus Proses dan Hasil Penerjemahan Mahasiswa Pascasarjana Program Studi Linguistik Minat Utama Penerjemahan Universitas Sebelas Maret Surakarta)*. Tesis. Surakarta: Universitas Negeri Sebelas Maret a Thesis in <http://eprints.uns.ac.id/8221/1/80322107200905561.pdf>.
- Larson, M. (1984). *Meaning based translation: A guide to cross language equivalence*. Boston: University Press of America Inc.
- Lie, A. (2005). *Cooperative learning: mempraktikkan cooperative learning di ruang-ruang kelas*. Jakarta: Grasindo.
- Listyo, I. (2009). Penerjemah bersumpah. Accessed in May 6 2016 from <http://blog.bahtera.org/2009/08/penerjemah-bersumpah/>.
- Machali, R. (2000). *Pedoman bagi penerjemah*. Jakarta: Grasindo.
- Nababan, M. R. (2008). *Teori menerjemah Bahasa Inggris*. Yogyakarta: Pustaka Pelajar.
- Nababan, M. R., Nuraeni, M., & Sumardiono. (2012). *Pengembangan model penilaian kualitas terjemahan*. Surakarta: Universitas Sebelas Maret.
- Nababan, M. R., Subroto, E., & Sumarlam. (2004). *Keterkaitan antara latar belakang penerjemah dengan proses penerjemahan dan kualitas terjemahan*. Surakarta: Universitas Sebelas Maret.
- Pinto, M. (2001). Quality factors in documentary translation. *Meta: Translators' Journal*. 46(2), 288-300.
- Saksono, S. T. and Inayati, R. (n.d.). "Penguatan Pelatihan Penerjemahan Bagi Penerjemah Pemula sebagai Upaya Peningkatan Kualitas Penerjemah di Madura". <http://journal.trunojoyo.ac.id/prosodi/article/download/51/73>.
- Simatupang, M. D. S. (2000). *Pengantar teori terjemahan*. Jakarta: Direktorat Jenderal Pendidikan Tinggi.

The Approach of English Language Learning: Study Case Grammar

I Gede Neil Prajamukti Wardhana
 English Literature Department
 Universitas Dhyana Pura
 Badung, Indonesia
 neilwardhana@undhirabali.ac.id

Abstract—Nowadays, English learning still indicates to English grammar approach to students and make students find their difficult to understand their meaning. The ability of English language as a second language in English learning at the class make the students find difficult because of their mother language that is Indonesian language. Therefore, it needs to make English grammar approach by study case grammar (Fillmore, 1968). This study has been done on the student in Dhyana Pura University, English literature program in the 4th semester in the academic year 2018/2019. There are 13 students for the sample of this research by finding their sentence and based on the case grammar itself. Method of collecting data is done by observe the student and giving material of case grammar and give an activity by doing exercise to write case grammar from the students. The data is analyzed by checked and made correction of the sentence. This study case grammar, the students gave the examples of verb words by lecture and the students made sentence and finally, made the correction for students. In this study found 9 (nine) of study case grammar, they are agentive, objective, instrumental, dative, locative, benefactive, comitative, factitive and time. In case of Agentive, example: Fajar prepared the table. This sentence for Agentive described Fajar (a waiter) as a subject of the sentence.

Keywords— approach; English; case grammar

I. INTRODUCTION

Nowadays, English learning still indicates to English grammar approach to students and make students find they are difficult to understand their meaning. So, that student becomes wrong or lack of understanding with their sentences made especially in the use of English grammar. The era 4.0, English grammar still needed to everyone or student that wants to learn English at the university level and wants to find out their career in hotel and tourism. In this case, the student at university-level that wants to be a manager in hotel and tourism, at least they should know and familiar with writing and speaking ability. In Bali, as the island of tourist that come and enjoy the scenery, art, culture, and foods, they want to know more about Bali, so

we need to learn about English grammar. On the other hand, the ability of the English language as a second language in English learning at the class make the students find difficult because of their mother language that is the Indonesian language. Therefore, it needs to make English grammar approach by study case grammar This is also related to the use of the verb in English, for example in the case of grammar according to Fillmore (in James, 1980) using case-frames, it is the word “open”. The word “open” can issue the sentence that refers to Agentive, Objective, Instrumental, Dative, and Locative. Case Grammar is a modification from Generative Transform Grammar that explains argument and predicate in one of proposition (Kridalaksana, 2013). This is also related to the statement from Chomsky (in James, 1980) that refers to the case grammar and used to Agentive, Objective, Instrumental, Dative, and Locative. So, if the word “open” is made in a sentence then it would be

- a. i. The door open (-O)
- b. ii. John opened the door (-O+A)
- c. iii. The wind opened the door (-O+I)
- d. iv. John opened the door with a chisel (-O+I+A)

The use of the “open” verb can be made into a few sentences for the use of case grammar with limitations on use Agentive, Objective, Instrumental, Dative and Locative. So that’s why grammar especially for English grammar is still needed and important also for 4.0. The other reason, in the hotel for all staff members, they should know and understand about English speaking and writing when they interact or communicate to the guest. The general aim of this study is to give the frame of learning implementation about English study case grammar to the student in the 4th semester in the year 2018/2019. The specific aims of the study are to know about English case grammar learning to the student in the 4th semester in the year 2018/2019. To apply the used of English case grammar to the student in the 4th semester in the year 2018/2019. The benefit of this research divides into 2 are benefit for academic and for practical also. For the academic is to give the knowledge of the study English case grammar and for the practical to learn used for English case grammar to students. Based on the

description of the introduction, there are 2 problems that discussed

A. Is it effective to use of English case grammar for English learning in the 4th-semester student academic year 2018/2019?

B. How does study English case grammar learning to apply in the 4th-semester student academic year 2018/2019?

II. FRAMEWORK THEORY

The literature review for supporting of this research of English case grammar that applied in the 4th semester student in the academic year 2018/2019 and these studies have been reviewed and the result of the previous studies as follows:

First, taken from Suparnis (2008) of his journal with the title is Case Grammar. He explained about the theoretical about English Case Grammar and made the structure of the sentences and examples to use of English Case Grammar. So, that is why finding a research about English Case Grammar for Student in the university.

Second, taken from Ye (2015) of her journal with the title is Case Grammar and its Application in English Vocabulary Teaching. By her research she explained about learning a foreign language, vocabulary learning is the very first step and also the basic step. Generally, the most common way for Chinese learners of English to learn vocabulary is through memorization their Chinese equivalents. As a result, they will encounter many words with the same Chinese meaning, which makes them confused. Based on her research, she researched about Chinese learners that want to learn English by using vocabulary of English case grammar. That is the second interesting to research about English case grammar to students that learning English in the level of university

For the theory of case grammar is taken from Fillmore (in Ye, 2015) which highlighted the fact that syntactic structure can be predicted by semantic participants. It focuses on the link between the number of subjects, objects and so on of a verb and the grammatical context it requires. The underlying structure of the syntactic and semantic relationships between nouns and verbs related with it is deep case. This kind of case doesn't have to be shown through the change of the morphology of nouns and pronouns. The case is determined based on the underlying structure of the syntactic and semantic relationships between nouns and verbs. Once these relationships have been determined, they are fixed; no matter what position they are in the surface structure, what grammatical relations they are with verbs. The case in the deep structure has no correspondence relationships with any particular language and grammar concepts in the surface structure, such as subject, object, etc. Fillmore in the beginning (1968) listed for case grammar are Agentive (A), Instrumental (I), Dative (D), Factitive (F), Locative (L), and Objective (O). But, he qualified again and include for the others is Benefactive (B), Time (T) dan Comitative (C). At last, he revised in 1969 his case grammar and omitted for Factitive (F). Case grammar is modification from generative transformation grammar which explained about argument and predicator in proposition (Kridalaksana, 2013). The listed of case grammar are

1) The agentive case is 'the case of the (typically animate) perceived instigator of the action identified by the verb. Example: Tom Pruned the roses, in this example Tom is agentive case

2) The dative case is 'the case of the (animate) being affected by the state or action identified by the verb. For example: John believed the story.

3) The instrumental case is 'the case of the inanimate force or object causally involved in the state or action identified by the verb'. For example: The hammer broke the window.

4) The objective case is 'the semantically most neutral case, the case of anything representable by a noun whose role in the action or state identified by the verb is identified by the semantic interpretation of the verb itself'. For example: John liked the movie.

5) The Factitive case is 'the case of the object or being resulting from the state or action identified by the verb, or understood as part of the meaning of the verb'. For example: John built a table

6) The locative case is "the case which identifies the place or spatial orientation of the state or action identified by the object". They are stative locative and directional locative. For example: The toys are in the box.

7) The comitative case is a grammatical case that denotes accompaniment. For example: The children are with Marry.

8) Benefactive is the one who benefits from an event or activity. For example: She opened the door for Tom.

9) Time is the time at which an object or event is located. For example: The meeting lasted an hour.

III. RESEARCH METHODS

This study based on the research of Fillmore (1968) about study of case grammar. The idea to create this research when researcher studying to get magister degree, and after that following for the research when teaching a language class in the university-level. For the methodology of this research is qualitative research. This research is done to the students in the 4th semester in the academic year 2018/2019 majoring in English Literature study program, Dhyana Pura University. There are 13 students for the sample of this research by finding their sentence and based on the case grammar itself. The 13 students here have background working in hotel and restaurant. In hotel and restaurant in Bali need also to learn about English grammar and of the research used English case grammar, when they interact to the guest from abroad.

Method of collecting data is done by observe the student and giving material of case grammar and give an activity by doing exercise to write case grammar from the students related to hotel and restaurant. The students gave free words about hotel and restaurant, and then made into sentence and the last correlated with case grammar. The data is analyzed by checked and made correction of the sentence.

IV. RESULT AND ANALYSIS

Fillmore's theory (In Cook, 1989) they are 9 case grammar Agentive, Dative, Instrumental, Objective, Locative, Factitive, Comitative, Benefactive and Time.

Related to the effectiveness for teaching the English case grammar is really important because from the research found of some students still need to learn about this case grammar. There are 2 students of 13 students need improvement to learn about English case grammar. However on this case grammar could make the students make sentences and improve their sentences.

The effectiveness to teach or practice about English grammar, for the case grammar found the sentence that student made the sentence related to 9 case grammars. The student learned and understood English grammar although need to learn again about this case grammar. In the class, to study English grammar the students get started from the 2nd semester and learn also for case grammar.

For the sentences of students have done for the activity in case grammar in 4th semester academic year 2018/2019 and the sentence related with hotel or restaurant related to case grammar.

A. Agentive.

Student's example: Fajar prepared the table.

Based on the Fillmore's theory, this sentence for Agentive described Fajar (a waiter) as a subject of the sentence.

B. Dative

Student's example: The knife was belonging to Prinata.

Based on Fillmore's theory, this sentence for Dative described Prinata (a chef) as an indirect object of the sentence.

C. Instrumental

Student's example: Krisma used her hand to make a cake.

Based on Fillmore's theory, this sentence for Instrumental described her hand as direct object from the word used.

D. Objective

Student's example: The guest looked in the glass.

Based on Fillmore's theory, this sentence for Objective and related of direct object from the action verb looked.

E. Locative

Student's example:

Stative Locative: The amenities are on the tables.

For Stative locative for the marker of the sentence is on (used state verb).

Directional Locative: The guest came from Australia.

For Directional locative for the marker of the sentence is from (used motion verb)

F. Factitive

Student's example: Ester made a delicious cake

Based on Fillmore's theory, this sentence is effected verb of object not for subject. The word made is effected

verb of object not for subject. In case, to cake not for the person.

G. Comitative

Student's example: Anggreni is with Indayani in the team.

Based on Fillmore's theory, Comitative is marker by with and expressed about accompaniment. This sentence explained comitative is marker by with Indayani, accompaniment with her friend.

H. Benefactive

Student's example: He did the cook for Utari.

Based on Fillmore's theory, Benefactive is doing something to someone and used preposition marker is for.

I. Time

Student's example: Sadani spent three hours to make a delicious cake in the kitchen restaurant.

Based on Fillmore's theory, Time indicates object or event is located. This sentence of verb used is spent (verb 2) and for time indicates the object is a delicious cake.

V. CONCLUSION AND RECOMMENDATION

This section of the conclusion of this research is from 13 students in the 4th semester academic year 2018/2019 majoring English study program Dhyana Pura only 3 students which need improving again for grammar especially for case grammar. For the result, there are 9 of English case grammar that can be improved in sentence related in hotel or restaurant; they are Agentive, Dative, Instrumental, Objective, Locative, Factitive, Comitative, Benefactive and Time. For recommendation, this case grammar can be used to teacher, lecture or tutor to improve their student's ability and it can be used for English specific purpose for teaching or learning. In the era 4.0, English grammar still needed to all of students in the university level especially the university that has based on hotel or tourism level because they will create as a manager in the hotel department. At least for student has familiar with writing and speaking. So that's why English can be learned in this level.

REFERENCES

- Cook, A. W. (1989). *Case grammar theory*. USA: Georgetown University Press.
- Fillmore, C. J. (1968). The Case for Case. In B. Emmon, & T. H. Robert (Eds.), *Universal in linguistics theory*. New York: Halt, Renhart and Winston.
- James, C. (1980). *Contrastive analysis*. Longman Group Ltd.
- Kridalaksana, H. (2013). *Kamus linguistik*. Jakarta : PT. Gramedia.
- Suparnis. (2008). Tata bahasa kasus (case grammar). *Journal of Pendidikan Bahasa, Sastra Dan Seni: Komposisi*, 8(2), 126-131.
- Ye, B. (2015). Case Grammar and its Application in English Vocabulary Teaching. Paper presented at *The International Conference on Applied Social Science Research (ICASSR)*.

Student Self-Disclosure through Instagram Posts to Enhance Classroom Interaction

Putu Chris Susanto
 Management Department
 Universitas Dhyana Pura
 Bali, Indonesia
 chris.susanto@undhirabali.ac.id

I Made Anditawan
 Management Department
 Universitas Dhyana Pura
 Bali, Indonesia
 mad.andityawan@gmail.com

Abstract—Self-disclosure has been widely researched as a way to enhance interactions in the classroom and to improve the overall learning experience. Student self-disclosure can be expressed through various media, one of which is social media. Instagram, an indisputably visual platform of social media interaction, has become immensely popular among Millennials and Gen Z-ers. This study aims to analyze the visual aspect of self-disclosing posts from 180 students in two universities in Bali Indonesia, under the Instagram hashtag of “#myworld”, conducted at the beginning of a semester term. Utilizing content analysis method employing two coders with substantial inter-rater reliability (Cohen Kappa > 0.61), the study finds that the typology of self-disclosure falls into three categories: descriptive, evaluative, and topical, with descriptive self-disclosure as the clear majority (82.8%). The themes emerging from the self-disclosing posts include (from the highest prevalence): family, friends, religion, hobby, self, significant other, things/possession, and work/study. Further qualitative inquiry reveals that self-disclosure through social media is perceived to have lower risk than direct, face-to-face disclosure. It has the potential to be used to get better acquainted to one another with lower perceived risk.

Keywords—self-disclosure, education, classroom interaction, social media, Instagram

I. INTRODUCTION

As a process of communication, self-disclosure occurs when one deliberately and voluntarily discloses information about herself to another (Jourard, 1971; Cozby, 1973; Yu, Hu, & Cheng, 2015; Jacob & Karibeeran, 2017). The nature of the shared information can be descriptive, evaluative, or topical; it may include thoughts, feelings, aspirations, goals, failures, activities, experiences, successes, fears, dreams, and preferences (Yu et al., 2015; Jacob & Karibeeran, 2017). Self-disclosure involves revealing significant information that would be otherwise unknown. It can be intrinsically rewarding as it fulfills fundamental needs for social connectedness (Tamir & Mitchell, 2012), while it can be unnerving as it involves significant risk related to one’s vulnerability as one gives up some degree of privacy and personal control by

disclosing significant information to others (Altman in Bazarova & Choi, 2014).

In the classroom, self-disclosure is crucial to improve student participation, to facilitate interaction, and to achieve the learning objectives (Harper & Harper, 2006). However, with the perceived-risk of vulnerability, particularly on the part of the students, educators must consider different ways to encourage student self-disclosure. Self-disclosure can be achieved not only through direct face-to-face interactions, but also through other medium, including online through social media. By using social media as a platform for early interaction self-disclosure, students can strategically utilize elective disclosure to reduce the perceived information risk, while meeting the desired goals of improved interaction and participation (Bazarova & Choi, 2014). The students can post their self-selected information online, typically visuals including photos and videos, and subsequently these postings can be discussed in the classroom. The potential for anonymity and indirectness can be comforting for some students, as opposed to the traditional direct classroom acts of self-disclosure.

One of the most popular social networking platforms among Millennial and Gen-Z students is Instagram, which differentiates itself from other Social Networking Sites (SNS) such as Facebook or Twitter due to the exclusively visual aspect of its sharing mechanism (Williamson, Stohlman, & Polinsky, 2017; Sagiyanto & Ardiyanti, 2018). Indonesia has one of the largest number of users on Instagram, at over 60 million, of which 89% are in the 18 to 34 age range and are accessing the platform at least once a week (Mailanto, 2016). As with other social media platform, Instagram has allowed self-disclosure to become habitual with less perceived risk. Platforms such as Instagram focus on users’ up-to-date online presence and blur the lines between the real and virtual worlds (Sagiyanto & Ardiyanti, 2018).

Separate studies have cited the benefits of online-based social networking platforms for self-disclosure (Harper & Harper, 2006; Ko & Kuo, 2009; Okdie, 2011; Tang & Wang, 2012; Kusyanti & Safitri, 2016; Sagiyanto & Ardiyanti, 2018). A study of bloggers reveals that self-disclosure through blogging can increase the participants’ (i.e. bloggers’) subjective well-being, as the activity can be seen as a way to accumulate social capital, improve social integration, increase interpersonal communication, and thus enhance the overall

subjective quality of life (Ko & Kuo, 2009). One study specifically exploring the benefits of blogging for student interaction suggests that online self-disclosure through blogging has the potential to become “zone of reflection” for students that is lacking in face-to-face classroom interaction (Harper & Harper, 2006).

Still, there are perceived risks posed by disclosing oneself online, including in social media. One study suggest that perceive risks related to self-consciousness and audience size are always present in self-disclosure, including if online platforms are used. Another study finds, however, that social media platform such as Instagram decrease the risks related to self-disclosure, as users perceive the security and privacy features provided as a safeguard for the images and videos they post—thus allowing them to enjoy the benefits of gaining “likes” and “comments” while maintaining the sense of control over their shared contents (Kusyanti & Safitri, 2016). Additionally, one study cites that Instagram specifically allows individuals who are otherwise introverts in real life to be able to better express themselves, particularly through self-disclosing online gallery of quotes to reveal descriptive as well as evaluative information Sagiyanto & Ardiyanti, 2018).

The current study seeks to analyze the visual aspect self-disclosing posts from 180 students in two universities in Bali Indonesia, under the Instagram hashtag of “#myworld”, conducted at the beginning of a semester term. It aims to understand the typology of the self-disclosure used by the students, the themes that emerge from the self-disclosing posts, and the perception of the students upon completing the online-based self-disclosure assignment as well as their reasoning in choosing certain typologies and themes in this online-based self-disclosure.

METHODOLOGY

The current study collected 180 self-disclosing Instagram posts from 180 students from two universities in Bali, Indonesia over a period of one month, purposefully in the beginning of the semester to allow the students and instructor to get better acquainted with one another through the use of online-based self-disclosure. The sampling used convenience-based method as the students are all enrolled in one of the author’s courses in Consumer Behavior and Entrepreneurship. Three Instagram posting activities was presented to the students as supplements to face-to-face activities using different hashtags, i.e., “#thisisme”, “#myworld”, and “#mybrand”. The instructor took careful steps to ensure that the students are unaware about the research related to the postings. Students were awarded full participatory points for each posting regardless of content and quality. The instructor also ensured that the students have a complete sense of freedom in the content and form of their postings, as long as they adhere to Instagram’s standards, not plagiarized, and follow a common sense of decency.

Of the three topics in the semester, this paper discusses the second topic (i.e., “#myworld”) as this topic was seen to have a wide-range of interpretation, and the students are deemed to have caught on to the assignment as they had already done one in the prior week (i.e., “#thisisme”). To allow students to explore and disclose “their worlds” was seen as an opportunity to better engage with the students and to get a sense of what was important in their lives. After the cut-off date, all the postings were downloaded using a third-party application that

allowed the authors to download all postings related to the given hashtag. In separate focus group discussions, one of the authors (the instructor in the courses) showed selected postings from the students and discussed the potential interpretations and intentions of those postings.

The authors collected, coded and categorized the data using Microsoft Excel separately. Upon categorizing the 180 postings into three typologies (i.e., descriptive, evaluative, and topical), inter-rater reliability (IRR) was conducted between the two authors as raters for each typology to arrive at Cohen’s Kappa. The authors also applied Chi squared analysis to ensure low probability of randomness in the results. The authors then analyzed the data based on the frequency of each typology (mutually exclusive of one another), and the general themes of the postings (including family, friends, religion, hobby, self, significant other, things/possession, work/study, which are not mutually exclusive. This means that one post can only be categorized into one of the three typologies, but can be contain more than one themes.

Subsequently, the students were asked to participate in focus group discussions for a qualitative inquiry on their perception and feedback regarding the assignment, the reasoning behind choosing one type of disclosure typology compared to others, as well as the reasoning behind posting a photo or video with a certain theme(s) compared to others.

FINDINGS

The findings are divided into two parts. Firstly, in order to analyze the self-disclosing visual posts, the authors devised together a mechanism to code the typography and the general themes of the students’ Instagram posts. The typography was based on the classification by Morton (in Harper & Harper, 2006): descriptive, evaluative, and topical. Descriptive self-disclosures are marked by contents that depict factual information (thoughts, experiences, activities, etc.), while evaluative self-disclosures depict feelings and judgments (including likes/dislikes, preferences, etc.), and topical self-disclosure involves discussions and depictions of sensitive topics such as sexual orientation, political stance, etc. (Chen, 2014; Suo, Hong, & Qian, 2008; Harper & Harper, 2006). Then, the coded datasets were processed using inter-rater reliability (IRR) measure for each of the three typology. As indicated in Table I, all three measurements yielded high IRR values (Cohen’s Kappa > 0.61, $p < 0.01$) and high degrees of percent agreement between the raters—i.e., the frequency of agreement between the raters on each observation, either both indicate that the observation meet the category or both indicate otherwise. The descriptive typology of self-disclosure resulted in Kohen’s Kappa value of 0.789 ($p < 0.01$). This denotes a high value of Inter-Rater Reliability. Similarly, the Kappa for evaluative typology was 0.726 and for topical typology was 0.822 ($p < 0.01$), all denoting a high degree of Inter-Rater Reliability. Percent agreement between the two raters were also high across all typologies (> 90%).

INTER-RATER RELIABILITY MEASURE (N=180)

Typology	Inter-Rater Reliability		
	Cohen's Kappa	Significance (p)	Percent Agreement
Descriptive	0.789	<0.01	92.2%
Evaluative	0.726	<0.01	95.6%
Topical	0.822	<0.01	97.8%

Subsequently, Chi square analysis was conducted to ensure low probability of randomness. The analysis resulted in a high degree of confidence that the findings were not random, and that the typologies differ significantly from the expected frequency ($\chi^2=329.624, df=1, p<0.01, n=180$). The study found that most of the students' Instagram-based self-disclosure were *descriptive* in nature (152 posts, 84.4% of all posts). The remaining two typologies were rarely used in the self-disclosing posts. *Evaluative* disclosure was used in 16 posts (8.9%), while *topical* disclosure only in 12 posts (6.7%).

Visual analysis on the self-disclosing Instagram posts categorizes the students' self-disclosing posts into nine distinct themes. The theme most often interpreted and thus disclosed as related to the students' worlds is "family", seen in 52.2% of the 180 posts. Whereas one post can only belong to one typology, the themes of the posts are not mutually exclusive—i.e. each post can belong to more than one themes. After the theme of "family", the general theme of "self" featuring the students themselves (including self-portrait or *selfie*) is the second most frequent theme in the posts. This theme is seen in 42.2% of all 180 posts. Interestingly, posts revolving or "featuring significant other" (e.g. boyfriends, girlfriends, or fiancé(e)s) are not listed as one of the top five themes related to the students' "#myworld" posts. The themes related to "friends", "hobby", and "religion" round up the top five themes most frequently used in this online self-disclosure assignment. The complete distribution of self-disclosure themes is shown in Table II. Samples of the Instagram posts with various visual themes are show in Fig. 1 – Fig. 6.

DISTRIBUTION OF THEMES IN STUDENTS' POSTINGS

Theme	Distribution in Instagram Posts	
	Frequency	Percentage
Family	94	52.2%
Self	76	42.2%
Friends	54	30.0%
Hobby	37	20.6%
Religion	29	16.1%
Things	28	15.6%
Significant other	20	11.1%
Work/study	16	8.9%
Abstraction	12	6.7%



Sample of Instagram Post with the theme "Family"



Sample of Instagram Post with the theme "Self"



Sample of Instagram Post with the theme "Friends"



Sample of Instagram Post with the theme "Hobby"



Sample of Instagram Post with the theme "Religion"



Sample of Instagram Post with the theme “Significant Other”

DISCUSSION

The findings in this study confirms the findings by Harper & Harper (2006), which discusses student self-disclosure using the medium of blogs. In online-based self-disclosure, most students tend to present new or expanded information about themselves that would or could have not been shared in class due to some limitations. Compared to other studies that use online blogs as the medium of indirect self-disclosure (Harper & Harper, 2006; Ko & Kuo, 2009; Okdie, 2011; Tang & Wang, 2012), the ability to mainly use visual elements in the current study, including photos and videos, in addition to texts in the form of captions is one key advantage of Instagram self-disclosure. Still, the patterns of disclosure favoring descriptive to evaluative and topical is consistent with the previous finding by Harper and Harper (2006). As participants noted in the focus group discussions, perceived risks are the primary driver for them to stick with the descriptive type of self-disclosure, favoring to disclose about activities and experiences rather than feelings and judgments about certain issues. As one student cited,

“...this is due to the “comment” feature in Instagram. I don’t want my friends to *bully* me if I post something too sensitive or opinionated.”

One encouraging finding from the focus group discussions relates to the benefits of this activity. Participants note that this activity allows them to reflect on what is really important in their life and what they are willing to deliberately disclose about their lives. Many classmates only know one another in class, and this activity has allowed them to see the things that are important, and perhaps previously unknown, about their colleagues including families, talents and hobbies. Secondly, some participants note that the activity is significantly less risky than, as one noted,

“...making a fool of myself by talking about myself, my family, and things about me that are important in front of the classroom. With Instagram, I can just post and forget about it.”

The focus group discussions strongly support the categorization and reasoning for the themes that emerged. As the focus of this self-disclosing Instagram post is not just about oneself but “one’s world”, most students interpret that their worlds revolve not only around them but also something else beyond them. As such, over half of the students depicted their families as their worlds. The portraits and videos related to self comes second, even so not many are exclusively of self-portraits (*selfie*). Most also relate to one’s relationship with nature or his/her surroundings, which again brings forth the idea of belonging to something larger than oneself. Additionally, themes of friendship and hobby are also often shared—in many cases the two are related. In fact, 7.2%

percent of all posts are marked for both the themes of friendship and hobby. An interesting finding is the relatively low frequency of posts related to significant other. Though many students are already in relationships, not many are willing to share about their significant others in this exercise. As one participant noted,

“There’s quite a bit of a risk related to sharing about your boyfriend/girlfriend. Since my classmates and my instructor will see my posts, along with others, I didn’t want to appear boastful about my relationships. That doesn’t mean significant other is not important for me; I’m just not comfortable sharing about them.”

Additionally, this online self-disclosure activity allows for reflection and gives an opportunity for students to interact with one another across platforms, sharing information that would otherwise be unknown to one another. Students tend to gravitate towards certain topic that would garner more “views” and “likes”, while avoiding negative “comments”. Encouragingly, students generally report positive experiences from this activity. Online self-disclosure allows all students, including ones who are less sanguine, to have an avenue to express themselves and share something about them with new friends and a new lecturer. This could potentially improve the students’ offline participation and classroom interaction.

CONCLUSION

Self-disclosure is an important avenue with which to improve student participation, to facilitate interaction, and to achieve the learning objectives—as previous studies have shown. The current study shows that student self-disclosure can be attained through social media interaction, one of which is through posting photos and videos on Instagram on certain topics that encourage self-disclosure. The findings from 180 self-disclosing Instagram posts from university students at the beginning of a new semester indicate that the majority of the students tend to disclose descriptive typology of visual posts, due to their lower perceived risk compared to evaluative and topical posts. Students are more willing to disclose their experiences and activities, compared to evaluative and topical typologies that are seen as having more perceived risked when shared with fellow students and the lecturer.

From the students’ visual posts related to the theme “#myworld”, several themes emerged in the Instagram images and videos, namely family, self, friends, hobbies, and religion as the top five recurring themes. These themes are also seen as having less perceived risk, compared to for instance sharing about activities with or affection towards a significant other. Students generally perceive this activity positively, as a way to interact with classmates and get to know one another better—using online social media as the platform with which to achieve out-of-class interaction. Using the Instagram posting as an activity in the beginning of the semester, subsequent classroom interaction can be enhanced due to the availability of the posts online and the opportunity to use cross-platform self-disclosure for the students.

REFERENCES

- Bazarova, N. N., & Choi, Y. H. (2014). Self-disclosure in social media: Extending the functional approach to disclosure motivations and characteristics on social network sites. *Journal of Communication*, 64(4). <https://doi.org/10.1111/jcom.12106>.

- Chen, B. (2014). Review on the self-disclosure of visitors. *Journal of Educational and Developmental Psychology*, 4(2), 94-101. DOI:10.5539/jedp.v4n2p94.
- Cozby, P. C. (1973). Self-disclosure: A literature review. *Psychological Bulletin*, 79(2), 73-91.
- Jacob, S. & Karibeeran, S. (2017, February). *Self disclosure among adolescence*. Conference paper of Adolescence: Getting it Right, Chennai.
- Harper, V. B., & Harper, E. J. (2006). Understanding student self-disclosure typology through blogging. *The Qualitative Report*, 11(2), 251-261. <https://nsuworks.nova.edu/tqr/vol11/iss2/3>
- Jourard, S. M. (1971). *Self-disclosure: An experimental analysis of the transparent self*. New York: Wiley-Interscience.
- Kp, HC & Kuo, FY. (2009). Can blogging enhance subjective well-being through self-disclosure? *Cyberpsychology, Behavior, and Social Networking*, 12(1), 75-79.
- Kusyanti, A. & Safitri, O. (2016). "How do I look": Self-disclosure of Instagram users in Indonesia. *Journal of Education and Social Sciences*, 5(2), 242-247.
- Mailanto, A. (2016, January 14). Pengguna Instagram di Indonesia terbanyak, mencapai 89%. *Okezone*. <https://techno.okezone.com/read/2016/01/14/207/1288332/penggunainstagram-di-indonesia-terbanyak-mencapai-89>.
- Okdie, B. M. (2011). *Blogging and self-disclosure: the role of anonymity, self-awareness, and perceived audience*. Dissertation University of Alabama. Retrieved from http://acumen.lib.ua.edu/content/u0015/0000001/000595/u0015_0000001_0000595.pdf
- Sagiyanto, A., & Ardiyanti, N. (2018). Self disclosure melalui media sosial Instagram (Studi kasus pada anggota Galeri Quote). *Nyimak Journal of Communication*, 2(1), 81-94.
- Suo, J., Hong, Z., & Qian, H. (2008). Research summary of self-disclosure in foreign countries. *Advances in Psychological Science*, 16(1), 114-123.
- Tamir, D. I., & Mitchell, J. P. (2012). Disclosing information about the self is intrinsically rewarding. *Proceedings of the National Academy of Sciences of the United States of America*, 109(21), 8038-8043. <https://doi.org/10.1073/pnas.1202129109>.
- Tang, J. H., & Wang, C. C. (2012). Self-disclosure among bloggers: re-examination of social penetration theory. *Cyberpsychology, Behavior and Social Networking*, 15(5), 245-250.
- Williamson, P., Stohlman, T., & Polinsky, H. (2017). Me, my 'selfie' and I: A survey of self-disclosure motivations on social media. *IAFOR Journal of Cultural Studies*, 2(2), 71-85.
- Yu, J., Hu, P.J., & Cheng, T.H. (2015). Role of affect in self-disclosure on social network websites: A test of two competing models. *Journal of Management Information Systems*, 32(2), 239-277.

Social Media and Translation: Analysis for Machine Translation Quality Assessment

Risa Mufliharsi

*Doctoral Degree of State University
of Jakarta*

*State University of Jakarta
Jakarta, Indonesia*

risa.mufliharsi@mahasiswa.unj.ac.id

Emzir

*Doctoral Degree of State
University of Jakarta*

*State University of Jakarta
Jakarta, Indonesia*

emzir.unj@unj.ac.id

Ratna Dewanti

*Doctoral Degree of State
University of Jakarta*

*State University of Jakarta
Jakarta, Indonesia*

ratnadewanti@unj.ac.id

Abstract—*Social media nowadays has been higher degree for getting information sharing, collaboration and community building. The information can be shared, disseminated and processed has presented potential issues that reflected social and political participation of social media users. Instagram- as one of social media explores many features, including automated translation. However, there are many paucities in meaning the text. To address the gap, this study examined and collated machine translation's result of Instagram automated translation and google translation which meaning of source taken in Indonesian gossip account in Instagram as social media's medium. The indicators of quality of translation were analyzed by error findings that adapted from Popovic (2018). There are five classifications used i.e. inflexional errors, reordering errors, omission, addition, and mistranslation. The result implied that grammar knowledge and crowdsourced used in machine had been better quality than Instagram's, (such as: tense, word order, etc.). Accordingly, it is necessary for Instagram as a rising social media need to improve its crowdsources.*

Keywords—*Instagram, machine translation, machine translation quality, social media, translation studies*

I. INTRODUCTION

Translation deals with cognitive complexity, technological action, explaining action, and rating output's quality. Furthermore, the impact visualizes complexity to search the idea of operational translation quality and measurable. Therefore, the definition of translation quality tries to catch the feature and interactions to design means of rating translation quality formally for a particular purpose.

Translation quality has become annual issues that discussed if dealt with machine translation. Castilho, Doherty, Gaspari, & Moorkens (2018) provided a critical summary of set up and expanding approach to definition and also measure human and machine translation quality workflows over distance of research, educational implication, and framework industry to be three typology that consists of three elements included i.e. human translation; machine translation; and human and machine

translation (Castilho, et al., 2018). It indicated that human translator still as a controller in assessing the quality of machine translation.

Nowadays, translation issues have developed into new paradigm, including to social media platform. Social media nowadays became 'new' trend interaction without limitation of area, time, and cost. People gather with social media platforms to get the latest news, gossip, or recent updates. That is an accepted reason why social media better has its automatic machine translation. Therefore, the challenge for translation in social media is how target language has equal meaning or got the communication's meaning from source language. The previous researches found the problems commonly were faced i.e. adequacy, fluency, overall quality, as well as rating cognitive post-editing efforts (Burchardt, Lommel, Bywood, Harris, & Popović, 2016). However, automatic tool cannot differentiate detail of error classes i.e. confusion of mistranslation, omissions, and additions.

Therefore, this research determines and assess the quality of Instagram automated machine and comparing with the quality of free neutral translation machine (Google's) through error classes which adapted from Popovic model. The indicators are used are inflexional errors; recording errors; omissions; additions; and lexical errors.

II. LITERATURE REVIEW

As seen before, social media has various platforms, generally internet based, that facilitate user's communication through a unique frame of reference. Besides, the social media can be called a procedure by which information and knowledge is rapidly shared. Various platforms of social media and also its use cause particular objectives (Roland, 2018).

In a way in starting and also encouraging many disciplinary dialogues, social media including Instagram is seen by three specific areas in exploring an on-going research project on the subject of translation and social media, such as: 1) the value of social media contextual that given by professional translators; 2) phenomena of self-translation on social media platforms; 3) the necessity of human intervention in translating new social languages i.e. the use of emoji, GIF. (Desjardins, 2016) it indicates that

use of social media increases intercultural studies that impact of descriptive framework influence that consisted by contextual research orientation for better understanding in context of using social media

One of social media that influenced Indonesian viewers is Instagram (Ganesha, 2017). Instagram recorded million active users every month in Indonesia. Data showed that Indonesian user grows 100 percent since last year. This condition confirms the general assumption that Indonesians are among active *Instagrammers*. It indicated that Indonesian people accessed many things from Instagram, including news accounts, which Indonesians popular accessed is a gossip account.

Gossip accounts are popular in Indonesia because the contents show activities including pictures or videos the newest and hottest news around celebrity's information. One of them is @lambe_turah. *Lambe Turah* had followers reaching up to 6 million people (14/01/2019) followers. In other words, the account is popular around Instagram's viewers. It caused by reading both accounts, people got easier to access any information that people wanted to know. As in Irawan's (2018) study, the information of the content must be validated by trusted information. The influence of the information brings confusion for viewers or let the viewers are still in question as some lies and incorrect news are put as if it is the truth. For this reason, this account is one of popular Indonesian gossip account in Instagram (Irawan, 2018).

Unfortunately, as public media, this account was read not only Indonesians, but also outside the country. The unique captions that found in accounts sometimes cannot be translated in English or wrong meanings if only analyzed without seeing the pictures related. The untranslated words themselves showed that accounts in delivering the news that would be the language choices of the accounts to make their reports different. But sometimes the words would be some problems to understand the content of the news itself, even there are translation machine that can be clicked under the captions. To solve the problems, this article will analyze the captions in @lambe_turah compared the results of their translation machine meanings both Instagram automated machine and google translation. This research aims in exposing comparison of both translation machine in translating with source language context-oriented choice that used in @lambe_turah will be compared the corpora by lexical knowledge (morphological tables, grammar rules, and lexicons) to check their clarity and accuracy in translating Indonesian text to English versions.

III. METHOD

A. Material of Analysis

The data were taken from captions both of original @lambe_turah and English version by translation machine of google translation and Instagram automated translation. The corpus scanned from April 6th – April 11th, 2019. The data examined and compared the result of machine translation of Instagram automated translation and google translation which meaning of source taken in Indonesian gossip account in Instagram as social media's medium. In order to do this, the data taken from Indonesian gossip account, then translated by Instagram's translation

machines and Google's. Next, the results compared by checking their clarity and accuracy in translating Indonesian text to English versions. On the other hand; it also explains how translation of news media paves the way for a partial interpretation in target language.

B. Procedure

In this research, the writer compared the output of translation automated quality from Instagram automated translation and google translation based on any duties and approach. The error categories (i.e. an error typology or taxonomy) should be clearly defined. This itself is a demanding task for several reasons: the errors should reflect all advantages and disadvantages of the MT system, which are important for the task at hand as well as for the languages involved; more detailed errors are more informative but more difficult to distinguish; and the error types should cover both linguistic aspects as well as translation aspects. Although there is some work in progress in this direction, there are still no general rules for defining error categories, even on a broad level. (Burchardt et al., 2016). The following subsection will present an overview of error typologies for manual classification used in the last decade (i.e. from the beginning until now) for different tasks, including analysis of post-editing action. Writer used particular of automatic error-classification judgement to be described in the next section adapted from Popovic (2018). (Popovic, 2018). Kinds the errors are: 1) inflectional errors, 2) reordering errors, 3) missing words (omissions), 4) extra words (additions), and 5) lexical errors (mistranslations).

FIGURE I

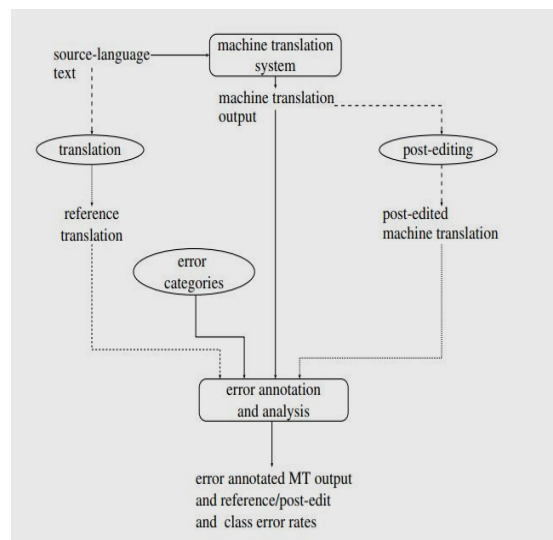

IV. RESULT AND ANALYSIS

Machine translation works well in events where the source and target languages are quite identical in terms of structure, morphology, concepts, etc. (Desjardin, 2017). However, it cannot be happened in social media context. The system should add availability of large amounts of parallel bilingual texts that are similar enough to the material that can be translated with respect to domain, text type, etc. So that, the systems must extract all of the relevant information. In this case, the errors are analysed into

inflectional errors; reordering errors; missing words (omissions); extra words (additions); and lexical errors (mistranslations).

Based on data recorded, there are 158 data that analysed based on the error types, here are the summaries of error types:

TABLE I

Automated Machine Translation	Error Types	Number s of Errors	Percent age	Total
Google Translation (neutral translation machine)	Inflectional Errors	6	3,79 %	32, 26 %
	Reordering Error	13	8,23 %	
	Missing Words (Omissions)	15	9,49 %	
	Extra Words (Additions)	8	5,06 %	
	Lexical Errors (Mistranslations)	9	5,69 %	
Instagram-Automated Machine	Inflectional Errors	22	13,92 %	67,74 %
	Reordering Error	18	11,39 %	
	Missing Words (Omissions)	14	8,86 %	
	Extra Words (Additions)	25	15,82 %	
	Lexical Errors (Mistranslations)	28	17,75 %	
				100 %

Here are samples of Google’s translation and Instagram automated machine based on @Lambe Turah news:

Based on news taken from @Lambe Turah captions. Here some of examples:

1. Source Language:

Ga tau yaa kalo anak sekolah jaman now hukuman nya apaan. (11/4/2011)

Google’s:

I don't know if the schoolboys are now punishments.

Instagram’s:

I don't know if the school kids nowadays what is the punishment.

Related to the data, there is an error in Instagram’s machine. The word school kids which reflected to plural. So, it should put are in there.

The error was classified into Inflectional errors. It refers to the change of form to describe the function of grammar or connect the tense, mood, person, number, case, and gender. The problems arose when the target language did not have the same grammar function with the source language. Besides, another problem also found because of lack of grammar ability. One of study as discussed by Lanoë, Vidal, Lubin, Houdé, & Borst (2016) that analysed children’s writing noun correctly. Besides, the inflection is also happened in other linguistic context learning verb i.e. when inhibiting overlearned and automatized strategies as the use of (-s) to indicate plural form. (Lanoë, Vidal, Lubin, Houdé, & Borst, 2016).

2. Source Language:

Ahhhh Siapa dia yaaa kira kiraaa. Ada lagi??? Ohh nooo. (10/4/2011)

Google’s:

Ahhhh. Who is she? There are more??? Ohh nooo.

Instagram’s:

Untranslated

It seemed that there was gap in transferring the equal meaning with source language. The data expressed natural spoken language so that MT cannot translate it well as seen in Instagram’s or wrong ordering as seen in Google’s. Google’s failed transferring Ada lagi?? which is interrogative form into English ordering correctly. Interrogative form in English should be “Is there any ??” (Auxiliary verb + Subject + Main Verb).

Overall, the patterns of Lambe Turah’s captions consisted by localization of Indonesian popular spoken language, so that there are some gaps that found based on reordering the sentence output of machine translations. The issue shows that the linguistic that adapted in social media platforms for new perspective is essentially based a form of localization. In other words, research on localization could be implemented in this context. Therefore, the topics surrounding how the platforms are translated might not produce recent concept. The second issue is concentrating on machine’s crowdsources of platform’s translation equally i.e iconographic language and natural language. (Desjardin, 2017)

In reordering error, it is related to check whether MT systems are still deficient when providing translations between languages with different word orders. Many reordering techniques can be used to solve the challenges and increase the translation accuracy. In this case, the source of language (Indonesian) word order was similar to that seen in the target language (i.e. English) based on the automatically learnt reordering rules from part of speech that tagged source language text.(Roy & Popowich, 2010).

V. CONCLUSION AND RECOMMENDATION

The As one of favorite content in Indonesia’s Instagram account is gossip account. @Lambe Turah is popular

account that consisted of celebrity information, commonly happened privately. Besides, the captions sometimes were not relevant with their posts. The language used are popular language in Indonesia. So that, there are many challenges in translating the captions even though had been translated automatically in its Instagram automated machine. There are also found some paucities also in neural translation machine (Google's).

Based on errors, the quality of google translation had higher improvement in inflectional errors, extra words, and lexical errors than Instagram's. It implied that grammar knowledge and crowdsourced used in machine had been better quality than Instagram's, (such as: tense, word order, etc.). It can translate by whole sentences and use broader context to help it figure out the most relevant translation. It quite suitable to translate Indonesian gossip account such as @Lambe Turah which its captions contained of Indonesian human speaking language. However, if it is seen from sociological perspectives, the crowdsource of google translation are too broad and sometimes are not fitted with the communication context. Whereas, social media reflects direct communication of people through online. This condition causes misunderstanding or misperception beyond social media users.

The suggestion referred to Instagram automated machine translation that still need improvement in provide and consider crowdsources and grammar language so that increasingly Instagram will be more popular platforms. Therefore, as popular platform, Instagram also need to develop the quality of its machine translation to eliminate misinterpretation, especially if it is related to features of instagram which is through pictures and video i.e. news content, social content, art content, literary content, visual content.

Overall, the patterns of Lambe Turah's captions consisted by localization of Indonesian popular spoken language, so that there are some gaps that found based on sentence output of machine translations. For next research, it is important for continuing machine translation quality research because it is needed for enhancing social networking for business expansion.

REFERENCES

- Burchardt, A., Lommel, A., Bywood, L., Harris, K., & Popović, M. (2016). Machine translation quality in an audiovisual context. *TargetTarget. International Journal of Translation Studies*, 28(2), 206–221. <https://doi.org/10.1075/target.28.2.03bur>
- Castilho, S., Doherty, S., Gaspari, F., & Moorkens, J. (2018). Approaches to Human and Machine Translation Quality Assessment, 9–38. https://doi.org/10.1007/978-3-319-91241-7_2
- Desjardin, R. (2017). *Palgrave Studies in Translating and Interpreting*. Canada: Palgrave Macmillan. <https://doi.org/10.1057/978-1-137-52255-9>
- Desjardins, R. (2016). Translation and Social Media. *Translation and Social Media*. <https://doi.org/10.1057/978-1-137-52255-9>
- Lanoë, C., Vidal, J., Lubin, A., Houdé, O., & Borst, G. (2016). Inhibitory control is needed to overcome written verb inflection errors: Evidence from a developmental negative priming study. *Cognitive Development*, 37, 18–27. <https://doi.org/10.1016/j.cogdev.2015.10.005>
- Popovic, M. (2018). Error Classification and Analysis for Machine Translation Quality Assessment. *Translation Quality Assessment, Machine Translation: Technologies and Applications 1, 1*, 129–158.
- Roy, M., & Popowich, F. (2010). Word reordering approaches for Bangla-English statistical machine translation. *Lecture Notes in Computer Science (Including Subseries Lecture Notes in Artificial Intelligence and Lecture Notes in Bioinformatics)*, 6085 LNAI, 282–285. https://doi.org/10.1007/978-3-642-13059-5_29

Teachers' Professional Learning through the Three-Pronged Approach: Teaching Innovation, Classroom Action Research, and Publication

Sri Rachmajanti
Universitas Negeri Malang
Malang, Indonesia
loekisr@gmail.com

Gunadi Harry Sulistyono
Universitas Negeri Malang
Malang, Indonesia
gunadi.hs@um.ac.id

Abstract— *With a view to quality teaching and learning, EFL teachers need to professionalize themselves upon their formal education at teacher colleges. A number of ways are open to teacher professionalism. This study is an exploratory survey to probe EFL teachers' views of EFL teachers at the lower secondary level of education on the areas for professional learning. A number of 455 EFL teachers of the lower secondary level of education are conveniently drawn from a number of towns as a sample of the present study representing experienced EFL teachers in East Java. A set of reliable questionnaires ($r = .633$) has been developed to collect data on their idea pertaining to aspects of developing innovative instruction, performing classroom action research, and writing research-based articles for publication. The results of the present study are discussed with respect to EFL teacher normative responsibilities and concepts on professional development. Pedagogical and theoretical implications of the findings are drawn with reference to the context of English teaching.*

Keywords— *development, EFL, learning, professional, teachers*

INTRODUCTION

The role of teachers in conducting effective class activities is undeniably of utmost importance for students' optimum learning. In a conceptual level, Harrison and Killion (2007); Keller (2011); Cox (2018) outline that teachers may contribute to effectiveness of their instruction as a resource provider, instructional specialist, curriculum specialist, classroom supporter, learning facilitator, mentor, school leader, data coach, catalyst for change, learner, a class controller, learning assessor, class manager, management stylist, resource person, participant, investigator, a role model, a substitute parent, class disciplinarian, counselor, bookkeeper, and a planner. Seen this way, teachers essentially play multiple-tasks the ultimate goal of which is students' optimum learning. In the national context, the importance of teachers' role is vividly reflected in the Law no. 14 year 2005 in terms of their competences – pedagogical, professional, social, and personal – and expertise with the aim of the achievement of the objective of the national education.

Considering the importance of teachers' role in the classroom, teachers need to update and qualify further their skills to impact students' learning better that is teachers need to always develop themselves professionally. The medium and the corridor within which teachers can qualify themselves is

commonly called professional development – PD (Archibald, Coggshall, Croft, & Goe, 2011; Darling-Hammond, Hyler, & Gardner, 2017). As teachers are expected to have the development throughout their career, such a professional development endeavor is also referred to as continuous professional development (CPD) or staff development, in-service training, professional learning, or continuing education (Mizell, 2010). Another term, the so-called professional learning (Calvert, 2016; Labone & Long, 2016) refers to more modernized conducts with interactive nature during the professional learning process. In this present article, the term professional learning is used throughout in the rest part of the article to mean any attempts made purposefully by teachers, be they individually or in group, in a formal or informal context, to always qualify themselves so as to make meaningful impacts on students' learning achievement.

To achieve professional learning, teachers may have choices of professional learning forms at their preference in so far as it is concerned with a teacher-student link, the ultimate objective of which is mainly twofold: improved teacher teaching effectiveness as reflected in student learning success and sustaining teacher professionalism throughout their career. However, Mizell (2010) argues that by the term professional learning, people have commonly associated it with formal activities with which teachers undergo. These may take the form like attending or presenting a paper in a conference, seminar, and a symposium, or joining a workshop; performing teachers' collaborative learning in a work team; or joining a course or pursuing further studies at a college or university. In a wide-ranging spectrum, professional learning can also refer to informal activities by teachers like mutually respectful discussions, independent reading and research, observations of a colleague's work, or other forms of learning from a peer. A broader and yet more conceptual notion of professional learning forms has obviously been reflected the normative framework of professional learning for teachers as adopted by the government of Scotland in which professional learning is seen naturally to be cyclical undergoing these segments: planning professional learning, engaging professional, impactful professional learning, evidence of impact, and professional dialogs (The General Teaching Council for Scotland, undated). In this scheme, sharing experiences in implementing teaching innovation upon joining professional learning activities seems to be a common view in Scotland practice; nevertheless it seems to be less practiced, not to say ever, elsewhere outside Scotland. In brief, professional learning offers to teachers a varied choice of means to make them more qualified in their teaching job, be they formally or

informally, which is planned and performed incessantly, and the result of the planning and implementation is reflected and then shared with colleagues.

Originating in Japan, one model of professional learning that has been widely adopted worldwide is lesson study (Cerbin, 2011; Lewis & Hurd, 2011; Hopkins, 2014). Lesson study refers to a different concept depending on the emphasis or focus. To Tsui and Law 2007 lesson study is research collectively conducted by teachers on most serious selected area of concern with the objective to enhance their teaching and their students' learning. More specifically, Dudley (2013) characterizes a lesson study as recurring cycles of planned actions in which small groups of teachers work collaboratively to solve identified areas of concern as empirical evidence of problems existing in their class. Then, they work together to develop a lesson plan as a 'research lesson' to address the problem. One teacher then conducts the teaching learning process based on the collaborative lesson plan they develop, while other teachers of the same group then make observations with a focus on what works on the students' learning and what does not. Following class observations, they discuss what they find it working or not working with the plan on students' learning activities during the teaching learning process, make reflections, and finally they learn lessons from input provided by an expert involved in the lesson study activity as a basis for them to improve their already implemented intervention (<https://tdtrust.org/what-is-lesson-study>).

This model of professional learning has demonstrated fruitful impacts in a number part of the globe. As reviewed by Cheung and Wong (2014), previous attempts to implement lesson study as a model of professional development conducted from 2000 to 2010 demonstrate empirical evidence of the benefits of lesson study in enhancing teachers' teaching role in the classroom and students learning. A study in primary and secondary schools in the UK by Godfrey, Seleznyov, Anders, Wollaston and Barrera-Pedemonte (2018) revealed a similar positive impact of lesson study as a form of professional learning on improvement of teachers' teaching conduct and students' learning.

In the existing literature, professional learning that particularly emphasizes more and aims to enhance teachers' professional learning through this three-pronged approach: their teaching innovation, implementation of the teaching innovation through CAR, and publication of their teaching innovation through CAR is still rarely conducted to date. While this three-pronged approach to professional learning is considered vital to professionalize teachers, thus far, the existing body of literature commonly has not addressed these three areas adequately: teachers' innovative teaching, CAR, and publication. Most literature commonly deals with classroom action research alone with a focus on planning, implementing, observing, and reflecting as suggested by scholars in favor of classroom action research (for instance Kemmis & McTaggart, 1992; Hopkins, 2014; McNiff, Lomax, & Whitehead, 1996). While this inquiry in the form of CAR to what works best as classroom pedagogy is useful for teachers to be more aware of uniqueness of their teaching practice, it is believed that no class is exactly similar in terms of teaching learning context, teachers taking this professional learning format tend to consign at a peripheral side. It is argued that those practitioners put a more focus on the completion of the cycles with which classroom action research is commonly

associated. As a result, although teachers opine positive impacts of conducting classroom action research in their professionalism (Bissonnette & Caprino, 2014; Yigit & Bagceci, 2017), they do not go beyond the steps of classroom action research to the other essential aspects of it. In other words, classroom research thus far has been not only incomprehensively but also inadequately conducted. It is undeniably argued that such inquiries result in providing teachers with valuable information about their practice. However, teachers have not yet departed further into 'more substantial and critical' (Burns, 1999. p. 13) practice with classroom action research. As a result, little is known about the best practice and innovation in their teaching practice as reports publishing their inquiry through classroom action research are still relatively few in number (Burns, 2005, p. 248). In Indonesian context in particular, this situation is due to the fact that they still encounter problems in conducting CAR (Burns & Rochsantiningsih, 2006). In other words, it is argued that teachers' innovative instructional planning and designs, implementation of the instructional planning and design in the form of classroom action research, and the publication of their classroom action research work as well as the dissemination of the results of their classroom action research through a seminar or a roundtable with colleagues and journal publication seem to be out of teachers' sight.

In the light of such a context, then it is desirable to reveal further empirical pictures on three important areas pertaining to teachers' attempt to professionalize themselves. This present study aims to examine these issues: In a geographical context of Indonesia, percentage of EFL teachers that have ever conducted CAR; whether they have ever written any articles for journal publication based on their CAR; their opinion about the need for them to present research results to colleagues; what motivates them to conduct CAR; benefits they think they will get in conducting CAR; and their confidence in conducting academic activities related to CAR.

LITERATURE REVIEW

Professional learning is a deliberate action taken to empower teachers' attributes in their profession so as to be more competent as a teacher (OECD, 2008: 19) implying that This also means that teachers are positioned in a dual role as both a learner and a practitioner (Schon, 1987). As learners, they are the ones of which qualification is being upgraded; and as practitioners, they are assumed to be an active participant in all professional activities set. Finally, professional learning is conducted beyond pre-service training activities. Thus, professional learning may take the form of in-service and on-service trainings.

Teacher professional learning aims at a number of objectives. Kowalchuk (1999) and Quint (2011) identify that teacher professional learning may be based on three paradigms: the technical-developmental perspective, the subject matter orientation, and ecological interpretation of learning to teach. Meanwhile, OECD (1998) specifies the area of concern of teacher development pertaining to hands-on classroom immediate needs. In the first place, teacher development serves as a medium for teachers to upgrade their internal traits in the subject-matter content, their teaching skills, their attitudes and approaches to teaching in line with the progress of teaching techniques and objectives, and new educational research. In addition, teacher development also

enables them to adapt and to implement instructional changes required in the curricular reforms by means of exchanging ideas among colleagues and experts. Finally, professional learning also enables instructionally low-performing teachers to be better professionally.

Professional learning for teachers may also embrace a wider scope of purposes. There are a number of forms of professional training aimed at improving teachers' knowledge and skills (<http://edglossary.org/professional-development/>), enabling teachers to use their analytical skills for identifying roots of learning problems on the students' part and using the results as a basis to align their teaching strategies with students' learning needs. Collaborative or interdisciplinary teaching provides the opportunities for English teachers to teach classes in teams with teachers from other disciplines as it happens in adjunct EFL teaching (Brinton, Snow, & Wesche, 1989) in which English teachers and content-area teachers team up carrying out instructional activities together. Professional learning also creates an opportunity for new teachers and experienced ones to interact for taking and giving constructive feedback. New teachers can learn from their senior teachers in a collegial mentoring scheme. A tandem teaching collaboration is a possible form of this activity.

A form of collaboration recently introduced to teachers aims at providing them with knowledge and skills in performing classroom action research. In such a training teachers learn how to professionalize themselves by identifying problems in their class, tracing the causes of the problems, developing rational teaching strategies to solve the problems, implementing the strategies, collecting evidence for what works and what does not work in implementing the strategies, and finally reflecting the results.

Effective professional learning programs are highly desirable; otherwise they are a waste of time and resources. However, not all professional learning programs are effective in equipping teachers with necessary competences needed in instructional context. In order to be operative in improving teachers' competences in their teaching job, several conditions are crucial. Richardson (2003) argues that the program is considered effective when it shares several features, four of which are worth noting. In the first place, it takes time. In addition, subsequent activities should follow, aiming at enhancing skills and knowledge introduced in the previous activities. Unlike the training for teachers is commonly carried out as a hit-and-run activity, effective professional learning program needs to be subsequently followed up with other ancillary activities once it is started. In addition to this, professional learning is not a matter of instructions from a master to a servant in which inequality of responsibility and power exists. It is the one in which power and responsibility is shared equally between the mentor and the trainees. That is, training activities need to promote collegiality. Teachers as trainees come with varied beliefs and practices in joining a professional training program. Meaning that professional trainings are not meant to make participants uniform in beliefs and practices. Considering that teacher beliefs play a vital tool in promoting educational practices (Borg, 2003; OECD 2008; Xu, 2012), professional learning needs to accommodate the existence of such different beliefs and practices. It is argued that appreciating differences in teachers' beliefs and practices is essential (Scott & Gani, 2016), the aim of which is to support educational reforms introduced to teachers that necessarily

come with perspectives different from the elements of the reforms. Finally, effective professional learning involves external mentors or facilitators. Teacher regular forums at a district level involve facilitators among teachers themselves who are considered to have more knowledge or skills. However, using external mentors or facilitators offers teachers several pluses. External mentors provide participants with different angles in dealing with an issue. In addition, external mentorships offer a sense of accompaniment to teachers in facing educational reforms. In addition, external mentoring enhances the growth of creativity on the parts of the teachers as reforms are offered from different perspectives (Dalton, 2015).

Why do teachers need to develop professionally in their teaching career? We can use several angles to respond to that question. Two are worth addressing here: students' side and teachers' perspective. On students' side, obviously students' learning needs to be of high quality while high quality learning stems from knowledgeable and skilled teachers with competent expertise. Furthermore, considering the crucial role of a teacher, students cannot grow appropriately in their English competences without sufficient facilitation of great teachers as Vygotsky (Walqui, 2006) has put it to theorize. Students – no matter their attributes are – in the hand of great teachers are with the right persons to learn better. These teachers will guide and take their students to their right learning needs for their lives. Students' learning needs also considerably differ from their era. For instance, Z generations differ in their learning needs from the needs of baby-boomers from which teachers come. Unless teachers make themselves adapted to their students' learning needs, teachers of a generation different from that of the students may encounter challenges that can hinder their teaching effectiveness.

On teachers' perspectives, learning is necessarily an everlasting process. So, when someone, including teachers, graduates from their education, it does not mean that they have to stop learning. They need to qualify themselves along the way in their profession upon graduation. Therefore, continuous learning let alone for teachers or anyone in professional occupations is inevitably crucial. In teacher professional development, teachers need to be aware themselves that they are in the position as learners. Secondly, although they get education from colleges with assumed functional sufficient knowledge and skills for future jobs, these competences are not sufficient for them to function properly in their new school jobs. 'No matter how good pre-service training for teachers is, it cannot be expected to prepare teachers for all the challenges they will face throughout their careers' (OECD, 2009). School teaching demands vary substantially from one place to another place, which college education cannot always meet completely. Thirdly, innovations for instance ICT use in the classrooms and advances in learning theories, as well as government policies change dynamically over time. All these mean that teachers should inescapably encounter. They need to deal with these changes by making themselves catch up with these changes properly.

Mizell (2010) exerts that teachers who do not get professional learning in their career will not expand their competences appropriately. When this happens, students will get the impacts as teachers will not satisfactorily meet their students' learning and their students' learning will seriously agonize ultimately. Several previous studies reviewed by

Marzano (2003) demonstrated that teacher professional learning conducted on important educational variables pertaining to teachers teaching aspects impacts positively on students' learning achievement. Similar findings are observed by Jackson and Bruegeman (2009). Considering these points described previously, therefore, teachers need further professional supports in their profession.

In fact, several teacher professional learning programs conceptually exist and are in use (Gaible & Burns, 2005, p. 25). In terms of the dispensation, the first model is the cascade model or the train-the-trainer model. In this model, selected competent teachers – probably master teachers - are trained at the central level. During the training of the trainers, their skills and knowledge from central training are then passed to the teachers at the next lower level and so on until they are trained to the teachers at the lowest level as the recipient of the educational innovation. The next model is the teacher-centered model. The focus of attention is on a teacher performance that becomes the object of learning. Under the teacher-centered model, Burns (2014) mentions five more models of teacher professional development:

Observation/Assessment, Open Classrooms, Lesson Study, Study Groups, Looking at Student Work (LSAW). Still, there are other models as viewed from the initiatives: standardized training, school-based training, and self-directed training. Apart from the types of professional training described previously, there are also other forms seen from praxis angles which Ling (2003) puts it to say as field experience-based training. These are 'the apprenticeship, professional, mentorship, and some modified models of professional-internship, inter-professional' (Ling, 2003, p. 14). Still another model the so-called 'reflective training' intended for sustainable EFL teacher professional learning discovered by Rachmajanti, Sulistyono and Suharyadi (2017) have practiced a framework of professional learning activities containing elements of teachers' application of knowledge, orientation to practicing and doing, active participation, reflection, self-actualization, and alignment to classroom activities using step-by-step delivery strategies in which collegial coaching, mentoring, collaborative teamwork, assessment and reflection, and flipped class activities are exerted.

In brief, professional learning programs come with varied models. The programs may be seen in general in terms of the modus of training delivery, the initiator, and the kind of learning experiences. Each model has their own aims; yet they overlap. In addition, these models also provide angles on which to synthesize and to make innovations on concepts for further training to envisage.

METHOD

Conforming to its objectives, the present study then employed a survey (Mathers, Fox, & Hunn, 2007). This survey involved a number of 454 respondents - 139 (30.6%) males and 315 (69.4%) females - representing the secondary level of education of English teachers in Indonesia. Of the respondents, 282 teachers (62.1%) were certified teachers and the rest – 172 teachers (37.9%) were not yet certified when the present study was conducted. Their teaching experience varied: 77 respondents (17%) had a range of teaching experiences from 0 to 5 years; 89 respondents (19.6%) taught English in the range of 6 -10 years; 152 teachers (33.5%) experienced teaching from a range of 11 to 15 years; and the rest – 136 teachers

(30%) taught English more than 16 years. The above data indicate that the respondents of the present study were already beyond the category of novice teachers (Michel, 2013). In addition, the majority of the respondent – 385 or 84.8% had a bachelor degree; and 68 (15.2%) hold a magister's degree of English Education Program.

Scrutinizing teachers' viewpoint pertaining to instruction innovation, research, and article publication is an attempt to reveal what teachers think - thinking attributes which naturally exist in their mind as a part of cognition, thus it is unobservable physically (Borg, 2009). A number of measurement techniques of unobservable thinking dimensions have been existent, starting from those involving invasive measurement procedures to non-invasive measurement ones of activity within the human brain in which a very sophisticated technology such as positron emission tomography (PET), functional magnetic resonance imaging (fMRI), and transcranial magnetic stimulation (TMS) (Driver, Haggard, & Shallice, 2007) may be utilized. Besides, other measures of non-observable existence of thinking processes are available: self-report, behavioral, and physiological (Price, Jhangiani, & Chiang, 2015). This present study employs an invasive strategy for the data collection method in which self-report measures in the form of a questionnaire (Mathers, Fox, & Hunn, 2007) are involved under the considerations that these methods of data collection offer a more number of advantages for the purpose of the present study, despite their constraints (Dubois, 2019).

The questionnaire used in the present study measures mainly respondents' evaluation on the need to share research results, their motivation to conduct classroom action research, their expected benefits of conducting classroom action research, and their self-efficacy to conduct classroom action research in which the respondents made their judgment on these main areas on a four-Likert scale with values ranging from 0 to 3 showing disagreement to agreement. The reliability of the questionnaire was 0.633 which was considered beyond sufficiency particularly for moderate stability of yielding scores, which is to show that the items are not only practically homogenous, but also has variance which is appropriately exclusive. Nevertheless, this variance is not necessarily correlated with each other in the set (Piedmont, 2014).

Quantitative descriptive statistical data analysis was exerted to the teachers' response to the questionnaire with a view to revealing the percentage of the frequency of the respondents' response on the respondents' evaluation on those four main variables.

IV. RESULTS AND ANALYSIS

Based on the result of statistical analysis, regarding their knowledge and practice of conducting action research, it was evident that about half of the respondents (54.4% or 247) had conducted CAR and the rest (45.6% or 207) did not. Pertinent to teacher research, most of them (96%) were of the opinion that there was a need to present the research results in a seminar to colleagues as well as to publish them in a journal due to such reasons as satisfying self-obligation to innovate teaching (100%), fulfilling official rank requirements (91.9%), and fulfilling government laws/regulation (97.8%). It is evident that teachers were aware, as part of their beliefs and practices, that they are to always learn to improve themselves by reflecting their ways of teaching through empirical studies. This claim is in line with the ideas propose by Borg (2003),

Marzano (2003), OECD (2008), Mizell (2010), Xu (2012), and Scott and Gani (2016). Moreover, the respondents realized that conducting such studies provides them more benefits for their career enhancement as well as for the students' betterment. The respondents' data on this matter is summarized in Table 1 underneath.

TABLE 1 BENEFITS OF CONDUCTING CAR

No	Areas of Benefits in Conducting CAR	Fully Agree		Agree		Disagree		Fully Disagree	
		f	%	f	%	f	%	f	%
1.	To Improve Teaching Practice	147	32.4	297	65.4	10	2.2	-	-
2.	To Provide Feedback on Teaching Weaknesses	195	43.0	256	56.4	2	.4	1	.2
3.	To Widen Perspectives in Teaching - Learning Practice	133	29.3	312	68.7	9	2.0	-	-
4.	To Enhance Confidence in Teaching	107	23.6	324	71.4	22	4.8	1	.2

Based on the results of statistical analysis in Table 1, it is discovered that all respondents agreed that conducting CAR will be to their benefit to improve teaching practice and widen perspectives in instructional practice. Moreover, most of them (99.7%) claim that doing research will provide feedback on teaching weaknesses, and enhance confidence in teaching. Observing these, it is then assumed that the teachers' beliefs and practices in professional learning do not always go congruent due to some obstacles as claimed by research conducted by Burns and Rochsantiningsih (2006).

With respect to the last variable, i.e., self-efficacy in doing research, it was found out that the respondents of the present study come up with different levels of confidence in the research areas as depicted in Table 2.

TABLE 2 SELF EFFICIENCY IN CONDUCTING CLASSROOM ACTION RESEARCH

No	Level of Confidence in Research Areas	Fully Agree		Agree		Disagree		Fully Disagree	
		f	%	f	%	F	%	f	%
1.	Conducting research as an academic responsibility	23	5.1	226	49.8	196	43.2	9	2.0
2.	Identifying research problems	33	7.3	236	52.0	183	40.3	2	.4
3.	Finding relevant literature sources	33	7.3	236	52.0	183	40.3	2	.4
4.	Selecting research designs	29	6.4	290	63.9	132	29.1	3	.7

The results of statistical analysis in Table 2 reveal that various levels of confidence appear in research areas in terms of academic responsibility, research problems, literature sources, research design, data analyses. As evidence, in the first place, the majority of the respondents (53.9%, the combined percentage of 5.1% and 49.8%) agreed that conducting CAR was part of academic responsibility as teachers, and the rest disagreed. In the second place, about identifying research problems and finding relevant literature sources while doing the research, most of them (59.3%, the combined percentage of 7.3% and 52.0%) felt confident but the rest lacked confidence. Next, for the research designs, the majority of them (70.3%, the combined percentage of 6.4% and 63.9%) opined that they were confident about selecting the designs, while the rest felt unconfident; finally, most of them (74.2%) agreed that they felt confident about analyzing data but the rest did not.

The results of data analysis on the respondents' experiences in writing journal articles for publication also reveal interesting findings. In general the data revealed that about half (54.2%) of the respondents did not have the experience in writing articles for journal publication. The data analysis on their level of confidence in becoming a presenter and writing articles for journal publication is summarized in Table 3.

TABLE 3 LEVEL OF CONFIDENCE IN DISSEMINATION OF RESEARCH RESULTS

No	Areas of Confidence in Dissemination of Research Results	Fully Agree		Agree		Disagree		Fully Disagree	
		F	%	f	%	F	%	f	%
1.	Unconfident in being a presenter in a seminar	31	6.8	204	44.9	208	45.8	11	2.4
2.	Confidence in article writing for journal publication	19	4.2	240	52.9	183	40.3	12	2.6

As shown in Table 3, only 48.2% of them (the combined percentage of 45.8% and 2.4%) stated that they were unconfident in presenting the research results to colleagues in a seminar; and lastly, dealing with article writing for journal publication, 57.1% of the respondents (the combined percentage of 6.8% and 44.9%) claimed that they were confident in the publication of an article in a journal but the rest were unconfident for article publication in a journal. Therefore, in order to scaffold those with low self-efficacy in research areas, Richardson (2003), Dalton (2015), and Rachmajanti et al. (2017) argue that any professional trainings are to be followed up by other step-by-step academic activities such monitoring, evaluating, supervising and mentoring or collaborative research work between teachers and mentors to be transformed into articles for publication for sharing best practices.

V. CONCLUSION AND RECOMMENDATIONS

In reference to the research findings and analysis, it can be concluded that in one hand, EFL teachers have evidently ever conducted CAR as, according to them, such research provides more benefits for themselves as teachers to be more professional as well as for the students' learning achievements. However, on the other hands, some of them have accomplished low self-efficacy to conduct academic activities related to CAR, and write articles for journal publication to share research results to colleagues.

Due to these, it is recommended for them to have such following actions as proactively inviting university teaching staff to train them how to conduct CAR (identifying research problems, finding relevant literature sources, selecting research designs and carrying out data analyses), and write a scientific article for journal publication. The article writing might be carried out through on-and-on mentoring until it is ready to be published; collaborating with peers to present the results of CAR in a seminar; and collaborating with a university tutor to publish a teacher research article for a journal publication.

ACKNOWLEDGMENTS

First of all, we would like to express our gratitude to the ICoELTICs committee for the publication. Also, our thanks is addressed to the in-service lower secondary school teachers who were willing to be the research subjects.

REFERENCES

Archibald, S., Coggshall, J. G., Croft, A., & Goe, L. (2011). High-quality professional development for all teachers: Effectively allocating resources. Research & Policy Brief. *National Comprehensive Center for Teacher Quality*. Retrieved on 2 April 2019 from <http://files.eric.ed.gov/fulltext/ED520732.pdf>.

Bissonnette, J. D., & Caprino, K. (2015). A look at ineffective and effective professional development: Moving toward action research. *Mid-Atlantic Education Review*, 2(1), 2328-3610.

Borg, S. (2003). Teacher cognition in language teaching: A review of research on what language teachers think, know, believe, and do. *Language Teaching*, 36(2), 81-109.

Borg, S. (2009). Introducing language teacher cognition. Retrieved on 29 March 2019 from

Brinton, D. M., Snow, M. A., & Wesche, M. B. (1989). *Content-based second language instruction*. New York: Newbury House.

Burns, A. (1999). *Collaborative action research for English language teachers*. Cambridge: Cambridge University Press.

Burns, A. (2005). Action research. In E. Hinkel (Ed.), *Handbook of Research in Second Language Teaching and Learning* (pp. 241-256). Mahwah, NJ: Lawrence Erlbaum Associates.

Burns, A. & Rochsantiningsih, D. (2006). Conducting action research in Indonesia: illustrations and implications. *Indonesian Journal of English Language Teaching*, 2(1), 21 – 35.

Calvert, L. (2016). *Moving from compliance to agency: What teachers need to make professional learning work*. Oxford, OH: Learning Forward and NCTAF.

Cerbin, B. (2011). *Lesson study: Using classroom inquiry to improve teaching and learning in higher education*. Sterling, VA: Stylus Publishing, LLC.

Cheung, W. M., & Wong, W. Y. (2014). "Does Lesson Study work?: A systematic review on the effects of Lesson Study and Learning Study on teachers and students", *International Journal for Lesson and Learning Studies*, 3(2), 137-149, .

Cox, J. (2018). "What Is the Role of a Teacher?" Retrieved on 12 March 2019 from Thought Co, Dec. 24, thoughtco.com/what-is-the-role-of-a-teacher-2081511.

Dalton, D. (2015). *6 Immediate Benefits of an External Mentor*. Accessed from <https://3plusinternational.com/2015/04/6-immediate-benefits-external-mentor/> on July 17, 2017.

Darling-Hammond, L., Hyler, M. E., & Gardner, M. (2017). Effective professional development. *Research brief*. Palo Alto, CA: Learning Policy Institute. Retrieved from Effective Teachers Development.

Debois, S. (2019). *Questionnaires* (Updated 2019). Retrieved [19 March 2019] from <https://surveyanyplace.com/questionnaire-pros-and-cons/>.

Driver, T. (2007). Introduction: Mental processes in the human brain. *Philosophical Transactions of the Royal Society B: Biological Sciences*, 362(1481), 757–760. doi:

Dudley, P. (2013) Teacher learning in lesson Study: What interaction level discourse analysis revealed about

- how teachers utilised imagination, tacit knowledge of teaching and fresh evidence of pupils learning, to develop practice knowledge and so enhance their pupils learning. *Teaching and Teacher Education*, 34(1), 107-121.
- Gaible, E., & Burns, M. (2005). Using Technology to Train Teachers [Online]. Available from info DEV: <http://www.infodev.org/en/Publication.13.html>. [Accessed on September 26, 2017]
- Godfrey, D., Seleznyov, S., Anders, J., Wollaston, N., & Barrera-Pedemonte, F. (2019). A developmental evaluation approach to lesson study: exploring the impact of lesson study. *Professional Development in Education*, 45(2), 325-340. DOI: <https://doi.org/10.1080/13632533.2019.1644444>
- Harrison, C., & Killion, J. (2007). Ten Roles for Teacher Leaders. *Teachers as Leaders*, 65(1), 74-77. Retrieved on 3 March 2019 from <http://www.ascd.org/publications/educational-leadership/sept07/vol65/num01/Ten-Roles-for-Teacher-Leaders.aspx>.
- Hopkins, D. (2014). *A teacher's guide to classroom research*. Berkshire: Open University Press - McGraw-Hill Education.
- Keller, T. (2011). *The various roles of the teacher in the English classroom*. Munich: GRIN Verlag. Retrieved on 9 March 2019 from <https://www.grin.com/document/319479>.
- Kemmis, S., & Mc Taggart, R. (1992). *The action research planner*. Victoria, Australia: Deakin University Press.
- Kowalchuk, E. A. (1999). Perceptions of practice: What art student teachers say they learn and need to know. *Studies in Art Education*, 41(1), 71-82.
- Labone, E., & Long, J. (2016). Features of effective professional learning: A case study of the implementation of a system-based professional learning model. *Professional Development in Education*, 42(1), 54-77.
- Lewis, C. & Hurd, J. (2011). *Lesson study step by step: How teacher learning communities improve instruction*. Portsmouth, NH: Heinemann.
- Ling, L. Y. (2003). Underpinnings of teachers' professional development- A new conceptualization of field experience. *Asia Pacific Education Review*. 4(1), 11-18.
- Marzano, R. J. (2003). *What works in school: Translating research into action*. Alexandria, VA: Association for Supervision and Curriculum Development.
- Mathers, N., Fox, N., & Hunn, A. (2007). *Surveys and Questionnaires*. The NIHR RDS for the East Midlands / Yorkshire & the Humber. Retrieved on 1 March 2019 from https://www.rds-yh.nihr.ac.uk/wp-content/uploads/2013/05/12_Surveys_and_Questionnaires_Revision_2009.pdf.
- McNiff, J., Lomax, P., & Whitehead, J. (1996). *You and your action research project*. New York: Routledge.
- Michel, H. A. (2013). *The First Five Years: Novice Teacher Beliefs, Experiences, and Commitment to the Profession*. An Unpublished dissertation submitted to University of California, Sandiego. Retrieved [11 March 2019] from <https://escholarship.org/uc/item/3cq6954m>.
- Mizell, H. (2010). *Why Professional Development Matters*. Learning Forward. Retrieved [1 April 2019] from www.learningforward.org.
- OECD (Organization for Economic Co-operation and Development). (2008). *TALIS 2008 technical report: Teaching and learning international survey* [PDF document]. Retrieved from <http://www.oecd.org/dataoecd/16/14/44978960.pdf> on June 23, 2017.
- Piedmont R. L. (2014). Inter-item Correlations. In: A. C. Michalos (Ed.), *Encyclopedia of quality of life and well-Being research*. Dordrecht: Springer.
- Price, P. C., Jhangiani, R., & Chiang, I-C.A. (2015). *Research methods in psychology. 2nd Canadian Edition*. a Creative Commons Attribution-Non Commercial-Share Alike 4.0 International License. Retrieved on 19 March 2019 from <https://opentextbc.ca/researchmethods/chapter/understanding-psychological-measurement/>.
- Quint, J. (2011). Professional Development for Teachers: What Two Rigorous Studies Tell Us. *MDRC Paper*. Accessed from www.mdrc.org on June 21, 2017.
- Rachmajanti, S., Sulisty, G. H., & Suharyadi. (2017). English Teacher Professional Development Training Practices: Lessons Learned from Indonesian Context. A paper presented in *ISOLEC 2017 – International Seminar on Language, Education, and Culture*. Universitas Negeri Malang: Malang.
- Richardson, V. (2003). The dilemmas of professional development. *Phi Delta Kappan*, 84(5), 401-406.
- Schon, D. A. (1987). *Educating the reflective practitioner*. San Francisco: Jossey Bass.
- Scott, D., & Gani, R. (2016). Engaging Student's Prior Knowledge in the Social Studies and History Classroom. Paper presented at *The Canadian Society for the Study of Education Annual Conference*. Calgary, AB.
- The General Teaching Council for Scotland. (n.d.). Retrieved on 19 March 2019 from <https://www.gtcs.org.uk/>.
- Tsui, A. B. M., & Law, D. Y. K. (2007). Learning as boundary-crossing in school-university partnerships. *Teaching and Teacher Education*, 23, 1289-1301.
- Walqui, A. (2006). Scaffolding instruction for English language learners: A conceptual framework. *The International Journal of Bilingual Education and Bilingualism*. 9(2), 159-180.
- Xu, L. (2012). The role of teachers' beliefs in the language teaching-Learning process. *Theory and Practice in Language Studies*, 2(7), 1397 - 1402.
- Yigit, C., & Bagceci, B. (2017). Teachers' opinions regarding the usage of action research in professional development. *Journal of Education and Training Studies* 5(2), 243 - 251.

TOEFL Practice Test Using UMY e-Learning and Schoology Mobile Application: A Comparison Study

Yashinta Farahsani

Department of Mechanical Engineering
Universitas Muhammadiyah Yogyakarta
Yogyakarta, Indonesia
yashinta_hime@yahoo.com

Muhammad Budi Nur Rahman

Department of Mechanical Engineering
Universitas Muhammadiyah Yogyakarta
Yogyakarta, Indonesia
budinurrahman@yahoo.co.id

Abstract—The development of education information system is now providing the access of learning resources for educators, education staff and students. One of the learning media that uses technology information is known as e-learning to facilitate the distribution of learning material, examinations, quiz exercises and assessments. UMY has an e-learning program that can be accessed in every faculty. This e-learning was created using social networking concept, so that it becomes one of the supporting communication tools between lecturers and students. In addition, Schoology has a similar concept to e-learning UMY. However, besides supporting online learning, Schoology provides a large selection of resources. The method used in this research was a qualitative method. The research subject was taken from UMY e-learning program and Schoology mobile application, and the research object was in the form of the practice test results in both programs. The technique of data collection was using documentation method. Documentation technique is used to find data about things that have been determined, by using this method, the writers can use free sentences. Both UMY e-learning and Schoology have advantages and disadvantages. The advantage of using UMY e-learning is that the students have got used in using UMY e-learning, while in using Schoology, the students can access it via the application. Although both UMY e-learning and Schoology need internet access, the students do not need to open the web to do the quiz and other academic activities. **Keywords**—TOEFL, UMY e-learning, Schoology, mobile application

I. INTRODUCTION

The Government of Indonesia encourages the development of education information systems based on technology and information to provide access of learning resources for educators, education staff and students (Government Regulation No. 17 of 2010, articles 48 and 59).

One of the learning media that uses technology information is known as e-learning. The main concept of the use of e-learning is to facilitate the distribution of learning material, examinations, quiz exercises and assessments. This is done through electronic media or internet, so students can access anywhere and anytime (Tigowati, 2017). With the use of e-learning, it is expected to improve student learning outcomes, functioning as supplement, complement, or substitute conventional learning according

to Siahaan's statement (Darmawan, 2014, in Tigowati, 2017).

Rahmawati (2016) in her research stated that the rapid development of ICT (Information, Communication, and Technology), Internet technologies, and Web-based applications has initiated some efforts in universities all around the world to implement e-learning strategies. Similarly, there has been a growing interest in developing an e-learning system in universities in Indonesian contexts. UMY has an e-learning program that can be accessed in every faculty. However, any definition of e-learning must settle the issue of what is and what is not e-learning (Guri-Rosenbilt, 2005, in Sangra, 2012). The discussion of the definition and practices of e-learning focuses on the intersection of education, teaching, and learning with ICT (Friesen, 2009, in Sangra, 2012). This e-learning was created using social networking concept, so that it becomes one of the supporting communication tools between lecturers and students. In supporting the online learning process, this UMY e-learning program is equipped with some learning activities, such as quizzes, assignments, as well as resources in the form of files and link. In addition, Schoology has a similar concept to UMY e-learning. However, besides supporting online learning, Schoology provides a large selection of resources, that accommodates the type of question (question bank), availability of attendance / attendance facilities, message and analytic. Besides that, Schoology uses different the course term (eye lessons) and groups (Amiroh, 2013).

The UMY e-learning program is a social network based on the environment of each faculty. This program provides a safe and easy way to connect and collaborate between students and teachers to share educational content, manage projects, assignments and handle notifications of every activity. UMY E-learning helps lecturers build a virtual class according to learning conditions in the classroom, based on the division of real classes in the study programs of each faculty, where in the class there are assignments, quizzes and assessment at the end of semester. The use of media online learning as a new learning system encourages organizing learning increasingly effective. As stated by Permana (2018) that using blended learning offers opportunity to place the students as the central of learning

process. In blended leaning environment, the teaching and learning process happens not only in classroom setting but also in virtual setting.

An innovative Schoology platform built on inspiration from Facebook (between face and model, fundamental aspects with the presence of posts, status updates, sharing and instant updating) and with that right goal to be a learning tool (Tigowati, 2017). Amiroh (2013) mentioned several advantages of Schoology including: a) Schoology provides more choice of resources. b) Schoology can accommodate question bank that will be used for quiz. c) Schoology provides attendant facilities for checking student attendance. d) Schoology also provides analytical facilities for viewing all student activities on each course, assignment, discussion and other activities prepared for students.

Various alternative of e-learning platforms which is used in learning causing confusion to choose. E-learning is able to provide positive improvement. Therefore, it is necessary to study about e-learning platform and comparative studies between platforms, namely E-learning UMY and Schoology. Both of these programs have similarities in terms of features namely the existence of assignment features, files and links, quizzes and gradebook. On the other hand, there are different features namely: Schoology has an attendance feature, analytic and can be downloaded in the form of a mobile application. That reason encourages to know the comparison to the second e-learning platform.

To do the TOEFL test, participants need to prepare. If they think that they do not know the tricks and tips in doing the test, usually the institutions have TOEFL Preparation program to help the participants improve their TOEFL score. Usually, the participants will attend the TOEFL preparation class for some meetings to study the tricks and tips to do TOEFL test. However, it will be difficult for the students who do not know about English at all, especially for grammar. It is because the structure skill is needed as the basic skill to learn TOEFL. The progress test is conducted to review the students' understanding and improvement. The test used to be conducted by UMY e- learning program, and now Schoology mobile application is used for the progress test.

Based on problem identification, then the problems in this study are:

- a. Are there differences in using UMY e- learning program and schoology towards cognitive learning outcomes in the TOEFL Practice Test?
- b. What are the factors influencing the students's result?

II. METHOD

The method used in this research is a qualitative method. In Ospina (2004), she compiled the definition of qualitative research method. Shank (2002) defines qualitative research as "a form of systematic empirical inquiry into meaning"(p. 5). By systematic he means "planned, ordered and public", following rules agreed upon by members of the qualitative research community. By empirical, he means that this type of inquiry is grounded in the world of experience. Inquiry

into meaning says researchers try to understand how others make sense of their experience. Denzin and Lincoln (2000) claim that qualitative research involves an interpretive and naturalistic approach: "This means that qualitative researchers study things in their natural settings, attempting to make sense of, or to interpret, phenomena in terms of the meanings people bring to them"(p. 3).

The research subject is taken from UMY e-learning program and Schoology mobile application, and the research object is in the form the practice test results in both programs. The technique of data collection is using documentation method. Documentation technique is used to find data about things that have been determined, by using this method, the writers can use free sentences.

The data collection technique starts from collecting data from test results by using documentation technique, then the writers analyze the data. After the analysis, the data are identified and classified according to the effectiveness of using those two programs. The instruments used in this research are laptop and cellphone. The data analysis is using discourse analysis.

III. RESULTS AND DISCUSSION

The TOEFL pre-test was using UMY e-learning to see the students' TOEFL score before they get the treatment. The test consisted of 3 (three) parts, they are listening, structures and written expressions, and reading comprehension. The duration of the test was set in each sections, listening was for 35 minutes, structures and written expressions was for 25 minutes, and reading comprehension was for 55 minutes. They did the test using computer, because it was easier rather than using cellphone. The audio for listening test used other device that did not include in e-learning. Therefore, the test needed operator to help conducted the test. Here are the steps how to do the test:

FIGURE 1. STEPS IN DOING TEST USING UMY E-LEARNING

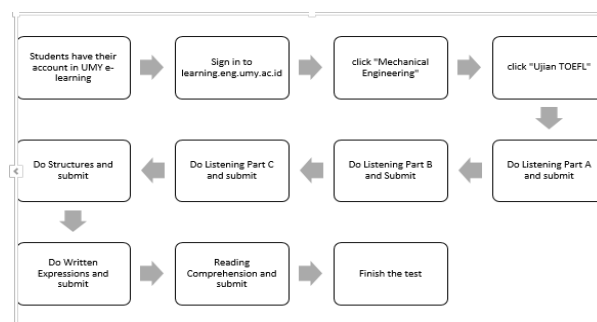

From the test that was conducted, here are the average of the test result when the researcher did the test for the 2015 students:

TABLE I. THE RESULTS OF TOEFL PRE-TEST USING UMY E- LEARNING

Skills Tested	Average Score	Converted Score
Listening Part A	6	
Listening Part B	2	
Listening Part C	4	37

Structures	5	
Written Expressions	7	36
Reading comprehension	20	40
Average score		377

After they did the pre-test, the Mechanical Engineering department conducts TOEFL Preparation Course as a treatment for the students improving their TOEFL score. The results of the test were announced manually since the TOEFL score was in the form of conversion from total correct answers of each skills (listening comprehension, structure and written expression, and reading comprehension). The treatment is conducted in a semester, with the total meeting is 16 meetings, consisting 13 meetings for delivering the materials, 2 meetings for progress test, and 1 meeting for post-test that is conducted in Language Training Center UMY in the form of TOEFL Paper-Based- Test.

During the treatment, students can download the materials via UMY e-learning that are provided each meeting. The materials consist of listening skills (skills 1-24) including the audio that can be downloaded, structures and written expressions (skills 1-60), and reading comprehension (skills 1-13). By downloading the materials via e-learning, the students do not need to copy the printed TOEFL book, because it will be costly.

The advantage of using UMY e-learning is that the students have got used in using UMY e-learning because almost all the subjects in UMY have been conducting blended learning (60% meeting in the class and 40% using e-learning). They have been familiar with the content and they find it easy to use because they can browse the website using both computer and cellphone. Therefore, they can do the assignment, quiz, download the materials anywhere and anytime.

In doing the progress test, Schoology mobile phone application is used as a tool for testing. The test consisted of 3 (three) parts, they are listening, structures and written expressions, and reading comprehension. The duration of the test was set in each sections, listening was for 35 minutes, structures and written expressions was for 25 minutes, and reading comprehension was for 55 minutes. They did the test using their mobile phone, and the students can operate by themselves. The audio for listening test is also set in the application, so they can listen while do the test. Therefore, the students can do the test independently. Here are the steps how to do the test:

FIGURE 2. THE PROCESS TO DO THE TEST IN SCHOOLGY

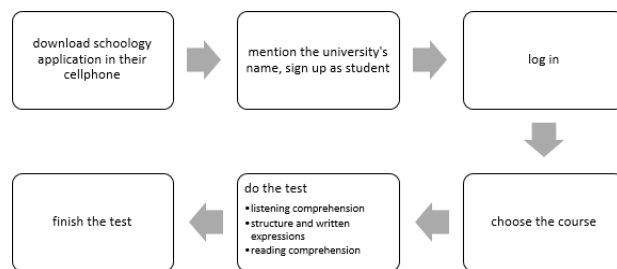

After the progress test conducted, here is the test result using Schoology application:

TABLE II. THE RESULT OF TOEFL PROGRESS TEST USING SCHOOLGY

Skills Tested	Average Score	Converted Score
Listening	11	35
Structures & Written Expression	9	31
Reading comprehension	8	28
Average score		313

The result shows that the students have less score when they use schoology application than when they did pre test using UMY e-learning. Therefore, the researcher can conclude that actually the usage of using the device and students' preparation are very needed before they do the test.

The advantage of using Schoology is that the students can access it via the application. Although both UMY e-learning and Schoology need internet access, the students do not need to open the web to do the quiz and other academic activities. They only need to download the application and everything is provided there. However, they are not familiar yet with this application, so they lack of interest in using it rather than using UMY e-learning.

According to Hendrastomo (2008) there are 4 components supporting the sustainability of e-learning in terms of infrastructure including internet access, hardware, software and access costs. The use of both UMY e-learning and Schoology is usually conducted out of the class, because the online activity is a kind of supplementary activity to support what they do in the class. The students can access in the campus using Wi-Fi so they do not need to pay. They can do it any time using their cellphone or laptop. Besides, the application both UMY e-learning and Schoology are free, so they do not need to pay when they register. It can improve their motivation in doing online learning.

If we compare between UMY e-learning and Schoology based program, both have good effects for the students. Since they live in digital world, they are more interested in studying through virtual class rather than actual class. Those applications make them more independent in learning, studying, submitting assignment, downloading materials, and doing quiz. Since the time is set up, they cannot submit

the assignment after the due date. That makes them more discipline because of the system. Karyawati and Ndadari in Tigowati (2017) state that by using Schoology, we can save time and money in delivering assignments, accessing learning resources easily, feeling new sources of learning and utilizing digital media to learn. However, UMY e-learning program is still more favorite for them than Schoology.

Since the students are limited by system, when they have virtual class, the UMY E-learning and Schoology have some disadvantages. For the assignment submission, they are limited by time for the deadline that makes them burdened. Sometimes, they are not interested to search some sources via internet because it means that they have to be always connected to the internet. When they have to do a quiz, especially for essay quiz, they have to type. However, students' tendency to copy-paste is increasing since they do virtual class. While in using Schoology, it is more practical because they do not need to use laptop. It is easier to access since it is in the form of application. Therefore, it improves students to learn and do the quiz any time and any where. The tools provided are also easy to understand and appropriate with the function. Students have an interest in using new learning media that is different from conventional learning. Students are more active learning in each task. Both e-learning programs foster students' attitudes more independently and each student does not have to interact directly with the teacher. In addition, the programs also make learning more interesting, and can increase knowledge because of the variety of resources provided.

The most important factors that influence the tests both using UMY e-learning and Schoology are students' preparation and their motivation in doing the test. Whatever tool the lecturer uses, if the students did not have enough preparation to do the test and they also did not have good motivation to improve their score, the result will be the same

This study uses a non-probability sampling using 16 children from TK X in Kamal. The population of this study were 16 children with saturated populations so that all children included in TK B were included in the treatment. The sample in this study used saturated samples by including all 16 children.

IV. CONCLUSION

It can be concluded that the use of e-learning in the class affects students' way of learning. The use of UMY e-learning and Schoology mobile application has significant differences, especially in the form of the application itself and the features. To access UMY e-learning, students have to be connected to the internet and browse learning.eng.omy.ac.id. In contrast, to access Schoology, the students only need to download it in their cellphone and they can use the application anytime. They are not constrained with the use of laptop. However, the use of UMY e-learning is still more popular than Schoology because it is the program from university that should be conducted in all of the majors in UMY. Living in digital world make the students are more interested in attending virtual class than actual class.

ACKNOWLEDGEMENT

This paper would not have been possible without the financial support from internal research grant program of LP3M. I am especially indebted to Mr. Fitroh Anugrah Y.K., S.T., M.Eng. who helped me to develop the Schoology mobile application, creating the quiz and inputting the questions. I am grateful to Mr. M. Budi Nur Rahman, S.T., M.Eng. who has become my partner in doing this research. All the lecturers in Department of Mechanical Engineering have provided me extensive personal and professional guidance and taught me a great deal about both scientific research and life in general. I would especially like to thank Mr. Berli Paripurna Kamiel, S.T., M.Eng. Sc., Ph.D. as the Head of Department of Mechanical Engineering. The last but not least, I would like to thank to my beloved family who always be by my side, my husband, my daughters, and my parents. You are always be the inspiration in my life.

REFERENCES

- Amiroh. (2013). Antara Moodle, Edmodo dan Schoology. Accessed on 10 January 2017, from <http://amiroh.web.id/antara-moodle-edmodo-dan-schoology>, 2 January 2013
- Darmawan, D. (2014). *Pengembangan e-learning teori dan desain*. Bandung: PT Remaja Rosdakarya.
- Denzin N., & Lincoln Y. (Eds.). (2000). *Handbook of qualitative research*. London: Sage Publication Inc.
- Hendrastomo, G. (2008). Dilema dan tantangan pembelajaran e-learning. *Majalah Ilmiah Pembelajaran*, 4(1), 32-35.
- Ospina, S. (2004). *Qualitative research in encyclopedia of leadership*. London: SAGE Publications.
- Permana, I. G. Y., & Sentosa, M. H. (2018). The Effect of Blended Learning with Schoology in Students' Writing. Unpublished.
- Rahmawati, F. (2016). E-learning implementation: It's opportunities and drawbacks perceived by EFL students. *Journal of Foreign Language, Teaching, and Learning*, 1 (1), 1-15.
- Republic of Indonesia Government Regulation Number 17 of 2010 concerning Management and Implementation of Education, No. 5105. State Secretariat. Jakarta.
- Sangra, A., Dimitrios V., & Nati C. (2012). Building on inclusive definition of e-learning: An approach to the conceptual framework. *The International Review of Research in Open and Distance Learning*, 13(2), 145-159.
- Shank, G. (2002). *Qualitative research: A personal skills approach*. New Jersey: Merrill Prentice Hall
- Tigowati, A. E., Cucuk W. B. (2017). "E- Learning berbasis Schoology dan Edmodo: Ditinjau dari motivasi dan hasil belajar siswa SMK", *50 Elinvo (Electronics, Informatics, and Vocational Education)*, 2(1), 49-58.

Design of E-Tourism System Batang Heaven of Asia as a Tourism Marketing

Ari Muhardono
Faculty of Economic
University of Pekalongan
Pekalongan, Indonesia
arimuhardono@unikal.ac.id

Danang Satrio
Faculty of Economic
University of Pekalongan
Pekalongan, Indonesia
danangsatrio3003@yahoo.com

Abstract— *The condition of the Kabupaten Batang is a combination of coastal areas, lowlands and mountains that have enormous potential for agro-industry, agrotourism and agribusiness. The southern part of Kabupaten Batang has the potential to be developed into a development area based on agro-industry and agro-tourism. However, the limited information makes tourism in Kabupaten Batang has not well known yet among tourists, so the number of tourist visits Kabupaten Batang has not experienced a significant increase, and even tends to decline. In achieving increased tourists' visits to Kabupaten Batang is needed for the use of information technology in the tourism sector, which is put in the form of electronic tourism, better known as E-Tourism. This research is a research and development research using the System Development Life Cycle (SDLC) methodology. This study aims to develop tourism destinations in Batang Heaven of Asia, through the Tourism Information System (E-Tourism) as a tourism promotion media. This study produced an E-Tourism design that can facilitate visitors / tourists in exploring tourist destinations in Kabupaten Batang, through this system, hotel bookings and ordering of souvenir products can be done online with the E-Commerce concept*

Keywords—*Kabupaten Batang, Batang Heaven of Asia, E-Tourism.*

I. INTRODUCTION

Kabupaten Batang introduces the slogan 'Heaven of Asia', calling for the tagline 'Visit Batang Year 2022, Heaven of Asia'. This new tagline seems to confirm that Kabupaten Batang deserves to be a tourist magnet in Asia. The condition of the region which is a combination of coastal areas, lowlands and mountains in Kabupaten Batang is a huge potential to develop regional development characterized by agro-industry. Agro-tourism and agribusiness. The southern part of Kabupaten Batang has the potential to be developed into a development area based on agro-industry and agro-tourism. This agroindustry base refers to various types of plantation crops such as: tea, coffee, chocolate and vegetables. In addition, it also has a prospective natural tourism potential in the future because Kabupaten Batang has two potentials at once, coastal and mountainous. Coastal with charming sea tourism as well as mountain tourism with a calm, comfortable and beautiful atmosphere.

In achieving increased tourist visits to Kabupaten Batang is needed for the use of information technology in the tourism sector, which is put in the form of electronic tourism, better known as E-Tourism. E-tourism is an application of information and communication technology in the tourism industry [1]. The description of e-tourism is a digitalization in

carrying out business processes and value chains in the tourism sector, namely travel agencies, hotels, hospital and culinary.

The design of E-Tourism-based tourism development emphasizes the online ordering system. This design basically provides a sufficient picture of how E-Tourism-based tourism development systems should work, and as a reference in the development of tourism in the future [2]. Maximum implementation of E-Tourism can be an effective means of marketing tourism [3]. The development of e-tourism-based tourism, emphasizes the online ordering system. This design basically provides a sufficient picture of how e-tourism-based tourism development systems should work, it is hoped that this system can become the backbone of tourism development in the future. Based on some of these studies, it is said that the use of technology has a significant impact on the tourism industry.

The difference in research that we did with the previous research was located on the object of research, and system output. At E-Tourism that will be developed here not only produces a tourism information system about tourist objects in Kabupaten Batang, but visitors can make hotel reservations and order souvenir products online by combining E-Tourism with E-Commerce.

A number of solutions have been proposed to improve the performance of e-business services for tourism consumers to buy tourism products and tourism services [9] but the problems that exist in the current system are that marketing is still not optimal. The information provided does not cover the tourism potential in the entire Kabupaten Batang, it is not interactive with tourists who want to get complete information about Indonesian tourism, and the information is only an object description of attractions, hotels, accommodations, but tourists cannot book accommodation and accommodation based the problem is, then the idea to maximize the use of IT in the tourism sector or often called e-tourism is to develop solutions to existing problems and put them into research entitled E-Tourism Design Trunk Heaven of Asia as Tourism Marketing Media.

Based on the formulation of the above problem, this study aims to design and develop tourism information systems (e-tourism) in the Batang Heaven of Asia as a media for tourism promotion in Kabupaten Batang. This research is expected to be able to develop knowledge in the field of marketing management and information systems especially about E-Tourism. For Kabupaten Batang, to be used as input material and consideration as a means of promoting tourism objects in Kabupaten Batang to be better known by tourists from outside.

II. LITERATURE REVIEW

A. Tourism

Tourism can be defined as something related to

Tourism has a big role in national development. Because in addition to generating income and also as a foreign exchange earner, the tourism sector is closely related to foreign investment [10]. According to Yulia [11] and Wibowo [12], tourism can be classified into several types: 1) Based on the time of visit it is divided into Seasonal Tourism or tourism based on seasons and Occasional Tourism or tourism based on events. 2) Based on the conveyance used it is divided into Air Tourism, Land Tourism and Sea or River Tourism. 3) Based on its geographical location divided into Local, Regional, National, Regional-International, and International Tourism. 4) Based on its influence on the balance of payments, it is classified into Tourism Inbound Tourism and Outbound. 5) Based on the number of people traveling it is divided into Individual Tourism and Group Tourism. 6) Based on the gender of tourists who carry out tourism activities are divided into Masculine Tourism and Feminine Tourism. 7) Based on price and social class divided into Deluxe Tourism, Middle Class Tourism, and Social Tourism. 8) Based on the age of tourists, it is divided into Youth Tourism and Adult Tourism. 9) Based on the purpose of the trip divided into Business Tourism, Leisure Tourism, and Tourism Education. 10) Based on the object divided into Cultural Tourism, Recreational Tourism or also called health tourism, Sport Tourism, Commercial Tourism and Religion Tourism.

B. E-Tourism

The Caribbean Tourism Organization (2005) provides definitions for the term E-Tourism, namely the use of information and communication technology to improve the use of tourism, provide various tourism services to customers, and make tourism marketing more accessible in the form of Telematics. In the opinion of [13] e-tourism is the maximum utilization of information and communication technology in tourism management so that the performance of the tourism industry is more effective and efficient.

Maximum implementation of E-Tourism can be an effective means of marketing tourism. The development of e-tourism-based tourism, emphasizes the online ordering system. This design basically provides a sufficient picture of how e-tourism-based tourism development systems should work, it is hoped that this system can become the backbone of tourism development in the future. E-tourism utilizes several features of information technology, such as tourism information databases, user databases, electronic payments, using computer networks as a means of shipping and service transactions, as part of e-commerce [14].

There are four main characteristics for developing an E-tourism, namely 1). tourism products, 2). chain impact caused by the tourism industry, 3). tourism industry structure, 4). availability of communication and information technology devices. In preparing E-Tourism characteristics, it is necessary to develop to achieve improvements in the electronic market such as existing system inheritance, diversity of information, no global standard for unlimited data exchange operations. The design of E-Tourism-based tourism development emphasizes the online ordering system. This design basically provides a

sufficient picture of how E-Tourism-based tourism development systems should work, and as a reference in tourism development in the future [16]

C. Tourism Marketing

Marketing is the whole system of business activities that aims to plan, determine prices, promote and distribute goods, services, and ideas to target markets in order to achieve organizational goals [17]. Tourism can be defined as something related to travel for recreation, tourism. Tourism can also be seen as a business that deals with the supply of goods or services for tourists and concerns every expenditure for tourists or visitors on their journey.

Tourism marketing is a system and coordination that must be carried out as a policy for tourism industry group companies, both private and government in the local, regional or international scope to achieve tourist satisfaction by gaining reasonable profits [18]. Tourism marketing further emphasizes who is actually a market segment and how it behaves [19]. The emphasis is on communicating to the market that the product offered (destination) is superior and different from other products. Tourism marketing is the implementation of improving the quality of tourism products in order to achieve the objectives of the tourism industry, to obtain tourist satisfaction so as to be able to attract larger and more sustainable markets [20]. Therefore, tourism marketing has an important role in increasing a country's tourism competitiveness as a tourism destination. To obtain tourist satisfaction, a destination in tourism marketing must understand the basic wants & needs and target behaviors of the target market [21].

III. METHODS

This study used a research and development design. This study aims to develop tourism destinations in *Kabupaten Batang* through a web-based Tourism Information System (E-Tourism). E-Tourism is intended for prospective tourists who want to know information on tourism, lodging, food, travel & tours in the *Kabupaten Batang* area. The methodology used for designing and developing this E-Tourism system is a structured methodology with the SDLC (System Development Life Cycle) model, which is broadly divided into the main activities, namely [22]:

1. System Planning Phase,
2. Analysis of System Analysis
3. Stage System Design
4. Program Design Phase
5. System Implementation and Testing

IV RESULT AND DISCUSSION

The proposed system is a Tourism Information System (E-Tourism) which contains: 1) Tourism News Information about Kabupaten Batang tourism. 2) Information on Tourism Objects which are divided into Nature Tourism, Cultural Tourism, Artificial Tourism, Culinary Tourism, and Religious Tourism which provide more complete information such as profitability, facilities, price of admission, location, available accommodation and others 3) Hotel Information, contains complete information about hotels in Kabupaten Batang (rooms, facilities, prices, location), visitors can also check the availability of rooms and book (reservation) hotels online. 4)

Travel Information, containing complete information about accommodation and travel in Kabupaten Batang. 5) Information for souvenirs, containing souvenir products in Kabupaten Batang, visitors can order these products online (e-commerce).

A. Process Design

The flow of the proposed system as a whole is described by the Context Diagram as shown in Figure 1 below:

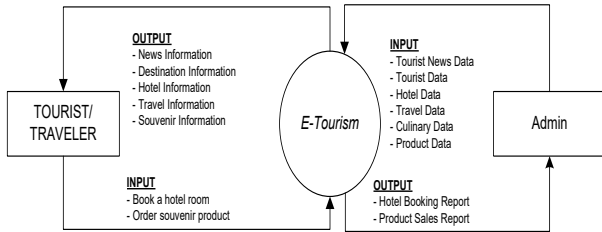

Figure 1. E-Tourism Context Diagram

From the Context Diagram above, in this process there are 2 (two) entities that interact, namely:

a. Traveler

- Input : Booking hotel rooms, ordering souvenir products
- Output : News information, attractions, hotels, travel and tours, culinary, online shop

b. Admin

- Input : Admin login, Tourism News Data, tourist attraction, hotel, travel, culinary, online shop
- Output : Reports such as hotel booking reports and online shop reports

The process flow of the system proposed in detail is described by the Data Flow Diagram as shown in Figure 2 below:

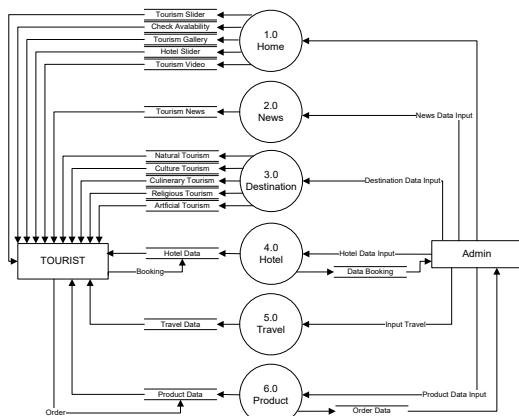

Figure 2. E-Tourism Flow Diagram Data

B. System Design (interface)

In this stage the system design will be built, the system input design includes the following displays:

a. Home page

The main form is the display of E-Tourism when it was first opened by Visitors, presenting summaries of E-Tourism information, namely:

1. Social Media, visitors can interact with social media such as Facebook, Twitter, YouTube, and Instagram belongs to the Public Relations of Kabupaten Batang
2. Tourist Slider, visitors are presented slider tourist attractions in the form of photos, tourist names, taglines that attract visitors. If interested in visitors can immediately click the visit button to go directly to the details of the attraction
3. Search for Hotels, visitors can immediately search for hotels, check availability of rooms by filling in the check-in date, check-out date, number of adult guests, children, click hotel check-up, hotels will be available according to the input
4. Photo Gallery, visitors can see photo galleries of tourist objects in Kabupaten Batang
5. Lodging Info, visitors can see information about lodging services in Kabupaten Batang
6. Tourism Profile Videos of Kabupaten Batang, visitors can enjoy watching the tourist profile videos of the Kabupaten Batang

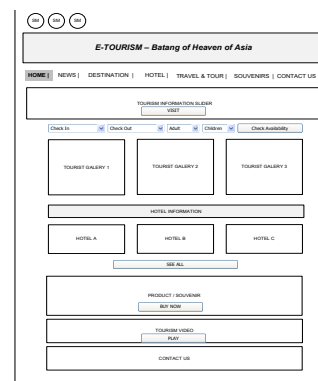

Figure 3 Main Page View Design (Home)

b. News page

On this page, information about news, articles about Kabupaten Batang is related to tourism, so visitors can update tourism information around Batang.

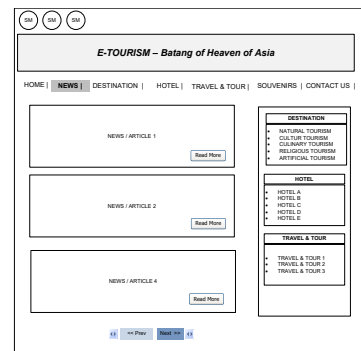

Figure 4. News Page

c. Tourist Page

On this page, information about tourism objects in Kabupaten Batang is divided into sub-categories: natural tourism, cultural tourism, religious tourism, and trunk tourism.

Visitors can see details about attractions by clicking Read More. Information presented such as tourist facilities, location, ticket prices, and others

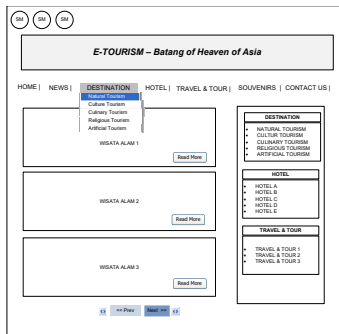

Figure 5 Tourist Page

d. Hotel page

On this page presented about hotel information in the Kabupaten Batang area, visitors can see details about the hotel by clicking Read More. Information presented such as hotel facilities, rooms, room prices, hotel location and others

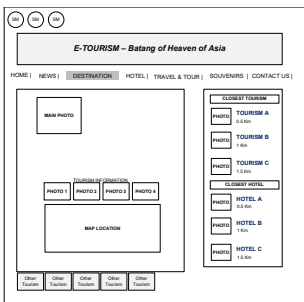

Figure 6 Hotel Page

e. Travel and Tour Pages

On this page, information on travel and tour accommodation in the Kabupaten Batang region is presented, visitors can see details about travel and tour accommodations by clicking Read More. Information presented such as travel facilities, advantages and prices

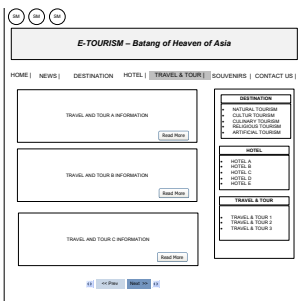

Figure 7 Travel and Tour Pages

g. Souvenir Products page

On this page it contains information on food products, souvenirs in Kabupaten Batang, allowing visitors to order / buy goods online.

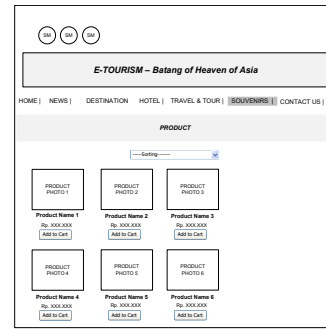

Figure 8 Souvenir Products page

C. Database Design

This stage is done by making database modeling. Database modeling is done by making data modeling using ERD (Entity Relationship Diagram) that shows the making of information, storage, and use of information in a business system.

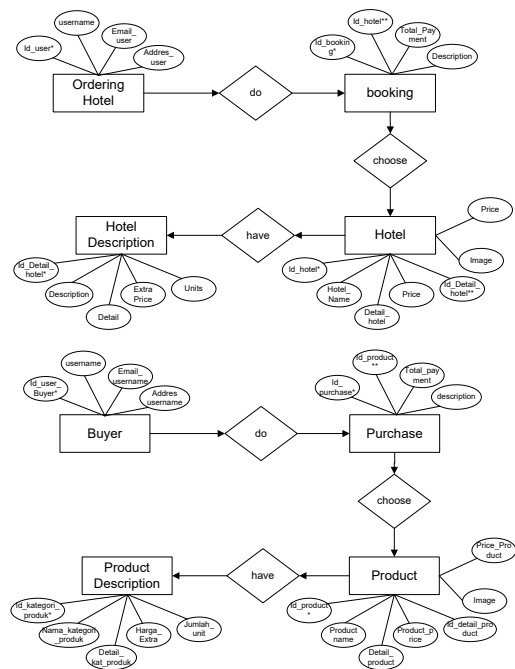

Figure 9 Database Design

D. System planning

Based on system analysis and system design that has been done, the next step is to change the design of process data and data modeling into programming languages. At this stage the software used is Notepad ++ for editing HTML, Wordpress Content Management System, Cascading Style Sheets, and MySQL Database

E. System Testing and Implementation

After the system design phase is implemented, the last stage is System Testing and System Implementation which aims to test the programs that have been made. The results of the testing and implementation of the E-Tourism Batang Heaven of Asia are as follows:

a. Home page

It is a menu display that was first accessed by visitors, the Home page contains information on social media services, tourism information, hotel search information, tourist galleries,

ordering products online. The display of the Home menu as shown in Figure 10. follows:



Figure 10. Home Page Views

a. News page

On this page, information about news, articles about Kabupaten Batang is related to tourism, so visitors can update tourism information around Batang. The system can function properly, visitors can choose the News menu then choose the news to be read. Display of News Pages like Figure 11

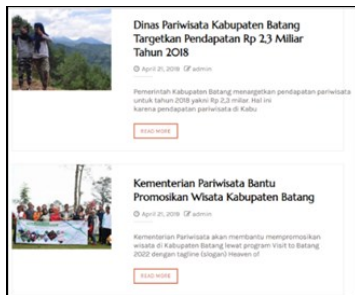

Figure 11. Display of News Pages

b. Tourist Page

On this page, information about tourism objects in Kabupaten Batang is divided into sub-categories: natural tourism, cultural tourism, religious tourism, and artificial tourism. Visitors can see details about attractions by clicking Read More. Information presented such as tourist facilities, location, ticket prices, and others. In this test the system can function properly, to display this page visitors can choose the tourist menu and choose the available tourist categories. Display of Page Objects as shown in Figure 12 below

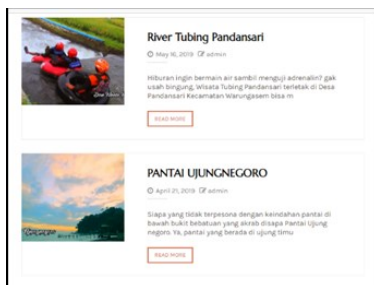

Figure 12. Display of Tourist Page

c. Hotel page

On this page presented about hotel information in the Kabupaten Batang area, visitors can see details about the hotel by clicking Read More. Information presented such as hotel facilities, rooms, room prices, hotel locations and others, in addition visitors can also book rooms online. In this test the

system can function properly from the start click the hotel details to the hotel reservation menu. Hotel Page Views as shown in Figure 13 below

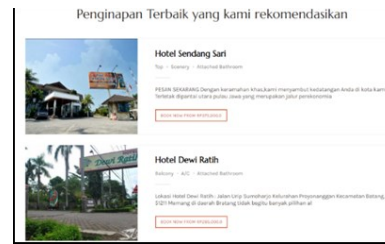

Figure 13. Display of Hotel Page

d. Travel and Tour Pages

On this page, information on travel and tour accommodation in the Kabupaten Batang region is presented, visitors can see details about travel and tour accommodations by clicking Read More. Information presented such as travel facilities, advantages, and prices, in testing this menu the system can function properly, visitors can select the Travel and Tour menu, as shown in Figure 14 below

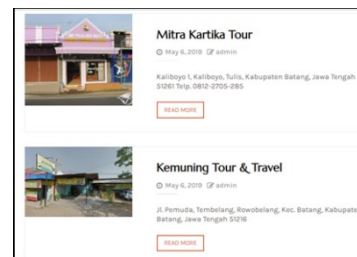

Figure 14. Display of Tour and Travel Pages

e. "Gift" Product Page

On this page, presented information about souvenir products in Kabupaten Batang, visitors can see product details souvenirs starting from product descriptions, product stock, product prices, product rating reviews, sorting products based on lowest prices, highest prices, and many products purchased. In addition, visitors can also order products online.

In this test, the system can function properly from starting to click product details, sorting the product to the product ordering menu online. To start shopping for souvenir products typical of Kabupaten Batang, visitors can choose the souvenir menu, then visitors can directly choose the product to be purchased by clicking "Add to Cart", the selected product will be displayed in detail, then click "View Cart "As shown in Figure 15 below

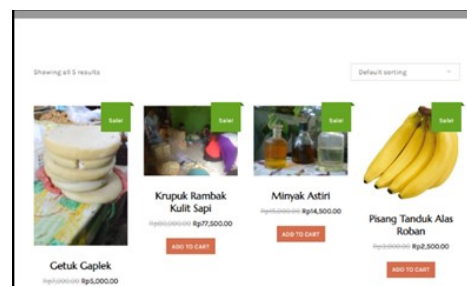

Figure 15. Product Page Display

CONCLUSION AND RECOMMENDATION

The E-Tourism prototype produced in this study can be used as a supporter of the *Kabupaten* Batang Tourism Media according to the tagline "Batang Heaven of Asia", so that tourism in the *Kabupaten* Batang is better known by outside tourists. E-Tourims Kabupaten Batang displays information about Travel Destinations, Lodging / Hotels, Travel and Tour Information, Souvenir Products, and other tourism information in Kabupaten Batang. E-Tourism makes it easy for tourists to visit Kabupaten Batang, this application not only displays tourist destination information, but hotel reservations and purchases of souvenir products online can be done. Suggestions from this study are that the application of e-tourism needs to be developed in accordance with the needs and development of technology in order to continue to support tourism promotion activities such as the use of technology Virtual Reality Tourism.

REFERENCES

- [15] Buhalis, D., & Jun, S. H. 2011. "E-tourism. contemporary tourism reviews"
- [16] Prantner K., Siorpaes K., Beachlechner., 2005, On Tour Semantic Web Search Assistant: Seminar on Semantic Web Technologies, Austria.
- [17] Tanaamah, A. R., Manuputty, A. D., 2006, Tourism-Based E-Tourism in Indonesia, Journal of Information Technology-AITI, Vol. 3 No. 1, February 2006
- [18] Prasetya.D &Rani. M. 2014 XDevelopment of Tourism Potential Sumenep District, Madura, East Java (Case Study: Lombang Beach) Young Political Journal, Vol. 3 No. 3, August-December 2014, 412-421 412
- [19] Yulia, C. 2008. Tourism, Tourism, Tourism and Tourists.
- [20] Wibowo, L. A. 2008. Tourism Services Business. Indonesian education university. Bandung.
- [21] Prantner K., Siorpaes K., Beachlechner., 2005, On Tour Semantic Web Search Assistant: Seminar on Semantic Web Technologies, Austria.
- [22] Zhang. J, "Tourism e-commerce business model innovation analysis" EBISS '09 International Conference, pp. 1-5, 2009.
- [23] Beatrice. S. 2013. The impact and perspectives of the e-tourism at a global level. Romanian Economic and Business Review – Special issue 2013
- [24] Prantner K., Siorpaes K., Beachlechner., 2005, On Tour Semantic Web Search Assistant: Seminar on Semantic Web Technologies, Austria.
- [25] Swastha, Basu. 2000 Principle of Marketing. Third Edition.. Liberty. Yogyakarta.
- [26] Utama, I. G. 2008. Extended Marketing Mix As a Strategy for Winning Senior Tourist Market Niches for Bali Tourism Destinations. Bali. Tourism S3 Program. Universitas Udayana.
- [27] Payangan, Otto, 2014. Marketing of Tourism Services. IPB Campus Taman Kencana: PT Publisher IPB Press.
- [28] Yoon, Y., & Uysal, M. 2005. An Examination of the Effects of Motivational and Satisfaction on Destinaion Loyalty : A Structural Model. Tourism Management.
- [29] Janri D. Manafe, Tuty Setyorini, Yermias A Alang. 2016 Tourism Marketing Through Natural, Arts and Cultural Object Promotion Strategies (Case Study on Rote Island NTT) Jurnal Bisnis dan Manajemen Islam
- [30] Ladjamudin.2005. Method of System Analysis and Design. Information, Graha Ilmu. Yogyakarta.

Cross-Cultural Counseling Module as the Creative Counselor's Attempt for Increasing Student's Empathy

Hardi Prasetiawan
Ahmad Dahlan University
Yogyakarta, Indonesia

Kusno Effendi
Ahmad Dahlan University
Yogyakarta, Indonesia

Bayu Selo Aji
Ahmad Dahlan University
Yogyakarta, Indonesia

Abstract. *Nowadays, there has been a paradigm shift in the guidance and counseling approach from traditional, remedial, clinical, and counselor-centered approach to development-oriented and preventive approach. One of counselors' creative attempt is by developing and establishing relationship with counseling through cross-cultural counseling where problems can be measured in terms of culture, ethnicity, and even gender. One of problems frequently occurs recently is the lack of empathy. Empathy is the ability to put ourselves in others, that we understand how other people feel, and what causes their reactions without being carried away by other people's emotion. School counselors' attempts in improving students' empathy is merely instructional aiming at students' cognitive aspect. Accordingly, in this 21st century, new counseling approach is needed, cross-cultural counseling. According to Paul Pedersen, cross-cultural approach is considered the fourth influential approach after psychodynamic, behavioral and humanistic approach. Cross-cultural counseling involves counselors and counselees with different cultural backgrounds, consequently, its process is prone to counselor's cultural biases resulting in ineffective counseling process.*

Keywords: *Cross Culture Counseling, Empathy*

I. INTRODUCTION

Education, according to Mu'in (2011), is an essential part of human life. First, education can be considered an unintentional or natural process. Second, it can be considered as a purposeful, planned, designed and organized process carried out based on the law, for instance, Act no. 20 of 2003 on National Education System, which becomes the basis of education. Guidance and Counseling is known as a service provided for students in school. Guidance and Counseling is a discipline in the field of human services. Fatur Rahman (2012) states that the primary purpose of school guidance and counseling is to provide support on personal maturity, social and academic skill leading to individual's career maturity which is expected to be useful in the future. Kamaluddin (2011) argues that school guidance and counseling is an attempt in assisting students to develop personal and social life, academic activity, as well as career planning and development. Guidance and Counseling service facilitates student's development in individual, group, and/or a classical

manner in accordance with students' needs, potential, talent, interest, development, condition, and opportunities. This service also assists students to overcome their weaknesses, hindrances, and problems they face.

According to Department of National Education /Depdiknas (in Caraka, 2015), nowadays, there has been a shift in guidance and counseling approach paradigm from traditional, remedial, clinical, and counselor-centered approach to development-oriented and preventive approach. Damaiyanti (2008) argues that one of the problems often issues recently is the lack of empathy. Eisenberg (in Panuntun, 2012) defines empathy as an affective response emerging from an understanding of an emotional state or other condition, and is similar to other's feeling. It can be concluded that empathy refers to an emotion to be engaged in feeling what other people are feeling without losing self-identity and attitude.

Farida (in Faizah, 2017) states that today's technology advancement does not only result in positive development but also negative development of children's empathy. This may unsharpen the children's sense of empathy since they are used to see or play with aspects of violence. Accordingly, various forms of violence emerge such as punching, shooting, or killing, and these are considered normal.

Based on the data from the National Commission of Child Protection (in Priiliawito & Ruqoyah, 2012), in 2012, the number of student's brawl show increase in the first six months. Until June, there had been 139 students' brawls in Jakarta, 12 of them results in death. While in 2011, there were 339 cases of students' brawl resulting in 82 students die. By seeing that data, school should not focus only on the transfer of knowledge, but also transfer of value. It will assist students in developing their characters, one of them is empathy.

School counselors' attempt in enhancing students' empathy was merely instructional aiming at students' cognitive aspect. This is in agreement with Koesoema (2012) who states that students are often demanded to develop only their cognitive aspect, however, they are lacked guidance in developing other aspects. Accordingly, in this 21st Century, a new counseling approach is needed, cross-cultural counseling. Cross-cultural approach is considered the fourth influential approach after psycho-dynamic, behavioral, and humanistic approach (Pedersen, in Supriana, 2009).

Supriadi (2001) argues that cross-cultural counseling involves counselor and counselee with different cultural background, therefore, the counseling process is at risk of cultural biases on counselors, leading to ineffective counseling. To have an effective counseling process, counselors must possess cultural awareness and release themselves from cultural biases, they must understand and capable of appreciating cultural diversity, and possess culturally responsive skills. Thus, counseling is seen as cultural encounter between a counselor and a client.

The study conducted by Iswari (2017) found that in order to make an effective counseling process, the counselor must possess cultural awareness and release themselves from cultural biases, they must understand and capable of appreciating cultural diversity, and possess culturally responsive skills. International communication in refers to activities occur among client's tradition, race, language, religion, educational status, social status, and gender. In addition, Suhartiwi & Musifuddin (2013) find that cross-cultural counseling needs practical methods or instrument, and synergy with client's cross-cultural needs.

Cross-cultural counseling carried out in schools universities, and society is aimed at obtaining goals and function of guidance and counseling, namely: the function of explanation, maintenance and development, prevention, and eradication, through the use of mode and format of counseling that covers all of sequence of counseling service such as : approach, counseling technique, type of service, field of service, supporting activities, and service format. Cross-cultural counselor refers to a counselor who always serves his/her clients in accordance with cultural characteristics, responsibility, and dedication towards their profession.

In this case, cross-cultural counseling to increasing empathy should be packed in a module by involving tenets emphasizing local culture' equality without neglecting the rights and existence of other cultures. Accordingly, the present study was conducted to develop a cross-cultural counseling module for increasing students' empathy in junior high schools in Yogyakarta City.

II. METHOD

The present study adopts the procedure proposed by Borg and Gall (in Sugiyono, 2012). In this case, the author employed model development in the form of adaptation of model adaptation from Sugiyono and Borg & Gall. The present study is also done only until the phase of preliminary field test, aiming at developing cross-cultural counseling module for increasing empathy.

The product being tested in the present study was a cross-cultural counseling module for increasing empathy. The design of product testing in this study was true experimental design for this design is characterized by the involvement of experimental and control group. The subject of the study was Junior High School students in Yogyakarta city. The present study employed true experimental design with random assignment (randomized pretest-and posttest with control group design based on Purwanto (2013). While, in order to collect the data, the present study employed instrument comprising three sections.

First, Interview guide. Second, Practitioners and Experts validation. Third, Psychological scale. The present

study employed qualitative and quantitative data analysis. The quantitative analysis was made by using independent t-test using SPSS 21 for Mac. The qualitative data analysis was done by categorizing qualitative data obtained from interview (responses, suggestion) and experts' and practitioners' criticism and suggestions.

III. RESULTS AND DISCUSSION

Basically, Module is a printed teaching material developed for students to be learned independently. According to Makmun (2006), module also emerges as a medium to learn independently because it is equipped with guide for autonomous learning. The characteristic of the module is consistent with the guide on writing module issued by Directorate of Vocational Secondary Education, Directorate of Elementary and Secondary Education, Department of National Education of 2003 (in Lestari, 2013) as follows: (1) *Self Instructional*, (2) *Self Contained*, (3) *Stand-alone*, (4) *Adaptive*, dan (5) *User Friendly*.

The module's components consist of: (1) introduction, (2) learning activity, and (3) references. Introduction covers (1) general explanation about module, (2) learning indicator. Learning activity includes (1) the detail of learning content, (2) summary, (3) test, (4) answer key, and (5) feedback. The module holds several advantages as follow: (1) Enhancing students' motivation, (2) assisting students achieve outcomes that are in line with their ability, (3) the learning material is distributed more equally in one semester, and (4) the education becomes more useful because it is designed in accordance with students' academic level.

Further, cross-cultural counseling refers to counseling carried out in different cultures. Locke (in Supriatna, 2009) states that cross-cultural counseling occurs when during a counseling process, there are cultural differences between counselor and counselee. Sue (in Supriatna, 2009) states that cross-cultural counseling refers to counseling provided to the minority groups such as black people, Hispanic, Indian, Asia-American. Based on experts' notion above, cross-cultural counseling refers to counseling involving counselors and counseling with different cultural background.

Regarding its activity, it is expected that counselor still applies principle similar to general counseling principles (Jumarin, in Effendi, 2013), those principles are: (1) The principle of confidentiality, (2) principle of volunteerism, (3) principle of openness, (4) principle of activity, (4) Principle of autonomy, (6) Principle of present (7) principle of integrativeness, (8) principle of dynamic, (9) principle of norm , (10) principle of expertise, and (11) principle of referral.

Anthropologists classify the forms of culture (cross-cultural counseling) into three (Effendi, 2013), namely: (1) idea, (2) activity, and (3) artifacts or products. The first form of cross-cultural counseling is culture in the form of ideas. The ideal form of culture refers to a set of ideas, notions, and values that is abstract in nature. This culture is intangible. The form of culture lies within a person's mind. When a person expresses his/her idea in a written form, then the culture stands in books or writing the person writes. In term of idea, culture is distinguished into two, namely: (1) overt / explicit idea, and (2) covert / implicit idea Explicit idea involves: (1) story, (2)

song, (3) *dolanan* songs, (4), traditional songs, (5) proverbs, (6) poem, (7) prose, and so forth.

The second form of cross-cultural counseling is activity/ action. Activity as the embodiment of culture refers to human behavior in communication. This form is often called "social system". Human behavior is distinguished into two, (1) verbal behavior, and (2) non-verbal behavior. Verbal behavior refers to behavior shown using language, either spoken, written, or sign language. While non-verbal behavior is shown by appearance exhibited by gestures.

The third form of cross-cultural counseling is product, it refers to the outcome of an individual's or group's work in a particular place that emerges as a characteristic and legacy of that people. The product of a culture may be diverse, for instance, (a) art, (b) traditional ceremony, (c) traditional clothes, (d) *wayang*, (e) *batik*/ handicraft, (f) traditional house, (g) foods, and so on.

The following discussion is related to empathy. Empathy is an English word for 'einführung', a word Dutch psychologist use. It literally refers to "Feeling into...". Term empathy is originated from the Greek word "phatos" added with prefix "in", referring to a deep and strong feeling that is close to misery.

Empathy is closely related to sympathy. However, they are different. While sympathy refers to sharing the same feeling, empathy refers to a deeper identification of personality toward someone so that a person who emphasizes temporarily lose him/herself.

Davis (in Taufik, 2012) defines empathy as "*a set of construct having to do with the responses of one individual to the experiences of another. These construct especially include the processes taking place within the observer and the affective and non-affective outcomes which result from those processes*".

Hoffman (in Gunawan, 2016) defines empathy as an individual's affective response for others, and it is adjusted to another person's situation rather than his/her situation him/herself. In this case, understanding affective refers to understanding someone's emotion or feeling. Empathy that is shown through communication functions as information to deliver what is being felt. Accordingly, it could be concluded that empathy refers to an individual's cognitive or affective response regarding another person's feeling, it is embodied in the form of pro-social behavior such as helping, entertaining, and trying to solve problems.

According to Eisenberg (in Panuntun, 2012), empathy holds two aspects, namely: (1) Affective aspect: It refers to someone's propensity to experience another person's feeling by sensing another person's feeling. (2) Cognitive aspect: It refers to intellectual process to understand another person's perspective and accept his/her perspective. Further, there are several factors influencing someone's fluency, namely: (1) Needs, (2) gender, (3) psychological maturity, (4) socialization, and (5) variation of situation and experience.

Therefore, in this case, the development of Cross-Cultural Counseling Module to increase student's empathy can be done by following manners: (1) Fully understanding emotion, more open someone toward his/her emotion, he/she will be more capable of reading other people' feeling. (2) Learning to listen to other people' opinion. (3) Paying

attention in the street, or other public places, and trying to understand their feeling through their facial expression. (4) Reputing other people not only based on their outer appearance. (5) Watching movies on TV and estimating the core of issues being discussed.

Then (6) Role play (7) Analyzing dissents. (8) Asking ourselves regarding our certain reaction toward certain conditions in order to see the background of our own behavior, this will be helpful to place ourselves in other people' situation. (9) Discovering the reasons within ourselves when we do not like someone. (10) Trying to seek information as much as possible about a person before judging someone, so that our judgment and attitude toward them can be more appropriate. (11) Remembering that every person is affected by his/her feeling and behavior.

IV. CONCLUSION

Developing a cross-cultural counseling module as a counselor's creative attempt for improving empathy can be a measure of school counselor's success in carrying out school counseling, individually or in group. In addition, school counselor can easily provide intervention towards the issue the students are experiencing, particularly the one involving empathy. The content of cross-cultural counseling module should cover materials that are capable of reducing cultural biases that become polemic in handling problems on students with different cultural background, ethnic, and religion.

REFERENCES

- [1] Bhakti, Caraka, Putra. (2015). Bimbingan dan Konseling Komprehensif dari Paradigma Menuju Aksi. Jurnal Fokus Konseling Volume 1 No. 2, Hlm. 93-106
- [2] Damaiyanti. (2008). Komunikasi Terapeutik Dalam Praktik Keperawatan. Jakarta: Salemba Medika.
- [3] Bhakti, Caraka, Putra. (2015). Bimbingan dan Konseling Komprehensif dari Paradigma Menuju Aksi. Jurnal Fokus Konseling Volume 1 No. 2, Hlm. 93-106
- [4] Damaiyanti. (2008). Komunikasi Terapeutik Dalam Praktik Keperawatan. Jakarta: Salemba Medika.
- [5] Effendi Kusno. (2013). Proses dan Keterampilan Konseling. Pustaka Pelajar: Yogyakarta.
- [6] Gunawan, I, M, S. (2016). Model Pewayangan Punakawan Suku Sasak Di Pulau Lombok Untuk Meningkatkan Empati Siswa. Jurnal Kependidikan Volume 15 Nomor 4.
- [7] Iswari, Mega. (2017). Efektivitas Penyelenggaraan Konseling dengan Memahami Komunikasi Antar Budaya. Jurnal Konselor Volume 6 Number 1.
- [8] Kamaluddin, H. (2011). "Bimbingan Dan Konseling Sekolah."
- [9] Koesoema. (2011). Pendidikan Karakter Strategi Mendidik Anak di Zaman Global. Jakarta: PT Gramedia.
- [10] Lestari, Ika. (2013). Pengembangan Bahan Ajar Berbasis Kompetensi: Sesuai dengan Kurikulum Tingkat Satuan Pendidikan. Padang: Akademia.
- [11] Makmun, Abin Syamsuddin. (2006). Psikologi Pendidikan (Perangkat Sistem Pengajaran Modul). PT. Remaja Rosdakarya: Bandung.

- [12] Mu'in, Fatchul. (2011). Pendidikan Karakter. Ar-Ruzz Media: Jogjakarta.
- [13] Panuntun, J. G. (2012). Hubungan Pola Asuh Orang Tua Dengan Empati Pada Siswa Kelas X SMK 3 Salatiga Tahun Pelajaran 2012/2013. Skripsi Fakultas Keguruan Dan Ilmu Pendidikan Universitas Kristen Saya Wacana, Salatiga
- [14] Piliawito, E & Ruqoyah, S. (2012). Sederet Awuran Pelajar di Jabodetabek Sejak Awal 2012. Konten ini diakses dari website <http://Metro.News.Viva.Co.Id/News/Rea D/354946-Sederet-Tawuran-Pelajar-Di-Jabodetabek-Sejak-Awal-2012>.
- [15] Purwanto, Edy. (2013). Metode Penelitian Kuantitatif. Fakultas Ilmu Pendidikan. Semarang : Universitas Negeri Semarang
- [16] Sugiyono. (2012). Metode Penelitian Pendidikan Pendekatan Kuantitatif, Kualitatif, dan R&D. Bandung: CV. Alfabeta.
- [17] Suhartiwi, S., & Musifuddin, M. (2013). Modus dan Format Pelaksanaan Pelayanan Konseling dalam Memahami Klien Lintas Budaya. Jurnal Konseling dan Pendidikan, 1(1), 73-82.
- [18] Supriadi, Dedi. (2001). Konseling Lintas Budaya: Isu-Isu Dan Relevansi di Indonesia. Universitas Pendidikan Indonesia: Bandung.
- [19] Supriatna, Mamat. (2009). Bimbingan Dan Konseling Lintas Budaya. Materi PLPG Sertifikasi Guru. PPB.FIP.UPI
- [20] Taufik (2012). Empati Pendekatan Psikologi Sosial. Jakarta: Raja Grafindo Persada
- [21] Undang-Undang Nomor 20 Tahun 2003 Sistem Pendidikan Nasional (Sisdiknas).

Study of The Existence of Retail Small Traders to Growth Modern Market in Labuhanbatu Regency, North Sumatera

1st Ade Parlaungan Nasution
Management
STIE Labuhan Batu
Rantauprapat, Indonesia
adenasution@gmail.com

2nd Pristiyono
Management
STIE Labuhan Batu
Rantauprapat, Indonesia
paktio16@gmail.com

3rd Denny Ammary Ramadhan
Business Management)
Gajah Mada University
Yogyakarta, Indonesia
dennyammari15@gmail.com

Abstract—*The purpose of this article empirically wants to examine the existence of traditional markets towards the growth of modern markets and provide solutions for traditional markets (small traders) to be able to compete with the existence of modern markets. In this study, the author tried to describe the events that became the center of research without giving special treatment to these events. This research is carried out around the community that is close to modern markets and not far away from traditional markets (Gelugur Market, Pasar Lama, Sigambal Market, and Aeknabara Market) in Labuhanbatu Regency in the period of four December 2018-March 2019. Data collection techniques of this research are interviews and field research using primary data (questionnaires) and secondary data (supporting). The sampling method uses probability sampling techniques, namely Simple random sampling is the simplest technique taken randomly, regardless of the level in the population. Samples are traders whose business location is 500 meters from the modern market or live directly receiving the impact of the modern market, amounting to 45 respondents. The conclusion of the results of this study is that the implementation of Government Regulations concerning the Establishment of Modern Markets should have been regulated by a Presidential Regulation No. 112 of 2007 and Permendagri No. 53 of 2008 was made as an effort to protect entrepreneurs, especially traditional traders, but in some areas it has not been effective. This is because the synchronization of central and regional policies has not been implemented properly about regional demographic constraints.*

Keywords — retail, small trader, modern market, economic growth, Labuhanbatu, government regulation

I. INTRODUCTION

At present, the growth of modern markets in various major cities in Indonesia has spread to remote areas at the district level. According to data from the Indonesian Market Traders Association (IKAPPI) between 2007-2011 or within a period of 4 years, the number of traditional markets dropped dramatically from 13,540 to 9,950 with the number of traditional market traders ranging from 12,625,000 people, according to 2011 Ministry of Commerce data from 9,950 traditional markets 3,800 of them have disappeared. These data reflect the position of traditional markets in people's lives, increasingly worrisome for small traders, plus the current traditional market has slowed down by 8.1% while the modern market has grown by 31.4%[1].

A distinctive feature of traditional markets is that they are physically close to people's lives or residences that depict a thick and harmonious social life where buyers and sellers feel closer because of repeated and deep interactions with natural

competitive advantages. The role of traditional markets is very helpful for the lives of small people who depend their lives on trading activities because in traditional markets many actors have important meaning and try to prosper their lives, be it traders, buyers, pelvic workers, regional or central government[2]

Instead, the modern market in transactions between sellers and buyers does not need to be done directly or face to face, but the buyer is enough to come and see the price tag on the goods to be purchased. All of these activities are carried out in buildings or buildings with all their services independently by salespeople. Modern markets generally sell products that have an expiration, while traditional markets as we now sell all kinds of goods that are limited and varied.

A “supermarket revolution” has occurred in developing countries in the past 2 decades. We focus on three specific issues that reflect the impact of this revolution, particularly in Asia: continuity in transformation, innovation in transformation, and unique development strategies. First, the record shows that the rapid growth observed in the early 2000s in China, Indonesia, Malaysia, and Thailand has continued, and the “newcomers”—India and Vietnam—have grown even faster[3]

The complexity of business competition between traditional markets and modern markets in the Labuhanbatu Regency has caused traditional markets or small traders to be increasingly powerless to accept the presence of modern markets. This requires traditional markets to be more creative and wise in facing reality to be able to compete healthily with the modern market[4]

Although the Government has made policies and regulations contained in the Presidential Regulation No. 112 of 2007 and Permendagri 53/M-DAG/PER/12/2008, n.d. which regulates modern markets and traditional markets. However, in reality, the regulation is not implemented properly. Many regulations are not obeyed by the founders of modern markets, such as licensing issues, the distance that is too close to traditional markets, the provision of business places for small traders[5].

The purpose of this article empirically wants to examine the existence of traditional markets towards the growth of modern markets and provide solutions for traditional markets (small traders) to be able to compete with the existence of modern markets.

II. LITERATURE REVIEW

A. Traditional Market Concept

The history of the establishment of traditional markets is a meeting place between sellers (traders) and buyers (society), wherein there is a natural social interaction where sellers want to exchange their goods with a certain amount of money, otherwise, the buyer wants to exchange money for goods or services. However, with the advancement of science and technology, the development and empowerment of traditional markets are now being built and managed by the Government so that traders and communities are more flexible and orderly. Local, private, and state-owned enterprises and regional government-owned enterprises, including cooperation with the private sector with businesses in the form of shops, kiosks, and tents owned/managed by small, medium-sized, community-based traders or cooperatives with small-scale businesses, capital small and with the process of buying and selling merchandise through bargaining[6].

Traditional markets are a form of retail business that involves many small scale traders. Buildings in traditional markets are relatively simple, consisting of stalls, booths, as well as tents for selling with a relatively less pleasant atmosphere (narrow business space, inadequate parking facilities, lack of maintaining market cleanliness and poor lighting). is a daily necessity, the price of goods traded is relatively cheap with less attention to quality and the way buyers are bargained in. Traditional market conditions are less developed and tend to remain without much change from time to time. inherent in traditional markets, uncertain prices, incomplete goods cause traditional markets to lose buyers, but traditional markets still have advantages, namely in terms of interaction and social communication where there is intimacy between sellers and buyers, sellers know consumers well[7].

B. Modern Market Concept

Modern markets began to develop in Indonesia in the 1970s, but are still concentrated in big cities. However, since 1998 the development of modern markets has grown along with the entry of foreign investment in the retail business sector. Modern markets are starting to develop into small cities to find customers. Modern markets are retail business sectors, so modern markets can be referred to as modern retailers or modern stores. In [8], modern stores are shops with self-service systems, selling various types of goods in retail in the form of minimarkets, supermarkets, department stores, hypermarkets, or wholesalers in the form of grocers.

Modern markets are markets that are managed with modern management, generally found in urban areas, as providers of goods and services with good quality and service to consumers (generally community members Middle-up class)[9]. Modern markets include shopping malls, supermarkets, department stores, shopping centers, franchises, supermarkets, supermarkets, and so on. This means that the modern market is a modern managed market, the sale of goods is done at the right price and own service. Modern markets have a comfortable place with a variety of adequate facilities.

The phenomenon of the modern retail market has emerged throughout Asia, South America, Eastern Europe, and the Middle East, especially where food retailing is dominated by traditional format family-run food stores. There is a trend in the expansion of modern grocery retailing as hypermarkets and

supermarkets. They are becoming increasingly popular by providing more convenience, a wider variety of products ranging from packaged and processed to fresh food products that consumers find at a wet market. While independent shops and mom-and-pop stores still dominate much of the region modern retail formats and chain stores are making inroads in urban areas of most Asian countries.

III. RESEARCH METHODS

In this research, legal research can be divided into Normative and Empirical research. Normative Law Research is a study of library materials (Secondary data) with issues to be analyzed, both in the form of primary legal materials and secondary materials[10]. This research was conducted in the vicinity of communities close to modern markets and not far from traditional markets (Gelugur Market, Lama Market, Sigambal Market, and Aeknabara Market) in Labuhanbatu District in four months in December 2018 - March 2019. research purposes. This study analyzes secondary data using 1 (one) method, namely document study. Sampling is done by non-probability sampling with a purposive sampling technique. Samples are traders who seek their business 500 meters from the modern market or directly accept payments from the modern market, receiving 45 respondents.

IV. RESULTS AND DISCUSSION

A. Results

The number of respondents in this study was 45 respondents. Based on the questionnaire that has been distributed, it can be seen the respondent's identity as follows:

1) Characteristics of Respondents by Origin

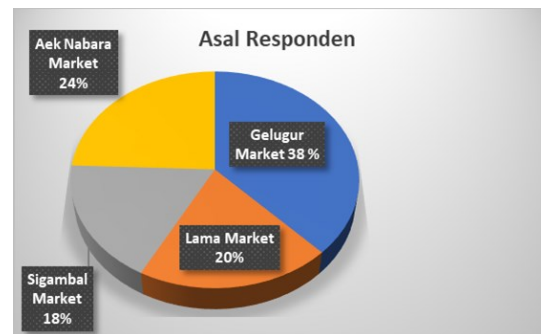

Fig.1 Original Graph

From Figure 1 it is known that the respondents' identities based on origin in this study mostly came from the Gelugur Market Rantauprapat at 38%. Respondents based on the origin of the Lama market amounted to 20.0%. Respondents were based on the Sigambal market origin at 18% and respondents based on the origin of the Aek Nabara market at 24%. It can be explained that Gelugur Market was previously a relocation from the Lama Market which later experienced revitalization, through the revitalization program the name changed to Gelugur Market. The presence of Gelugur Market provides convenience to traders and managers because in the revitalization there are already parking facilities so that those who spend using cars or motorbikes can park and invite investors.

2) *Characteristics of Respondents by Frequency*

The characteristics of the respondents based on the frequency of visits from all respondents were more dominant stating to the traditional market as much as 73 %. Most respondents go to traditional markets to buy merchandise for basic needs and others, this is done because according to respondents the price of merchandise is a process of bargaining before a transaction occurs. While 27 % of respondents went to the modern market to buy merchandise that was not available in traditional markets or complementary goods. This study confirms that between traditional markets and modern markets having the same customers only in certain conditions all depends on the needs of the community

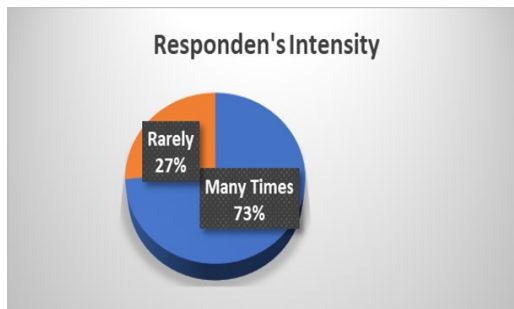

Fig.2 Graph of Intensity

3) *Characteristics of Respondents Based on Respondents' Business Distance with Modern Markets*

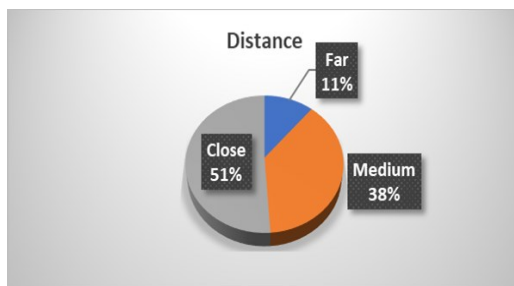

Fig.2 Graph of Business Distance

From figure 3 it is known that the distance of business/traditional markets with modern markets as much as 51.0% states close. Most dominant modern markets encountered in the field include Indomaret, Alfamidi, and Alfamart and Brastagi Supermarket and Suzuya Mall Rantauprapat. The presence of a modern market in the midst of people's lives still leaves a polemic, especially close to the traditional market environment or small traders that existed before the modern market emerged, both the positive and negative impacts that are still a real threat to traders around them.

B. *Discussion*

Implementation of Government Regulations[6]-[8] was made as an effort to protect entrepreneurs, especially traditional traders. Although there has been a policy of the Labuhanbatu Regency government regarding regulations on structuring and fostering traditional markets, shopping centers and modern shops. The policy on structuring and fostering traditional markets, shopping centers and modern shops in general is usually in the form of laws, Central and Regional Government

Regulations are only a dream if not implemented properly[11]. She added that the regulation[6]-[8] contains articles that benefit and favor the people, especially traditional traders. The existence of a traditional market that is now fading along with the onslaught of modern markets, does not make the traditional market shaky in the face of competition, but its presence slowly begins to overwhelm many traditional markets in the face of increasingly fierce business competition. The results of study[12] prove that distance has a significant effect on profits, meaning that strategic market distance will provide benefits and increase for traditional traders rather than modern markets.

In this regulation[13] explained that traditional markets are markets that are built and managed by the government, regional government, private sector, state-owned enterprises, and regionally-owned enterprises, including cooperation with the private sector with businesses, shops, kiosks, booths and tents owned / managed by small, medium, community-based traders or cooperatives with small-scale businesses, small capital and with the process of buying and selling the merchandise through bargaining. This further shows that the government will not allow traditional markets in all corners to sink, whereas in the regulation it explains traditional markets maintained and protected by each government manager, local government, private sector or other business entity. Until now traditional markets are still the prima donna because they help the government through market retribution.

This research[14] found that five traditional markets were experiencing increased sales turnover after modern markets (Indomaret, Alfamart, and Alfamidi or the like) operating around traditional markets. He added that the increase in turnover was due to traditional market small traders applying business strategies such as pricing strategies and diversification of products sold, meaning traditional traders were specifying the goods they sold, making it difficult for customers/communities to find their needs

A minimum of one author is required for all conference articles. Author names should be listed starting from left to right and then moving down to the next line. This is the author sequence that will be used in future citations and by indexing services. Names should not be listed in columns nor group by affiliation. Please keep your affiliations as succinct as possible (for example, do not differentiate among departments of the same organization).

This Research[15] explains that traditional markets have strong characteristics, where the characteristics of traditional markets are strategic locations, where most traditional markets are located near residential areas, usually traded commodities are commodities of daily necessities, in traditional markets, there is still a culture of bargaining in the buying and selling process. This is a characteristic of traditional markets that cannot be found in modern markets because the bargaining process has existed since the market began, so it has become a culture for traditional markets and their physical condition that seems untreated such as a dirty, smelly and muddy rainy day.

Accordance Minister of Trade Regulation[13] the government must be more focused and concerned about the existence of traditional markets as one of the cheap public facilities that support the economic activities of the community to revitalize traditional markets is considered very strategic to improve traditional market competitiveness and generate and reinvigorating its existence, while positioning the traditional

market with a one-stop shopping concept that is safe, comfortable, clean and economical for both buyers and traders.

Of course, the existence of this traditional market is impossible to maintain if the government itself does not pay special attention to the sustainability of this traditional market, there must be cooperation between the government and traditional market players so that the existence of this traditional market can be maintained and not less competitive with the modern market. Such cooperation can be biased in the form of a law and regulation concerning civilizing traditional markets, or levies on the wider community to re-enliven traditional market, more than that with the presence of foreign investors who carry large-scale capital to the homeland, this will be a threat to small-scale entrepreneurs and traditional markets, therefore the government must also ensure how these traditional market players can continue to run, one of which is by providing capital loans, but more importantly the training of entrepreneurial skills to be able to compete with foreign parties who come so that the Traditional market players are not gone eroded by the age amid the rise of modern markets that are increasingly developing everywhere.

C. Findings

From the analysis and discussion conducted, it was found that the implementation of government regulations concerning the establishment of modern markets should have been regulated by this regulation[6]-[8] was made as an effort to protect entrepreneurs, especially traditional traders, but in some regions, it has not been effective. This is because the synchronization of central and regional policies has not been implemented properly, looking at regional demographics. This is supported by a large number of studies taking the topic of the existence or existence of traditional markets in various regions illustrating that the role of traditional markets is so great for regional growth especially the welfare of traders compared to modern markets that highlight profits to their owners. According to this[16], providing containers and structuring for informal traders is an effort to provide binding controls and regulations to increase trade in the informal sector.

In Indonesia, local supermarkets have been around since the 1970s, although they are still concentrated in big cities. Foreign-brand supermarkets entered Indonesia in the late 1990s since the policy of direct foreign investment in the retail business sector was opened in 1998. Increasing competition has prompted the emergence of supermarkets in small cities to find new customers and price wars. As a result, if Indonesian supermarkets only serve the upper middle-class people in the 1980s to the early 1990s (CPIS 1994), supermarket supermarkets to small cities and the existence of predatory practices through price-cutting strategies allow lower-middle-class consumers to access supermarkets[17].

The existence of a modern market adjacent to traditional markets influence the economy of traditional market traders and the surrounding community who open a business at home because it can reduce profits and physical sales of traditional markets. The rapid growth of the modern market in the residential area hurts traditional market traders that already exist in the region[7]. The characteristics of modern markets in addition to large buildings and strategically located with the community or small traders are also other advantages of convenience and service in shopping, and have a wide network

of partners with product distributors so that large-scale and long-term distribution of merchandise.

According to this[9], the impact of the existence of modern markets on the number of types of goods traded in traditional markets. As for the number of buyers, the number of suppliers, and the number of workers, which has declined after the modern market, which means that the number of buyers, the number of suppliers and the number of workers in traditional markets is smaller. In addition to the decline in turnover, the results of field observations also show that most of the people shop in modern markets such as Alfamidi and Indomaret as routine, monthly shopping, and several times shopping.

This activity indicates that some of the people are affected and prefer to shop in modern markets, even though the items purchased are not fully nine main staples, sometimes what is sought in modern markets is complementary or complementary goods. The rules regarding the establishment of a modern market must include the socio-economic impacts of traditional markets and small businesses that have already been around it are not taken seriously. Indications towards the game between groups of modern market entrepreneurs and the government increasingly reveal the surface. All these factors separate the sadness of the existence of traditional markets and traders in them. The presence of a modern market with enormous market power, based on capital, is able to erode every opponent including traditional markets. We can see from Carrefour's current position. Various business strategies he developed to sustain brand image as a retailer of goods at the lowest prices in Indonesia, has always been a trend in its management in Indonesia. In various respects, it must be recognized that Carrefour has developed into a trendsetter for Indonesia's retail business[18].

It is clear from the findings of this study, that consumers in the modern market provide retail service quality is better than the traditional market. Thus, the traditional market will experience growth pressure, if not changed its perception through improved quality of service. Accordingly, the government should make the policy of petrified growth. However, changes in market perceptions of the traditional image of the seedy, chaotic, muddy, dirty and lack of facilities such as limited parking space, bins are smelly and dirty, the hallways are narrow and so on need to be eliminated[19].

V. CONCLUSION

The presence of a modern market in a business environment that is increasingly difficult raises the pros and cons. In the beginning, the presence of the modern market was opposed by the people who considered it would have a negative impact especially on traditional traders in Labuhanbatu Regency. From the results of this study that between traditional markets and modern markets have the same customers only in certain conditions all depends on the needs of the community. The closer the business location between the community or the trader and the modern market makes the level of business competition more unavoidable. This also shows the growth of the modern market that is close to the market location in the Labuhanbatu Regency is a threat to the traders who are around it. Apart from that, the government's efforts to maintain the existence of traditional markets are also seen with the existence of regulations issued by the government, the government's enthusiasm to provide protection for the

existence of traditional markets has been proven by the released of Presidential Regulation[6] concerning Arrangements And Guidance of Traditional Markets, Shopping Centers and Modern Stores and their technical descriptions have been regulated in the Regulation of the Minister of Trade of the Republic of Indonesia[13] concerning Guidelines for Structuring and Guiding Traditional Markets, Shopping Centers and Shops Modern. The two regulations constitute the development of the spirit of Indonesia Law No. 5 of 1999 concerning the Prohibition of Monopolistic Practices and Unfair Business Competition.

REFERENCES

- [1] Sindonews, "Position of traditional markets in people's lives," *sindonews.com*, 2018.
- [2] J. Kacetla, "Business Ethics for Students of Management," *Procedia - Soc. Behav. Sci.*, vol. 109, pp. 875–879, Jan. 2014.
- [3] R. T and T. CP, *The Supermarket Revolution with Asian Characteristics*. Singapore: Institute of Southeast Asian Studies and Southeast Asian Regional Center for Graduate Study and Research in Agriculture, 2007.
- [4] W. Setiawan and P. S. Barrett, "The Built Environment Element of Economic Development in Post Conflict Response in Indonesia," *Procedia - Soc. Behav. Sci.*, vol. 234, pp. 478–487, 2016.
- [5] S. Sarkum and R. Watianthos, "Market price stabilizing strategy: overview of the combination of SWOT and QSPM analysis," *J. Manaj. Motiv.*, vol. 14, no. 2, p. 53, 2019.
- [6] Perpres 112, *Penataan Dan Pembinaan Pasar Tradisional, Pusat Perbelanjaan Dan Toko Modern*. 2007.
- [7] Fajriawati, "Analisis Pengaruh Persaingan Usaha Pasar Tradisional Terhadap Pasar Modern Peraturan Daerah Kota Medan," *J. Ekon.*, vol. 13, no. 2, pp. 2579–5198, 2017.
- [8] Permendagri, *Pedoman Penataan Dan Pembinaan Pasar Tradisional, Pusat Perbelanjaan Dan Toko Modern*. 2008.
- [9] B. Haryanto, "Dampak Ekspansi Hypermarket Terhadap Pasar Tradisional di Daerah," *Bina Praja*, vol. 6, no. 3, pp. 234–248, 2014.
- [10] S. Soekanto, *Pengantar Penelitian Hukum*. Jakarta: UI Press, 2010.
- [11] Eka and Yuliasih, "Studi Eksplorasi Dampak Keberadaan Pasar Modern Terhadap Usaha Ritel Waserda Dan Pedagang Pasar Tradisional Di Kecamatan Klirong Kabupaten Kebumen," Universitas Negeri Yogyakarta, 2013.
- [12] W. Sasana, "Analisis Dampak Keberadaan Pasar Modern Terhadap Keuntungan Usaha Pedagang Tradisional (Studi Kasus di Pasar Tradisional Kecamatan Banyu Manik Kota Semarang)," *Diponegoro J. Econ.*, vol. 2, no. 1, pp. 1–6, 2013.
- [13] Permendag 53, *Pedoman Penataan Dan Pembinaan Pasar Tradisional, Pusat Perbelanjaan Dan Toko Modern*. 2008.
- [14] E. Sarwoko, "Dampak Keberadaan Pasar Modern Terhadap Kinerja Pedagang Pasar Tradisional Di Wilayah Kabupaten Malang," *J. Ekon. Mod.*, vol. 4, no. 2, 2008.
- [15] Sasanto Reza and M. Yusuf, "Identifikasi Karakteristik Pasar Tradisional Di Wilayah Jakarta Selatan (Studi Kasus : Pasar Cipulir, Pasar Kebayoran Lama, Pasar Bata Putih, Dan Pasar Santa)," *PLANESA*, vol. 1, no. 1, 2010.
- [16] Agustin, "Teritori Pedagang Informal (Studi Kasus Ruang Antara Pasar Johar dan Pasar Yaik Semarang)," *Arsit. Nalars*, vol. 13, no. 1, pp. 1–10, 2014.
- [17] Daniel Suryadarma, A. Poesoro, S. Budiayati, Akhmadi, and M. Rosfadhila, "Dampak Supermarket terhadap Pasar dan Pedagang Ritel Tradisional di Daerah Perkotaan di Indonesia.," 2007.
- [18] Rusham, "Analisis Dampak Pertumbuhan Pasar Modern Terhadap Eksistensi Pasar Tradisional Di Kabupaten Bekasi," *J. Ilm. Ekon. Manaj. Dan Kewirausahaan "Optimal"*, vol. 10, no. 2, 2016.
- [19] A. Sosianika and M. F. Najib, "Retail Service Quality In Indonesia: Traditional Market vs Modern Market," *Acad. Mark. Stud. J.*, vol. 21, no. 2, pp. 1–12, 2017.

Youtube, from Mass-Self Communication to Commodification of Audience and Worker

Puthut Ami Luhur
Magister Ilmu Komunikasi
Universitas Diponegoro
Semarang, Indonesia
puthut.ami.luhur@gmail.com

Abstract— Communication is sharing meaning through the exchange of information where the process is determined by the communication technology used, the characteristics of the sender and recipient, the culture that is behind and how the communication is carried out. In this process, the type of communication must be distinguished. But with the development of the internet, a new form of interactive communication emerged, Castell called this a new form of mass communication, or what he called mass-self communication. This is mass communication because it has the potential to reach a global audience, at the same time, it is intrapersonal communication because the production of messages is self-made, the definition of the recipient is self-directed. On its journey mass-self communication is useful for public openness as done by several regional heads in Indonesia, Ridwan Kamil and Ganjar Pranowo. The mass-self communication strategy carried out by these two regional heads basically has almost the same thing. Content placement is based on the suitability of the platform so that it successfully encourages community participation. Community participation can ultimately succeed in government programs because of the accuracy in the use of effective and efficient social media. The YouTube platform developed into a kind of industry, with users who can make YouTube as a land for opportunities to earn income or even as a profession. Now those who rely on income from YouTube are known as Youtubers. Youtubers, both individuals, groups, communities, and large companies, produce their own unique videos, specifically to be displayed on YouTube. The material obtained by a Youtuber is actually not easy to obtain. Requirements, the channel must have reached 1000 subscribers and 4000 hours of viewing time in the last 12 months. They not only produce but also distribute to a wider audience. Commodification of audiences and workers occurs where producers and consumers of their lines run away and are then called prosumer.

I. INTRODUCTION

Communication is sharing meaning through the exchange of information where the process is determined by the communication technology used, the characteristics of the sender and recipient, the culture that is behind and how the communication is carried out. The meaning of communication can only be understood as the social relations context in which information and communication are processed. In this process, it must be distinguished between interpersonal communication and mass communication. On interpersonal communication, both the sender and recipient of the message are the subject of communication and are interactive because of the feedback while the mass communication information can be disseminated simultaneously where it can be interactive or also one-way. In general mass communication is one-way because the recipient of the message is not

immediately able to do feedback when receiving the information delivered. The audience can only do feedback using other communication tools.

But with the development of the internet, a new form of interactive communication emerged, marked by the capacity to send messages from many to many, in real time or selected time and with the possibility of using point-to-point communication, narrowcasting or broadcasting, depending on the objectives and characteristics of the practice intended communication. Between interpersonal communication and mass communication is almost no difference. They go hand in hand, interact and complement each other do not replace each other. Many platforms have emerged, including blogs, youtube and so on, which were originally intended as a forum for expression of users, or as a place to conduct interpersonal communication.

Uploading on a blog or youtube, was originally intended for the needs of each uploader, as a form of self-expression. Deliberately or not, users spread it through links that are shared through social media or other channels so that it becomes mass communication. The internet is not only used as mentioned above, it is also a means of interactive communication so that the boundaries between mass media communication and other forms of communication are unclear. Apart from being a means of sending messages of any kind, whether in the form of text, video and audio or anything that can be digitized. The internet, in its various applications, is the communication thread of our lives, for work, for personal connections, for social networking, for information, for entertainment, for public services, for politics, and for matters relating to religion. In addition, the internet is increasingly being used to access mass media (television, radio, newspapers), as well as all forms of cultural products or digital information (films, music, magazines, books, journal articles, databases).

This study intends to understand the development of platforms that were originally created as a forum for self-expression into mass communication media, then commodified because content created by users can be monetized. This research is useful as an academic study to understand the platforms that are present with the existence of information technology as a development of the emergence of the internet. Whereas practically, this research is expected to provide benefits and uses for sharing site users to pay more attention to the content of the material shared. Socially, this research is useful for the community that sharing sites are not just a container of expression but also have other purposes.

II. LITERATURE REVIEW

Castell calls this a new form of mass communication. This is mass communication because it has the potential to reach a global audience, such as posting videos on YouTube, blogs with RSS links to a number of web sources or messages on the mailing list. At the same time, it is intrapersonal communication because the production of the message is self-made, the definition of the recipient is self-directed, and the retrieval of messages or certain content from the World Wide Web (WWW) and hand-picked electronic communication networks. Three forms of communication (interpersonal, mass communication, and mass-self communication) go hand in hand, interact, and complement each other rather than replace one another (Castell, 2009: 55).

Mass communication in the traditional sense is now internet-based communication both in production and delivery. In addition, the combination of online news with interactive blogging and e-mail, as well as RSS feeds from other documents on the web, has turned newspapers into components of different forms of communication: what is called mass-self communication. The Castells theory that mass-self communication is based on Umberto Eco's semiotic communication model as the emergence of a "creative audience" (Castells 2009, 127-135) involved in "interactive production of meaning" (132) and based on the emergence of the "sender / sender" figure (130) (Fuchs, 2014: 75).

Castells argues that the contemporary internet is shaped by conflicts between global multimedia business networks that try to commodify the internet and "creative audiences" who try to establish the level of citizen control over the Internet and assert the right to communicative freedom without corporate control (Castells 2009, 80, 97, 136).

Free labor produces more value that is adjusted and changes to corporate profits. Despite Toffler's uncritical optimism, his ideas about "prosumer" illustrate important changes in the structure of the media and practices that can be adopted through critical studies (Fuchs, 2012: 143)

YouTube as well as other social media that generate profits for investors in this case the owner of the platform. But the concept of exploitation is not explained in the ideas above. Fuchs explain the concept exploitation according Marx in Facebook. To understand how exploitation through YouTube works, it is necessary to get into some details of the Marxist political economy. For Marx, the average profit is the relationship of profit and investment.

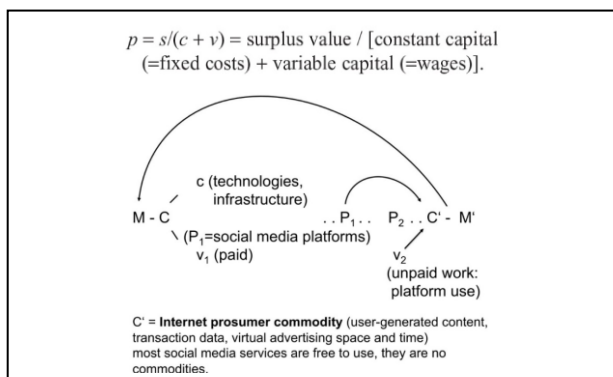

Facebook invests money to buy capital, technology and labor. Their products include user-generated data, personal

data, and transaction data about browsing and communication behavior on Facebook. Users invest certain work time in this process. Facebook sells commodity user data to advertising clients at prices greater than constant capital and invested variables. The surplus value contained in this commodity is partly made by users, in part by Facebook employees. The difference is that users are not paid, and therefore are exploited indefinitely. After the prosumer internet commodity (which contains user-generated content, transaction data, and the right to access virtual space and time) is sold to advertising clients, the commodity is converted into monetary capital and the surplus value is realized into money (Fuchs, 2012: 143). The logic Fuchs describes regarding commodification is almost the same as what happened to YouTube, and it continues to happen repeatedly. If internet users become productive consumers of Web 2.0, in Marxist terms as class theory, this means that they become productive workers who are exploited by capital because for Marx productive labor produces more value (Fuchs, 2012: 144).

III. METHOD

This study use qualitative methodology by interviewing two source who use Youtube media as mass self communication but monetize their accounts, the two source have produced and uploaded videos made more than one year. The first source has benefited from the monetization of his Youtube account while the second source has not enjoyed monetization from Youtube.

IV. NOVELTY

This research give alternative, see not only the benefit from social media like Youtube but also behind that is any exploitation.

V. RESULT AND ANALYSIS

The YouTube environment strongly supports the growth of creators and audiences contributing to increasing people's interest in using YouTube. YouTube creators, known as YouTubers, compete with each other to produce videos with content as attractive as possible and unique than others. At first these YouTubers may not think of rewards, the important thing is that the video is watched and liked and the channel (channel) is followed (subscribed) to the people who consume it. Intensive giving of the distribution of advertisement cakes obtained from YouTube as a form of compensation for videos produced by YouTuber because of the insertion of advertisements as a result of the large number of viewers, making YouTubers more aroused continues to make videos that attract the attention of the audience.

Users on Youtube, not only use and consume content contained in Google's social media but also produce and distribute it. Whereas on the YouTube platform, like other social media platforms. YouTuber before monetizing his channel (channel), must first agree to the requirements requested by the service provider. After YouTuber produces content then uploads it to the network owned by the service provider, he will wait for the content he produces to be able to meet the requirements of getting monetization. They will not stay silent if the content they produce wants to get monetization from YouTube immediately.

The initial development of YouTube, the creator of this video service provider, provided stimuli to the audience by uploading various creative videos and promoting them to various existing channels. After YouTube was acquired by Google, the channel to promote this online video platform increased. Then the audience who initially only saw the videos that were displayed was interested and felt called to make a video which was then shared on this platform. At this stage the creative audience appears. More and more videos are shared by users who already have accounts on the YouTube platform that are connected to other platforms created by Google.

Video creator accounts on the YouTube platform are popping up and more videos are published by each user. YouTube visitors who only want to see videos that have been uploaded by other users are also growing. Some videos can be seen by thousands to millions and even billions of audiences from all over the world but there are also those that are only watched by dozens of people. The potential audience of YouTube videos is large, seen by the owner as a market niche that can be used to find income and even profits by offering advertisers.

Ads on YouTube begin to appear in every video that has been uploaded through a YouTube account owned by the user. To further enlarge the market by attracting more and more audiences, more and more interesting content is needed. YouTube then divides the advertising revenue to video creators whose videos get advertisements because they are watched by many other users around the world. Over time, so advertisers are satisfied with the advertisements that are installed because the possibility of being able to be watched by a wider audience, YouTube also gives creators certain conditions to be able to get advertisements arranged by the owner of the application. The tighter conditions made by YouTube are increasingly creative and interesting as well as the videos uploaded.

Various creators have also made various ways to make the videos they produce creative and interesting for other YouTube users to want to watch, starting from sharing links to their social media accounts to sharing by providing snippets in the story on both Whatsapp and Instagram accounts that enable it do. The hope is to spread the link of his video that has been uploaded to YouTube, in addition to introducing his channel also attracting viewers. In this way, hopefully there are friends or followers in the creator's social media account interested in seeing the video. If you have watched one video and feel interested, the audience is likely to see another video that has been created and uploaded by the user who is also the creator. There are also those who make the title of the video interesting or inviting curiosity, so the audience voluntarily opened the upload video. To promote and attract audiences, there are also YouTube creators who intentionally enter the comments page of the successful team Facebook head of a regional head or president for political videos while product videos, YouTuber may enter the product account comments when discussing the same product.

Mostly YouTuber starts with a simple tool, in the digital era like today where it is easy to find a mobile phone that has been integrated with a camera that can take still images (photos) or move (video) easily and of course adequate

resolution for later uploading to YouTube account. Likewise with editing, it can be done quickly with applications offered in Playstore or on iStore, ranging from well-known branded cell phones or not, based on Android or iOS. But before the smartphone era was used, YouTube content creators had to have a video camera by editing through a computer or laptop.

But in its development, creators on YouTube began to consider better and interesting image quality, besides YouTube also provides video options that can be watched with low to high resolution. They then renew the device, not only using smartphones but also professional cameras. There are also creators who later did not work alone like when they first produced the video to upload to YouTube.

A. Mass Self Communication in Youtube

The two interviewees admitted, initially uploading Youtube videos just wanted to convey their ideas through video. Even the second speaker who works as a journalist claimed, uploading videos via Youtube was only to give the other side of the coverage he had done. Videos that he thinks will not be broadcast by the media company where he works will be uploaded to his Youtube account. Not only one side is uploaded, but there are a number of angles that he thinks are impossible to display in the place of a media company, where he works.

While the first resource person, tends to want many people to listen to their ideas or syndicates about the surrounding environment through videos uploaded through his personal Youtube account. But after feeling a lot of people watching his creation videos on his Youtube account, he felt the need to monetize his account, so that he could continuously and continuously send his creation videos. Especially after knowing the various ways that can multiply his income through Youtube, he also carried out various ways that have been learned, including what he called "nyepam" which is entering into the comments column of the status of people associated with his video on Facebook and other social media.

While the second guest speaker, who initially admitted uploading his creation video to his Youtube account, was only to find a place of expression and share videos with other angles which would be interesting and much watched but not enjoyed by media entrepreneurs. However, he also hopes to be able to earn income from Youtube through the YouTube Partnership Program by monetizing his own account even though until now there are no advertisements that have been included in the videos he had uploaded. According to him, he must wait longer than the others.

B. Youtube Worker (Youtuber)

In accordance with Undang undang Nomor 13 Tahun 2003 concerning Manpower, what is called labor in Article 1 paragraph (2) is every person who is capable of doing work to produce goods and / or services both to meet their own needs and for the community. Then in paragraph (3), it is increasingly explained that workers / laborers are everyone who works by receiving wages or other forms of compensation. So if in accordance with the law, a YouTuber can be referred to as a worker or labor because it produces goods and / or services, both meeting their own needs and the community. A YouTuber also receives wages or other forms

of rewards after the regulations required by the media to share the video.

The YouTube platform can also be referred to as the employer in accordance with Law Number 13 of 2003 concerning Manpower, Article 1 paragraph (4) where mentioned, the employer is an individual, entrepreneur, legal entity, or other agency that employs workers by paying wages or other forms of compensation. Between YouTube and YouTuber there is a working relationship in accordance with Article 1 paragraph (15), is the relationship between employers and workers / laborers based on work agreements, which have elements of employment, wages, and orders.

The employer is obliged to register himself and his workers as participants to the BPJS, in accordance with the social security program that is followed and workers have the right to register themselves as participants in social security programs at the expense of the employer if the employer has obviously not registered their workers with the BPJS. Employers who employ as many as 10 or more workers, or pay wages of at least Rp. 1 million a month, must include their workforce in the labor insurance social program.

The sanctions if companies other than state administrators do not carry out the obligation to register their workers as Participants to BPJS are administrative sanctions. Administrative sanctions can be in the form of written warnings, fines; and / or and not getting certain public services. All of this is regulated in Law Number 24 of 2011 concerning the Social Security Organizing Agency, in addition to the Labor Law.

YouTube has a program called the YouTube Partnership Program. The YouTube Partnership Program is designed specifically for individuals who want to become YouTube's permanent creators. To be able to join the YouTube Partnership Program, creators must first have a Google account to create channels and AdSense accounts to receive payments. After that, creators must have the number of videos, the number of views, and the number of viewers with a consistent increase. Creator activities must comply with service requirements, community guidelines and copyright guidelines so that they can consistently become advertiser-friendly channels. YouTube always educates creators about various things related to their creative activities on YouTube. Various types of support services and facilities are arranged based on the number of subscribers owned by creators. Creators who have become part of the YouTube Partnership Program can monetize the videos they make. This monetization process allows creators to benefit in the form of money from displaying ads on videos and / or video pages. Creators can also come out freely from this collaboration if they no longer want it.

From the results of interviews with two existing source, one of them claimed to be earning income from the revenue sharing of advertisements posted by YouTube on videos produced by informants. While other source said they did not get it. Both claimed, to earn income from YouTube must follow the requirements of the service provider. The two interviewees interviewed were not very clear, whether he worked for YouTube or not. Even so, a Youtuber can be considered to work for Youtube where he receives rewards in the form of money or other forms.

From the interview, the Youtuber who has been able to generate income, only gets the result of a predetermined Youtube share of the ad revenue installed on the video he made. Youtuber also only gets revenue from advertising revenue, but does not get social security as well as rights obtained by other workers. They also do not demand because they think that what they have done is not solely for earning income as if working in a company but because they want to convey information through new channels, namely social media.

C. YouTuber not Only Content Creator

YouTuber before monetizing his channel (channel), must first agree to the requirements requested by the service provider. After YouTuber produces content then uploads it to the network owned by the service provider, he will wait for the content he produces to be able to meet the requirements of getting monetization.

YouTubers not just sit and wait if the content they produce wants to get monetization from YouTube immediately. The first source stated that to attract viewers and subscribers he did a promotion by dividing the link and / or video footage through the instastory and whatsapp story and creating an Instagram account with the same identity as the channel's identity on YouTube to be better known. Besides, dividing the links into whatsapp groups that he follows. He hopes, through this way many people click and watch the video. There are some that reach dozens of viewers and some even reach tens of thousands.

In addition to spreading links, he also packs video titles with interest so as to lure other users on YouTube to watch the video. According to him, the title of the video he produced with the contents of the video was not much different even though he knew the term clickbait title. The video content produced by the first guest speaker is the other side of the results of his daily journalist coverage. There are contents that are entertaining and some are informative.

While the second source, he did another strategy. In addition to packing an interesting title, he spread the link of his creation video to several groups on Facebook. Because he produces political content that is partially filled with comments from speakers about politics, the video link he produces is shared through Facebook groups affiliated with political figures. For example to the Prabowo group and the Jokowi group. He termed, activities spread links to these groups as "nyepam."

In addition to also making a description of the video that has been produced, in the description the resource person also included ccs in several other countries outside Indonesia. For example Hong Kong cc or Australian cc. In this way, besides increasing the number of viewers because it can be enjoyed not only in Indonesia but also abroad. He can also add to the coffers of income from the results of monetization because there are differences in the nominal financial amount obtained between YouTubers in Indonesia and overseas YouTubers.

They also consume content offered by the social media platform. Both of them cannot mention the duration of time when consuming these content. It can be seen, the producer of video information which is then uploaded via Youtube as well as consumers of video content made by other creators. This is

what is called Prosumer. Between producers and consumers there is almost no distance and boundary in the current era.

VI. CONCLUSIONS AND RECOMMENDATIONS

YouTube media is like social media in general, initially to spur audiences to produce creative content. The content is seen by the media owner as having the opportunity to generate profits with the data owned. Media owners then bring it to advertisers who then place advertisements on YouTube content produced by the audience or which is now referred to as prosumer. Prosumer is initially not paid by the YouTube owner but then gets a portion of the ad revenue with certain conditions. Creator content continues to reproduce content so that it continues to generate income for it from incoming advertisements. Commodification of content occurs here. Even though they get money from YouTube owners, in Marx's view it is not salary or payment.

Even though it can be seen critically, social media can be used by regional heads or government institutions to dismantle bureaucracy and promote democracy, while at the same time inviting community participation in development. Although the head of the region has the importance of this as an image of himself to the community he is leading.

REFERENCES

- [31] Allan, Stuart. 2007. Citizen Journalism and the Rise of "Mass Self-Communication": Reporting the London Bombings. *Global Media Journal*, Australian Edition. Issue 1, Volume 1:2007.
- [32] Arisanty, Melisa & Meiselina Irmayanti. 2016. Strategi Mass Self Communication Kepala Daerah di Media Sosial dalam Mewujudkan Partisipasi Masyarakat Untuk Menyukseskan Program Pemerintah Daerah. *Prosiding Komunikasi, Akselerasi Pembangunan Masyarakat Lokal Melalui Komunikasi dan Teknologi Informasi*, Buku 2, Halaman 225-238.
- [33] Castells, Manuel. (2009). *Communication Power*. New York: Oxford University Press Inc.
- [34] Fuchs, Christian. (2014). *Social Media A Critical Introduction*. London:Sage.
- [35] Fuchs, Christian. (2012). The Political Economy of Privacy on Facebook dalam *Television & New Media Jurnal* Vol. 13(2), 139-159. Sage.
- [36] Meola, AndrCoew. 2016. Mobile Search and YouTube Continue to Drive Google Ad Revenue, <http://www.businessinsider.com/mobilesearch-and-youtube-continue-to-drivegoogle-ad-revenue-20164?IR=T&r=US&IR=T>
- [37] Ini Pendapatan Andalan Google, Wah Jumlahnya Fantastis, <http://manado.tribunnews.com/2017/10/27/ini-pendapatan-andalan-google-wah-jumlahnya-fantastis>.
- [38] "Dari Mana Asal Duit Para Youtuber?", <https://ekonomi.kompas.com/read/2015/09/17/060700726/Dari.Mana.Asal.Duit.Para.Youtuber>.
- [39] 4 Sumber Pendapatan YouTuber Selain dari AdSense", <https://tekno.kompas.com/read/2017/12/28/19280027/4-sumber-pendapatan-youtuber-selain-dari-adsense>
- [40] Startup Masih Salah Bedakan User dan Customer, <http://marketeters.com/startup-masih-salah-bedakan-user-dan-cus>

Service Management of Customer Complaints in the Tourism Industry in Yogyakarta (Case Study on Sindu Kusuma Edupark Tourism Yogyakarta)

Kristina Andryani

Communication Science Program, Mercu Buana University of Yogyakarta,

kandryani@mercubuana-yogya.ac.id

Abstract- The world of tourism is currently growing rapidly, this is believed by the many regions that have begun to develop their tourism potential in order to present interesting treats for migrants who want to release fatigue in the midst of busy work, especially for millennials now. the need for lifestyle and the need for social media, making travelers hunt interesting and unique photo spots. One of the attractions used in providing services to travelers is Sindu Kusuma Edupark Yogyakarta by formulating a problem how management handles customer complaints in order to continue to provide the best service so that this tourism vehicle still exists in the tourism industry and can compete with vehicles that similar in the Yogyakarta region. The research method used in this case is observation and in-depth interviews with the tour manager to deepen the data collection process and can produce the right analysis. The results of this study are expected to be able to implement a systematic procedure and plan for handling customer complaints, so that anyone who becomes a manager can still refer to established and tested procedures.

Keywords: management, services, customer complaints, tourist rides.

Introduction

In recent years, the tourism industry has progressed rapidly, this is evidenced by the many tourists who visit tourism places every year and the need for entertainment and experience that is utilized by each individual, making tourist attractions full every year. Based on data from the Central Bureau of Statistics, the number of foreign tourist visits to Indonesia in June 2018 reached 1.32 million. Thus an increase of 15.21 percent per year per year. It was said by the head of BPS, Suhariyanto that the number had increased from the same period last year, thus appeal to the government to seek more ways to enlarge the number of foreign tourist arrivals to Indonesia because this can affect all levels of society by moving their economy and in accordance with their vision and mission of the Indonesian nation so that every sector can grow the creative economy as a source new economic growth.

Similar to the growth of tourists to Indonesia, statistical data in 2018 for the Yogyakarta region in the tourism sector also increased. This was reported by the *Tribun Jogja* newspaper released by the Yogyakarta City Tourism Office that: the number of tourists who travel to the city of Yogyakarta, both foreign tourists and domestic tourists, almost reached two million tourists, to be exact at 1,859,888

people. In addition to holding various events to boost the number of tourists, the regional government will also increase promotion in the field of tourist objects in the city of Yogyakarta.

Of the many tourist attractions in the Special Region of Yogyakarta, the author takes one focus of a tourist attraction namely Sindu Kusuma Edupark because, this tourist vehicle is a vehicle that is a branch of Kusuma Agro Tourism located in Batu Malang, which has been established since 1989 which then expanded its wings to the Yogyakarta area which is also the most preferred by tourists as a tourist destination, but this tourist vehicle also has its own peculiarity in naming each vehicle of the game, this is adjusted to the place and region of tourism that stands. The naming of the playground in Sindu Kusuma Edupark tourism, is able to attract visitors because everyone feels curious about the naming that smells of the term Java which has been adapted to the culture of the city of Yogyakarta which is also called the city of Culture

The SKE family recreation vehicle (Sindu Kusuma Edupark) is located on Jl. Jambon, Sinduadi, Mlati, Sleman DIY. The SKE was inaugurated on December 20, 2014, which is a family recreation vehicle that is a vehicle for children and adults. The notaben is indeed this vehicle that provides entertainment and is intended for all. Sindu Kusuma Edupark is a business unit of Kusuma Agrowisata, which is located in East Java. Management of Sindu Kusuma Edupark is handled by management who already have experience in developing tourist attractions, by managing several Waterpark, Therepark and Edupark vehicles in Indonesia. Sindu Kusuma Edupark, which stands on a 7-hectare land, has a variety of attractions that can be enjoyed by tourists, among others, namely: Manggilingan Chakra, Egrang Pit, Montor Tumbur, Panggon Lunjak, Mabur Chair, Kluthuk Sepur, Mabur Bicycles, Puteri Commuter, Roti Puter, Little Sepur, Cleret Gandul, Ancient Car and several other game rides. From the above background, the problem formulation obtained in this case is: need service assistance to customers in the tourism industry at Sindu Kusuma Edupark Yogyakarta Tourism Forum?

The objectives in this study are:

1. To find out how management responds to complaints to customers
2. To find out the stages in managing customer complaints

Research methodology

This study uses a qualitative descriptive approach by looking specifically at the case of Customer Complaints Handling at Sindhu Kusuma Edupark Tourism Forum Yogyakarta in 2018. The qualitative research methodology is growing. Even in applied research, this methodology has become increasingly popular and requested by various sponsors because the results are in the form of encryption in the form of detailed and in-depth narratives, easier to understand and directly the benefits can lead to clearer and more detailed operational advice as an improvement effort and also in determining the choice of form of policy action.

Research Subjects and Locations

This research was conducted in Yogyakarta, specifically at the Sindhu Kusuma Edupark Tourism Forum as a place to explore data and conduct an in-depth interview process. The location is on Jalan Kragilan, Sinduadi, Mlati District, Sleman Regency, Special Region of Yogyakarta.

1. Data Collection Techniques

Various data collection strategies in qualitative research in general can be grouped in two types of ways, namely: methods or techniques of data collection that are interactive and non-interactive. In this study the method used is an interactive method or technique which includes:

a. Deep interview

In this research which is the resource person or informant is Public Relations from Sindu Kusuma Edupark assisted by HRD, the data that you want to get is about services and complaints or even issues that arise in tourists who visit with the aim of improving the quality of tourism vehicles being sheltered.

b. Observation plays an active role

This active role observation is a special way and researchers are not passive just as observers, but play various roles that are possible in a situation related to their research by considering positions that can provide access that can be obtained to be used for complete and in-depth data collection.

c. Review documents or archives

The documents in this regard revolve around the background of the establishment of Sindu Kusuma Edupark which originated from Kusuma Agro Tourism which was established in Batu Malang city as well as images related to facilities and rides managed by Sindu Kusuma Edupark Tourism.

2. Data Analysis Techniques

In the process of qualitative analysis, there are three main components that must be truly understood by each qualitative researcher. The three main components of the analysis:

a. Data reduction

Data reduction is the first component in the analysis which is the selection, focusing, simplification and abstract of all types of complete written information in the field notes. This reduction process continues continuously until the final report of the research is ready to be compiled.

b. Data presentation

As a component of the second analysis, data presentation is an assembly of organizational information, a description in the form of a complete narrative which in turn allows conclusions of research to be carried out. The presentation of this data is arranged based on the principles contained in the data reduction and presented by using the sentence and language of the researcher which is a composition of sentences arranged logically and systematically, so that if read will be easily understood

c. Withdrawal of conclusions and verification

Conclusions need to be verified so that they are sufficiently solid and truly accountable. Therefore it is necessary to verify which is a repetition activity for stabilization purposes, tracking data back quickly, perhaps as a result of second thoughts arising passing by the researcher at the time of writing the data presentation by looking back briefly at the field notes. Verification can even be done with more broadly by replicating in another unit of data ².

Theoretical basic

Previous research

The reference in making this research is from several different cases, one of them from a journal written by Kiki Handayani & Erman Anom (March 2010) with the title Role of Public Relations Implementing Crisis Management in Restoring the Image of PT. Garuda Indonesia After the Boeing G.737 / 400 Plane Accident in Yogyakarta, in the research it was said that one of the aircraft fleets from the first airline in Indonesia had an accident on March 7, 2007. The Garuda Indonesia aircraft was Boeing 737/400 Department of Jakarta - Yogyakarta with flight number GA-200 PK-GZC, which was flown by Capt. M. Marwoto Komar, caught fire at Yogyakarta's Adi Sucipto Airport carrying 133 passengers and 7 cabin crew. From the data, it was stated that 22 passengers were killed, 4 of them were foreign nationals, while the other passengers were injured and injured. Then from the accident, there was speculation about the issue of terrorism and human error. However, this was immediately disputed by the chairman of the Indonesian Pilot Federation, who said that the possibility of sabotage was very small due to strict and multi-layered security when entering the airport, from the main door until when it was going to the gate entrance. This accident made the image of Garuda Indonesia as an airline that prioritized service and safety for passengers,

2 H.B.Sutopo. 2006. Qualitative Research Methodology. Sebelas Maret University. P.113-116

tarnished. Many publics feel disappointed and are afraid to use airplane type air transportation lines after the incident.

The second reference material, there is a marketing journal written by George Knox and Rutger Van Oest in 2014, which says that customer complaints are part of the business aspect but there is no precise measurement of the impact of complaints and how to recover purchases for subsequent customers. Some steps are taken from the model proposed for the right decision making by a manager in restoring financially responsible services, especially in terms of costs and benefits

The third reference In the management of complaints raised by Alina Filip (2013), that the indicator of dissatisfaction must be addressed immediately so as not to eliminate potential customers and also an indicator that is easily tracked to avoid failures in the organization in the internal process. Organizations must know that the consequences of losing customers are a decrease in profits and negative word of mouth. With customer complaints, the greater the opportunity for organizations to improve managerial problem solving and eliminate the causes of customer dissatisfaction. So that an integrated system can be produced to improve business performance and avoid similar events in the future and customer loyalty is increasingly enhanced, and does not eliminate potential customers.

In exploring daily activities, surely we get a lot of messages or information from various channels, both when we listen to the radio or watch television or read newspapers and magazines, both media are conventional and online, messages or information we always get , but without realizing it, every information we listen to is not all we can remember or digest, only messages or information that really attracts attention that we can think about properly.

As stated by Lazarsfield as an observer of communication that: some messages might attract your attention, but fewer messages are able to give effect or impact and people like this are called "obstinate audiences". Public Relations practitioners are one of the parties who participate in competing for the attention of the public. The first task of a PR practitioner is: get attention from the target audience; second: attracting interest (interest) audiences to the content of the message; third: build a desire and intention of the audience to act in accordance with the message and fourth direct the actions of the audience to stay in accordance with the message delivered.³

Related to the duties of the public relations practitioner mentioned above, it is not uncommon for public relations practitioners to also face various problems that when it is not responded immediately can grow into a crisis. Rumors of information that we often refer to as issues are fundamental issues that require the handling of tersenderi for public relations. While the issue itself is an event that occurs outside the control of the company, which has an impact on the company's strategic goals, the core business and the existence

of the company that may require a certain response from the company. Can be simplified as a change and discrepancy between the environment and public expectations of the organization⁴ Issues that are not managed properly will cause crises and crises to potentially threaten the company's reputation. So every company or public relations practitioner should be able to control and manage issues. The issue management process will help to:

1. Identifying issues
2. Determine the impact of each issue
3. Prioritize issues and report on an issue
4. Review all problems and decide on an action
5. Take the steps needed to solve the problem quickly.

Meanwhile, The Public Affairs Council of America defines management issues as follows: "*The process by which organizations can identify and evaluate social issues and governance issues that are likely to affect the organization significantly, these issues can then be prioritized for the organization to respond well*"⁵

The focus of this research is how management issues can be managed properly through appropriate procedures. The management model of the issues raised by Register & Larkin is as follows⁶:

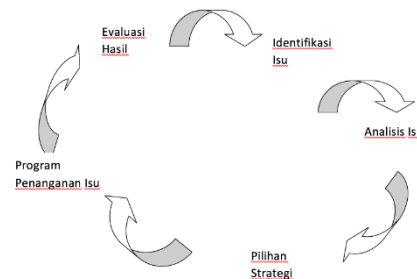

Identification of Issues; process to compare trends that occur within organizations with company performance. The main purpose of identifying issues is to place priority on various issues that are starting to emerge. 2. Issue Analysis; determine issues based on their urgency and impact. This allows companies to be able to distinguish between small issues and big issues. This type of issue can also be ranked based on the urgency and impact on the company. 3.Choice of Issue Change Strategies; is a stage that involves making basic decisions about the organization's response. 4.Issue Management Program; on program handling issues. This stage requires coordinating resources to provide this support. Organizations must decide on policies that support the desired changes to make the optimal PG so that the goals and targets can be achieved. 5. Evaluation of Results; a research is needed to evaluate how program implementation is carried out. The longer the issue develops, the fewer choices available and the more expensive the cost

Discussion

The aim of agro-tourism is to receive foreign exchange from the non-oil and gas sector, business

3 Morissan.2010. Public Relations Management. Jakarta: Kencana. P.41
 4 Firsan Nova.2011.Crisis PR. Jakarta: PT. Raja Grafindo Persada, P.239.
 5 Rachmat Kriyantono. 2012. Public Relations & Crisis Management. Jakarta: Kencana Prenada Media Group. P.163

6 Firsan Nova.2011.Crisis PR. Jakarta: PT. Raja Grafindo Persada, P.254-255

opportunities and employment through optimal utilization of agro-tourism potential as tourist visits. In order for future agricultural development in accordance with those outlined in the Broad Outlines of State Policy in 1993, thus the general purpose of Kusuma Agro Tourism is as follows:

- a. Increase farmers' income and living standards
- b. Expanding employment and business opportunities
- c. Filling and expanding markets, both domestic and foreign markets
- d. Support the development of the region

In terms of serving visitors or tourists who come to tourist rides, Sindu Kusuma Edupark (SKE) provides service in earnest, This is evidenced by the consideration of the safety aspects of each vehicle that is in the SKE scope and is truly declared suitable to be played by children with certain height limits and adults who have no history of heart disease. Often tourists get information through leaflets, billboards and social media accounts from SKE, but not infrequently some of them often misunderstand or do not understand the promotions given by the manager, due to inaccuracies in reading information. For example, visitors do not know thoroughly the information related to ticket prices or packages and facilities that can be used on the package or give bonuses and discounts in certain months. Seeing the restlessness of the visitors, the management did not remain silent, well and kindly the managers, especially those in the marketing division, gave an explanation in accordance with the questions raised by the visitors or if the duty manager could directly go down the field to resolve complaints from visitors. Not only that, in terms of handling complaints from visitors, some of them also complained about the vehicles and facilities that were originally there, when they came to visit again, the rides were gone and vehicles that were not allowed to be played when the rainfall fell, also became one of the factors that causes visitors to be dissatisfied with the service at this SKE tour. In overcoming complaints or inaccuracies in delivering messages to visitors through media advertising can be done or handled by all departments because this is part of the problem of management to communicate information that in nature can confuse the existence of the company. What is usually done in dealing with issues that are not good is to bring the matter to the morning briefing, the agenda that is carried out every morning by the manager in a series of hearings from the employees and then find solutions or solutions to problems, so that the problem does not dissolve and then just disappear.

Bad events have also threatened the good name of SKE so that this greatly affects the process of activities in daily management activities in this tourist vehicle. Often the issue that arises is no longer in terms of ticket prices or discounts, but some of the visitors are desperate or bravely disobey the rules that have been stated in each game vehicle, for example by riding a vehicle that has a ban then visitors experience an accident so that this brings bad news for other visitors out there, but this issue was brushed aside by means of clarification from the SKE and gave full treatment to the victims of the Sindu Kusuma Edupark tourist rides, this was done to get a good response from the victims and family members concerned, although the error is not the

responsibility of the manager, but good faith is given at least to restore the good name of the company in the eyes of other tourists. This is in accordance with the drumming phasing process by Regeter & Larkin that in Issue Management is carried out at least through the right stages, starting with **identifying issue**: the problem that was the source of the problem related to the fall of visitors in one of the rides. The next stage is **issue analysis**: seeking information related to the inaccuracy or inadequacy of messages that visitors get or why accidents in vehicle rides can occur, who is involved in the accident and further information relating to the occurrence of an accident. The third stage in the management model of this issue is **the choice of strategies**, which at this stage involves experts to get the accuracy of information which will then be selected for strategic plans that are suitable for dealing with problems that occur and thus can be determined by **the program to handle the issue** by financing by way of 100% treatment of victims of accident vehicles within the scope of SKE, so that proper planning can restore the company's image and not become a widespread problem such as a crisis. But after the incident which slightly threatened the good name of SKE, the management **evaluated** each game vehicle by deploying an operational team to maintain and provide information regarding the rules and prohibitions to be understood by every visitor or tourist of Sindu Kusuma Edupark, so that similar incidents do not occur again .

In all activities carried out by the manager is based on actions and elements of communication, because it is the main principle for the initial decision to be forwarded to become a joint policy, especially things - matters relating to complaints of customers or tourists. Not only that, social campaign activities are also one of the activities of Shindu Kusuma Edupark's management to involve themselves in the community, the purpose is to have good cooperation from the closest people and is one way to introduce educational tourism to the surrounding community.

Conclusion

By looking at the data and information associated with the theory of management of the above issues, it can be concluded that no matter how small the problems complained by visitors or tourists Sindu Kusuma Edupark tourism vehicles are always well responded by the manager or Guest Service Attendant (GSA) and if there are problems which is not too crucial will soon be dealt with, but if the problems that are complained have an impact on the activities and performance of other employees, then this will be brought to a higher level, namely the duty manager to get a decision based on the results of the joint meeting so that the issue does not extend to society. With the morning brief which is a daily activity in the management of the Sindu Kusuma Edupark tour vehicle, it can become a common reference in solving the slightest problem. Thus management in an organization or agency, especially in this case is in the tourism sector industry can be planned from the beginning, since the establishment of the company, so that when facing problems, the team or division concerned can seriously manage complaints or problems with policies and strategies that right and organization or *instandi* can foster an always positive image to the public.

Reference

- Kriyantono, Rachmat. 2012. Public Relations & Crisis Management. Jakarta: Kencana Prenada Media Group
- Morissan. 2010. Public Relations Management. Jakarta: Kencana.
- Moleong, L. 2013. Metodologi Penelitian Kualitatif, Paradigma Baru Ilmu Komunikasi dan Ilmu Sosial Lainnya. PT. Remaja Rosdakarya. Bandung.
- Nova, Firsan. 2011. Crisis PR. Jakarta: PT. Raja Grafindo Persada
- Pawito. 2008. Penelitian Komunikasi Kualitatif. LKiS. Yogyakarta
- Ruslan Rosady. 2008. Kiat dan Strategi Kampanye Public Relations. Jakarta: PT. Raja Grafindo Persada
- Sutopo, H.B. 2006. Qualitative Research Methodology. Sebelas Maret University.
- Soemirat Soleh & Elvinaro Ardianto. 2005. Dasar-Dasar Public Relations. Bandung: PT. Remaja Rosdakarya

Journal

- Alina Filip. 2013. Complaint management: A customer satisfaction learning process. *Procedia - Social and Behavioral Sciences* 93. P271 – 275
- Handayani Kiki, Erman Anom. 2010. Peran PR Menerapkan Manajemen Krisis Dalam Memulihkan citra PT. Garuda Indonesia Pasca Kecelakaan Pesawat Boeing G.737/400 Di Yogyakarta. *Jurnal Komunikologi*. Volume 7. Nomor 1, Maret.
- Luhukay, Marsefio. 2008. Penerapan Manajemen Krisis Di Indonesia: Memotret Krisis Dalam Kacamata Public Relations. *Jurnal ilmiah Scriptura*. Volume 2. Nomor 1, Januari 2008.
- George Knox & Rutger van Oest 2014. Customer complaints and recovery effectiveness. *Journal of Marketing*. Vol. 78 (September 2014), 42–57

Online Media

<http://jogja.tribunnews.com/2018/09/18/hingga-juni-total-kunjungan-wisatawan-ke-kota-yogya-hampir-dua-juta-orang>. Retrieved April 5, 2019

<https://katadata.co.id/berita/2019/01/02/hingga-november-2018-sebanyak-143-juta-turis-asing-ke-indonesia>. Retrieved April 5, 2019

Sindu Kusuma Edupark document

Da'wah Materials Centralization as an Effective Guidance in Digital Era

Inta Hartaningtyas Rani
Accounting Department
Ahmad Dahlan Technological and Business Institute
Jakarta, Indonesia
intahartaningtyas@itb-ad.ac.id

Abd. Wahid Wijaya
Human Capital Department
Jakarta, Indonesia
abdul.wahidwijaya@corp.bri.co.id

Abstract— *The exponential growth of the digital technology has caused a culture shift in the way of accessing fast moved and unlimited information, including in accessing Da'wah. To avoid dissemination of heresy and radicalism, several efforts have been made by the Government, Institutions and Islamic Organizations such as forming websites, YouTube channels, and social media accounts. Da'wah Materials Centralization is an alternative solution that can be applied by official authorities (KEMENAG) which emphasizes the standardization of Da'wah content as a guidance to be followed by every Da'i, so that the materials delivered becomes more structured, qualified and standardized. The application of this system will also facilitate the educational materials needs and be an enrichment of study literatures. Da'wah material will be set periodically by providing soft files of PowerPoint slides that can be downloaded by users, so that the Da'wah process is more visually attractive and makes it easier to spread.*

Keywords— *Da'wah Materials, Centralization, Guidance, System*

Introduction

The digital revolution has occurred in various aspects of life in Indonesia and even in the world. The shift from conventional methods to digital methods has had an impact on people's lives that was well-known as disruption phenomena. For those who are able to adapt, the digital revolution will bring many conveniences and goodness. However, it can actually bring deviation and damage if it has been used in a wrong way.

Through the digital media, people easily share any digital content and ignore the ethics and effects that arise afterwards. The digital literacy skill which is very important for people to understand the content has not been owned by the most of users. This contrast situation will result in what they call a "sumbu pendek" generation in which people misunderstand, misuse and also are easily provoked by the information shared that could endanger the national unity.

In Islamic education field, *Da'wah* method also has been shifting to the dynamic *Da'wah* approach which is utilizing the benefit of digital media. The studies of Islam now can be unlimitedly accessed. There is no special time and place needed to share *Da'wah*. *Da'i* starts making the lecture online, and the numbers of *Da'wah* accounts and communities are significantly increase. Islamic education as an educational system, with an impressive and convincing strategy and method, plays an important role and has a huge contribution

in supporting the formation of national character (Anwar & Salim, 2019). *Da'wah* strives to establish a good character through the world of education. The existence of education itself aims to maintain and to develop the individual nature and potential towards the formation of a good human being. *Da'wah* communication according to Wahyu Ilaihi (2010) is the process of delivering information or messages from a person or group of people to a person or group of people originating from the Qur'an and Sunnah by using symbols both verbally and non-verbally in order to change attitudes, opinions, or other people's behavior better in line with Islamic way both directly through face to face lecture and indirectly through the media. With *Da'wah* that becomes more accessible, the knowledge of Islam spreads widely, and the purposes of developing Muslim that is strong in Aqeedah, Worship, and Character as well as the toughness in facing any challenges, obstacles and changes that arise in domestic, regional, national even in global circumstance are more realizable.

In the middle of transformation process the deviation rises in such a way that it will block out the achievement of those good purposes. Character formation process will lead to the wrong result. In the conventional method, psychological gap between *Da'i* and the audiences or other minor problem might be the cause that will reduce the effectiveness of *Da'wah* delivery process. However, in this momentum of digital era, the most horrible thing that can happen is when there is a set of people with bad intention trying to spread doctrine of heresy and to take the benefit by wrapping up their mission in the name of Islamic education.

"The real Muslim will remain stand strong in the right place even when the world is in chaos" is one of KH. Ahmad Dahlan messages, the founder of Muhammadiyah organization. However, the situation is that, Muslims have to find out solution and improve their capability continuously. The Religion Affair (KEMENAG) is the highest institution with the highest authority in Islamic issues in Indonesia. Different from those country whose the *Da'i* are standardized so they individually have a full responsibility of Their *Da'wah* and the effect to people, in Indonesia KEMENAG still has a duty to set the qualified systems to cover the purpose of *Da'wah* and protect it from any deviation. Bimas Islam (<https://bimasislam.kemenag.go.id/>) is an official webpage owned by Direktorat Jenderal Bimbingan Masyarakat Islam, one of KEMENAG division, in which it represent an

alternative solution provided by KEMENAG for people especially Muslim to access an accountable information. It also includes the cyber team which was intended to monitor and to persuade people avoiding drugs, pornography and radicalism.

Bimas Islam should be more explored and utilized for the good of Indonesian Muslim. It is not only for the existing menus, but it also can potentially be used for preventive action as well. It is like what Lai Yeung (2014) has said that the global trend seems to have moved from a casework and remedial approach to a preventive developmental approach in providing guidance and counseling, KEMENAG should consider to maintain the *Da'wah* content spread through various media both conventional and digital by making such a guidance in *Da'wah* delivery process.

By centralizing the *Da'wah* materials and covering it with systematic regulations and procedures, *Da'i* and the *Da'wah* process will be both controlled and directed in good way. This can be not only an alternative solution and even a preparation towards the official standardization for *Da'i* but also an enhancement to optimize the utilization of Bimas Islam webpage. Once the system is built and actively used, the database will provide information that can be used for any benefit. The effectiveness of *Da'wah* delivery process will be easier to measure and to track. For *Da'i*, this system will provide new media for knowledge transfer and sharing process, while the expert guides the newcomer and thus the *Da'wah* topic will not pass the boundary, Al Qur'an and As-Sunnah. *Da'wah* materials uploaded can be used for all good purposes; users can get accountable reference, study literature and Islamic knowledge.

The centralization of *Da'wah* materials is an interesting discussion as it is expected to be an alternative solution for the problems of the *Da'i* quality and the content of materials delivered. It is also expected to create people's comprehensive point of view regarding the straight and whole ways of Islam in this digital era.

Literature Review

Imam Syafi'i has quoted that whoever wants to win this world life, they should have knowledge, and whoever wants to win the afterlife, they also should have knowledge. Islamic education is a knowledge transformation media in religion aspect (cognitive aspects), and a morality transformation media in character building (affective aspects) that plays an important role to control behavior (psychomotor aspects) and thus to create an absolute human personality or well known as *insan kamil* (Anwar & Salim, 2019). This is where the function of *Da'wah* is needed, i.e. to nurture Muslim's mental and spiritual aspects in accordance with Al-Qur'an and As-Sunnah that produce Muslim generation with good character and morality.

Morals or character building is the top priority purpose in Islamic education, as it is also the main reason of Rasulullah PBUH teaching, "and indeed, you (Muhammad) are of a great moral character" (QS. Al-Qalam (68): 4). For a Muslim, striving to build a good moral is an integral part of striving to stand the faith in accordance with authentic hadith "A *Mukmin*

who has the most perfect faith in Allah, is the one who has the best morality" (HR. Bukhari).

Nnabuike (2012) notes that the work of the teacher is to help students to learn through deliberate and conscious manipulation of information, knowledge, skill, values, attitudes and habits of the learners in order to bring about learning which is leading to desirable changes in character. *Da'i* is a teacher in *Da'wah* process, so that *Da'i* should keep this reason and mission along his lecture, to build a good character and morality.

In communication science, *Da'wah* method is better known as an approach, which the ways of *Da'i* in achieving some goals based on wisdom and affection. *Da'wah* is the application of *amar ma'ruf nahi munkar* concept, the instruction to persuade people doing good things (positive-constructive) and leaving bad things at once (negative-destructive). According to Azis (2009:9), the functions of *Da'wah* are:

1. Spreading the messages to Muslim as individual and society so they can feel Islam really as *Rahmatan lil 'alamiin* for all Allah's creatures
2. Conserving the Islamic values and thoughts among Muslim generations continuously and uninterruptedly.
3. As a corrective action, rehabilitating bad morals, preventing harm, and taking humans out from spiritual darkness.

Maddah Da'wah (*Da'wah* materials) are messages that contain the truth and goodness sourced from Al- Qur'an and As-Sunnah told by *Da'i* to *Mad'u* (audiences). *Da'wah* materials involve the concepts of Aqeedah, Sharia, morality and their derivative thoughts (Syukir, 1983). Thus, discussing about *Da'wah* materials is discussing about the Islamic education itself. It is because all of the Islamic topics can be the source of *Da'wah* materials (Maddah) (Azis, 2009). By merging *Da'wah* materials centralization concept into Bimas Islam webpage menu, the *Da'wah* materials in power point slide form will be easily downloaded, spread and directly used with an attractive visualization which is expected to increase the *Da'wah* effectiveness.

The various objectives and components of *Da'wah* as explained above must continually be *Da'i* and KEMENAG's (as the authorities) concern to protect the *Da'wah* process from any deviation and to make sure that the process is functioned properly to get Allah's blessing. *Da'i* as a *Da'wah* subject must be able to adjust his character to direct the audience (*Da'wah* object) to the messages he tries to deliver and along with audience's experience, background and scope of knowledge thus the *Da'wah* purpose can be achieved as an effort to apply the values of Islam in their daily life (Syafi'i, 2018).

As formal education system in school, the Ministry of Education and Culture regulations no. 61 (2014) about the formulation and development process of Educational Unit Level Curriculum (KTSP) to be used as teaching guidelines have been issued. Thus, the learning process can be directed, controlled, standardized, achieved, and the deviation is still in an acceptable range. Teacher's effectiveness in using the instructional resources is considered important to enable them

to master the requisite knowledge of the subject matter content and to enhance their teaching capabilities (Orodho, 2013, 2014). Akinade (2012) defines guidance as a process of helping an individual to become fully aware of his/her self and the ways in which he is responding to the influences of his/her environment. It further assists him to establish some personal meanings for this behavior and to develop as well as to classify a set of goals and values for future behavior. Nnabuike (2012) believes that a teacher is also a learner because there is no end to learning. Through those references, *Da'i* as an educator and the *Da'wah* process as the educational circumstance will be more effectively delivered when it is enhanced with the guidance, standard procedure, good systems and proper regulator inside.

There is no previous study has been found regarding the application of *Da'wah* material centralization system as a guidance for *Da'i* in delivering *Da'wah*. This study is proportionally adapting the KTSP concept in educational system, combining with the application of Standard Operating Procedure (SOP) in the business activity and then covering it with any adjustment needed.

In addition, if it is concluded about the purposes of KTSP formation (attachment of mendikbud regulator) and SOP implementation (Fatimah, 2015), the combination of purposes can be seen as follows:

1. As a reference for each party in charge in carrying out his duties optimally
2. Facilitate coordination and supervision process
3. Minimize fraud and deviation
4. Simplify and reduce cost in providing training
5. Make the executor more independent, not depending on the regulator's interventions
6. As a standardization that can improve comparability, credibility and defensibility
7. Facilitate evaluation process and maintain the quality of work
8. As a neater administration that provides document that can be traced anytime

Da'wah materials centralization will be an effective guidance for *Da'i* just like KTSP implementation as guidance for school teacher. Moreover, by setting the appropriate procedures in using it, KEMENAG will take the control and preventive function.

Methodology

The method used in this study was a qualitative-descriptive method. Qualitative-descriptive method, according to Arikunto (2002), is intended to gather information about the status of existing phenomenon which is the actual condition of it at the time of the study. Therefore, the qualitative study is able to reveal the phenomena of the subject chosen to be deeply explored.

Regarding to the formation of *Da'wah* material centralization mechanism by KEMENAG, researchers analyzed the raw information (interview result) and then linked several finding phenomena to the theories and pervious study (if any) as a

unified interrelated context to be delivered in descriptive narrative form. This process is in line with interactive model of Miles and Huberman which consists of four steps, data collection, data reduction, evaluation and conclusions (Herdiansyah, 2010).

Interviews conducted in this study were structured and in-depth interview model with the interviewee selected based on their relevance, responsibility and authority in *Da'wah* management sector. The interviewees in this study are:

1. Bapak Drs. H.M Adnan Harahap (Head of *Da'wah* and *Takmir* Section in Istiqlal Mosque Jakarta)
2. Ibu Nofiarti (Section Head of *Da'wah* Area's Mapping and Data Collection Sub Directorate of *Da'wah* and Islamic Holidays in the Directorate of Islamic Information)

The study took place in Jakarta and the period of time was February until May 2019.

Result and Analysis

The primary data of this study were gathered from structured and in-depth interview with the related interviewees. From the first interviewee, Bapak Drs. H.M Adnan Harahap who is currently active as the Head of *Da'wah* and *Takmir* Section in Istiqlal Mosque Jakarta, the information collected are related to current *Da'wah* circumstance condition, and needs for improvement and recommendations. The second interviewee who was representing KEMENAG as the authorities, Ibu Nofiarti the Section Head of *Da'wah* Area's Mapping and Data Collection Sub Directorate of *Da'wah* and Islamic Holidays in the Directorate of Islamic Information provided the information about what has been done and what are the projects planned by KEMENAG to support and to organize the *Da'wah* attributes in the database needed for the process which remains scattered.

According to Bapak Drs. H.M Adnan Harahap, Indonesia nowadays through KEMENAG has started the effort toward *Da'wah* process standardization, but due to the unclear *Da'i* criteria and the communication failure, the process was temporarily suspended. The other social problems that arise along the process, are:

1. People have their own and various criteria about *Da'i*
2. Standardization efforts are still considered as a step that will limit the *Da'wah* movement considering the diversity problems in each area that are varies.
3. There is a bias perception between the functions of *Da'i* and those of the Elders or public figures who have great influence in the area

Additional issue of the *Da'wah* standardization is the wide access to information in this post trust era as a challenge for *Da'i* in Indonesia. People easily share and spread the pieces of *Da'wah* content that are fragmented, edited and disseminated for certain provocative purposes. Online media are also creating the instantaneous culture for people in accessing information, various knowledge sources, and the originality and accountability of information that are questionable. Furthermore, the easy circulation of negative information, pornography, radicalism and misleading

information are also becoming a major challenge for the duty of *Da'i* and people in society to stay in line with Islamic values.

Standardization become an important issue as Indonesia needs support from *Da'wah* personnels (*Da'i*) who have good capacity and credibility in spreading Islamic thought. The standardization can be done in several ways, referring to the steps taken by most of the large mosques that have been implementing the standardization:

1. Education and training for *Da'i*. They are kinds of debriefing the standard knowledge of a *Da'i* before practicing in the society, such as the concepts of aqeedah, fiqh, and other basic study
2. *Da'i* regeneration. It is the activity of the senior *Da'i* to guide other candidates as regents continually, so they are saved from the *Da'i* shortages in their area
3. *Da'wah* materials. It is not only the readiness of the *Da'i* personally who will optimize *Da'wah* delivery process, but also the content which will be delivered is mainly on the latest strategic issue

Related to the concept of *Da'wah* materials centralization, Bapak Drs. H.M Adnan Harahap said that it was indeed needed, especially when people in this chaos need to be re-unified with the same understanding about sociological problems such as heresy and the dangers of radicalism. He recommends that the *Da'wah* materials centralization system still provides an improvisation space for *Da'i* to adjust and to adapt the content into the condition and issue of each *Da'wah* area.

Ibu Nofianti as Section Head of *Da'wah* Area's Mapping and Data Collection Sub Directorate of *Da'wah* and Islamic Holidays in the Directorate of Islamic Information believes that the *Da'wah* project progressed by KEMENAG this far is quite appropriate, starting from Mei 2018 KEMENAG has been mapping *Da'i* into the areas that lack of personnel, to database forming of *Da'i* from all areas of Indonesia. In its implementation, there are some kinds of constraints especially in forming the database, such as standardization of criteria, compliance and commitment of regional office to submit the data, and other various technical matters.

Responding to Bapak Adnan's reference about the steps taken by most of large mosques that have been implementing the standardization, Ibu Nofianti gives the information that:

1. for the concern no.1, KEMENAG has had given the training for *Da'i* who was chosen to represent his area. The training materials consist of socialization about *Da'wah* themes, how to use *Da'wah* media effectively and properly, and kinds of personality that *Da'i* should have. This training is expected to be held periodically in the years ahead.
2. For *Da'i* regeneration concern, KEMENAG has their part named as "*Penyuluh*" who are group of beginner *Da'i*. They are located to the regional office, trained and practiced to be professional *Da'i*.
3. In relation to the *Da'wah* materials centralization, KEMENAG's webpage which is an easy access for people is available at

<https://bimasislam.KEMENAG.go.id/pustakadigital> that already contains some material and studies. The materials updated were carried out directly by the Bimas team in the form of dictate or books and were published lately in 2017. Besides *Pustaka* Digital menu, there is *Da'wah* Islam menu that consists of the data related to *Da'i* and *Da'wah* area which has not been fully updated by related information. However, this is not technically enough to cover the needs of materials centralization, but it has showed that KEMENAG is heading to the materials centralization process.

Flowchart below shows the existing flow of *Da'wah* Materials organized by KEMENAG through the Bimas Islam webpage.

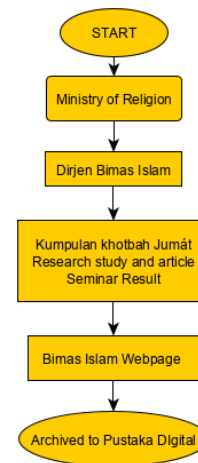

Figure 1. Existing Flow of *Da'wah* Materials Organized by KEMENAG in Bimas Islam Webpage

From the information collected from the interviewees, passing the reduction and evaluation process, what has been explained above are the results of information needed to support the completion of *Da'wah* materials centralization system as the aims of this study. This system is expected to be a preparation task towards the official standardization for *Da'i*. The project will be in the form of an IT enhancement that will optimize the utilization of Bimas Islam webpage. The materials uploaded will be the guidance for all *Da'i* to deliver *Da'wah* synchronously in various areas. The data gathered once in the system which is actively run can be used for another database formation need. The new *Da'wah* materials flow proposed is involving *Da'wah* materials centralization system as shown in the flowchart below.

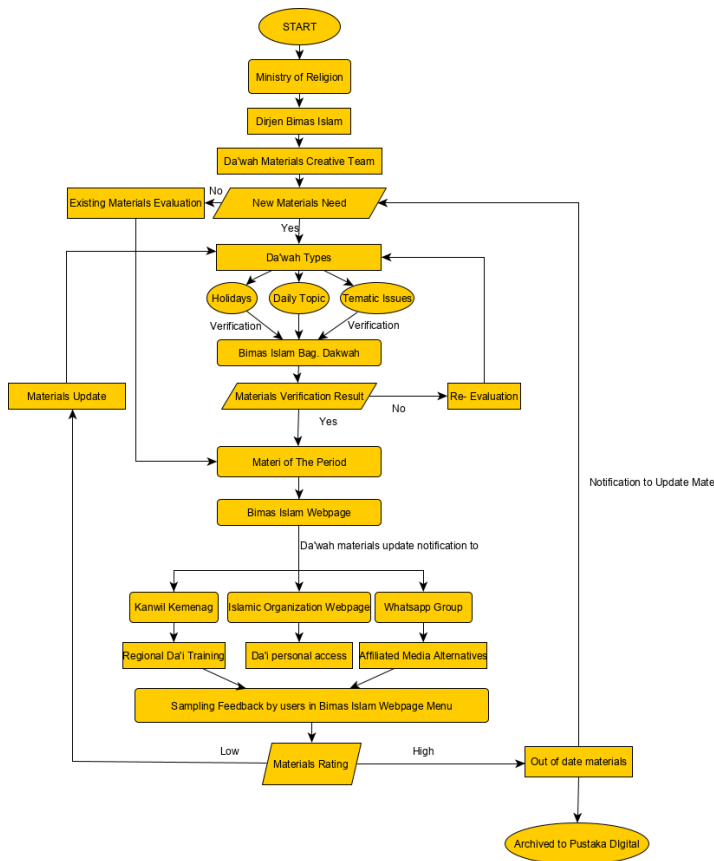

Figure 2. New Flow of *Da'wah* Materials Centralization Proposed

The flowchart illustrates the implementation of *Da'wah* material centralization through the Bimas Islam webpage. The detail explanations of the flowchart, are:

- a. KEMENAG is the highest authority that is in charge to set regulation and policies for the creative team that makes the *Da'wah* materials. This is intended to produce the *Da'wah* materials which is under the government's control as the regulator thus the deviation, SARA issues and heretical sect are not easily infiltrate into public consumption.
- b. The creative team compiling *Da'wah* material under the supervision of the director general of Bimas Islam can consist of several components such as:
 - the head office of KEMENAG
 - representative team of an Islamic Organization
 - team of MUI's *Da'wah* division
 - Islamic figure respected in the society or the representative of related ministry
 Each member of the team was given a Decree of the Director General of Bimas Islam after going through the fit and proper test stages set by the committee
- c. To start preparing *Da'wah* materials, the team should check the existing materials in digital *pustaka* database first. If the existing materials is relevant to the *Da'wah* event or time period, such as a routine lecture, then the existing materials can be directly used and uploaded as Material of the Period in the Bimas Islam webpage.

- d. If the *Da'wah* material requires the preparation of a new one, previously the team should determine the type of *Da'wah* category that consists of three types to be chosen:
 - Holidays (*Hari Raya*), is a material that can be used by all *Da'i* in Indonesia when presenting *Da'wah* on major Islamic events (Eid al-Fitr, Iduladha, Nuzulul Quran, Isra Miraj, etc.). The materials will be uploaded annually, a month before the event at the latest.
 - Daily topic for routine studies, is material that can be used for routine *Da'wah* (Friday khatbah, marriage preaching, death, etc.). The materials will be uploaded quarterly, a month before the event at the latest.
 - Thematic Issue is incidental materialization that depends on issues that occurred currently; getting along with the most update conditions in the local area and the country (the importance of an election period, *muhasabah* facing a certain disaster, etc.). the material will be uploaded a day after the incidental event at the latest.
- e. Final draft of new *Da'wah* material made should be verified by *Da'wah* section of Bimas Islam to decide if the material can directly be used or needs more revision. The revision process will repeat the previous step. If the results of the verification have met with criteria and are worth sharing, it will be uploaded into the Bimas Islam webpage in the "Material of The Period" sub menu inside the *Da'wah* Islam menu. File uploaded is in power point slide format to make the *Da'wah* more attractive and easy to spread.
- f. Parallel with the successful process of uploading *Da'wah* material in the Bimas Islamic webpage, a notification announcing the new update with weblink to directly access the update in the Bimas Islam webpage will be sent to several communication media, owned by:
 - KEMENAG regional office. The material can be used as an update material for local *Da'i* training, and can be spread through internal group of local *Da'i*.
 - The Ormas Islam webpage. In order to benefit from the KEMENAG's affiliation with Islamic organizations, the spread of material can also use online media or networks owned by mass organizations (mirroring upload)
 - Whatsapp Group. It is as an informal media whose effectiveness in spreading information has been proven.
- g. "Material of The Period" is the most updated material that is allowed to be used by the *Da'i* to be delivered in their *Da'wah* section. For the out of date *Da'wah* materials, they will be automatically archived into *Pustaka Digital* database and will be displayed in *Pustaka Islam* submenu.
- h. As a function of control and refinement of materials, *Da'i* can give comment and ratings to the materials that have been uploaded. The feedback will be the evaluation tool. If the rating is high from feedback results, the material can be archived in the *Pustaka Digital* database and will be displayed in *Pustaka Islam* submenu (out of date materials).

- i. Regarding *Da'wah* material that has a low rating, it will be treated as existing materials that needs improvement in line with the *Da'i* input, and it will repeat step c and d to be re uploaded when the event is relevant to the materials. To reflect a real illustration of an enhancement system of Bimas Islam webpage, this study is providing the prototype of the display menu after being added with the new flow of *Da'wah* materials centralization system.
1. In the existing display menu of Bimas Islam webpage, the enhancement will take place in the *Da'wah* Islam and *Pustaka Digital* menus.

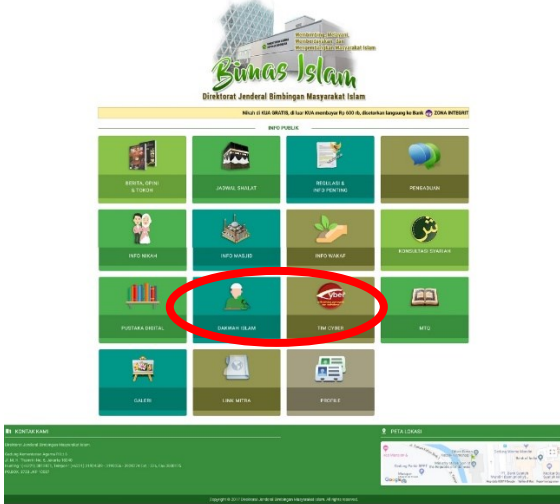

Figure 3. existing menu display of Bimas Islam Webpage

2. Additional sub menu will be added under the *Da'wah* Islam menu,

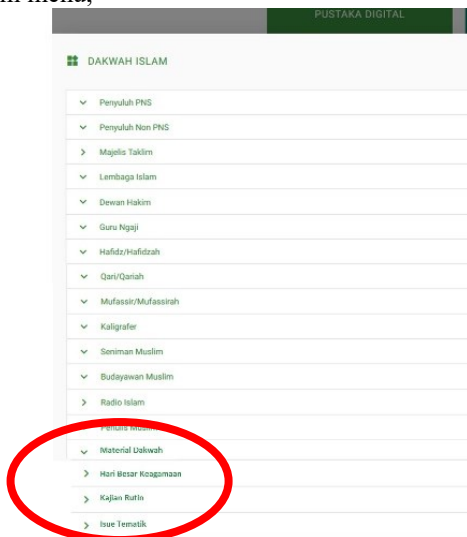

Figure 4. additional sub menu under *Da'wah* Islam menu

Da'wah materials that can be accessed and downloaded by the *Da'i* will be in line with the categories described in the previous section, Religious Holidays, Daily Topic (Routine Studies), and Thematic Issues. In each material that has been uploaded as an evaluation tool and *Da'i*'s input, there are several additional columns that can be seen below:

1. Comment column: the field for *Da'i* to input argument or suggestion about *Da'wah* materials. This field format is free text and has no maximum character.
2. Rating: each material can be rated by the *Da'i*, so from the response, the material which needs improvement can be determined or can directly be archived as *Pustaka Digital*.
3. Column of Suggestions / Critics: Columns that can be filled in with any input about the circumstance of *Da'wah* materials menu, out of date materials and any other comment.

This representative illustration and explanation is aimed to clear up the concept of *Da'wah* materials centralization as an effective guidance in digital era.

Conclusion and Recommendation

Da'wah materials centralization carried out by the ministry (KEMENAG) through Bimas Islam web page as guidance for *Da'i* which was proposed in this study is a preventive and control way from the highest institution to maintain the quality of *Da'wah* and to minimize the deviation of good purposes of *Da'wah*. This study is focused on the design of *Da'wah* materials centralization system and its implementation procedures. The raw data based on the information given by the interviewees are merged with the literature review about Educational Unit Level Curriculum (KTSP) and Standard Operating Procedures (SOP) system to create the systematic and structured *Da'wah* materials centralization system flowchart. In a simple way, the flowchart tells that with such procedures and regulations involved, the *Da'wah* material will be set periodically by providing soft files of PowerPoint slides uploaded to Bimas Islam webpage that can be downloaded by users and people to make the *Da'wah* process more visually attractive and makes the material easier to responsibly spread.

If the lack of digital literacy skill, the high level of *Da'wah* deviation, the increase in number of radicalism and heresy issues in digital era are not treated well, they will cause more chaotic situation and endanger the national unity. Government needs a move to reduce the misunderstanding in Islam perspective. The centralization of *Da'wah* materials that creates standardized circumstance will at least help to synchronize the perception of the people about Islam.

The research result should be deeply explored, developed and complemented by appropriate regulation to be launched by the authorities. With a good coordination and commitment of all parties, this simple innovation can be implemented by utilizing the existing resources (Bimas Islam webpage). This research result can also be the reference for further research in the same major.

After the establishment of the database, the control function can be done by the system with the uploading activity method or other methods. As for the related system and regulations applied, it is expected to be evaluated periodically and improved continuously to get along with the world changes.

REFERENCES

(a) Books

- [1] Akinade, E. A. (2012). *Modern Behaviour modification, principles and practices*. Ibadan: Bright Way Publishers.
- [2] Arikunto, Suharsimi. (2002). *Prosedur Penelitian: Suatu Pendekatan Praktek*. Jakarta: Rineka Cipta.
- [3] Aziz, Ali. (2009). *Ilmu Da'wah*. Jakarta: Kencana Prenada Media Group.
- [4] Fatimah, E. N. (2015). *Strategi Pintar Menyusun SOP*. Yogyakarta: Pustaka Baru Press.
- [5] Husaini, A. (2010). *Pendidikan Islam Membangun Manusia Berkarakter dan Beradab*. Bogor: Insists.
- [6] Ila'hi, Wahyu. (2010). *Komunikasi Da'wah*. Jakarta: PT. Remaja Rosdakarya
- [7] Majid, A., & Andayani, D. (2012). *Pendidikan Karakter Perspektif Islam*. Bandung: Remaja Rosda karya
- [8] Nnabuike, E. K. (2012). *Practical Guide to effective Teaching*. Enugu: Hallmark publishers.
- [9] Orodho, A. J. (2013). *Techniques of Writing Proposals and Research Reports in Education and Social Science Research Methods: Maseno*. Kenya: Kanezja Publishers.
- [10] Syukir, Asmuni. (1983). *Dasar-dasar strategi Da'wah Islam*. Surabaya: Al-Ikhlash.
- [11] Yaqub, Ali Mustafa Yaqub (2008). *Sejarah dan Metode Da'wah Nabi* Jakarta: Pustaka Firdaus

(b) Journal Article

- [1] Anwar, Syaiful & Salim, Agus. (2019). Pendidikan Islam dalam Membangun Karakter Bangsa di Era Milenial. *Al-Tadzkiyyah: Jurnal Pendidikan Islam*. 9. 233. 10.24042/atjpi.v9i2.3628.
- [2] Arifuddin. (2016). Da'wah through internet: Challenges and Opportunities for Islamic Research in Indonesia. *Ar-Raniry: International Journal of Islamic Studies*. 3 (1).
- [3] Lai-Yeung, S. W. C. (2014). The need for guidance and counselling training for teachers. *Procedia-Social and Behavioral Sciences*, 113, 36–43. doi: 10.1016/j.sbspro.2014.01.008.
- [4] Muhammad Takdir Illahi, Revitalisasi Pendidikan Berbasis Moral, (Yogyakarta: Ar-Ruzz Media). Hlm 25
- [5] Nkechi Theresa, Egenti. (2016). The role of Guidance and Counselling in effective teaching and learning in schools.
- [6] Orodho, A. J. (2014). Policies on free primary and secondary education in East Africa: Are Kenya and Tanzania on course to attain Education for All (EFA) Goals by 2015?. *International Organization of Scientific Research (IOSR) Journal of Humanities and Social Sciences (IOSR-JHSS)* 19(I), 11-20.
- [7] Shobahiya, M., & Suseno, A. (2013). Konsep Pendidikan Karakter Berbasis Potensi Diri dalam Film The Miracle Worker. *Suhuf*, 25(1), 76–99.

(c) Research Report

- [1] Syafi'i, Ahmad Imam. (2018). *Komunikasi Da'wah dalam Pembentukan Santri yang Berkarakter pada Pondok Pesantren Darul Ulum Seputih Banyak Lampung Tengah (Bachelor Essay)*. Universitas Islam Negeri Raden Intan.

(d) Website material

- [1] **Kementrian Agama. (2014). Peraturan Menteri Pendidikan dan Kebudayaan Nomor 61 tahun 2014 tentang Kurikulum Tingkat Satuan Pendidikan. Indonesia: Author. Retrieved April 22, 2019, from <http://simpuh.KEMENAG.go.id/regulasi/permendikbud/61-14.pdf>**

Contradiction of the Disruption Era: Does Disruption Affect Public Policy and Political Interests in Indonesia?

Syarifah Adinda Nadyawendi

Department of Government Affairs and Administration

Universitas Muhammadiyah Yogyakarta

Yogyakarta, Indonesia

adindanad@gmail.com

Abstract—The development of the current era of disruption has resulted in changes in global and exponential patterns where speed is higher, and the direction is difficult to predict, not only affecting economic actors but also influencing the decision-makers and the performance of the government. Whereas the public policymaking is still in linear pattern, resulting in slow decision-making process and failure in anticipating the disruption. The paper aims to find out whether the disruptive era influences government policy and or political interests. Cases discussed in this paper are the Terrorism Act and the Music Bill in Indonesia. In the case of the release of Abu Bakar Ba'asyir, a humanist-based policy seemed unstable to implement. Meanwhile, the discussion regarding the Music Bill was not deliberate enough among the actors. This paper uses descriptive-qualitative approach with library research as the data collection methods. This research provides suggestions for the government in anticipating the disruptive factors for policy-making process in the future.

Keywords— *Disruptive Era, Public Policy, Terrorism Act, Music Bill.*

I. INTRODUCTION

We have felt the impact of Industrial Revolution 4.0 as a development of modern civilization on various aspects of life, the penetration of technology that is all disruptive, makes change faster, as a consequence of the phenomenon of the Internet of Things (IoT), big data, automation, robotics, cloud computing, intelligence artificial (Artificial Intelligence). The disruption phenomenon that characterizes the development of the Industrial Revolution 4.0 civilization, with the support of rapid technological advances, will lead us to the conditions of the transition of the technological revolution that will fundamentally change the way of life, work, and organizational relations in dealing with each other.

Changes in the landscape of political economy and organizational relations because of the Industrial Revolution 4.0 make the transformation of government organizations a necessity in various scales of scope and complexity. This transformation of government organizations is an issue that must continue to be addressed as an instrument for government officials to be responsive to change. The acceleration of government organizations transformations is increasingly relevant in reference to the opinion of Klaus Schwab,

Executive Chairman of the World Economic Forum, who hypothesizes that with billions of people are connected to mobile devices and the discovery of byte-by-byte internet data processing speed, has increased human knowledge capacity exceeds conventional systems (Cahyono, 2018).

When the business has carried on a few steps ahead, even running at a fast pace, the regulations remain stagnant and continue to stay where they are and at times delay doing something until an event occurred, and the new government is shocked when problems arise. Examples of cases of online transportation, which have been going on for quite a long time in some of these countries, have still not been able to be anticipated by policymakers when they start operating in Indonesia. As usual, when the problem grows, governments just give a knee-jerk reaction.

Meanwhile, the future development of the business which is supported by advances in information technology is predicted to be increasingly fiercer and no longer in linear but exponential. It gives birth to the time called as the disruptive era. This phenomenon has become a global megatrend known as the abbreviation VUCA (volatility, uncertainty, complexity, ambiguity) (Baderi, 2017). To regulate online taxis, the government has made several laws and regulations, but putting it in place had been difficult with the resistance and protests staged by the applicators through their partners.

Consequently, the Minister of Transportation Regulation (PM) Number 32 of 2016 must be revised to PM Number 26 of 2017. The later was rejected by the Supreme Court. The subsequent PM No. 108 of 2017, which was finally annulled by the Supreme Court through decision No. 15 P/HUM/2018 dated May 31, 2018 (Pambagio, 2018). It is apparent that the annulment of transportation regulation (the Road and Transportation Law) by the Supreme Court (MA) was due to the characteristics of the regulation which cannot cope the myriad issues and the rapid progress of the industry.

Another case in relation to the policymaking occurred recently was the cancellation of the release of the convicted terrorist, Abu Bakar Ba'asyir⁷ on January 22, 2019. Ba'asyir was sentenced to 15 years in prison in 2011 and ailing in the Gunung Sindur Penitentiary, Bogor, West Java. According to Yusril⁸, Jokowi whom he met before the presidential debate,

⁷ Abu Bakar Ba'asyir, Ba'asyir as spiritual head of Jemaah Islamiyah (JI), a militant Islamic separatist group that has links to al-Qaeda, convicted as a network of terrorism cases

⁸ Yusril Ihza Mahendra, a lawyer, constitutional law expert, politician, and Indonesian intellectual. He has served as Minister of Justice and Human Rights and Minister of Secretariat of Indonesia

said he was sorry for the health condition of the 81-year-old Abu Bakar Ba'asyir.

According to Ade⁹, Ba'asyir was convicted with a terrorism case with a sentence of 15 years in prison. Therefore, the maturity of his pure release period is still long, which is on December 24, 2023 (Ade Ridwan, Vindry, dan M Taufiq, 2019). The release of Abu Bakar Ba'asyir was a presidential decree using humanitarian reasons which were finally canceled because Ba'asyir did not want to sign a statement of loyalty to the NKRI (Unitary State of the Republic of Indonesia). The decision of President Joko Widodo (Jokowi) who canceled the release of terrorist convict Abu Bakar Ba'asyir also raised the questions from the public.

Another case that shows Jokowi's governance is increasingly grumbling is the music bill that has been questioned lately by Indonesian musicians. This draft was planned to be compiled in February 2019 and will be followed up soon. However, many of the articles that will be proclaimed in this bill are controversial and burdensome to Indonesian musician.

Based on statistical data and the results of the Bekraf¹⁰ survey with BPS¹¹ released last year, the contribution of the music industry in the creative economy income is still at 0.47% or around Rp 5-6 trillion from the total GDP of Rp1,000 trillion. While the fashion sub-sector dominates around half the portion of the creative economy GDP or around 56%, it is followed by craft arts sub-sector (37%) and culinary (6%) (M Imaduddin, Azis Husaini, 2019). Many musicians think that this bill was made not in accordance with the needs and cooperation of fellow musicians. As a result, musicians in Indonesia explicitly reject the existence of this draft music bill. As a result, many musicians who rejected the draft law were referred to the Representatives (DPR).

With local and linear patterns, we often see the slow response and irresponsive decision-maker to the progress in public. Policymakers need a new mindset to launch policies in the disruptive era like today. We must be able to adapt quickly and recognize how the present situation is ever-changing. It is no longer just changing, but immediately shifts or replaces those who have stood before, fast.

With the various phenomenon of technological progress and their impact, it is evident that the urgency for the transformation of government organizations to answer the demands of public accountability and transparency is increasingly high today due to the development of the Industrial Revolution 4.0 era. Well, during changes in global and exponential patterns, where the speed is getting higher, and the direction is difficult to predict, the speed not only has an impact on economic actors but also affects the government's decision-makers and performance. The question is how to model the right public policy so that it still has positive implications for the government's performance?

⁹Ade Kusmanto, Head of Public Relations of the Directorate General of Corrections (DITJEN PAS).
¹⁰ BEKRAF (The Creative Economy Agency) is a non-ministerial government institution that is under and is responsible to the President through the minister responsible for the development of the creative economy in Indonesia.

II. THEORETICAL FRAMEWORK

This research will establish two main analytical frameworks. First is explaining theories on disruption era. It is used to describe the disruptive dilemma, knowledge, and opinion. Followed by the theory of public policy and political interests. It is set to describe the correlation of political interests in the public policy making in the destructive era.

A. Disruption

Harvard Business School, **Clayton M. Christensen**, in his book "The Innovator Dilemma (1997)" stated that disruption is a significant change in which large companies and even the incumbent leaders can be defeated by smaller companies, even though the small company loses funds and human resources. (Eriyanto, 2018).

So, according to Christensen's model, disruption is a model of thinking, and we need to understand it correctly. The term disruption is not the same as digital disruption. Digital Disruption is the involvement of digital technology in business

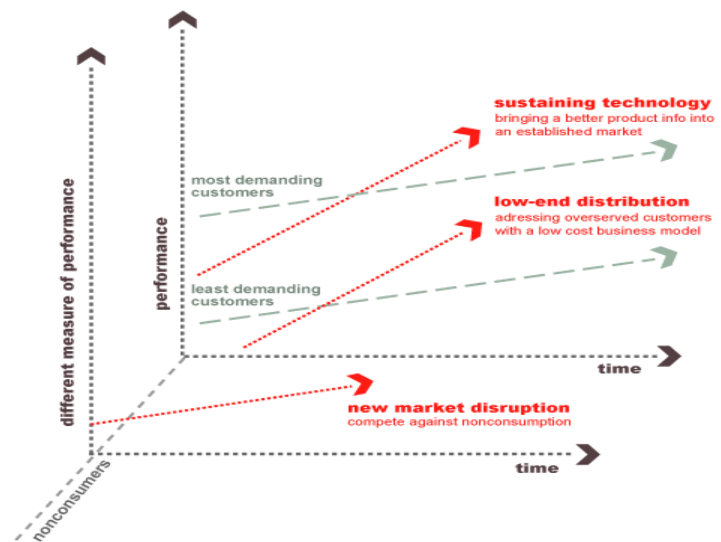

Figure 1. Christensen's Model of Disruptive Innovation in (Roger C. Brackin, Michael J. Jackson, Andrew Leyshon and Jeremy G. Morley, 2019)

operations that can change or remodel an old order and bring something genuinely new and even be able to override old technology.

Francis Fukuyama, the author of the book *The Great Disruption*, sees a phenomenon and event of disruption as the lexical meaning of the word. Disruption is seen as a shock that destabilizes social order in society. The development of increasingly radical information technology is an indicator that makes Fukuyama see this era as an era of disruption.

Everything feels close and available. Fukuyama does not forbid the use of information technology. Fukuyama views that people who are controlled by the power of information in this era tend to respect the values that are upheld in democracy; they are freedom and equality. Freedom chooses to stick high as a right, while all types of hierarchy (in religion, politics,

¹¹ BPS is Central Bureau of Statistics

government, business, and others) are undermined by the power of regulation and its coercive tendencies (Roja, 2018).

The phenomenon of disruption has pushed the global world to think about how to apply the science of "the future" under "present" conditions. **Rhenald Khasali** in his book *Disruption* nicely illustrates the phenomenon of disruption as an innovation, which will replace the entire old system in new ways, disruption will replace old technology that is all physical with digital technology that produces something wholly new and more efficient, also more useful (Cahyono, 2017).

Thus, the era of disruption is a social and technological change that can affect the excellent condition of the community as well as in the government. Adaptation is something that needs to be done by individuals and groups to form an organization development that is integrated with information technology to lead to the pattern of digitalization.

B. Public Policy

Carl J Federick as stated in (Agustino, 2008) define policy as a series of actions/activities proposed by a person, group or government in a particular environment where there are obstacles (difficulties) and opportunities for implementing the proposed policy in order to achieve specific goals. This opinion also shows that the idea of policy involves behavior that has a purpose and purpose is an essential part of the definition of the policy because after all, it must show what it can address rather than proposing activities to resolve a problem.

Harold Laswell and **Abraham Kaplan** define as a program projected with specific goals, specific values, and specific practices (H.A.R Tilaar & Riant Nugroho, 2012). Laswell describes several stages or processes in making public policy. The sequence is intelligence (collecting and processing various opinions from the policy-making process), promotion (choosing several options), prescription (determining actions), Invocation (approval of sanctions), application (implemented), termination (termination), and appraisal (assessment or evaluation) (Widyatama, 2015).

Anderson (1975) stated that public policy is a policy built by government agencies and officials where the implications of the policy are:

1. Public policy always has a specific goal or has goals-oriented actions.
2. Public policy contains government actions.
3. Public policy is what the government actually does, so it is not what is still intended to be done.
4. Public policy taken can be positive in the sense that it is a government action regarding all specific problems, or negative in the sense that it is the government's decision not to do something.
5. Government policies, at least in a positive sense, are based on binding and compelling laws.

Thomas Dye (1958) define public policy as "Whatever governments choose to do or not to do" that is, everything or anything has been chosen by the government to be done or not done. Dye also interpreted the public policy as an effort to find out what the government did, why they did it, and what caused them to do it differently. He also said that if the government

chooses to take action, then the action must have a purpose. This public policy must cover all government actions, not just the wishes or government officials. Besides that, something that was not implemented by the government included public policy. It is because something that is not done by the government will have as much influence as something done by the government (Michael Howlett and Ramesh, 1995).

According to **Thomas R. Dye** in **Dunn** (2000), three policy elements make up the policy system. Dye described the three elements of the policy as public policies, policy actors or stakeholders, and the policy environment.

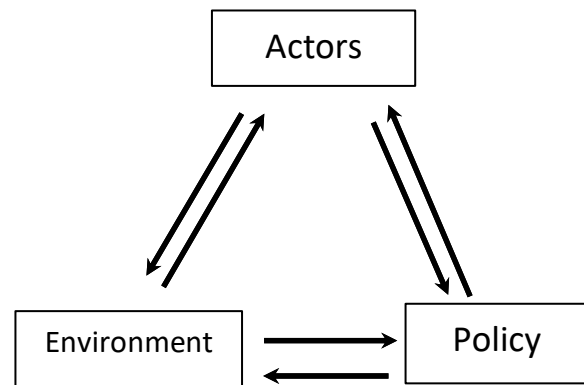

Figure 2. Cycle of Process of a policy according to Thomas R. Dye in Dunn.

Based on its stratification, public policy can be seen from three levels, namely general policy (strategy), managerial policy, and operational, technical policies. Also, from a management standpoint, the work process of public policy can be seen as a series of activities which include (a) policymaking, (b) implementation and control, and (c) policy evaluation.

C. Public Policy Process

According to **Anderson** and **Dunn**, the process of policy analysis is a series of activities in the process of political activities. Political activity is interpreted as a policy-making process and visualized as a series of interdependent stages (H.A.R Tilaar dan Riant Nugroho, 2012), they are; Policy agenda, Policy formulation, Policy adoption, Policy implementation, and Policy evaluation.

Dye put forward the stages of the policy process as follows: (a) Identification of policy problem, (b) Agenda setting, (c) Policy formulation, (c) Policy legitimation, (d) Policy implementation, and (e) Policy evaluation (H.A.R Tilaar dan Riant Nugroho, 2008).

III. RESEARCH METHOD

This research employed a descriptive research method, which is a method that discusses some possibilities to solve actual problems by collecting data, compiling or classifying, analyzing, and interpreting. Data collection techniques conducted in this paper is by way of literature study. In this case, the writer obtained the data by identifying the contents of the library material in the form of laws and regulations, scientific works, articles from the internet, journals, and books in the scope of the case of the release of Abu Bakar Ba'asyir from the terrorism act and in the case of Music Bill in 2019. The descriptive analysis method is adopted by describing the

facts which then followed by analysis, not merely elaborate, but also provide enough understanding and explanation. This paper uses the steps as recommended by Miles and Huberman's method, such as Data collection, Data reduction, Display data and Conclusion

IV. DISCUSSION AND RESULT

A. *The Polemics of Draft Bill of Music in Legislation National Program 2019*

February 3, 2019, Indonesia is fussed with the news of the draft bill that has entered the 2019 national legislation program. March 30, 2019, Commission XI of the Indonesian House of Representatives holds a Public Hearings Meeting (RDPU) with the Association of Indonesian Recorders, Songwriters and Music Designers Indonesian Recording Industry Association (ASIRI), Indonesian Recording Entrepreneurs Association (APRI), Association of Indonesian Music Publishers (APMINDO), Royal Anugrah Indonesia (RAI), Indonesian Cipta Karya Foundation (KCI), Wahana Musik Indonesia (WAMI) and National Collective Management Institute (LMKN), related to the latest developments in the Indonesian music industry. The meeting is an open meeting for the public (Prabowo, 2019).

As the results of the meeting, 260 Indonesian musicians rejected this bill in March 2019 (Irfani, 2019). With or without official government regulations (laws), the position of music artists is always in a vulnerable position. History shows how, in the context of public life, big things often burden the music industry.

Koalisi Nasional Tolak RUU Permusikan (The National Coalition Against the Music Bill) is a coalition formed by many Indonesian music practitioners who rejected the Draft Law from being stipulated. This coalition consists of 262 music practitioners. They stated that the bill holds many fundamental problems that limit and hinder the development of the creation process, in addition to potentially repressing music workers (Koalisi Nasional Tolak RUU Permusikan, 2019). The National Coalition Rejects the Draft Law on the view that the Draft Law on Draft Law contains many articles that overlap with several existing laws such as Copyright Law, Handover Act on Print and Record Works, and Law on Information and Electronic Transactions.

The making of this music bill has become a polemic for musicians to consider into the National Legislation Program. Although some of the articles in this law are against the wishes of the musicians, the coalition asks for the revocation of the bill from the 2019 National Legislation Program and not only corrected. The purpose and foundation of the drafting of this bill are vague and robust, which would potentially burn the development of Indonesian music activities. Furthermore, there is no urgency for the House of Representatives and the Government to discuss and ratify it. The script should align with the existing relevant laws.

The reality of music has become an industry that has high economic value at present, moreover, with the current era of globalization, the issue of music has become increasingly difficult when faced with technological developments that are full of dynamics and innovation. This bill is one of the policies proposed to become a national legislation program in 2019. This policy paper has gone through the process of making public policy by identifying problems that occur in the

Indonesian music industry. However, this policy does not underlie the interests of Indonesian musicians, but rather the interests of a handful of actors. The Creative Economy Agency (BEKRAF) is currently a benchmark for the creation of creative actors, one of which is through discussion. It is a critical headline to be considered by employers this year.

In this increasingly progressive era, overlapping policies will harm the policymakers. One of them is this music bill policy. If this bill is scheduled to become a national legislation program in 2019, then on what basis is it and what this bill is maintained. When referring to the global music industry, maybe the Indonesian government must learn about the rules about music from other countries. The government must also pay attention to the impact that Indonesian musicians will receive. Alternatively, in a more concrete, the government is working with legendary musicians to reach consensus in order to design a truer music law. This music bill is one of the policies of the House of Representatives, which overlaps with other laws and polemics for the actors.

B. *The Implementation of Terrorism Act and the Polemics of Releasing of Abu Bakar Ba'asyir 2019.*

January 2019, President Widodo's decision to approve the release of the founder of the Jamaah Anshorut Tauhid (JAT), Abu Bakar Ba'asyir, has drawn a polemic. Criminal law expert from Trisakti University, Abdul Fickar Hadjar, said that Indonesia did not recognize unconditional release. He conveyed this message on the unconditional release of convicted terrorist Abu Bakar Ba'asyir, who was approved by President Joko Widodo, for humanitarian reasons and health factors (Halim, 2019).

The director of the Deradicalization of the National Agency for Combating Terrorism (BNPT), Irfan Idris, stated that he had no problem with the release of Abu Bakar Ba'asyir who was considered to be quite old. However, Ba'asyir's terrorist network is his concern. He has been in prison since being convicted for proven funding of terrorist training in Aceh and supporting terrorism in Indonesia in 2011. Previously, following the Bali bombing in 2002, Ba'asyir was also named a suspect and sentenced to two years and six months after being declared conspiratorial in the terrorism case.

The Institute for Criminal Justice Reform (ICJR) researcher Maidina Rahmawati doubted the president's decision to use humanitarian reasons for the release of Ba'asyir. She advised the president not to stop at Ba'asyir in giving conditional release on humanitarian grounds. She refers to a number of cases, which, according to her, also need to be given humanitarian considerations. Other cases that need to be considered include the case of the Baiq Nuril, Meiliana, until the waiting list for capital punishment with a waiting period of up to 10 years (Dwiastono, 2019).

President Jokowi's decision on this parole is based on Regulation of the Minister of Law and Human Rights number 3 of 2018 and not based on presidential clemency. In the ministerial regulation, there are several special conditions that must be met by terrorist prisoners to get parole. In addition to having undergone 2/3 of the detention periods, inmates must be willing to work together to dismantle the case that they did, show remorse for their mistakes, and written statements regarding loyalty to the NKRI. The problem is that Ba'asyir does not want to agree to the terms proposed by the

government, which must be loyal to the Pancasila and the NKRI, as one of the conditions for his release.

This presidential decree has become a polemic for the nation and the world. Not only the people of Indonesia, but the world is indeed being intensified with the problem of terrorism and Islamophobia. The author takes the rules on terrorism and human rights in the United Nations in Article 3 of the Universal Declaration of Human Rights stating, "Everyone has the right to life, freedom, and safety as individuals." There was also an International Covenant on Civil and Political Rights which was accepted by the UN General Assembly on December 16, 1966. The contents of the agreement relating to the violation of human rights caused by acts of terrorism were the right to life, and the death penalty only for serious crimes.

This is the difference between the human rights-based and human rights-based approach to eradicating terrorism. We have witnessed the adoption of the Patriot Act in the United States, which has been implemented since the terror of the WTC Twin Towers in New York on September 11, 2001 (Hartono, 2017). Through the law, US officials can interrogate, arrest, and detain someone who is accused of being a terrorist arbitrarily and with unlimited time.

After 16 years, the United States declared war on terror; terrorism even expanded from the Middle East to Southeast Asia. While in Indonesia, suspected terror is treated as a human being with inherent rights protected by law. Those accused of terrorism are tried through a legal process by prioritizing the principle of due process of law in the corridor of the criminal justice system. With a human rights-based approach, terrorism can be localized so that it does not spread to the public. A humanist approach to place terrorists in the field is not only as perpetrators but also victims. They are victims of indoctrination and the spread of false religious understandings through various media, including the internet.

For this reason, after being imprisoned, they must be rehabilitated and empowered socially and economically. The Human Rights approach also provides a significant portion to non-state actors (community organizations, media, educational institutions, NGOs, etc.) to play a role in combating terrorism. This is because terrorism, as a notion and movement, cannot only be overcome by state officials whose numbers and capacities are minimal, compared to the scale of threats and terror movements that are very broad and globalized.

Through examinations in court, state officials can obtain a lot of data and information about terrorism obtained from suspects/defendants, witnesses, experts, and other evidence. This information is useful for uncovering and tracing the terror network that is in the interest of prevention and prosecution. In addition, the law enforcement process is a public education media and suspected terrorists that what they do is wrong and violates the law. Community participation is significant social capital so that counterterrorism becomes a social movement; not only is it the duty and responsibility of state apparatus, which in many cases has many limitations.

C. *The Making of Public Policy Formulation in The Disruptive Era*

Disruption clearly has a double eye, besides the positive contribution to needs, there are also negative impacts, on the other hand, the people who are ready with all the prerequisites certainly receive abundant benefits, but for the less fortunate

it is clearly woeful even though the business sector is depressed. Moreover, the governments of both the executive and legislative bodies are in response. Society can be harmed dozens of times if the government is not sensitive to change; the government should not leave any party in development. Even though in Indonesia itself, the government has indeed been labeled as slow, when it has been disrupted, it has just been rushed to produce late regulations.

The Ba'asyir Liberation Case and the music bill have become an example of public policy implemented when the problem has taken place, and the world has far left. For example, Ba'asyir, according to the author, the president's decision on this matter is not wrong because the president also emphasizes the human rights that Ba'asyir has. Besides terrorists and victims, both of them have their own human rights, just like the case of Basuki Cahya Purnama (AHOK) when he was convicted of blasphemy. The author also has human rights to speak; the author assumes that religion and politics are not easy to mix up. Not because the author is not religious and realist, but the author understands the importance of religious rights and rights to opinion.

As with the music bill. If the Ba'asyir case still has a legal umbrella to consider, then what will happen to the Indonesian music industry? This bill is already in the 2019 national legislation program, and the actors who carry out this Act do not necessarily approve. The author realizes the lack of awareness of the Indonesian people towards "respecting the work of others." The author agrees to the right to freedom of creation and the presence of the Bekraf to free the millennials to work and be creative. The author also agrees to the existence of Copyright Law, Electronic Information and Transaction Law, and all laws relating to the legitimacy of Indonesia's great creators' rights. In this case, the author agrees with the government to improve existing laws so as not to overlap with other laws.

In today's disruptive era, public policy must be as effective as possible, which is indicated by indicators: more straightforward, cheaper, accessible, dan faster. The process of policy formulation can be carried out through the following seven stages; they are:

a) *Assessment of the Problem.* The aim is to find and understand the nature of the problem from a problem and then form it in a causal relationship.

b) *Determination of Goals.* Is the stage to determine the objectives to be achieved through a public policy which will soon be formulated.

c) *Alternative Formulation.* Alternatives are a number of problem-solving solutions that might be applied to achieve a predetermined goal.

d) *Modeling.* The model is a simplification, and the reality of the problems faced is manifested in a causal relationship.

e) *Determination of criteria.* Policy analysis requires clear and consistent criteria to assess alternative policies offered. Criteria that can be used include economic, legal, political, technical, administrative, community participation, and others.

f) *Alternative Assessment.* Alternative assessment is performed by using criteria in order to get a further picture of

the level of effectiveness and feasibility of each alternative in achieving goals.

g) *Formulation of Recommendations.*

Recommendations are prepared based on the results of alternative policy assessments that are expected to be able to achieve the objectives optimally and with the least possible impact.

Of the two cases, the author took the point for each policy taken. If this policy is made based on realizing the interest of the public, then the public should agree on both cases. The author's attention is put on how many people whose interests are being fought for. And which political interests actually make this decision.

V. CONCLUSION

The policy exists to put the industry or the community within their framework, so they adhere with according to the prevailing conditions. However, the policy framework that fits this era should not be rigid. Policies must be more flexible and adaptive in responding and anticipating circumstances. It means that in the future an adaptive public policy is needed, able to adjust to changes. Ideally, public policies that are compatible with the change, no longer need to regulate matters that are detailed and technical. In that dimension, individual creativity becomes the foundation, industry associations, and community rules that play an essential role. As government officials, they must understand more about each character. Policies become increasingly flexible even though they still have to be preventive and anticipatory. Abundant data sources and technological sophistication should make policymakers faster and more accurate in issuing policies. This condition can occur if giant data sources (big data) are well managed and integrated.

REFERENCES

- [1] (2019, Februari). Retrieved from Koalisi Nasional Tolak RUU Permusikan: <https://tolakruupermusikan.com/kntl-ruup/>
- [2] Ade Ridwan, Vindry, dan M Taufiq. (2019, Januari 20). *Pembebasan Abu Bakar Ba'asyir, Politik atau Kemanusiaan?* Retrieved from Tempo.co: <https://fokus.tempo.co/read/1166845/pembebasan-abu-bakar-baasyir-politik-atau-kemanusiaan/full&view=ok>
- [3] Agustino, L. (2008). *Dasar-dasar Kebijakan Publik*. Bandung: Alfabeta.
- [4] Baderi, F. (2017, November 21). *Kebijakan di Era Disruptif*. Retrieved from Harian Ekonomi Neraca: <http://www.neraca.co.id/article/93264/kebijakan-di-era-disruptif>
- [5] Cahyono, E. (2017, Oktober 11). *Era Disruption dan Manajemen Strategik Birokrasi*. Retrieved from Sekretariat Kabinet Republik Indonesia: <https://setkab.go.id/era-disruption-dan-manajemen-strategik-birokrasi/>
- [6] Cahyono, E. (2018, March 27). *Revolusi Industri 4.0 dan Transformasi Organisasi Pemerintah*. Retrieved from Sekretariat Kabinet Republik Indonesia: <https://setkab.go.id/revolusi-industri-4-0-dan-transformasi-organisasi-pemerintah/>
- [7] Dunn, W. N. (2000). *Pengantar Analisa Kebijakan Publik*. Yogyakarta: Gajah Mada Press.
- [8] Dwiastono, R. (2019, Januari 21). *Mekanisme hingga alasan pembebasan Abu Bakar Ba'asyir dipertanyakan*. Retrieved from BBC News Indonesia: <https://www.bbc.com/indonesia/indonesia-46937135>
- [9] Eriyanto. (2018). *Disrupsi*. Jurnal Komunikasi Indonesia, ii.
- [10] H.A.R Tilaar & Riant Nugroho. (2012). *Kebijakan Pendidikan; Pengantar untuk Memahami Kebijakan Pendidikan dan Kebijakan Pendidikan sebagai Kebijakan Publik*. Yogyakarta: Pustaka Pelajar.
- [11] Halim, D. (2019, Januari 21). *Pakar Hukum: Pembebasan Abu Bakar Ba'asyir Tak Berlandaskan Hukum*. Retrieved from Kompas.com: <https://nasional.kompas.com/read/2019/01/21/12263221/pakar-hukum-pembebasan-abu-bakar-baasyir-tak-berlandaskan-hukum>
- [12] Hartono, M. D. (2017, July 11). *Mengapa HAM Penting dalam Penanggulangan Terorisme?* Retrieved from Kompas.com: <https://nasional.kompas.com/read/2017/07/11/21084441/mengapa.ham.penting.dalam.penanggulangan.terorisme>
- [13] Irfani, F. (2019, February 4). *RUU Permusikan Menuai Protes, Apa Isi Aturan Musik di Negara Lain?* Retrieved from tirto.id: <https://tirto.id/ruu-permusikan-menuai-protes-apa-isi-aturan-musik-di-negara-lain-dfPJ>
- [14] M Imaduddin, Azis Husaini. (2019, February 10). *Bekraf: Optimalisasi pungutan royalti bagi pemusik jadi urgensi saat ini*. Retrieved from Kontan.co.id: <https://nasional.kontan.co.id/news/bekraf-optimalisasi-pungutan-royalti-bagi-pemusik-jadi-urgensi-saat-ini>
- [15] Michael Howlett and Ramesh. (1995). *Studying Public Policy: Policy Cycles and Policy Subsystem*. Toronto: Oxford University Press.
- [16] Mustopadidjaja, A. (2002). *Manajemen Proses Kebijakan Publik, Formulasi, Implementasi dan Evaluasi Kinerja*. Jakarta: LAN.
- [17] Pambagio, A. (2018, September 17). *Dilema Gagalnya Mengatur Transportasi Daring*. Retrieved from detik News: <https://news.detik.com/kolom/d-4215301/dilema-gagalnya-mengatur-transportasi-daring>
- [18] Prabowo, H. (2019, Februari, 8). *RUU Permusikan: Kesalahan Ada pada Badan Keahlian DPR RI*. Retrieved from Tirto.id: <https://tirto.id/ruu-permusikan-kesalahan-ada-pada-badan-keahlian-dpr-ri-dgir>
- [19] Roger C. Brackin, Michael J. Jackson, Andrew Leyshon and Jeremy G. Morley. (2019). *Taming Disruption? Pervasive Data Analytics, Uncertainty, and Policy Intervention in Disruptive Technology and its Geographic Spread*. *International Journal Of Geo-Information*, 8(34).
- [20] Roja, W. (2018, Juni 5). *Disruption dan Pengaruhnya bagi Ilmu Pengetahuan*. Retrieved from Kompasiana : <https://www.kompasiana.com/wiliamsroja/5b16a0fcab12ae2c0b2b33c2/disruption-sebagai-gangguan-dan-inovasi-serta-pengaruhnya-bagi-perkembangan-ilmu-pengetahuan?page=all>
- [21] Sindo, K. (2018, January 3). *Tahun Disrupsi*. Retrieved from Sindo News: <https://nasional.sindonews.com/read/1270526/16/tahun-disrupsi-1514924911>
- [22] Widyatama, B. (2015, June 24). *Konsep dan Teori Kebijakan Publik*. Retrieved from Kompasiana: <https://www.kompasiana.com/bastianwidyatama/552c58856ea8345e6e8b4568/konsep-dan-teori-kebijakan-publik>
- [23] *Government Policy in Realizing Basic Education Metro*. <https://www.ijitee.org/wp-content/uploads/papers/v8i9S3/I30230789S319.pdf>
- [24] *Indonesia's President Widodo Agrees with the Liberation of Ba ...* <https://theinsiderstories.com/president-widodo-agrees-the-liberation-of-terrorism-baasyir/>
- [25] *Policy Implementation of City Park Utilization in Malang ...* <https://www.neliti.com/id/publications/259902/policy-implementation-of-city-park-utilization-in-malang-city>
- [26] *Indonesia's President Widodo Agrees the Liberation of Ba ...* <https://theinsiderstories.com/president-widodo-agrees-the-liberation-of-terrorism-baasyir/>

- [27] Ba'asyir's sons, followers disappointed over canceled
<https://www.thejakartapost.com/news/2019/01/23/baasyirs-sons-followers-disappointed-over-canceled-release.html>
- [28] Indonesia's President Widodo Agrees the Liberation of Ba
<https://theinsiderstories.com/president-widodo-agrees-the-liberation-of-terrorism-baasyir/>

LIST OF FIGURES

- i. Figure 1. Christensen's Model of Disruptive Innovation in Roger C. Brackin, Michael J. Jackson, Andrew Leyshon and Jeremy G. Morley, 2019
- ii. Figure 2. Cycle of Process of a policy according to Thomas R. Dye in Dunn.

Millennial's ASN: Disruptor of Bureaucracy Towards Humanocracy and Becoming Digitocracy

Herie Saksono

*Research & Development Agency of the Ministry of Home Affairs
Ministry of Home Affairs, Indonesia
herie.saksono26@gmail.com*

Abstract - The existence of the millennial generation in the digital era today has disrupted various things. Millennials have changed everything's. Millennials have penetrated the public sector, formed new work patterns, managed digital-based activities, and optimize digital media channels as a means of communication, work processions, and publicizing their performance. Government bureaucracy is increasingly dominated by millennial civil servants (ASN). Will its existence disrupt the bureaucracy, turn it into a humanocracy or directly adapt it as a digitocracy? This study aims to describe the existence of millennials ASN and its work in the government bureaucracy. The method used is descriptive-qualitative. Data analysis through stages of data reduction, data presentation, and conclusion/verification. Studies show that the existence of massively millennial's ASN in government organizations will disrupt bureaucracy by reforming management and work patterns becoming more human and digitally based. This situation created a humanocrats who shifted the role of bureaucrats and even adapted it to become a digitocrats. The study concluded that the development of digital technology would shift the working pattern of millennial's ASN to be more humanistic through utilization of digital devices. It is recommended that the Government should facilitate the transformation of bureaucracies and formulate adaptation strategies into digitocracy.

Keywords: Millennial ASN, Disruption, Bureaucracy, Humanocracy, and Digitocracy.

Introduction

Research Background

At present, we unwittingly experience drastic changes that occur suddenly, streaky, and massive. The change was the transition of generation from Generation X which transformed into Generation Y (millennial generation) and along with it also followed a shift in work patterns and lifestyle from manual / conventional to digital processes. The accumulation of both has implications for changes in the life order according to the demands of the generation of his era. This phenomenon is a disruption that penetrates various sectors and all aspects of human life. Millennials are characterized by various demands that need to be fulfilled quickly and even instant with quality results.

Uniquely, the millennial generation grew along with the rapid development of digital-based information technology, so they lived in the digital era. The digital age is believed to be able to

increase efficiency, bring distance closer, simplify work and provide higher quality work results.

Digital services in question are the administration of government both at the central and regional levels that are digitally based and carried out by all state civil apparatus (ASN). The meaning is that all government activities and transactions are carried out massively and are digitally based.

The existence of the millennial generation in the digital era today has disrupted various things. Along with technological advancements and digitalization, people have increasingly high quality service demands, so bureaucracies that are able to develop digital service oriented strategies are needed.

Millennials changed everything because they had the ability to adapt quickly to the Industrial Revolution 4.0, where digital technology became the main driving force and was held massively. Simultaneously, the millennial generation and digital technology have penetrated the public sector. The competency of millennial ASN also influences the formation of work patterns and management of activities that are compulsory based on digital. The presence of millennial ASN which is able to optimize digital media channels as a means of communication, work procession, and publish its performance is very dependent on the availability of digital technology in its work environment.

Will its existence disrupt the bureaucracy, turn it into a humanocracy or instead directly adapt it as a digitocracy?

Purpose

This study aims to describe the existence of millennial ASN, the dynamics of the pattern of ASN work in the digital era, and its work in the administration of government.

Research Benefit from Theoretical and Practical

Theoretically, through this study it is expected that it can be proven that there has been a disruption of bureaucracy and personnel management in the public sector. Major changes as a result of digitalization have actually transformed the bureaucracy into a digitocracy. This phase of change demands comprehensive, holistic learning so that state civil society and the public can interpret it correctly and actualize it appropriately. Practically, a more humane approach is needed, according to the needs of public services, supporting good governance, being able to respond to global changes, and in time to realize a better Indonesia.

Literature Review

The term disruption has long been introduced by Clay Christensen (1997). Oey-Gardiner, et al. (2017: 2) in his study states that disruption is a very basic change as has happened in various industries. Today the term disruption has become the topic of conversation. The term disruption comes from the word disrupt = confusing; disturb. Disruption = disorder; chaos. Disruptive = which is disruptive; disturbing (Muliawaty; 2019: 7). In his study, Muliawaty (2019: 8) at the same time concluded that the disruption era was an opportunity and a challenge to modern human resource management practices. The opportunity is to improve the performance of leaders and employee readiness as human resources towards the best performance, improve an organization/organization to be more efficient, effective, and competitive.

In an effort to realize national goals, professional employees are needed to manage the government. Guided by the provisions of Article 1 Number 1 of Law (Law) Number 5 of 2014 concerning State Civil Apparatus stated that the State Civil Apparatus (ASN) is a profession for civil servants (PNS) and government employees with work agreements (PPPK) working on government agencies. In the explanation of the Law, it was explained that ASN employees were assigned the task of carrying out public service tasks, government duties, and certain development tasks. The task of public service is to provide services for goods, services, and / or administrative services provided by ASN employees. The task of government is carried out in the context of the implementation of general government functions which include institutional, personnel, and management utilization. In the context of implementing certain development tasks carried out through nation-building (cultural and political development) as well as through economic and social development (economic and social development) which is directed at increasing the welfare and prosperity of the entire community.

In his book, Howe and Strauss (2000: 20,36) became the first originators of the term millennials. He stated that the generation born between 1981-1998 did not include Generation X and also not part of Generation Y, they were Millennials (Not X, Not Y - Call Them Millennials). In addition, Berkup (2014: 219) uses the chronology classification of the Generation of Baby Boomers for those born between 1946-1964, Generation X for those born between 1965-1979, Generation Y for those born between 1980-1994, and Generation Z for those born between 1995-2010. The Y generation is better known as the Millennial Generation.

There are still many opinions in determining age groups per generation. However, the classification of generation chronology specifically used for ASN in this study is:

- a. Generation of Baby Boomers (BB): born before and until 1960;
- b. Generation X (Gen Xers): born between 1961-1980;
- c. Generation Y (Gen Millennial): born between 1981-1994; and
- d. Generation Z (Gen Z): born between 1995-2010.

In this study, bureaucracy is an instrument / apparatus that has the task and function of regulating, managing, and carrying out governance both at the central and regional levels. While the importance of rationality in the bureaucracy is not negated, so as not to degenerate into bureaus, Golandaz (2005: 206-207) recommends introducing organizational components that recognize humanity in society. Such components can be referred to as humanocracy. Thus, the aim is not to replace the bureaucracy with humanity but to make these two elements coexist in an organization and function to complement each other. In short, humanocracy allows organizations to understand their social obligations and fulfill the same thing when they achieve their other goals, especially economics. In order not to be misunderstood, the same applies to the government, where they provide the same interests to their ministries / departments / non-economic functions, if not more.

According to Golandaz (2005: 208-211) humanocracy can be introduced in organizations through nine principles, namely: i) principle of human scale; ii) principle of human need satisfaction; iii) principle of participation; iv) principle of functional generalization and vertical integration; v) principle of authority of merit and leadership turnover; vi) principle of primary communication; vii) principle of design psychology; viii) principle of subjectivity and its corollaries; and ix) principle of simplification.

Along with the transformation of civilization in the digital era, Reidenberg (2017; 26) states that the digital era, calling for the emergence of Digitocracy - a set of more complex governance mechanisms that guarantee public accountability for online power held by state and non-state actors through the creation of checks and new balance among groups of players that are more diverse than traditional democratic groupings from legislative representatives, the executive branch, and the judiciary.

Research Methodology

This study is part of the research on the performance of regional government administration. Research uses a qualitative approach. Data and facts are analyzed through stages of data reduction, data presentation, and conclusion / verification. Then the results are interpreted descriptively.

Results & Analysis

The government bureaucracy is increasingly dominated by the state civil apparatus (ASN) originating from millennials. Studies show that the existence of massive millennial ASNs in government organizations will disrupt bureaucracy by reforming management and working patterns becoming more human and digital based. This situation is supported by the development of digital technology that has penetrated various lines of work.

In the perspective of government management in the digital era, ASNs in government institutions and regional governments have become very helpful in carrying out their domestic government affairs. Because, all the bureaucratic

activities that must be carried out by ASN are transformed into a digitalization process. Digital technology brings a variety of conveniences and can simplify complicated work procedures, so that it becomes more practical, easy to do, and measurable results. The implication is that the performance of the ASN increases because all the work carried out can be controlled and observed from various different places. The procedures and workings of the ASN undergo fundamental improvements and changes. Slowly ASN abandoned the conventional way of working that based each of its activities manually and switched to using digital technology. Therefore, the digitization process is no stranger to millennial ASNs.

The advancement of digital technology which greatly helped organize government activities also forced the ASN from Generation X and Generation of Baby Boomers to adjust and study it carefully. However, the relatively larger number of predecessor generations is certainly not able to give a significant influence. The number of government employees and regional governments according to their generation is presented in Table 1 below.

Table 1. Numbers of Civil Servant of State and Regional Government Based on Generation in 2019

Government	Numbers and Percentages per ages *)				Total
	BB (%)	Gen X (%)	Gen Y/ Millennial (%)	Gen Z (%)	
State	32.341 (3,35)	617.148 (63,97)	274.864 (28,49)	40.331 (4,18)	964.684
Regional	155.580 (4,66)	2.364.506 (70,75)	802.379 (24,01)	19.605 (0,59)	3.342.070
Total	187.921 (4,36)	2.981.654 (69,23)	1.077.243 (25,01)	59.936 (1,39)	4.306.754

Source: Directorate of System Information Development, Deputy Office of Information System of Human Resource, the Board of National Human Resource, 2019.

*) Baby Boomer (BB): Born before and until 1960
 Generation X (Gen X): Born in 1961-1980
 Generation Y (Gen Millennials): Born 1981-1994
 Generation Z (Gen Z): Born 1995-2010

Based on its generation, the data in Table 1 prove the occurrence of regeneration at the ASN level both at the center and within the local government. Even though there is still a dominance of Generation X which reaches 69.23% of all ASNs, until the beginning of 2019 there are 25.01% millennial ASNs working in the government sector.

The digital age is synonymous with speed and quality. The dynamics of change in the digital era are often not overtaken and are followed by conventional manual work patterns. This gives the impression that ASNs are often late responding through the regulatory / policy needs needed to regulate, manage, and utilize changes that occur in the interest of public services. This lag is a necessity when regulative functions dominate governance rather than facilitative functions.

The generation shift accompanied technological progress. This also affects the organizational culture and the workers. Bureaucracy changes to humanity as a synergy of organization, management, facilities, and human resources that manage the organization. This shift is illustrated in Figure 1.

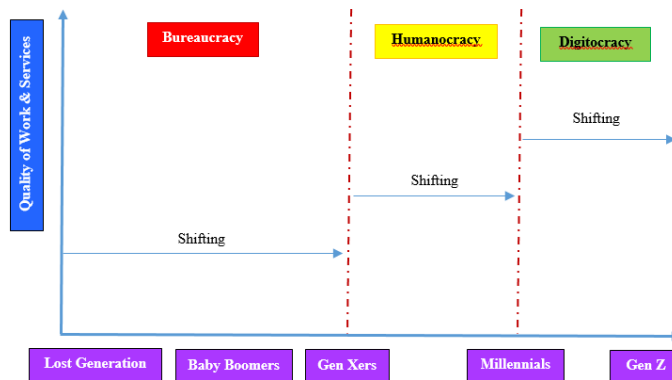

Figure 1. Transition Process of Bureaucracy Became Humanocracy and Digitocracy

Looking at Figure 1, along with the process of transferring generations, the bureaucracy also undergoes transformation into a humanocracy. The strengthening of the use of digital technology has changed the working pattern of millennials based on digital technology. This situation forms the characteristics of bureaucracy, humanity, and digitocracy with various characteristics as presented in Table 2.

Table 2. Characteristic of Bureaucracy, Humanocracy, & Digitocracy

No.	Aspect	Distinction and Characteristic		
		Bureaucracy	Humanocracy	Digitocracy
1.	Instrument / Main Actor	Bureaucrate	Humanocrate	Digitocrate
2.	Position	Structural	-	-
3.	Mechanism of Work	Bureaucracy	Humanocracy	Digitocracy
4.	Main working infrastructure	Manual supporting infrastructure, tools, and facilities,	Automatic supporting infrastructure, tools, and facilities,	Digital technology
5.	Working Hour	According to Office Hour)	Semi Flexible	Flexible
6.	Working Place	Office Building	Office Building & Co-working Space	Co-working Space
7.	Basis of Work	Bureaucracy	Humanocracy	Digitocracy
8.	Quality of Work	Prima	Prima, Ultima, & Optima	Fast, Prima, Ultima, & Optima
9.	Management of Work	Closed-tendency	Semi-open	Transparent, Accountable, & Innovative
10.	Output	Performance	Performance & Humane	Performance & Service that is more humane

The digital age encourages the entire ASN to be a leader and not a follower of the use of digital technology in the government field. The government must enable the entire ASN to take advantage of the development of digital technology. Because, digitalization has penetrated all the lives of the entire community including the ASN and its government bureaucracy.

Digital technology becomes an urgency in the implementation of domestic governance (including regional government). It can also be predicted that government management will experience a setback when it ignores the progress of digital technology and human capital that manages it. Digital technology plays a strategic role in the formulation of evidence-based policies along with the industrial revolution 4.0. This situation gave rise to the humanitarian who shifted the role of bureaucrats and even adapted it to become a digitocrat.

Conclusion & Recommendation

The development of digital technology shifts mindset, attitude patterns, and patterns of action, thus forming a millennial ASN culture culture that is more humanistic and prioritizes the use of digital technology in public service delivery. The implementation of digital-based governance changes the order of central government organizations and regions to be more humane with smaller sizes.

In carrying out its work, millennial ASNs are more focused, productive, and performing when they have the opportunity to utilize digital devices and channels optimally in carrying out their duties and functions. Optimizing digital platforms in governance and providing public services will disrupt bureaucracy, which in general still works with a pattern of routines, based on manuals, and uses conventional methods.

Millennial ASN has revolutionized the pattern of government work to be digital based and disrupting bureaucracy to become a digitocracy.

IT IS RECOMMENDED THAT THE GOVERNMENT FACILITATE THE TRANSFORMATION OF BUREAUCRACIES AND FORMULATE ADAPTATION STRATEGIES INTO DIGITOCRACY. THE GOVERNMENT IS ASKED TO COMMIT AND HAVE THE OBLIGATION TO PREPARE VARIOUS INFRASTRUCTURES IN AN EFFORT TO SUPPORT THE IMPLEMENTATION OF GOVERNMENT PROGRAMS / ACTIVITIES AND THE IMPLEMENTATION OF DIGITAL-BASED PUBLIC SERVICES.

REFERENCES

- Howe, Neil., and William Strauss. (2000). *Millennials Rising: The Next Great Generation*. Vintage eBooks. Publisher: Random House USA Inc. Imprint: Vintage Books. New York. United States.
- Oey-Gardiner, Mayling., Susanto Imam Rahayu, Muhammad Amin Abdullah, Sofian Effendi, Yudi Darma, Teguh Dartanto, dan Cyti Daniela Aruan. (2017). Era Disrupsi: Peluang dan Tantangan Pendidikan Tinggi Indonesia. Cetakan II. Akademi Ilmu Pengetahuan Indonesia. Penerbit Akademi Ilmu Pengetahuan Indonesia (AIP). Jakarta.
- Berkup, Sezin Baysal. (2014). Working With Generations X And Y In Generation Z Period: Management Of Different Generations In Business Life. *Mediterranean Journal of Social Sciences*, MCSER Publishing, Rome-Italy, 5(19), August, 218-229.
- Golandaz, Hafiza. (2005). From Bureaucracy To Humanocracy: Role of Leadership. *Indian Journal of Public Administration*, 51(2), April-June, 199-215.
- Mileski, Joan P., & Carter L. Franklin. (2017). The Humanization of Corporations. *American Journal of Management*, 17(3), 29-37.
- Muliawaty, Lia. (2019). Peluang dan Tantangan Sumber Daya Manusia Di Era Disrupsi. Kebijakan. *Jurnal Ilmu Administrasi*. Vol. 10. No. 1. Januari 2019. Hal. 1-9.
- Reidenberg, Joel R. (2017, September). Digitocracy. *Communications of the ACM*. Volume 60 Issue 9, September 2017. Pages 26-28. New York, NY, USA. doi>[10.1145/3126489](https://doi.org/10.1145/3126489).
<https://cacm.acm.org/magazines/2017/9/220437-digitocracy/abstract>

Mental Health: Strategies to Reduce *Pasung* Cases in East Java

1st Lutfia Nurul Hidayati
Public Policy
Airlangga University
Surabaya, Indonesia
lutfifilut@gmail.com

2nd Erna Setijaningrum
Public Policy
Airlangga University
Surabaya, Indonesia
erna.setijaningrum@fisip.unair.ac.id

3rd Antun Mardiyanta
Public Policy
Airlangga University
Surabaya, Indonesia
antun.mardiyanta@fisip.unair.ac.id

4th Susi Hardjati
Public Administration
UPN Veteran Jawa Timur
Surabaya, Indonesia
susihardjati@gmail.com

Abstract—East Java Province ranks first in the number of the shackling cases of patients with psychiatric disorders or can be called psychotic. The Ministry of Social Affairs recorded that there were 1,200 people were shackled (*pasung*) in 2016. As many as 459 people were freed from *pasung* out of the total of 741 people. There were mental illness sufferers in East Java who were scattered in 38 regencies / cities. Then in 2017 there were 757 cases and until 2018 there were 888 cases. Thus, government seeks to reduce cases of the shackling of people with mental disorders through *E-pasung* and Sub-District Social Welfare Workers' assistance. The purpose of this research is to find out strategies in reducing the number of *pasung*-free cases in East Java. This research uses a qualitative research methodology. Data collection techniques were conducted by interviewing Social Services and Health Services. To strengthen the argument, the studies of documentation and literature were also used in this research. The results of this study indicated that the innovation of public services in the form of *E-pasung* initially declined but in the following year it increased to 2018. The Social Service also involved 110 *pasung* assistants, including the ones from the TSKS (Sub-District Social Welfare Workers). Assistance to family of the shackled people in terms of monitoring the availability of drugs, family education to take patients to hospitals and to rehabilitation centers.

Keywords—*Pasung-Free Program in East Jawa*

I. INTRODUCTION

Bad stigma still envelops mental health issues in Indonesia. The myths of mental disorders in most regions in Indonesia believe in the causes of mental health disorders such as demon possession, sinners, immoral acts and lack of faith. So that instead of getting a medical handler, somebody with mental disorder was taken to a spiritual expert. This stigma encourages discriminatory actions. The role of the family is very important to recognize family problems related to mental disorders. Family is the first place to meet one's basic needs. Referring to Maslow's hierarchy that mental health is a basic need for self-actualization. Family social support capacity is an integral part of social support, any family related matters have the impact of social mobilization and may help individuals to overcome problems during periods of crisis, help the health conditions of family members, while improving the well-being of all family members [1].

Pinel became a pioneer in releasing patients who were put up in several mental hospitals and disagreed with such practice [2]. In Indonesia, such restraining methods include: shackles, ropes, wooden frames, cages, and locking people in confined spaces [3]. These methods are applied to men, women, and children who show certain attitudes, behaviors and emotional expressions that are different from most people [4]. The basic differences that need to be identified to mark confinement or restraint and seclusion are: restraint and seclusion are actions taken by authorized medical authorities whereas confinement is carried out by non-professionals and non-practitioners, for example by family and society [5].

In 2018, basic health research noted that the prevalence of severe mental disorders in Indonesian population was 1.7 per mile. East Java Province in 2016 became one of the highest provinces with 1,200 cases of shackling. In 2017 there were 757 cases and in 2018 there were 888 cases. Patients with psychiatric disorders or can be called psychotic are influenced by various biological, psychological and social diversity of the population. The number of cases of mental disorders is likely to continue to grow. Factors that trigger schizophrenia can be influenced by emotional turbulent families, stressful life events, discrimination, and poverty. An unstable emotional environment can also be considered to have a great risk for the development of schizophrenia [6].

Law Number 18 of 2014 on Mental Health is intended to ensure that everyone can achieve a good quality of life, as well as providing integrated, comprehensive and sustainable health services through promotive, preventive, curative, and rehabilitative efforts. Broadly speaking, the Law mandates: 1) the need for community participation in protecting and empowering People with Mental Disorder (ODGJ) with more assistances in the form of: personnel, funds, facilities, treatments for ODGJ; 2) Provide protection against violence, create a conducive environment, provide skills training; and 3) oversee the provision of the services provided in the facilities serving ODGJ [7]. Furthermore, East Java governor's decision number 188/125/kpts/2019 on Community Mental Health Steering Team.

East Java Provincial Social Service is working together with East Java Provincial Health Office in reducing the number of pasung cases through E-pasung and official assistance. This year the provincial government also educated patients' families by sending 145 pasung companions spread across 38 districts / cities, adjusted with the number of pasung sufferers. With one companion for 15-16 pasung patients.

The study of public administration has experienced a paradigm shift from government to governance, where within this governance paradigm does not only involve one sector. Institutions of the governance paradigm include 3 elements, which are state, private and society sectors [8]. The 3 sectors of governance can participate in the administration of public administration according to their respective roles. It means that the community as a society sector can participate in the settlement of public issues that cannot be solved by individuals or private and state sectors [9].

Based on this background, a research on strategies to reduce pasung-free cases in East Java needs to be done. The purpose of this study was to determine the evaluation of E-pasung service innovation and assistance in reducing pasung-free cases in East Java. The results of this study will hopefully be able to provide theoretical development in the realm of public policy services, related to the case of shackling in East Java and able to provide recommendations and map out problems that become obstacles in reducing cases of shackling in East Java.

II. METHODOLOGY

This research uses a qualitative research methodology. The characteristics of qualitative research are (a) qualitative research has a natural setting as a source of research and researchers are the key instruments; (b) qualitative research data are descriptive. Data are collected in the form of images, not numbers; (c) qualitative research has something to do with processes rather than simply with products or results; and (d) a qualitative approach is more concerned with "meaning". 4 informants in this study were taken from Social Service and Health Service. Strategy to reduce cases of eradication through E-pasung and assistance spread across 38 districts / cities [10]. Data analysis includes three steps namely data reduction, data presentation and drawing conclusions [11].

III. RESULTS & ANALYSIS

Some health problems need special attention so as not to burden Indonesia in time to come. These health problems include maternal and child health, tuberculosis, non-communicable diseases, mental health and head injuries due to health [12]. The findings of Riskesdas in 2018 reveal that total number of people with mental health jumped from 1.7% in 2013 to 7%. As a result, what people can do to people with severe mental disorders is shackling. The practices of shackling were scattered in various provinces in Indonesia. The highest number of shackling (pasung) cases from 38 provinces was found in East Java Province. In 2017 there were 143 cases

of pasung and the following year it increased to 754 cases of pasung. This is the concern of East Java Provincial Government in reducing pasung cases.

E-pasung is a service innovation program established by East Java Provincial Social Service and East Java Health Office in 2016 to reduce pasung cases in East Java. E-pasung is a collection of electronic data that can identify victims of complete shackling cases by name, by address, by photo and by assessment. The E-pasung public service innovation program can be accessed through <http://epasung.dinsos.jatimprov.go.id/>. The website contains the number of recapitulation data in East Java Province which is always updated by the coordinator of TKSK.

The purpose of the development of E-Pasung is to help stakeholders and the community to know the development of the Pasung cases. The community can also report if there are still cases of shackling in their areas of residence by notifying the TKSK assistants or to the nearest local Community Health Center (Puskesmas). Not all Puskesmas provides mental health services. Hospitals that provide mental health services are located in districts or provinces. Things like this make the victims' families reluctant to take them to a hospital that is a long distance away. There is also another effort to reduce pasung cases, i.e. by conducting public services as a form of participation, what is being done to complement and improve public services by 2 other government sectors.

E-pasung is a platform designed to make it easier for stakeholders and the public to know about data on the number of people being shackled (pasung). E-pasung tries to delve deeper in overcoming existing public problems by providing public services for victims of mental disorders. As community governance, the decision-making process is carried out by deliberation to obtain mutual agreement, and has a division of labor systems. In addition, E-pasung also acts as a means of exchanging information and knowledge that can be useful in achieving its goals. However, not all communities are able to implement community governance, only communities with adequate capacities can do it. Then how can E-pasung and TKSK assistance provide public services? This can be seen from the following points. There are 3 aspects studied in analyzing the capacity of community governance, namely human resources, organizational resources and social capital, and the capacity of E-pasung and assistance: E-pasung and TKSK assistance for human capital. The human capital of E-pasung is managed by TKSK coordinator while the assistants are spread out all over East Java in the amount of 145 social workers, under the auspices of East Java Provincial Social Service and East Java Provincial Health Service.

Community-Based Rehabilitation (RBM) is an effort to restore the functioning of people who experience disturbances or obstacles, both physically, mentally, psychologically, and socially, by relying on the role of family and community groups, and utilizing various initiatives, potentials, and community resources. The purpose of the RBM is to enable self-reliance in people with social welfare, family and community problems where they live. RBM is carried out through efforts to mobilize resources and potential of the

community, as well as situation of people with social problems, and through the best possible coordination with various related sectors in the framework of service integrity including referral services between sectors related.

In the case of pasung, there are 2 forms of social capital that can strongly be felt consisting of: first, social capital in form of bond between cadres and TKSK ceaselessly tries to build cohesiveness and trust of its members. This can be seen from the concern of East Java Provincial Social Service to social workers by holding a meeting once in every 3 months to provide reporting and skills training. Social capital that connects the two is the collaboration between Community, TKSK, Cadres and government.

Perceived from the dimension of community governance in running an organization, TKSK also receives support from public. Its support is in the form of public trust in TKSK, both from the general public and from families of ODGJ sufferers. The trust is formed on the basis of two things, namely the first, because basically they share similar identity with local people so they know each other and the second, because pasung-free program through E-pasung is supported by TKSK assistants who help the community to reduce cases of shackling in East Java Province. TKSK is also supported by its member management, i.e. by dividing the labor system at the sub-district and district levels. The division of labor systems is one form of organizational awareness, so that the division of labor system can facilitate the chair of the coordination to control and supervise its members.

Confinement or retention of schizophrenics, even if carried out by their families with the aim of security for themselves and those around them, is an act that is categorized as deprivation of the right to live properly, which means violating human rights. Things that can be done by his family for the achievement of a decent life for these mentally-disordered people is to make efforts to treat and care for them, i.e, placing them in in some health care facilities. Post-victim cares are provided through some community-based assistances. The companions must not be afraid of ODGJ victims, however, they still need to be careful in approaching schizophrenic patients. ODGJs are also human so they need to be treated humanistically (as a whole human being). Companions are also human so they need some strategies in approaching people with ODGJ and their families.

Of the total population of East Java 38,052,950, the total estimated health problems that occurred in East Java were 2,366,893 in 2019. Severe mental disorders amounted to 83,716 people, mental emotional disorders amounted to 2,283,177 people. Then there were 11,971 people who were put in jails. Many cases of ODGJ occur at the age of 35-44 years with a total of 1052 cases. Furthermore, at the age of 25-34 years the number was 805 cases. For ages not recorded was as many as 439 cases. The following is the number of severe ODGJ cases that are still being treated in East Java Province until January 2019.



Picture 2. Pasung Companion
Source: East Java Province Social Service, 2019

Table 1. Data for the discovery of cases of severe ODGJ with Shackling in East Java Province until January 2019

No.	Year	No. of Cases
1	December 2014	602
2	December 2015	608
3	December 2016	716
4	December 2017	757
5	December 2018	896
6	December 2019	662

Source: East Java Provincial Health Office 2019

People with schizophrenia can not recover completely but need regular treatment. However, some families assume that after being released from the pasung they have been declared cured, so that the medicine is not taken routinely any longer and when they relapsed the victims are being shackled again.

However, in E-pasung application and TKSK assistance as community management there are also problems such as medical staffs who have been trained by East Java Provincial Health Office suddenly being moved to another workplace, so that these vacancies have an impact on handling at the Puskesmas level. Pasung data collected in E-pasung web are only the latest updates and do not display regularly every year. As a result, the program has become ineffective and inefficient, making some members and public unaware of the projections of pasung cases each year. To deal with ODGJ victims, human resources with special abilities and skills are needed to provide guidance for ODGJ victims, which is characterized by an appropriate educational background. In addition, an increase in the skills of social workers is needed so that with such skills they will be able to develop more variations in training. Another problem deals with budgets: the private sector is not yet involved, so managers must encourage private sector to foster better mutual cooperation or propose to involve more CSR programs.

IV. CONCLUSIONS & RECOMMENDATIONS

From previous discussions, it can be concluded that community-based rehabilitation assistance has not been maximized, i.e. one TKSK accompanies 10 cases of ODGJ. E-pasung innovation also needs to be updated regularly so that the public is aware of the development of the strategy carried out by East Java Provincial Government in reducing the case of reducing pasung victims. Community can also participate in solving some public-related problems by conducting public services (community governance) to complement the

shortcomings of the two sectors. From previous discussions, it can be concluded that community-based rehabilitation assistance has not been maximized if as a matter of fact one TKSK accompanies 10 cases of ODGJ. E-pasung innovation also needs to be updated regularly so that the public becomes aware of the development of the strategies carried out by East Java Provincial Government in reducing the cases of pasung victims. Public can also participate in solving public-related problems by conducting public services (community governance) to complement the shortcomings of the other two sectors and public services, to be more effective. However, community governance requires some capabilities or capacities possessed by human resources of the organization, organizational resources should be generated to support the creation of the organization, and also, the need for collective action from various parties that may foster a wider network. In this case, it can be seen that it is necessary to maintain public trust so that it remains credible to do any tasks that may affect the sustainability of the organization.

ACKNOWLEDGEMENT

The authors are deeply indebted to Ms. Erna Setijaningrum, Mr. Antun Mardiyanta and Ms. Susi Hardjati for supporting the completion of this paper. The authors also wish to thank the editor for feedback provided by Muhammadiyah University of Yogyakarta, Indonesia.

REFERENCES

- [1] Kaakinen, J. R., Gedaly-Duff, V., Coehlo, D. P., & Hanson, S. M. H. H. (2010). *Family health care nursing: Theory, practice and research*. (ed. Ke-4). Philadelphia: F.A Davis Company.
- [2] Minas, H., & Diatri, H. 2008. Pasung: physical restraint and confinement of the mentally ill in the community. *International Journal of Mental Health System*, 2, 1-8 doi:10.1186/1752-4458-2-8.
- [3] Irmansyah, I., Prasetyo, Y.A., & Minas, H. (2009). Human rights of persons with mental illness in Indonesia: More than legislation is needed. *International Journal of Mental Health Systems*, 3, 1-14, doi:10.1186/1752-4458-3-14
- Idaiani, S. & Raflizar. (2015). Faktor yang paling dominan terhadap pemasangan orang dengan gangguan jiwa di Indonesia. *Buletin Penelitian Sistem Kesehatan* 18, 11-17.
- [4] Lestari, W., & Wardhani, Y. F. (2014). Stigma dan penanganan penderita gangguan jiwa berat yang dipasung. *Buletin Penelitian Sistem Kesehatan*. 17(2), 157-166.
- [5] Malfasari, E., Keliat, B. A., & Daulima, N. H. C. (2014). Analisis legal aspek dan kebijakan restrain, seklusidan pasung pada pasiende gangguan jiwa. *Proceeding Konferensi Nasional XI Keperawatan Kesehatan Jiwa 2014*. 352-371.
- [6] Hermiati D, Harahap RM. 2018. Faktor Yang Berhubungan dengan Kasus Skizofrenia pada Pasien Rawat Inap RSKJ Soeprato Provinsi Bengkulu.
- [7] Undang-Undang Nomor 18 tahun 2014 tentang Kesehatan Jiwa
- [8] Syafri W 2012 *Studitentang Administrasi Publik* (Jakarta :Erlangga) p 177.
- [9] Bowles S and Gintis H 2001 *Social Capital and Community Governance Economic Journal*
- [10] Bogdan, R.C., Biklen, S.K. (1982). *Qualitative Research For Education: An Introduction to Theory and Method*. Boston :Allyn and Bacon, Inc.
- [11] Miles, B. Mathew dan Michael Huberman. (1992). *Analisis Data Kualitatif* Buku Sumber Tentang Metode-metode Baru. Jakarta: UIP.
- [12] WHO. 2018. Schizophrenia. <http://www.who.int/mediacentre/factsheets/fs397/en/> Diakses 15 Mei 2019.

Evaluation of Intangible Assets of Irrigation System in Malang Regency, East Java, Indonesia

Nugroho Tri Waskitho
Forestry Department

University of Muhammadiyah Malang
Malang, Indonesia
triwaskithon@yahoo.co.id

Jabal Tarik Ibrahim
Agribusiness Department

University of Muhammadiyah Malang
Malang, Indonesia
jabaltarik2003@gmail.com

Dyah Erni Widyastuti
Agribusiness Department

University of Muhammadiyah Malang
Malang, Indonesia
dyaherni@yahoo.com

Abstract—*The Irrigation system management has prioritized infrastructure aspects (tangible assets) in Indonesia. These include human resources, institutional and management receive less attention. This situation weakens the intangible assets, making them perform below the expectations. This study therefore was evaluated the intangible assets of irrigation system. It was conducted between May and July 2018 in the Water Resources Public Works Office of Malang Regency, East Java, Indonesia. The variables studied include intangible assets such as moral and emotional intelligence, creative attitudes, institutional culture, and knowledge management. Respondents were employees of the institution and questionnaire were used for data collection. Additionally, quantitative descriptive techniques were utilized for data analysis. The results showed intangible assets such as moral and emotional intelligence, creative attitudes and institutional culture, and knowledge management controlling the intangible assets were efficient.*
Keywords— *intangible assets, evaluation, irrigation system*

I. INTRODUCTION

The agricultural sector plays a very strategic role in national development in Indonesia. The agriculture, forestry and fisheries sector contributed IDR 1,174.5 trillion to GDP in 2015. In general, it comes third after the manufacturing and trade industries [1]. Irrigation is a critical component in the agricultural sector and has the potential to increase yields from 100 to 200% [2] and the Land used plays a significant role in food production. For instance, 85% of national rice production is produced in paddy fields with an area of 4.65 million ha [3].

Irrigation is a socio-cultural system of society which is dynamic depending on the environmental conditions [4]. Nowadays, these ecological situations undergo rapid changes due to the rapid development of information technology, globalization, and democratization. For example, social and political reform in 1998 led to a paradigm shift in the irrigation sector [6]. The change demands irrigation management to be carried out in a transparent, accountable and fair manner. This is a vital intangible asset affecting organizational management processes [7-8] and corporate performance [9-12].

Irrigation system management in Indonesia has prioritized infrastructure aspects, the tangible assets, while intangible aspects such as human, institutional and management receive less attention. This situation weakens intangible assets in the irrigation system, making them perform contrary to the expectations. Additionally, the irrigation water management is not proper, and therefore,

the services have not been optimized. The concept of centralistic operation and maintenance of irrigation lowers the sense of belonging among farmers, leading to a decline in the watering network. As a result, there is a loss of irrigation culture in the farming community system [13]. Moreover, there was an annual shrinkage in farmer participation of 0.045 in the Molecular Irrigation System, 0.033 in the Sapon, and 0.041 in the Mejing for the period 1998-2008 at tertiary level irrigation system management [14]. These conditions reduced the performance and the overall production. Also, knowledge management model controls intangible assets in tertiary and secondary level irrigation system management [15] [16].

II. METHOD

The study was conducted from May to July 2018 in the Water Resources Public Works Office of Malang Regency, East Java. The variables studied include intangible assets such as moral and emotional intelligence, creative attitudes, institutional culture, and knowledge management.

To begin with, the questionnaire of emotional intelligence was compiled referring to [17] states where emotive intelligence has five dimensions, including self-awareness, self-control, self-motivation, empathy, and managing relationships.

Additionally, creative attitude is the point of view which produces something new and useful. It is measured using a scale based on Munandar (1992), stating creative views (operational creativity) as behaviors describing abilities and reflect fluency, flexibility, authenticity in thinking, and elaboration [18].

Moreover, institutional culture is an underlying spirit in managing organizations. It is developed from the habits, beliefs, understandings, and the fundamental philosophy through the process of socialization and interaction. It ensures rules are formed as guidelines for thinking and acting to achieve the goals of the organization. Institutional culture is measured using the cultural scale compiled by referring to the theory of Miller (1987) which states that there are eight principles, including values, consensus, intimacy, unity, integrity, excellence, empirical and achievement [19].

The American Productivity and Quality Center (APQC) defines knowledge management as a systemic approach which helps in the emergence and flow of information and awareness to the right people at the precise

time and creates value. The most important thing in knowledge management is creating a conducive erudition environment, which motivates employees to continue learning, utilize the information provided, build their understanding and share new understandings [20]. Importantly, the knowledge management elements at tertiary level include learning organizations, administrative principles, policies, strategies, and information and communication technology. Learning is a corporate activity which improves mastery of knowledge, skills, professionalism, and other essential aspects (Senge, 1990). The concept is measured based on Senge (1990) which states that learning organizations have five disciplinary principles, including systems thinking, mental models, adult personalities, shared vision, and team learning [21].

Also, the principle of organization needs to be considered for the institution to run smoothly and be effective [22]. It is measured based on a theory by Manullang (1994) and consist of (i) the formulation of clear objectives, (ii) division of labor and delegation of power, (iii) range of influences, (iv) levels of supervision, (v) unity of command and responsibility and (vi) coordination [23].

Furthermore, a policy is a formula prepared and functions as an internal guideline for the activities of an organization (David, 2004). Organizational strategy is a way of achieving long-term goals (David, 2004). It is a unified, broad and integrated plan connecting effective policies with environmental challenges. In general, it is designed to ensure the main objectives are achieved through proper implementations (Gluech and Jauch, 1989). Organizational policies and strategies are measured based on the scale proposed by David (2004) and Gluech and Jauch (1989). Another key aspect considered in is how these two aspects are understood and implemented in irrigation system management.

Also, information and communication technology collects, process, store, analyze and disseminate info for specific purposes (Turban, et al., 2007). It is measured based on Turban et al. (2007), considering how it is understood and used in irrigation system management.

The respondents in this study furthermore were employees of the Water Resources Division of the Water Resources Public Works Office of Malang Regency. Questionnaires were used for data collection, while quantitative descriptive techniques were used for analysis. Importantly, the intangible assets of irrigation systems were categorized into five classes based on the normal distribution model (Azwar, 2004). This method assumes the subject scores in the population are normally distributed. Categorization is relative, and therefore, the area of the interval is determined as long as they are within reasonable and acceptable limits as follows:

	$X \leq (\mu - 1,5 \sigma)$	very poor category
$(\mu - 1,5 \sigma)$	$< X \leq (\mu - 0,5 \sigma)$	poor category
$(\mu - 0,5 \sigma)$	$< X \leq (\mu + 0,5 \sigma)$	moderate Category
$(\mu + 0,5 \sigma)$	$< X \leq (\mu + 1,5 \sigma)$	good category
$(\mu + 0,5 \sigma)$	$< X$	very good category

III. RESULTS AND DISCUSSION

A. *The Office of Public Works Water Resources of Malang Regency*

The Office of Public Works Water Resources of Malang Regency aims to help farmers increase agricultural production by improving the availability of irrigation water and boost their yields. Additionally, it also aims at improving the quality and quantity of facilities to enhance management of water power for irrigation and infrastructure to control the damages. The goals to be achieved include (1) optimizing the use of water sources by building reservoirs/reservoirs, (2) protection of springs and water catchment areas, (3) utilization of resources to fulfill irrigation water needs and expand technical network services; and (4) continuous handling of irrigation networks and synergy between the Central Government and the Provincial and District Administrations as well as with the community.

In general, the organization has the following duties, (1) to carry out local government affairs based on the principle of autonomy, and co-administration and (2) carry out other tasks given by the Regent. To manage these duties, the institution performs the following functions, (1) data collection, management and control through database and analysis for program activities, (2) strategic planning at the Public Works Agency for Water Resources, (3) formulating technical policies on water resources, (4) administering government affairs and public services, (5) fostering and implementing tasks, (6) monitoring, controlling and evaluating and reporting on the water power, (7) implementation of minimum service standards, (8) secretarial organization, (9) guiding the Technical Implementation Units, (10) coordination, integration and synchronization of activities in the Dinas Public Works Water Resources, (11) licensing and implementation of services, (12) guiding the community on water resources and (13) the implementation of cooperation with government institutions and other players. Essentially, the human resources of the Public Works Department consists of 209 individuals, 82 in the head office and 127 in the Technical Implementation Unit of Bululawang, Dampit, Gondanglegi, Kepanjen, Ngajum, Ngantang, Tumpang, Singosari, and Turen. The types of services offered include technical recommendation for (1) the Use of Canal and/or River, (2) Changing the Status of Wet Soils to Dry Land (Transfer of Irrigated Land Functions), (3) Establishment of Buildings on Public Waters (Bridges), (4) Strengthening Talents / Cliffs, (5) Overcoming Floods (Peil Floods) and (6) Use of Land Assets owned.

B. *Intangible Assets of The Office of Public Works Water Resources of Malang Regency*

Intangible assets of the irrigation system in Malang district, including moral and emotional intelligence, creative attitudes and institutional culture are presented in Table I.

Table 1. Intangible Assets of Malang Irrigation System

TABLE I. INTANGIBLE ASSETS

Category	Intangible Assets			
	moral Intelligence (%)	emotional intelligence (%)	creative attitude (%)	institutional culture (%)
Very Poor	0,0	0,0	0,0	0,0
Poor	0,0	3,84	0,0	3,4
Moderate	3,4	20,7	10,3	20,7
Good	82,8	65,5	65,5	72,4
Very Good	13,8	7,7	6,8	3,4
Amount	100,0	100,0	100,0	100,0

Table 1 shows 82.8% of the employees have good moral intelligence and show willingness to integrate universal values in their behavior. Furthermore, they are responsible for their actions and understand their consequences, trying not to harm others, and are compassionate.

Notably, 65.5% of the employees have higher emotional intelligence. It is important they have the ability to understand their emotions accurately and consistently, managing emotions well, striving to achieve goals with enough enthusiasm, strong passion and self-confidence and positive thinking. Essentially, they understand the emotions of others from their actions and interact positively with others.

Moreover, 65.5% of workers are very creative with the ability to use ideas in solving a problem, finding various ways of addressing issues and not using just the ordinary approaches, responding, and expressing detailed concepts.

Most employees, 72.4%, have a distinctive institutional culture. In general, their conducts are in line with the objectives of the institution. Decisions are made through consensus and thinking with a view of achieving common goals. Besides, there is an institutional feeling, family relationship, and the welfare of farmers are prioritized. There is also the spirit of learning, giving awards to employees who excel and making decisions based on empirical data.

The education structure affects intangible assets of irrigation systems. From the new order to the reform period, it emphasized teaching and knowledge transfer. This system reduces human capital, such as moral and emotional intelligence as well as creative attitudes. The principles of moral intelligence, including integrity, responsibility, compassion, and forgiveness are outcomes of the quality of one's heart. Nevertheless, self-awareness, self-control,

motivation, empathy, and management of relationships emanate from one's feelings. The education system does not emphasize on feelings and hearts, and as a result, moral and emotional intelligence decreases. This assertion is supported by education expert Rachman (2008), who stated that the national learning system emphasizes on teaching rather than education. Teaching refers to transferring knowledge, while education is forming character, attitudes, morals, and mindset.

Government policies also affect the intangible assets of irrigation systems. In the period where the government dominated the irrigation management, development emphasized economic growth with technical aspects and top-down policies. This led to the shrinking of the institutional culture and creative attitude of irrigation system employees. During the reform period, with the implementation of regional autonomy for employee education, the competence and leadership of the staff still needed to be improved, a situation which caused the shrinking of intangible assets.

Modernization also affects the intangible assets of level irrigation systems. It is a change process which assumes that a mind is a tool of human freedom and thought is capable of controlling nature and society. Rationalization of modern society produces something less flexible and scientifically programmed. The actualization of rationality leads to dehumanization (Sastrapratedja, 1995), shrinking the human capital of the irrigation system.

C. Knowledge Management of The Office of Public Works Water Resources of Malang Regency

Knowledge Management of The Office of Public Works Water Resources of Malang Regency is presented in table II.

TABLE II. KNOWLEDGE MANAGEMENT

Category	Knowledge Management	
	amount	(%)
Very Poor	0	0,0
Poor	0	0,0
Good	19	65,5
Very Good	10	34,5
amount	29	100,0

A mental model is a process of assessing oneself to understand the assumptions, beliefs, and habits valid in helping managers respond to situations in the environment. The model in an ever-changing institution cannot function properly and inhibits the changes for it to be discussed, examined, and revised by farmers, groups, and institutions to accelerate the transformation needed. Notably, Political reforms in 1998 resulted in behaviors difficult to regulate among employees. This is evidenced by changes in the ownership of paddy fields as a result of the economic

development of Malang Regency. The significance of a paddy field decreased, affecting farmers in a manner difficult to regulate. However, the mental model of employees shows the possibilities for improvement. The dynamic ability of the irrigation system manager at the tertiary level is weak since they cannot overcome the consequences of environmental changes.

Unquestionably, the Office of Public Works Water Resources of Malang Regency consists of leaders and employees who need to work together for optimal performance. The success of the institution is primarily determined by its ability to work synergistically. The capacity to build a synergic relationship might only be possessed if all water workers understand the duties of each other and the impact of their performance in their previous work stations.

In general, the institution has various employees with different educational and experience backgrounds. This makes it difficult to work in an integrated manner, primarily due to the lack of the same vision. Fundamentally, a vision must be shared by all employees and departments to move the institution ahead. Although employees may be sharing activities almost every day, they still need to improve.

There is need for employees with high competence to adapt to the demands of change. For this reason, all workers must show willingness to improve their expertise by continuing to study. Competence is not solely in the knowledge and skills, but the ability to interact with other employees, resolve conflicts, and appreciate each other's work.

The ability of institutions to harmonize team activities is determined by shared vision and systemic thinking skills. Without sharing ideas on successes and failures in a team, learning might be very slow. It might be faster if employees want to share insights and learn together. Therefore, the spirit of learning in teams, success stories and failures must be conveyed to the other groups. Sharing knowledge and ideas within the team is very important in increasing the capacity of institutions to enhance their intangible assets. This aspect has been considered in The Office of Public Works Water Resources of Malang Regency but still needs to be improved.

IV. CONCLUSION

The results showed the Office of Public Works Water Resources of Malang Regency has (i) intangible assets consisting of moral and emotional intelligence, creative attitudes and institutional culture, all in good categories, and (ii) knowledge management in controlling the intangible assets was also good.

ACKNOWLEDGMENT

The authors express gratitude to the Directorate General of Research and Development Empowering, Ministry of Research, Technology, and Higher Education of the Republic of Indonesia for funding the study.

REFERENCES

- [1.] Central Bureau of Statistics. (2016). Official News Statistics 2016
- [2.] Kurnia, U. (2004). Prospects for Agricultural Irrigation of Dry Land Seasonal Plants. *Jurnal Litbang Pertanian* 23(4)
- [3.] Pasandaran, E.P, Simatupang, dan A.M. Faqi. (2006). Perspective of Rice Production in Indonesia. Dalam Sumarno, Suparyono, A.M. Faqi dan M.O. Adnyana (Eds) *Rice Industry, Culture, and Environment*, Book I. Indonesia Center for Rice Research (In Press)
- [4.] Pusposutardjo, S. (2004). *Persoalan dan Penyelesaian Manajemen Irigasi Yang Berkeadilan*. Paper Seminar on Subak Systems in Bali Facing the Globalization Era, Denpasar, August 16 2004.
- [5.] Garvin, D. (2000). *Learning in Action: A Guide to Putting the Learning Organization to Work*. Harvard Business School Press.
- [6.] Arif, S.S. (2005). *Operasi dan Pemeliharaan (O&P) Irigasi Masa Depan: Sebuah Gagasan dan Upaya Menghadapi Tantangan*. Paper discussion with the Banyumas Regency Water Resources Office, Purwokerto
- [7.] Stewart, T.A. (1999). *Intellectual Capital*. Doubleday Dell Publishing Group, Inc. New York. 280 hal.
- [8.] Engstrom T.E.J, Petter W. and Siren F.W.(2005). Evaluating Intellectual Capital in the Hotel Industry. *Journal of Intellectual Capital* 4(3):287-303
- [9.] Bontis, N.(1998). Intellectual Capital: An Exploratory Study that develops measure and model. *Management Decision* .36(2)63-76
- [10.] Bontis, N., Keow, W.C. and Rechardson, S. (2000). Intellectual Capital and Business Performance in Malaysian Industries. *Journal of Intellectual Capital* 1(1)85-100
- [11.] Cabrita, M.R. and Jorge, L.V. (2005). Intellectual Capital and Value Creation: Evidence from Portuguese Banking Industry. *Electronic Journal of Knowledge Management* Vo.4 Issue 1 pp 11-20
- [12.] Sampurno, H. (2005). *Peran Aset Nirwujud pada Kinerja Perusahaan : Studi Pada Industri Farmasi Indonesia*. Post-Graduate Dissertation of the Faculty of Economics UI
- [13.] Santosa, B. (2004). Presentation in Journalist Workshop on Water Policy Issues in Indonesia. www.adb.org/document/event/2004/ino
- [14.] Waskitho, N.T., Arif, S.S., Maksum, M., and Susanto, S. (2010). Study on Amortization in Irrigation System Management Using Knowledge Management Approach. Makalah dalam Konferensi ICID Regional Asia ke-6, 10-16 Oktober 2010, Yogyakarta
- [15.] Waskitho, N.T., Arif, S.S., Maksum, M., and Susanto, S. (2012). Model of Intangible Assets Controlling in Management of Tertiary Irrigation Systems. *Jurnal Agritech* 32(3)
- [16.] Waskitho, N.T. and Djudiah. (2016). Controlling Model of Intangible Assets in Secondary Irrigation System Management. *Current Agriculture research Journal* 4(1)
- [17.] Bradberry, T.R. & Greaves, J.M. (2005), *the Emotional Intelligence Appraisal*, Technical Manual. San Diego: Talent Smart, Inc.

- [18.] Munandar, S.C.U. (1992) Mengembangkan Bakat dan Kreativitas Anak Sekolah. Gramedia. Jakarta.
- [19.] Miller, M., B.D. DuPont, V. Fera, R. Jeffrey, B. M. Payer dan A. Starr. (1999) Measuring and Reporting Intellectual Capital From a Dierce Canadian Industry Perspective: Experiences, Issues and Prospect. OECD Symposium. Amsterdam
- [20.] Tjakraatmadja, J.H. dan Donald C.L. (2006) Knowledge Management dalam konteks Organisasi Pembelajar. Sekolah Bisnis dan Manajemen ITB Bandung
- [21.] Senge, P.M. (1990) The Fifth Discipline: The Art and Practice of the
- [22.] Learning Organisation. New York: Doubleday
- [23.] Manullang. (1994) Manajemen Personalia. Penebar Swadaya, Jakarta
- [24.] Manullang. (1994) Manajemen Personalia. Penebar Swadaya, Jakarta
- [25.] David, B.2004. Organizational Behaviour: An Introductory. Prentice Hall
- [26.] Gueck, W.F and L.R. Jauch. (1989) Business Policy and Strategic Management. McGraw-Hill
- [27.] David, B.2004. Organizational Behaviour: An Introductory. Prentice Hall
- [28.] Gueck, W.F and L.R. Jauch. (1989) Business Policy and Strategic Management. McGraw-Hill
- [29.] Turban, E.,D. Leidner, E. Melean and J. Wetherbe. (2007) Information Technology for Management: Transforming Organization in the Digital Economy. Wiley
- [30.] Turban, E.,D. Leidner, E. Melean and J. Wetherbe. (2007) Information Technology for Management: Transforming Organization in the Digital Economy. Wiley
- [31.] Azwar, S. (2004). Penyusunan Skala Psikologi. Pustaka Pelajar. Yogyakarta
- [32.] Rahman, A. (2004). Pendidikan Indonesia Masih Mengutamakan
- [33.] Pengajaran.
<https://www.erasuslim.com/berita/nasional/arief-rahman-pendidikan-indonesia-masih-utamakan-pengajaran.htm>
- [34.] Sastrapratedja, M (1995) Modernity, Globalization
- [35.] and Its Impact. in the Globalization of Culture and Resistance of Ideology, Aditya Media, Yogyakarta

The Era of Abundance and its Impact on Indonesia Higher Education

Gembong Baskoro
 Master of Mechanical Eng. Dept.
 Swiss German University
 Tangerang, Indonesia
gembong_baskoro@yahoo.com

Abstract— *The disruption era that leads to the awareness of higher education to cope with Industry 4.0, especially due to the rapid Information Technology (IT) development of Internet of Things (IoT), Big Data, Robotic, and Artificial Intelligence (AI), etc. especially for the transformation into digital industry, is now becoming a new pathway for many higher education institutions (HEI). Higher education institutions try to adapt and or adopt their curricula in order to align with industry 4.0. It is the nature of higher education that operate in Teaching, Research, as well as Community Service that need to adapt with the fast changing of its strategic environment. The question is for how long the era of disruption will last, and what the forthcoming era that higher education must prepare. This is important for HEI in order to ensure sustainability of the strategy especially when strategic environment change rapidly.*

This paper will elaborate to new predicted era, the so-called Era of Abundance, that will be faced after the era of disruption. Before elaborating the “abundance”, it is important to elaborate the comprehensive strategy due to “disruption” in HEI, the so-called Education 4.0, especially in aligning with Industry 4.0. This paper will also elaborate the what-is of the era of abundance so that by having understanding of this era, higher education can take the advantage of time. This paper uses method of descriptive analysis based on expert opinion to elaborate and to draw the conclusion.

Keywords— *Era of abundance, Disruption, Education 4.0, Higher Education, Industry 4.0*

I. INTRODUCTION

The wave of industry 4.0 will soon or perhaps already shape a new way of higher education system. It is just a matter of time, regardless the readiness, for the change in higher education to take place. What kind of changes in higher education that will take place are, hopefully, predictable? The prediction can be made by looking at the nature of Industry 4.0 that are related to the development of industry based on recent development of technology especially related to IT. This is due to the fact that volume of IT utilization has growing rapidly so that new adaptation of the situation is required.

In the recent issues in higher education raised for the awareness of Industry 4.0 seems that policy made by government authority was to ensure smooth transition and adaptation in higher education system to cope with the possible change. For example: the new “nomenclature” for study programs has adapted with needs for industry 4.0. This indicate that the expectation from government authority regarding the output of higher education can adapt smoothly to the need of

industry with 4.0 system. If the change in higher education is to fit with external change in industry due to the recent development of (IT related) technology, then for how long the change will last. As we may agree that “changes” is constant and will not stop to industry 4.0, therefore it is important to make a sound academic prediction after the era of industry 4.0 the so called “era of abundance”. This is the era after the disruption that lead to industry 4.0 [4][5][6].

For this reason, this paper will discuss from any angel about “era of abundance” so that we can understand it. By understanding it, we can develop scenarios towards adaptation of “era of abundance” and develop plan for smooth transition scheme.

II. THE “ERA OF DISRUPTION”

The new paradigm thinking of the especially technology development is the nonlinear thinking which is exponential curve. The exponential growth was according to the “Law of Accelerating Returns” by Ray Kurzweil and Peter Diamandis, in his book of “The age of spiritual machines” show that technology development follows the so called “6D Exponential Growth” i.e. 1. Digitalization, 2. Deception, 3. Disruption, 4. Dematerialization, 5. Demonetization, and 6. Democratization (Fig. 1) [7].

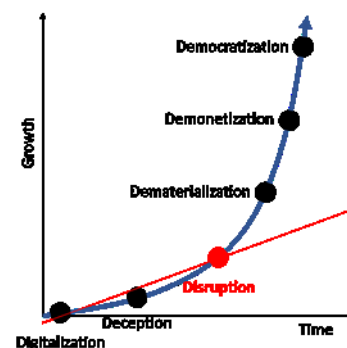

Fig. 1. The 6D Exponential Growth

Digitalization indicated transformation into digital technology; Deception is a period when the growth is unnoticed into exponential; Disruption is a period of growth into exponential, it is an era that growth is taken place so fast; Dematerialization is a situation in which products are no longer in the physical appearance such as “cloud”; Demonetization is a situation in which cost is no longer dominant due for example to impact of dematerialization; Democratization is a situation

in which technology can be afforded by everybody, it is due to the “era of abundance” at a low cost.

We are now living in the era of Disruption and slowly but sure moving to the era of abundance. Impact on the disruption era depends on the readiness to cope with “Change” and not surprisingly with “rapid change” due to explosion of technology development in especially those related with industry 4.0. For example, we are now getting familiar with any online business that hardly kill the traditional business. We can order food, or anything simply using mobile phone. To do so we don’t need to show up in physical. Now, we already live in the “world of IT”.

III. THE NEW “ERA OF ABUNDANCE”

The era of abundance is possible due to the so called “democratization” in the 6 D exponential growth (Fig. 2). It is perhaps what we are looking for, the new era of “Free Economy”. We can get what we want for free or if you have to pay then it is very cheap such as book, music, film, you name it. This sounds not make sense in the recent traditional economic system that we used to know. However, slowly but sure technology has changed the way we live that will impact to the current economic system. For example, now we can learn what we want to know simply using any social media. The era of abundance challenges our traditional economic system that lead to two possibilities i.e. the status quo will see this as a threat, while the positivist will see it as opportunity.

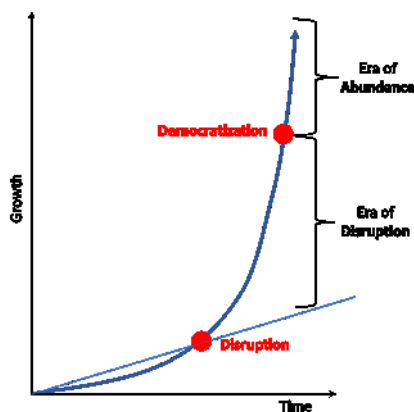

Fig. 2. Era of Disruption and Abundance

The prediction of “Era of abundance” will take place around year of 2035-2040 [7]. In this era most of the jobs handled previously by human will be taken over by artificial intelligent machine. Consequently, product made by machine can be affordable due to the very low cost. Consequently the “democratization” of technology will apply as most people can afford the technology. It is reasonable because, as predicted, not much people with very low income anymore.

Although “the era of abundance” will provide more opportunities, it has also threat that need to be carefully managed. This paper tries to forecast and establish scenarios to avoid threats and maximize the opportunities for higher education. For example, in traditional learning system, interaction between students and lecturer takes place in the class assisted by any technology available. In the era of abundance where technology available with affordable cost, then what kind of learning system will be applied. Are higher education institutions prepared for this? and how far they have adapted.

IV. HIGHER EDUCATION SYSTEM AND ITS POSSIBLE ADAPTATION

The mission of Indonesia Higher Education known as “Tri-Dharma” i.e. 1. Teaching, 2. Research, and 3. Community Service (Fig. 3). Therefore, any higher education institution (HEI) must perform the “Tri-Dharma” with all resources available in the institution. Therefore, “resources” play an important role towards the effectiveness, and efficiency of the institution to perform the Tri-Dharma.



Fig. 3. The “Tri-Dharma” of Indonesia Higher Education

The important resources for HEI namely 1. Infrastructure, 2. People, 3. Financial, 4. Management/system, 5. Technology, 6. Laboratory, 7. Library, 8. Etc. Having these resources HEI manage to performs their Tri-Dharma mission with high quality as possible. Therefore, not surprisingly that each HEI develop their uniqueness and innovativeness based on the strength and weakness of their available resources.

Era of disruption and abundance will directly or indirectly give impact to HEI resources, consequently will impact to the way HEIs perform the Tri-Dharma as well. For example, in the era of abundance when books are already free to anyone then HEI may not invest Library as today, a room full of text book. Similarly, when everybody has smart phone installed with social media software in it then do, we still need to have face to face interaction in class for 14 times a semester. Also, when laboratory exercise can be shared using IT technology then do, we still need to invest our own laboratory, why not share with other. Ultimately, if there is possibility for free education then what higher education will look like in the future. How they will survive for the sustainability.

Considering the future possibilities impacted by era of abundance therefore higher education institutions should develop a roadmap towards transformation their existing system to respond and adapt with era of disruption then era of abundance. The transformation may impact to two possibilities 1. Invest new technology, 2. Divest or redefine unutilized recourses. These possibilities of courses will directly or indirectly affect to the way to perform tri-dharma. For example, if HEI invest in IT technology for online-distance learning then the unutilized room must be divested or converted to other activities other than learning. It is because in online-distance learning no class is needed but non-physical interaction. What about HEI that has inability to invest in IT Technology due to financial disability that lead to low intake. For this situation then the HEI must find the way of operating institution with low intake and afford income generation from sources other than student intake. Is it possible? yes as long as the institution can manage high quality of human resources

then their productivity can be shifted partly from teaching to research, consultancy, or other. Other possibility is the qualified resources available in an HEI may be shared with other institution in or outside country that need most.

Today, government authority suggests for HEIs that face difficulty to do merger so that they have competitiveness to face in the era of disruption and era of abundance. This policy is in fact reasonable as the combine strengths and reduce weaknesses of the HEIs enable them to have new competitiveness required to compete in the recent era of Industry 4.0.

V. CONCLUSION

The opportunity of the era of abundance is a form of democratization of technology that lead to new economy mindset. In term of economy the “almost” free economy enables people to have good quality of life than before. In term of user this is the great opportunity. However, in term of the player, for example HEI, it can be a threat if it is not wisely managed.

Therefore, for HEI to be sustained then they have to wisely managed by means of making road map toward their sustainability. Prioritization of development of the available “resources” considering very important factors. This is due to the fact that Era of Abundance will impact to the resources of HEI whether it become fully utilized or underutilized.

HEI must wisely set the quality of the resources and have the new mindset for the upcoming era of abundance. HEI must think out of the box, and not bind themselves to the rigid form of system that make them difficult to adapt with external change.

Finally, HEI need a typical leadership that can bring the institution to face the new era of abundance. It is the type of leadership that can connect technology, people, and other resources effectively. The type of flexible and innovative leadership that has broad range connectivity and able to maximize for making the change of organization toward its sustainability.

REFERENCES

- [1] G. Baskoro, “Challenges and Opportunities of Higher Education Institution in the disruption era towards Education 4.0”, Paper presented at the Technopex 2018, ITI, 2018
- [2] P. H. Diamandis, S. Kotler, “Abundance: The Future is Better than You Think”, Free Press, 2012
- [3] P. H. Diamandis, S. Kotler, “Bold: How to Go Big, Create Wealth, and Impact the World”, Simon & Schuster, 2015
- [4] A. Mukti, “Strategi Pengembangan Karir Jafung Dosen”, Semnas ABPPTSI dan Kemenristekdikti, 2019
- [5] S. Patdono, “Strategic Inflection Point pada Pendidikan Tinggi”, Semnas ABPPTSI dan Kemenristekdikti, 2019
- [6] RistekDikti, “Sarasehan & Dialog Nasional Menristekdikti RI Bersama ABPPTSI”, 2019
- [7] R. Kurzweil, “The Age of Spiritual Machines: When Computers Exceed Human Intelligence Free”, Penguin Books, 2009

Motivation of Culinary Tourism Visitors in Santa Market Kebayoran Baru

line 1: 1st Nurbaeti
 line 2: *Hospitality and Tourism*
 line 3: *Sekolah Tinggi Pariwisata Trisakti*
 line 4: Jakarta, Indonesia
 line 5: nurbaeti@stpтрisakti.ac.id

line 1: 2nd R.M.W. Agie Pradhipta
 line 2: *Hospitality and Tourism*
 line 3: *Sekolah Tinggi Pariwisata Trisakti*
 line 4: Jakarta, Indonesia
 line 5: agiepradhipta@stpтрisakti.ac.id

line 1: 3rd Fifi Nofiyanti
 line 2: *Hospitality and Tourism*
 line 3: *Sekolah Tinggi Pariwisata Trisakti*
 line 4: Jakarta, Indonesia
 line 5: fifi.nofiyanti17@stpтрisakti.ac.id

Abstract— Along with the times, culinary tourism is in great demand by the people, culinary tourism is growing rapidly because the ideas developed are very unique and varied, thus increasing peoples motivation to enjoy culinary trends in Jakarta, one of which is in Santa's Market, Kebayoran Baru. This study aims to determine the characteristics and motivations of visitors to a culinary tour in Santa's Market, Kebayoran Baru. The method used is qualitatif descriptive method. The procedure of data collection was done by distributing questionnaires to 100 visitors who had a culinary tour at Santa's Market on the weekend. Based on the results of the study, cultural motivation got the highest average value of 4.11, fantasy motivation got an average value of 3.98, and physical motivation got an average value of 3.74 and social / interpersonal motivation had value the lowest average is equal to 3.57. The results of the study with an average of 4.82 showed that visitors were motivated for a culinary tour in Santa's Market. The results of this study found that visitors' motivation in culinary tourism in Pasar Santa is dominated by cultural motivation, because to enjoy new culinary, relax together, and to enjoy favorite culinary delights in the market.

Keywords—*motivation, Santa's market, culinary tourism*

I. INTRODUCTION (HEADING 1)

Today's culinary tourism in Jakarta is increasing, activities and shopping habits are not only for fulfilling daily needs, but have begin to lead to consumptive patterns and increasing tertiary needs accompanied by the development of "life-style". Moreover, culinary tourism is now one of the current trends and cool place to gather. Since social media side by side with people's lives, there are many things that we can see and finally visit. Sometimes consumers are not only for enjoy culinary, even to capture it in photos and uploaded to social media.

Travel trends in this era make people choose attractive tourist locations for weekends and holidays. Tourists who come to a tourist destination have a variety of main destinations, including: natural destinations, artificial destinations, culinary, cultural, and shopping centers. It is undeniable that traveling with the aim of enjoying culinary in tourist destinations. The food served is regional specialties

and modern food. This makes tourists interested in visiting an area, for example, the tour to Medan is famous for *Ucok durians*, tours to Yogya are famous for *bakpia, gudek*, and others.

Jakarta is a location that hits young people for hangouts or work meetings. Kebayoran Baru, a sub-district located in the city of South Jakarta. This sub-district is mostly a residential area, although some parts are also shopping areas and business centers. For seven years, from 2007 to 2014, Santa's Market seemed uninhabited and the location was not on the protocol road, but in the middle of the settlement. Now Santa's market is transformed into a millennial place. Santa's Market located in Kebayoran Baru is famous is place the hipsters or known as *AGJ (Anak Gaul Jakarta)*. Santa's Market has all the potential to be more than just a place for young people to hang out, this place can be a creative space and showcase that gives birth to many products and works of young people.

South Jakarta have many markets such as Tebet Market, Minggu Market, Mayestik Market, and Blok M Market. 1st Floor Santa's Market is now transformed like a place to relax and gather young people or known as Foodcourt. PD Pasar Jaya transforms the Santa's Market into thematic and invites traders to be creative in designing their stores. The famous, varied and creative types of food and beverages that are famous in this place include A Bunch of Caffeine Dealers (ABCD), Dudes of Gourmet (DOG), Papricano Mexican Cantina, Judas, Beyond Cendol, Mie Sop Medan, Kedai Kawa, Barnana, Mommadon, Slam Dunk Sandwich Co., Miawcoconutice, and others. Visitors can experience unique and different culinary tours by visiting Santa's Market by offering a variety of unique foods and drinks, of course this will attract so many visitors to enjoy all the culinary tours in Santa's Market. The researcher looked at the background of the problem at Santa's Market. Based on the description above, it is felt necessary to study further about the motivation of visitors to culinary tours in Santa's Market. This is to find out the motivation that underlies visitors for culinary tours at the Santa Kebayoran Market.

II. LITERATURE REVIEW

Besra (2012: 22), Culinary tourism becomes an alternative in supporting the potential of natural tourism, cultural tourism,

historical tourism and marine tourism. This culinary tour is part of the type of tourism that exists, because it is not complete if tourists who come do not try typical cuisine in the area. Although culinary tourism is often considered a complementary tourist product, potential culinary tourism is developed because tourists who come are usually interested in trying out the specialties of the region.

According to Irianto (2005: 53) Motivation comes from the move word which means to move. Motivation is something that moves or encourages a person or group of people to do or not do something. One element of motivation is the motive (= motive, reason, or something that motivates).

According to McIntosh and Murphy in Pitana and Gayatri (2005: 58) Basically someone traveling is motivated by several things. Motivation can be grouped into four groups, namely: a) Physical or physiological motivation, including relaxation, health, comfort, participating in sports activities, and relaxing. b) Cultural motivation, which is the desire to know the culture, customs, traditions and arts of other regions. It also includes interest in various objects of cultural heritage (historical monuments). c) Social motivation or interpersonal motivation, such as visiting friends and family (VFR, Visiting friends and relatives), meeting work partners, doing things that are considered to bring prestige (prestige value), make pilgrimages, escape from boring situation, and so on. d) Fantasy motivation (motivation because of fantasy), namely the existence of a fantasy that in another area someone will be able to escape the daily routine that is tedious, and ego-enhancement.

According to Wijaya, dkk., (2018: 76), motivation in a type of culinary tour is not only an eye for fun and raising the stomach with a variety of unique dishes from tourist destinations, so that interest is motivated. Maslow in Pitana and Gayatri (2005: 59) Motivation of one's journey is influenced by the internal factors of the tourists themselves (intrinsic motivation) and external factors (extrinsic motivation). Intrinsically, motivation is formed because of the needs or desires of the man himself, according to Maslow's hierarchy of needs theory, namely physiological needs, security needs, social needs, prestige needs, and the need for self-actualization. Extrinsically, motivation is formed because it is influenced by external factors such as social norms, influence or pressure.

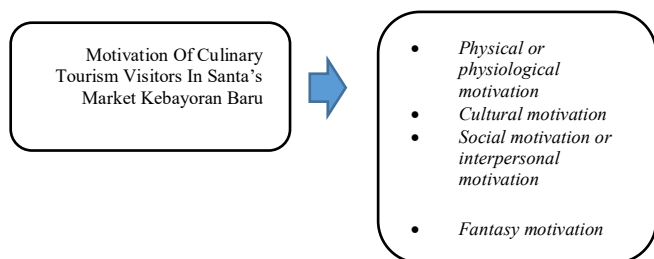

III. RESEARCH METHODS

This research is qualitative descriptive method a systematic depiction of a description or description of a situation as clearly as possible without any treatment of the object under study. This study uses a qualitative descriptive method, because to describe the findings of the motivation of visitors to a culinary tour in Santa Market. Data obtained from

questionnaires, interviews, and surveys. Because to strengthen the results of research.

According to Kusmayadi and Sugiarto (2000: 22), variables are elements of the object under study, a characteristic that is inherent in the object of the research. Based on the relationship between variables is divided into independent variables (independent variables) and dependent variables (dependent variables). In this study using one variable, and the variable used is the dependent variable. Dependent variable is a variable whose value depends or is influenced by other variables. The dependent variable in this study is visitor motivation. For more details, the variables and measurements can be seen in the table below.

Table 1. Variables and Measurements

No	Variable	Sub Variable	Indicator	Measurement Scale
1	Demographics		<ul style="list-style-type: none"> • Gender • Age • Job • Status • Residence • Frequency of visits 	Nominal Interval Nominal Nominal Nominal
2	Visitor Motivation	a. Physical Motivation	<ul style="list-style-type: none"> • Relaxation and relax • See location • Favorite Culinary 	Ordinal
		b. Cultural Motivation	<ul style="list-style-type: none"> • Taste the culinary variety • Looking for entertainment 	
		c. Social / Interpersonal Motivation	<ul style="list-style-type: none"> • A meeting place for friends / family • Choose a culinary tour with friends / family • Increase prestige Make popularity on social media • Business needs 	
		d. Fantasy Motivation	<ul style="list-style-type: none"> • Have their own satisfaction, because they are separated from the routine and meet other socialite groups • Become part of the Santa's Market visitor community, connect and increase prestige 	

Obtaining data on the motivation of visitors visiting Santa's Market, Kebayoran Baru. Kusmayadi and Sugiarto (2000: 94), researchers used a questionnaire using the Likert Scale. Suggesting that the Likert Scale is a tool to measure attitudes from a very positive state to a very negative level to show the extent of the level of agreement or disagreement with the statement submitted by the researcher. The scale developed by Rensis Likert is referred to as Summated Ratings Method.

Pasaribu (2013; 53-54) says that the nominal scale is used to classify objects, individuals or groups (eg male and female). Ordinal scale provides information about the relative number of different characteristics possessed by a particular object or individual (example: level of education). The interval scale has characteristics such as those possessed by nominal and ordinal scales with added other characteristics, namely in the form of a fixed interval (example: age interval, interval of many visits in 1 month).

Kusmayadi and Sugiarto (2000: 127) say that, population is the total number of units of analysis in research in the form of whole elements that have one or several of the same characteristics or characteristics, a collection of individuals with qualities and characteristics that have been applied and a collection of measurements about something that will be examined. The population used in this study is the estimation of the population of visitors who have culinary tours in Santa’s Market. Within a day Santa’s Market is visited by ±400 visitors, judging by the number of parked vehicle tickets, not to mention visitors who use public vehicle and others.

Determine the number of samples determined by using a formula developed by Slovin in Kusmayadi and Sugiarto (2000: 74). To determine the number of samples, the formula from SLOVIN can be used, namely:

$$n = \frac{N}{1 + n(e)^2}$$

Where:

n: Sample size

N: Population size

e: Percent of allowance for inaccuracies due to sample errors that can still be tolerated or desired (10%)

The use of the formula above assumes that the population is normally distributed.

$$\begin{aligned} n &= \frac{12000}{1 + 12000(0,1)^2} \\ &= \frac{12000}{1 + 12000 \times 0,01} \\ &= 99,17 \text{ pengunjung} \end{aligned}$$

So, the number of samples will be taken from visitors who have culinary tours in Santa’s Market as many as 100 people or respondents. Sample from this research were taken from visitors who were given questionnaires in the 3rd floor area, because it was a culinary center and hangout at Santa’s Market.

Data Collection Procedure

The data in this study can be obtained in two ways, namely: a. Primary data and b. Secondary data. According to Kusmayadi (2004: 62), primary data is data collected and processed directly from the source by data users. The data collection used in primary data research is to use:

- Questionnaire

The method of data collection is done by distributing a list of questions to respondents. Questionnaires refer to a collection of questions and statements submitted by researchers to respondents and answers obtained in written form. The questionnaire was used in this study to find out the

response of visitors regarding culinary tourism in Santa’s Market.

- Interview

Interviews are conducted to find out directly on the object of research to find out the problems that exist. Researchers can explore information as completely as possible, which is usually less explored when using a questionnaire. In this study interviews were conducted at Santa’s Market.

According to Kusmayadi (2004: 66), secondary data is data that has been processed and published by another person or party. In this case the intended data is obtained through the literature in the form of reference books, articles from websites, and magazines.

Data analysis method

Based on the data to be obtained later and using descriptive data analysis methods, primary data and secondary data, it will conduct processing and analyzing the data by:

1. Preparation Phase

At this stage it is done by checking data and collecting all data that has been obtained. This stage is done by looking at notes on the results of questionnaires, interviews, and documentation.

2. Data Processing Phase

In this phase an analysis of the questionnaires that have been distributed, interview instruments and documentation is carried out. Analysis of the questionnaire obtained from the responses of 100 respondents was done manually using MS Word, MS Excel and Pie Chart.

3. Stage of Conclusion Withdrawal

In this stage, conclusions are obtained. What motivates visitors to take a culinary tour at Santa’s Market, Kebayoran Baru, to become a culinary destination in Jakarta.

IV. RESULT AND DISCUSSION

Results

Profile of Santa’s Market

Santa’s Market located on Jalan Cipaku, Kebayoran Baru, South Jakarta is under PD Pasar Jaya. Currently PD Pasar Jaya manages 153 markets spread throughout the DKI Jakarta Province, one of which is Santa’s Market, Kebayoran Baru. In the beginning, Santa’s Market was built in 1971, with a land area of 7,328 m2 and building area on the first floor which amounted to 6,047 m2. The beginning of the construction of the Santa’s Market was only one floor with a total of 716 business places. However, on May 15, 2007, the Santa’s Market has been renovated with an increase in building area of 10,953 m2 so that the growing business space in Santa’s Market is 1,151 with details of 483 basement floors, 318 on the ground floor and 350 on the first floor.

Santa's Head of Market, Bambang Sugiarto said that before the Santa’s Market was crowded with visitors, almost eight years the market was quiet. Therefore, Bambang Sugiarto invited several communities to enliven the Santa’s Market. The number of business places in Santa’s Market is 1,151 places, consisting of 350 1st floor business premises, 318 business premises on the ground floor and 483 business

premises in semi basement. On the 1st floor (one) there is culinary, while on the ground floor are knick-knacks, clothes and accessories. Basement location is a seller of basic necessities. Now the Santa’s Market that was present around the 70s is now transformed into a cool place and become a byword among young people for culinary hunting.

The results of data processing to describe the frequency distribution of each category regarding the characteristics of respondents in the questionnaire.

1. Characteristics of respondents

In this study, the author discusses frequency distribution based on sex, age, occupation, status, place of residence and frequency of visits by visitors who are on culinary tours in Santa’s Market, in each category will be illustrated in the following table and pie chart.

a. Gender

Diagram 1. (Demographic Data) Respondents by Gender

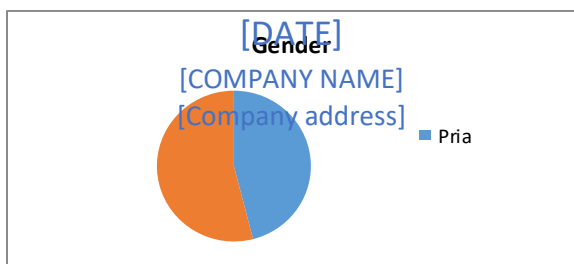

Source: Processed Primary Data Results (2019).

Viewed from the results of the questionnaire, the sex of Santa’s Market visitors who were respondents were male by 46% or 46 people and female respondents at 54% or 54 people. Based on the results of the above data, it can be concluded that female respondents were more than male respondents. Based on the result of data analysis and interviews, there are more woman than men. These conditions indicate that woman have personal pleasure in shopping.

b. Age

Diagram 2. (Demographic Data) Respondents by Age

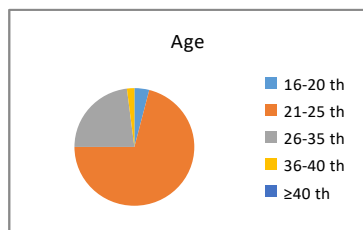

Source: Processed Primary Data Results (2019)

From the results of the questionnaire the number of visitors to Santa’s Market who were respondents based on age was dominated by 16-20 years old 4%, 21-25 years with a percentage of 71%, then followed by the age of respondents 26-35 years old 23%, and then respondents

36-40 years old at 2%, ≥40 years 0%. It can be concluded that the most respondents are 21-25 years old, because that age is still classified as young, people who have a long time, hangout with their friends, and have fun.

c. Status

Diagram 3. Percentage of Respondents Based on Residence Status.

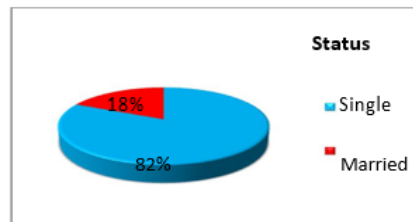

Source: Processed Primary Data Results (2019)

The data can be concluded that unmarried respondents feel more free to do an activity such as spending time with friends, while those who are married prefer peace and a more romantic place, while Santa’s Market almost functions as a hangout rather than a shopping place. Visitors status is 18% single, and then 82% married. It can be concluded that respondents are single feel more free to do an activity like spending time with friends, while those who are married prefer tranquility and a more romantic. Santa’s Market is almost changed function hangout instead of shopping.

d. Work

Diagram 4 (Demographic Data) Respondents by Job

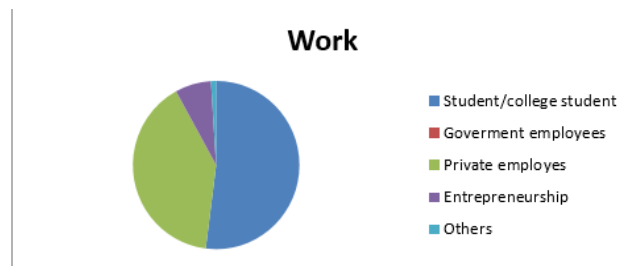

Source: Processed Primary Data Results (2019).

Based on the above data it can be seen the number of visitors to Santa’s Market who are respondents based on work dominated by Students / Students with a percentage of 52%, 40% Private Employees, 7% Entrepreneurs, and 1% other jobs. Santa’s Market attracts more students or collage students, because of the affordable prices, the appearance of live music, there are many culinary choices. The culinary price range at Santa’s Market is IDR 7.000 – IDR 50.000.

e. Frequency of Visits

Diagram 5

(Demographic Data) Respondents Based on Frequency of Visits

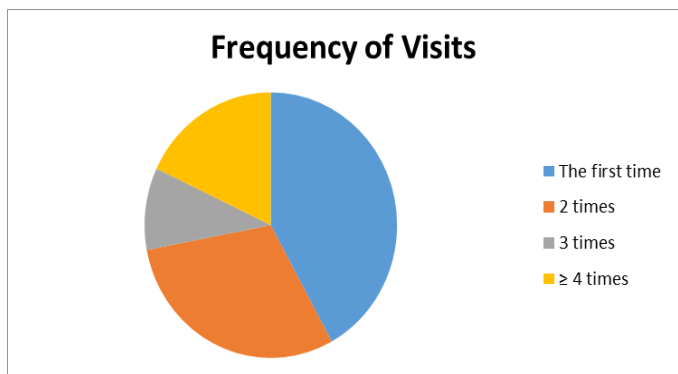

Source: Processed Primary Data Results (2019).

The data above can be known as a percentage of the numbers of frequencies visit of respondents who first raveled to many are 42%, the second response is 30%, respondents 10 % visiting respondents. From these data it can be concluded that the frequency of visits is more dominated the first time to visit, because Santa Market started famous and known to the public in 2014 don't know the location Santa Market, makes many visitors who want a culinary tour at Santa Market.

f. Residence

Diagram 6. (Demographic Data) Respondents by Residence

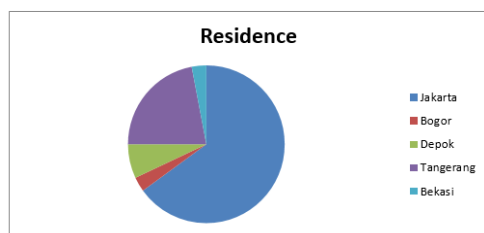

Diagram 6. (Demographic Data) Respondents by Residence

Based on the data above, it can be seen the percentage of visitors to Santa's Market who are respondents based on domicile domiciled in Depok Depok domicile 7%, Bogor and Bekasi domicile 3% It can be said that most of Santa's market visitors are domiciled in Jakarta. Santa's Market is located in South Jakarta, making it easy for visitors especially those who live in Jakarta because it is not far away and access is easily accessible and can use public transportation.

2. Questionnaire Data Analysis

In this section, the results of the study will be attached, namely in the form of statements from respondents who have filled out the questionnaire.

Attached via tables and pie chart diagrams. Then from these results a general data analysis and discussion will be made. By using Motivation theory, according to McIntosh and Murphy in Pitana and Gayatri (2005: 58). There are four sub-variables used in this study, so it is presented in the frequency table and graph below.

a) Physical Motivation

Physical motivation is divided into 3, namely: Culinary tour in Santa's Market on weekends to see the location of Santa's Market, tour in Santa's Market as a place to relax, and tour Santa's Market as a favorite place. The following is the data obtained from the results of the study.

Diagram 7.

Culinary trips at Santa's Market on weekends to see the location of Santa's Market



Source: Processed Primary Data Results (2019).

Based on the data above, it can be seen that as many as 50 respondents 50% said they agreed to a culinary tour in Santa's Market to see the location of Santa's Market. While as many as 27 respondents or 27% stated that they did not agree, 11 respondents or 11% stated strongly agree, 7 respondents or respondents or 5% stated strongly disagree. This is because 50 respondents or 50% are first time visitors and want to see the location of Santa's Market. The data can be concluded that visitors feel comfort to relax and culinary tour in Santa Market, letting go of fatigue from daily work, being able to fiddle from daily work, being able to fiddle with have fun or take pictures. Today's many consumers who come to a place because of viewing from social media or based on information from google.

Diagram 8. Culinary tour at Santa's Market as a place to relax

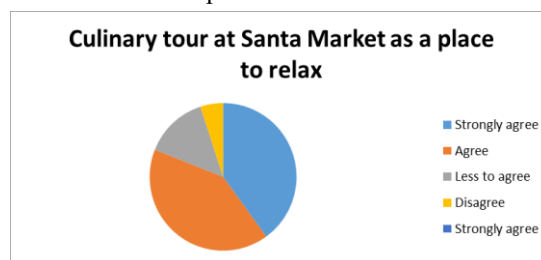

The data can be concluded that visitors feel comfortable to relax and have a culinary tour at Santa's Market, stifle fatigue from their daily work, be able to make fun of gurai, or take pictures themselves there. Responden feel to relax as many 40%, because While 5 respondents stated that they did not agree to the culinary tour in Santa's Market as a place to relax, because visitors felt that the crowds that happened on weekends made visitors not enjoy their culinary tours. Visitors feel a relaxed atmosphere, because Santa Market provides live music while enjoying culinary delights

Diagram 9
Culinary tours at Santa's Market are favorite culinary delights



Source: Processed Primary Data Results (2019).

Because the culture of each market in various regions has different characteristics. Based on the data above, it can be seen that as many as 45 respondents or 45% stated that they agreed about the weekend because there was a favorite culinary or 30% stated that the turtle disagreed, 11 respondents or 11% stated strongly agree and 1 respondent or 1% stated very disagree. This is because visitors agree to a culinary tour at Santa's Market because there are delicious and unique cuisines, one of the most famous and popular ones, namely D.O.G, Gayo Coffee Shop, Michino, Cendol & Duren Bar, Papricano, and others.

b) Cultural Motivation

Cultural motivations or habits are carried out to understand the habits found in Jakarta culinary, especially Pasar Santa.

Diagram 8
Culinary tours in Santa's Market are motivated to taste culinary variety which are available

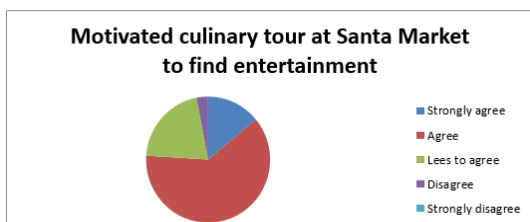

Source: Processed Primary Data Results (2019).

Based on the above data it can be seen that as many as 56 respondents or 56% agreed on the matter that Santa's Market was motivated to taste the available culinary variety, while as many as 40 respondents or 40% stated strongly agree, 2 respondents or 2% stated they did not agree and did not agree, 0 respondents or 0% state strongly disagree.

The data can be concluded because of the variety of foods that are varied, which makes visitors not only enjoy one culinary variety. From the name of the unique food makes visitors interested in a culinary tour in Santa's Market. While the 2 respondents stated that they disagreed because visitors felt that the Santa's Market was still lacking in various Indonesian cuisines.

Based on the above data it can be seen that as many as 62 respondents or 62% agreed on the matter that Visiting Santa's Market at the end of the week to look for entertainment, while as many as 21 respondents or 21% stated that they did not agree, 14 respondents or 14% stated very agree respondent or 3% stated disagree and 0 responds or 0% stated strongly disagree.

c) Social or Interpersonal Motivation

Diagram 10
Motivated by thinking or culinary at Santa's Market with friends or family

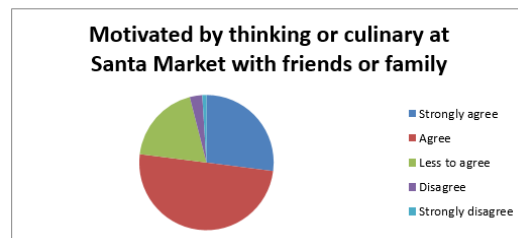

Source: Processed Primary Data Results (2019).

Based on the above data it can be seen that as many as 50 respondents or 50% agreed that the culinary tour at Santa's Market with friends or family, while as many as 27 respondents or 27% stated strongly agree, 19 respondents or 19% stated that they did not agree, 3 respondent or 3% stated disagree and 1 respondent or 1% stated strongly disagree. Visiting culinary tours is more fun with friends or family. Because according to respondents enjoying culinary alone do not feel sensations and feel lonely. But with friends and family, they feel a sense of friendship and can share culinary sensations, or can capture them through photos. One purpose of the tour is to strengthen brotherhood, so that social motivation to enjoy culinary at Pasar Santa is more fun with friends or family

Diagram 11
Motivated Culinary tours in Santa’s Market add to your prestige

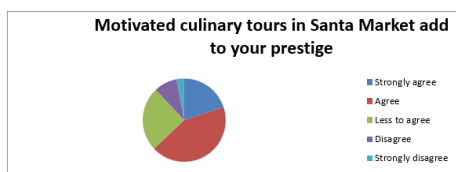

Source: Processed Primary Data Results (2019).

Based on the above data it can be seen that as many as 43 respondents or 43% agreed that the culinary tour at Santa’s Market at the weekend adds prestige, while as many as 25 respondents or 25% stated that they disagreed, 20 respondents or 20% stated strongly agree, 9 respondents or by 9% said they did not agree and 3 respondents or 3% stated strongly disagree. Cultural motivation has the highest percentage of value which causes many visitors to culinary tours in Santa’s Market to taste culinary variety with an average of 4.34 and for entertainment they have an average of 3.87. These results indicate that visitors have more culinary tours at Santa’s Market because they want to taste the various culinary styles, because Santa’s Market is one of the most unique and innovative new culinary tourist attractions in Jakarta, so visitors feel attracted to a culinary tour in Santa’s Market, Kebayoran Baru.

The last motivation is motivational fantasy. Motivated Culinary tours in Pasar Santa have their own satisfaction for you, because you are separated from your daily routine and meet the people other socialites.

Diagram 12. Fantasy Motivation

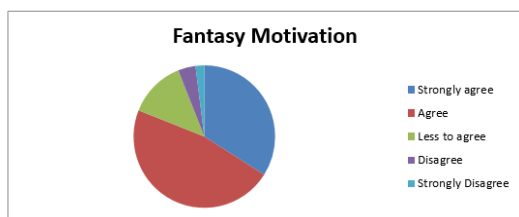

Based on the above data it can be seen that as many as 47 respondents or 47% agreed to the matter has its own satisfaction for visitors, because it detaches from the routine everyday and meet groups 34 respondents or 34% stated strongly agree, 13 respondents or 13% stated less to agree, 4 respondents or 4% stated disagree and 2 respondents or 2% stated very not agree.

Discussion

The results of data analysis using the mean to get the motivation level of culinary tourism in Santa Market found the following results. Fantasy motivation ranks with an average value of 3.98 visitors feeling satisfied for themselves because when a culinary tour at the Santa’s Market visitors can get rid of fatigue from their daily routine, visitors can also meet with other socialite groups with average scores or 4.07. Visitors agree because visitors are part of the Santa’s Market community, visitors can develop friendship connections and increase prestige with an average rating of 3.88.

Cultural motivation in culinary tours in Santa’s Market as a place to relax has an average value of 4.16, visitors feel Santa’s Market is the right place to spend leisure time, while to see the location of Santa’s Market has an average value of 3.55 and visitors can taste culinary Their favorite because of the delicious and unique cuisine makes visitors want to taste the culinary again with an average value of 3.52. And the last motivation is the social / personal motivation in which Santa’s Market is a suitable place and suitable for culinary trips with friends / family because because in addition to being motivated from within themselves, visitors more agree that with culinary tours with family / friends can make a trip, and also strengthen their friendship / kinship, visitors can add to their prestige after a culinary tour at Santa’s Market, especially for those who first visit with an average value of 3.68. Whereas as a place to make friends or meet friends / family with an average value of 3.50 and visitors choose culinary tour reasons at Santa’s Market to make popularity in Social Media 3.36 and the last one is because there are business needs to be the lowest value that is, with an average value of 3.33 because visitors feel that they are a culinary tour in Santa’s Market to enjoy culinary and seek entertainment not for business purposes. Of the four motivations above, respondents can be stated that cultural motivation is one of the reasons visitors visit culinary tours in Santa’s Market with the highest percentage average of 4.34. The results of this study show that visitors to a culinary tour at the Santa’s Market due to tasting culinary variety are available at Santa’s Market.

REFERENCES

- [1] Besra, Eri, Potensi Wisata Kuliner dalam Mendukung Pariwisata di Kota Padang, *Jurnal Riset Akuntansi dan Bisnis*, 2012. (1), pp.14-28.
- [2] I Gde Pitana dan Putu G. Gayatri, G, *Sosiologi Pariwisata*, Yogyakarta: Andi Offset, 2015.
- [3] Irianto, Anton. *Born to win, Kunci yang tak pernah gagal*, Jakarta: Gramedia Pustaka Utama, 2005.
- [4] Kusmayadi dan Sugiarto, Endar. *Metode Dalam Bidang Kepariwisata*. Jakarta: PT Gramedia Pustaka Utama. 2000.
- [5] Sugiyono, *Metode Penelitian Bisnis*, Bandung: CV. Alfabeta, 2004.
- [6] Nabila, Raisa, From: <https://www.ziliun.com/fenomena-pasar-santa-tempat-hipster-atau-ruang-kreatif/>. 2018.
- [7] Restu, Adysta Pravitra, from: <http://megapolitan.kompas.com/read/2014/09/15/08191751/Menyulap.Pasar.Santa.Jadi.Tempat.Nongkrong.Anak.Muda>, 2014.
- [8] Wijaya, D Nata, dkk. (2018). Pengaruh Gaya Hidup dan Motivasi Terhadap Keputusan Pembelian : Survei pada Konsumen Starbucks, Kota Malang. *Jurnal Administrasi Bisnis*. 55 (2). 75-83.

The Factors of Destination Image, Destination Satisfaction, and Marketing Communication That Affect Destination Loyalty

1st Retno Widowati
Management

University Muhammadiyah of Yogyakarta
Yogyakarta, Indonesia
wati630421@yahoo.com

2nd Adhianty Nurjanah
Communication Science

University Muhammadiyah of Yogyakarta
Yogyakarta, Indonesia
adhianty.nurjanah@yahoo.co.id,
adhianty@umy.ac.id

3rd Muhammad Miftahun Nadzir
Management

University Muhammadiyah of Yogyakarta
Yogyakarta, Indonesia
mifta.hunadzir@gmail.com

Abstract— *The tourism sector provides an important role in growing the economy of a region. This condition is in line with the development of increasingly rapid information technology so that it requires the actors of this sector to develop access to their customers, especially in attracting customers or foreign tourists. Indonesia which has a cultural heritage site that is also a world heritage has its own charm.*

This research will be conducted to examine the factors of destination image, destination satisfaction and marketing communication that affect destination loyalty. This study was conducted on customers (tourists) visiting Yogyakarta especially Borobudur temple. This study used a qualitative approach, with the object of research customers (tourists) visiting Yogyakarta especially Borobudur temple.

Keywords— *Destination Image, Destination Satisfaction, Marketing Communication, Affect Destination*

I. INTRODUCTION

The tourism sector provides an important role in growing the economy of a region. This condition is in line with the development of increasingly rapid information technology so that it requires the actors of this sector to develop access to their customers, especially in attracting customers or foreign tourists. Indonesia which has a cultural heritage site that is also a world heritage has its own charm. Indonesia has to find way to promote the tourist destination to be revisited by the tourist or even become the most favorite destination. In the 21st century, loyalty is considered an activity which companies carry out to protect the market shares. Customer loyalty is considered a significant gain in competitive markets. Obviously, loyalty is no longer the exclusive to the product/brand marketing. Similarly, destinations can be considered as products, and tourists may revisit or recommend destinations to other potential tourists such as friends and relatives. Destination loyalty as the level of tourists' perception of a destination as a good place, one that they would recommend to others.

This research will be conducted to examine the factors of destination image, destination satisfaction and marketing communication that affect destination loyalty. This study was conducted on customers (tourists) visiting Yogyakarta especially Borobudur temple. This study used a

qualitative approach, with the object of research customers (tourists) visiting Yogyakarta especially Borobudur temple.

II. RESEARCH OBJECTIVE

The research method used in this research was case study method. The selection of case study method was because the researcher aimed to conduct the study in a systematic way through observation, data collection, data analysis until reporting research how to examine the factors of destination image, destination satisfaction and marketing communication that affect destination loyalty. This study was conducted on customers (tourists) visiting Yogyakarta especially Borobudur temple.

This research is included into the type of descriptive qualitative research. Descriptive research according to experts is research for fact-finding with appropriate interpretation. Studying issues in society, as well as specific community settings and situations, including on the relationships of activities, attitudes, views and ongoing processes and the effects of phenomena.

III. LITERATURE REVIEW

1. Destination image (DI)

As a matter of fact, the term of image appears to be diverse in different point of views. Image is the result from the perception customers have in terms of a company^[1]. DI has become one of the most popular subjects in tourism^[2]. The definition for DI most commonly cited in research is that by Crompton (1979a: 18) "the sum of beliefs, ideas and impressions that a person has of a destination". DI plays an important role in tourists' decision-making processes and subsequent travel behavior^[3]. In a word, the more positive the perception of DI, the more possible the destination can be taken into consideration in decision-making process^[4].

As to the Components of DI, many scholars have strongly identified that DI is an overall image composed of multi-dimensions, but they still have different views on its components^[5].

For example, state that the construction of the DI depends on two evaluations: perceptual/cognitive and affective. The former refers to beliefs or knowledge about

the attributes of a destination, while the latter refers to feelings/attachment to the same^[3]. Echtner and Ritchie^{[6][7][8]} suggested that DI was composed of three dimensions: attributes/holistic, functional/psychological and common/unique DI into four dimensions: natural resources, service quality, entertainment and affective image^[9].

2. Destination Satisfaction (DS)

Satisfaction is perceived to be a key to the success of many organizations^[1]. Academic literature postulates that customer satisfaction is a function of the discrepancy between a consumer's prior expectations and his/her perception regarding the purchase^{[10][11][12][13]}. When satisfaction is discussed in place marketing it is referred to as place satisfaction, and can be defined as a multifaceted judgmental summary of the experience a person has of the physical and social dimensions of a place^[14]. In the context of tourism, DS as the tourist's emotional state after experiencing the trip^[15]. DS can also be used as a measure to evaluate the products and services offered at the destination^{[16][17][18][19]}. Undoubtedly, DS is a multi-dimensional construct^[20]. A case of National park, Lee and Chen^[21] categorized DS into four parts: facility and service, convenience and dining environment, climate and space and landscape and environment. Measures tourist satisfaction with multiple destination attributes and subsequent intention to repeat visitation and recommend to others^[22].

3. Marketing Communication

Marketing communication is a means by which companies try to inform, persuade, and remind consumers directly or indirectly, about products and brands sold. The contribution of marketing communication in shaping brand equity through the marketing communication mix and the basic framework of general communication (advertising, sales promotion, events and experience, public relations and publicity, direct marketing & active marketing, word of mouth, and personal sales) will shape consumer understanding of brand awareness, brand image, brand response and brand relations [23]. Marketing communication aims to achieve the three stages of change shown to consumers. The first step to be achieved from the marketing communication strategy is the stage of knowledge change, in this change the consumer knows the existence of a product, the second stage is the attitude change in the consumer behavior this attitude change is determined by three elements referred to by Sciffman and Kanuk showing that stages of change in attitude are determined and conation (behavior), if these three components indicate a tendency towards a change (cognitive, affective, and conative).

IV. RESEARCH METHODS

This research is a descriptive qualitative study by describing and analyzing existing data based on the theory of Destination Image, Destination Satisfaction, and Marketing Communication. The technique of collecting data uses

primary data namely interviews and FGDs to related informants who are selected purposively in order to meet research needs, while secondary data is using literature study techniques and documentation to confirm and strengthen the data for analysis. Qualitative data analysis requires researchers to carry out activities simultaneously with data collection, data interpretation and writing research reports^[24]. This data analysis is not done separately with data collection, but is an activity carried out together. During data collection, researchers move interactively in 3 components of analysis, namely data reduction, data presentation and final conclusions / verification^[25].

V. RESULT AND DISCUSSION

Due to the development of increasingly rapid information technology, it requires the actors of this sector to develop access to their customers, especially in attracting customers or foreign tourists. The tourism sector provides an important role in growing the economy of a region. In Heritage Indonesia there's Borobudur that have image and satisfaction to tourism attend and visit this temple.

The tourists visiting Borobudur Temple do have a variety of factors or reasons why they chose Borobudur Temple as a tourist destination in Indonesia. Factors that influence people coming to Borobudur include:

1. Destination Image

Tourist knows about Borobudur Temple form temple because ever one of seven a miracle in the world and they know this is a temple from Buddhist culture, the place Buddhist pray. That was a Richo (30th Australia) told about BorobudurTourist know about Borobudur Temple form temple because ever one of seven a miracle in the world and they know this is a temple from Buddhist culture, the place Buddhist pray. That was a Richo (30th Australia) told about Borobudur. Not only that, the beauty of Borobudur is a lure for the increasing awareness of tourists to revisit Borobudur.

"I choose to go here fifty minutes ago, but this is very spectacular and beautiful. We're very impression, the fold temple realize me this temple is beautiful and very amazing. And we got wonderful experience. (Sany, 54th, America)".

Mr. Pertamina (51st -Medan) admitted that he had visited Borobudur five times. Every time to Yogyakarta, he always takes time to visit Borobudur.

"I have been here five times, every time I go to Jogja when it's the same time as my family or there is a trip with friends, I will make a visit here, but obviously the temple is clean and of course here (Mr. Pertamina 51st - Medan) ".

Although it was built in BC, this building stands strong and majestic. This is a feeling of astonishment to visitors who feel that there is no sophisticated technology to build this magnificent temple.

"That's a difficult feeling to express because this temple so beautiful and large and I can't to explain with a words. And definitely come to here is so worth it and I always think how the building so large infrastructure why is not have a technic and technology at the past (Syaif, 45th, Bangladesh)".

Based on the results of the interview above, the image of Borobudur temple as one of the 7 wonders in the beautiful and magnificent world has become a positive image of Borobudur temple and an important factor for tourists to choose Borobudur temple as a tourist destination in Indonesia.

2. Destination Satisfaction

A sense of visitor satisfaction that influences the desire to come back is also supported by the service tourism, hospitality, and security that exist in this Borobudur Temple.

"It's good, and this yard is very nice around the temple. I very like this place, and for me to visit this kind monument it's have a feeling. So impress, quiet, and several people it's very impressive. (Eniq, 57th, French)".

The driver of his own sense of satisfaction is the role of security officers who in addition to providing a sense of security because of the increasing number, security officers also kindly help visitors to find a good spot to capture the moment at Borobudur.

"Several times here, and come here with friends for photo photos. And now there is a real change, for example, like the security guard is newer and more helpful for us to photograph, keep telling us about the good spots where the angle is like that (Tya, 22nd, Bandung). "

In addition to the image of the Borobudur temple, destination satisfaction is also an important factor including comfort and safety when visiting. The comfort in question is the friendliness of the officers in providing services and assistance to the tourists. Besides that, the safety when visiting Borobudur Temple is also an important factor when they will choose Borobudur temple as a tourist destination.

3. Marketing Communications

The existence of marketing communication that aims to inform, persuade, and remind tourists directly or indirectly, about Borobudur Temple through advertising media, sales promotions, events and experiences, public relations and publicity, direct marketing & active marketing, word of mouth, and personal sales will shape consumer understanding of brand awareness, brand image, brand response and brand relations. The existence of effective marketing communication is able to provide knowledge (knowledge), in this change consumers know the existence of a product, the second stage is attitude change in the consumer behavior changes in attitude are determined by three elements referred to by Sciffman and Kanuk shows that conation, if these three components show a tendency towards a change (cognitive, affective, and conative). Thus the presence of marketing communication is very helpful in consumers becoming loyal consumers of the products or services offered.

In Borobudur Temple tourism products based on the results of interviews it turns out that tourists do not know much about Borobudur Temple through Borobudur management. Although as a legacy of miracles as well as the international standard tourist attractions, the management of Borobudur Temple is still lacking. Visitors know more about what they find when searching for travel recommendations by bloggers and vloggers. Tourists visiting Borobudur know

more about Borobudur temple through bloggers and vloggers, not through advertisements with print, electronic and online media created by Borobudur management. Travelers also know more about Borobudur due to the many cultural events held at Borobudur Temple. This is very unfortunate because the management of Borobudur should be able to make advertisements in various media about Borobudur temple which is the 7th world tourism service in Indonesia.

"Never got information about this place, but I ever seen in booklet and magazine witch like Time Magazine tell land of Indonesian. And I ever see this information so easy to have in internet or Youtube. Yaaco, 51st, Netherland)".

For local visitors, they admitted that they had received information about Borobudur, but it was more about dance, music, or 1000 lanterns, but never to publish Borobudur Temple.

"Yes, of course from the lesson, at least if there is a Vesak program, the concert will be like that. Just to see that there are music events, or dance events, the ads are more there, not for Borobudur. The place is in Borobudur but sells other messages. (Muhammad Arif, 27th, Magelang) "

Thus based on the results of research that factors that influence the destination loyalty of tourists choosing Borobudur Temple as a tourist choice in Indonesia are based on destination image, destination satisfaction and marketing communication.

VI. CONCLUSIONS

The destination image of Borobudur besides including the Seven Wonders of the World is also described as a beautiful, majestic destination, and is a relic of Buddhist culture. This image is supported by the service, friendliness and security felt by visitors which encourages a sense of satisfaction to visit Borobudur Temple. Therefore visitors have an interest in returning to visit Borobudur temple based on what they describe and feel. Although in this case the tourists get a lot of information about Borobudur temple not through direct promotions from Borobudur management. They know more from bloggers and vloggers. Thus, massive marketing communication is still needed, for example through advertising, sales promotion, public relations and publicity, direct marketing & active marketing, word of mouth, and personal sales so that Borobudur temple as an international tourist destination in Indonesia can be increased in terms of its number of visitors and becomes loyal destination.

REFERENCE:

- [1] Bosque, I., & Martin, H. (2008). Tourist satisfaction: A cognitive-affective model. *Annals of Tourism Research*, 35(2), 551-573.
- [2] King, C., Chen, N., & Funk, C.D. (2015). Exploring destination image decay: a study of sport tourists' destination image change after event participation. *Journal of Hospitality & Tourism Research*, 39(1), 3-31
- [3] Baloglu, S. & McCleary, K.W. (1999). A model of destination image formation. *Annual of Tourism Research*, 26(1), 868-897
- [4] Chi, G.Q., & Qu, H.L. (2008). Examining the structural relationships of destination image, tourist satisfaction and destination loyalty: An integrated approach. *Tourism Management*, 29(4), 624-636.
- [5] Alcaniz, E.B., Garcia, I.S., & Blas, S.S. (2009). The functional-psychological continuum in the cognitive image of a destination: A confirmatory analysis. *Tourism Management*, 30(1), 715-723
- [6] Echtner, C.M., & Ritchie, J.R.B. (1991). The meaning and measurement of destination image. *Journal of Tourism Studies*, 2(2), 2-12.
- [7] Echtner, C.M., & Ritchie, J.R.B. (1993). The measurement of destination image: an empirical assessment. *Journal of Travel Research*, 31(4), 3-1.
- [8] Echtner, C.M., & Ritchie, J.R.B. (2003). The meaning and measurement of destination image. *Tourism Management*, 14(1), 37-46
- [9] Hernández-Lobato, L, Solis-Radilla, M.M., Moliner-Tena, M.A., & Sánchez-García, J. (2006). Tourism destination image, satisfaction and loyalty: a study in Ixtapa-Zihuatanejo, Mexico. *Tourism Geographies*, 8(4), 343-358
- [10] Churchill Jr., G.A., & Surprenant, C. (1982). An investigation into the determinants of customer satisfaction. *Journal of Marketing Research*, 19(4), 491-504
- [11] Oliver, R.L. (1977). Effect of expectation and disconfirmation on postexposure product evaluation: An alternative interpretation. *Journal of Applied Psychology*, 62(4), 480-486.
- [12] Tse, D.K., & Wilton, P.C. (1988). Models of consumer satisfaction formation: An extension'. *Journal of Marketing Research*, 25(2), 204-212.
- [13] Yi, Y. (1990). A critical review of consumer satisfaction. In V.A. Zeithaml (Ed.), *Review of marketing*, 68-123, Chicago: American Marketing Association.
- [14] Mesch, G., & Manor, O. (1998). Social ties, environmental perception, and local attachment. *Environment and Behavior*, 30(4), 504-519
- [15] Baker, DA., & Crompton, J.L. (2000). Quality, satisfaction and behavioural intentions. *Annals of Tourism Research*, 27(3), 785-804
- [16] Ross, R.L., & Iso-Ahola, S.E. (1991). Sightseeing tourists' motivation and satisfaction. *Annals of Tourism Research*, 18(2), 226-237.
- [17] Noe, F.P., & Uysal, M. (1997). Evaluation of outdoor recreational settings. A problem of measuring user satisfaction. *Journal of Retailing and Consumer Services*, 4(4), 223-230
- [18] Schofield, P. (2000). Evaluating Castlefield urban heritage park from the consumer perspective: destination attribute importance, visitor perception, and satisfaction. *Tourism Analysis*, 5(2-4), 183-189.
- [19] Bramwell, B. (1998). User satisfaction and product development in urban tourism. *Tourism Management*, 19(1), 35-47.
- [20] Tsiros, M., Mittal, V., & Ross, W.T. (2004). The role of attributions in consumer satisfaction: A re-examination. *Journal of Consumer Research*, 31, 476-483.
- [21] Lee, Y.H., & Chen, T.L. (2005). Traveling motivation and satisfaction of tourists: An empirical study of Taroko national park in Taiwan. *The Business Review*, 4, 175-181.
- [22] Kozak, M. (2003) Measuring tourist satisfaction with multiple destination attributes. *Tourism Analysis*, 7, 229-240.
- [23] Kotler, Philip (2009) *Marketing Management*, Edisi 13, Jakarta, Erlangga
- [24] Cresswell, J.W. 2012. *Research Design: Qualitative, Quantitative and Mixed Approaches*. Third Edition. . Yogyakarta: Pustaka Pelajar
- [25] Sutopo, HB, 2006. *Qualitative Research Methodology: Basic Theory and Applied in Research*, Surakarta: Sebelas Maret University Surakarta

The Resistance of Community in Managing Wisdom Tourism

(Case Study: Collaborative Governance Between Villagers and Village Government in Wonokerto Village, Sleman, Yogyakarta)

Muchamad Zaenuri, Helen Dian Fridayani, Khusnul Khotimah

Abstract-The purpose of this study was to find out how the resistance of the community especially in collaboration between Wonokerto Village Government and Pulesari village community in the managing of Pulesari Tourism. The type and method used by researchers in this study are qualitative research with descriptive methods. The subjects in the study were the Pulesari community and the Wonokerto Village government. Data collection techniques conducted by researchers is a qualitative approach in the form of observation, interviews, and documentation. Data analysis is done by examining the results of the reduction, presentation and conclusion. The results of this study are that the collaboration carried out by the Wonokerto village government and the Pulesari community has gone quite well. The Wonokerto Village Government acts as a facilitator in aspects of infrastructure development and human resource empowerment and promoters. Whereas the Pulesari community acts as the manager of Pulesari Tourism Village and the direct tourist of tourism services. The Pulesari community and the Wonokerto Village government have been involved in shared vision and participated in the implementation of tourism services and the development of tourism villages for the benefit of the community of Pulesari. Each party has a commitment to a common purpose and mutual trust among the participants. In addition, each party has also shared responsibility in structuring, managing, implementing and evaluating (distributive accountability), and sharing information can be easily accessed by all parties through social media, web and village communication forums.

Keywords: Collaborative, Governance, Community, Village Government.

BACKGROUND

According to Fandeli (2002: 7), tourism is one of the industries that produces the most foreign exchange for the State, so the government is trying to improve this sector by taking tourism development policy measures. Indonesian tourism destinations are usually aimed at a tourist area or what is called a tourist village. Based on data from the DIY Tourism Office in 2016, tourist villages in DIY reached 122 which were spread among 38 tourist villages in Sleman Regency, 14 tourist villages in Gunung Kidul Regency, 27 tourist villages in Yogyakarta city, 33 tourist villages in Bantul Regency, and 10 villages in Kulon Progo Regency. The theme of a number of tourist villages that have been established in DIY is the village of natural tourism, local culture and crafts.

In the 2018 tourism village festival held by the Government in one of the districts in DIY, Sleman Regency,

Pulesari Tourism Village was chosen to be the best tourist village. Pulesari Tourism Village is located in Wonokerto Village, Turi District, Sleman Regency, Yogyakarta Special Province. This tourist village was formed on May 26, 2012. This village was formed thanks to the commitment of the people who want to create a village that is safe, peaceful, comfortable, dynamic and beautiful with a variety of potential that exists. The awards that have been achieved by Pulesari Tourism Village are: 1) Sleman Regency 2014 and 2018 1st place winners in the framework of Sleman Regency Tourism Village Festival activities, 2) becoming one of the representatives from Yogyakarta who participated in the CBT (Community Based Tourism) Award ASEAN in 2016, 3) was appointed as a pilot project for sustainable tourism development along with four other tourist destinations in Indonesia tasked with preparing Ministerial Regulations in the Development of Sustainable Tourism with guidelines from the UNWTO (United Nation-World Tourism Organization) or World Tourism Organization.

The achievement of Pulesari Tourism Village above is certainly obtained through the role and cooperation of several parties in this case the Pulesari Tourism Village community and Wonokerto Village government. The form of cooperation between the Wonokerto Village government and the Pulesari Tourism Village community is in the form of collaboration. Collaborative governance (Zaenuri, 2018: 39) is a governance that regulates institutions both state and non-state institutions that are directly involved in the process of making joint decisions oriented to consensus and deliberation. Collaborative management is very important because it can make the performance of the bureaucracy better and institutions that implement collaborative management will benefit. To what extent has the collaboration been carried out by the Wonokerto Village Government and the Pulesari Tourism Village community. How is the collaboration between the village community and village government in the management of Pulesari Village in Wonokerto Village.

RESEARCH METHOD

The type of research used in this study is qualitative. According to Sugiyono (2014: 8-9) qualitative research can be interpreted as research conducted on natural conditions and ethnography because it is widely used in

research in cultural anthropology. The method used is descriptive method. The subjects of this study were the Pulesari community and the Wonokerto Village government. The researcher chose the subject because he wanted to see the collaboration carried out by both parties in the development of Pulesari Tourism Village. Data collection techniques used by researchers are observation, interviews, and documentation. Data analysis is done by examining the results of the reduction, presentation and conclusion. After the data is collected, the data is analyzed by analyzing the data reduction results, then the data is presented in written form and conclusions are drawn.

THEORETICAL FRAMEWORK

Collaborative Governance is a model that brings together stakeholders general public and private sector in the collective forum with public institutions to engage in decision making that is a consensus. In other words, Collaborative Governance is Handler arrangement which one or more public agencies and non-state stakeholders directly involved in the decision-making process of formal collective, oriented consensus, deliberatif and aims to create or implement public policy, manage the program or public assets. (Ansell & Gash, 2008). In dealing with the instructing and styling a public problem is needed the involvement of the institution or other non-government agencies including local non-governmental organizations or indigenous institutions and indigenous communities who live in the middle of the community because the problem is not enough public only handled by these units of government institutions both in an integrated or related.

Collaborative Governance is a model that is able to accomodate various interests of stakeholders and non-government organizations so that in practice many used to penyeleseian disputes between stakeholders, community and government (Ansell & Gash, 2008). This collaboration approach is believed as a bridge to improve tourism development. The development of tourism as an area with a variety of resources would involve many parties start from the regional government and the local community, private companies, NGOS, travel agency and the other parties related to the region. Therefore the model of Collaborative Governance saw the participation of all stakeholders in the management activities included in the tourism development planning process. This is considered important because equalities role and the coordination of stakeholders is the key to success in this model of Collaborative Governance.

The concept called governance can basically mean steer or control in classical Latin. This concept basically means actions or perspectives in regulating, guiding, and directing. So, governance is a way or model in running a wheel of government. While government is the institution and institutions that are authorized to run the government (Damanik, Januantin and Weber, 2016). Governance or governance is defined as the overall interaction between the public and private sectors involved in solving community problems and creating social opportunities. A governance must be based on three pillars, namely coordination, collaboration and consultation, then designing integration in resource management as the basis for planning and decision making (Winara, A., & Mukhtar, 2011).

The term collaborative governance is a way of managing government that directly involves parties involved outside the country, consensus-oriented, and deliberation in a collective decision-making process that aims to create and also implement public policies and public programs (Ansell, 2007). The focus on collaborative governance is on public policies and problems. Public institutions do have a large orientation in policy making, the purpose and process of collaboration is to reach a degree of consensus among stakeholders. The concept of collaborative governance requires the realization of social justice in fulfilling public interests (Sambodo, G. T., & Pribadi, 2016). Ansell and Gash explained a new strategy from the government called collaborative governance. Form of governance that involves various stakeholders or stakeholders simultaneously in a forum with government officials to make joint decisions (Ansell, 2007).

In terms of concepts, collaborative governance can be interpreted as a new form of governance that involves all stakeholders in one work through regular dialogue and interaction in pursuit of shared goals (Innes, J.E and Booher, 2004). There are certain characteristics in relationships between stakeholders so it is necessary to conduct collaborative studies (Silvia, 2011). Collaboration is interpreted differently from networks (networks) and partnerships (partnerships). According to (Ansell, 2007) networks are used to describe the form of government cooperation with communities whose scope is more plural, informal and implicit. Partnerships are used to describe cooperation that is more oriented towards coordination than consensus in decision making. Collaboration is used to describe formal, explicit and collectively oriented cooperation in decision making. According to (Zadek, 2006) in realizing collaboration there needs to be stages that show the scale and intensity of collaboration, while partnerships do not show that. The scale can be described as a ladder that shows the level of commitment from the lowest to the highest or the most complicated collaboration.

RESULTS AND DISCUSSION

Pulesari Tourism Village is located in Pulesari Hamlet, Wonokerto Village, Turi District, Sleman Regency, D.I. Yogyakarta Province. In managing the development of Pulesari Tourism Village there are several parties involved. The parties included the Pulesari community and the Wonokerto Village government. The relationship between the two parties can be seen in figure 1 attached.

Shared Vision

Shared vision according to Zaenuri (2018: 192) is the foundation or basis for collaboration. Without shared vision, all collaborative processes cannot work. In Pulesari Tourism Village, the formulation of a shared vision began with the formulation of the problems delivered by the Pulesari community to the management of the tourist village. The formulation of the problem is then sorted out by the manager of the tourist village so that a vision can be formulated and the mission that can be done. After the vision and mission were formulated, the management of the tourism village along with representatives from the Pulesari community participated in a meeting held by the Wonokerto

Village government. In the meeting, the manager of Pulesari Tourism Village and representatives of the Pulesari community conveyed the formulation of the vision and mission in Wonokerto Village. The vision and mission is then adjusted to the vision and mission of Wonokerto Village. All parties have been involved in making a shared vision. The shared vision was formulated based on the opinions of the people which were then discussed together with the village government so that the vision that was built remained in accordance with the vision of Wonokerto Village. The vision that was set still prioritized the welfare aspects of the Pulesari community.

Participation

Participation is an important component in the administration of a government. This also applies in collaborating. Participation according to Juliantara (2002: 87), namely the operation of a system of government where policies are taken must always be through the approval of the people, while for the basic direction to be developed is the empowerment process. In the development of tourist villages there needs to be participation from all parties including the community and the village government. The participation carried out by the Pulesari community and the Wonokerto village government is adjusted to the jobdesk and their respective capacities. The form of participation carried out by the Pulesari community is as the manager of Pulesari Tourism Village and the direct tourist of tourism services. The form of participation carried out by the Wonokerto village government was as a facilitator (physical and non-physical) and a promoter in introducing Pulesari Tourism Village.

There are some people who act as managers of Pulesari Tourism Village and some are acting as tour guides. People who act as tour guides are young people and men who are still able to guide. Whereas men who are unable to guide tourists act as among guests. In addition, mothers and young women have a role in the culinary field. In addition to the participation of the community above, the village government also participated in the holding of tourism villages. The participation of the Wonokerto village government in the development of the Pulesari Tourism Village is in the form of road access and guidance. Pulesari is part of the Wonokerto village area so that the village government supports infrastructure in the form of providing road access to the tourist areas. In addition there are also other forms of participation carried out by the village government, namely by the existence of capacity building. In strengthening capacity, the village government participates in activities related to increasing the human resources of Pulesari Tourism Village managers such as guiding training, homestay, batik and screen printing. The village government also helps provide training in terms of management, promotion, and guides by collaborating with related institutions.

Commitment to a Common Purpose

Goldsmith and Kettl in Irawan (2017: 6) state that Commitment to a Common Purpose is a reason why a network or network must exist because attention and commitment can be important components to achieve positive goals carried out together. These goals are usually

found in the general mission of a government organization. Commitments from various parties related to Pulesari Tourism Village already exist. The Pulesari community and the Wonokerto village government have committed to the welfare of the Pulesari community and advancing the tourism village. To increase commitment, there needs to be honesty from each party / stakeholder.

The thing that encourages the community and village government to commit to developing the Pulesari Tourism Village is the feeling that Pulesari Tourism Village is theirs so they voluntarily participate in the implementation, management, and service of tourist villages. The Pulesari community and the Wonokerto village government have the principle that tourism villages are their assets that can advance their village, of course they will be committed to their management. In addition, the community can increase income from additional sources of income through Pulesari Tourism Village. After the community has benefited financially, the community has become more committed to improving services in tourist villages. The higher the commitment that is built, the more compactness can be seen from all parties in implementing or participating in advancing the tourism village.

Trust Among The Participants

Trust Among The Participants is a professional or social relationship, and the belief that participants entrust information or efforts from stakeholders or other stakeholders in a network to achieve common goals. So that in this case, every stakeholder must trust each other because trust is a manifestation of the professional relationship that has been established to achieve successful implementation of collaborative governance (Goldsmith and Kettl in Irawan, 2017: 6).

The process of forming trust between stakeholders is a requirement in building solid collaboration between stakeholders. Trust here can be interpreted as individual beliefs towards other individuals and groups one with another group. Trust is also based on the belief that the parties will be honest in the agreement and comply with their commitments and will not exploit the other party. The form of trust seen between the community and the Wonokerto village government is in the form of good relations created and all parties can carry out their duties and responsibilities without any suspicion. In addition, all parties have also agreed to a joint agreement so that trust between parties does not decrease. Village meetings are held once a year. This activity aims to see how forms of management, management, and implementation are carried out in the previous year. The meeting was also used to discuss what was needed to develop tourism villages in Wonokerto.

Sharing Information

DeSeve's sharing of information in Lukito (2016: 8) is an easy access for members, in which there is privacy protection, and limited access for non-members as long as it can be accepted by all parties. In collaborative governance there must be clear information sharing. In addition, in collaborative governance there is a need to facilitate access to information for each stakeholder.

The sharing of information carried out by the Pulesari community and the Wonokerto Village government is in the form of promotion using IT (social media and the web). This promotion is important so that Pulesari tourism will become more widely known by the public. Promotions that have been disseminated through the web can be seen on the website: <https://desawisatapulesari.wordpress.com>.

The website above is the official website that is used to provide information while promoting tourism in Pulesari Tourism Village. The information on the web includes the latest information about Pulesari Tourism Village, profile, vision and mission, foundation (legal rules), tourist attractions offered, tourist facilities, tour packages, salak museums, reservations, and galleries. In addition to the web, promotions are also carried out through social media. One of them is via YouTube.

Youtube is one of the media considered quite helpful in promoting Pulesari Tourism Village. There are several videos that can easily be accessed via youtube related to Pulesari Tourism Village. The videos include videos that introduce the tourist village of Pulesari, TVRI program with Pulesari Tourism Village and some documentation videos outbound from several tourists who have visited. At present everyone has access to information about Pulesari Tourism Village. However, not all elderly people who become tourism service providers understand about IT. So that there needs to be further communication in order to avoid misunderstandings in the delivery of information. The solution that can be used to overcome the obstacles or problems above is to share information in meetings or meetings held either through meetings or hamlet meetings (village communication forums) conducted every month.

CONCLUSION

The collaboration carried out by the Wonokerto village government and the Pulesari community has gone quite well. Collaboration seen in shared vision, participation, commitment to a common purpose, trust among the participants, distributive accountability or accountability, and sharing information has gone well and prioritizes the welfare of the community. All parties (Pulesari community and Wonokerto village government) have been involved in making a shared vision formulated based on community opinion and adapted to the vision of Wonokerto Village. In the collaboration carried out, the Wonokerto Village government participated as a facilitator in aspects of infrastructure development and HR empowerment and promoters. While the Pulesari community participated as managers of Pulesari Tourism Village and direct tourism services. The Pulesari community and the Wonokerto village government have committed to the welfare of the Pulesari community and advancing the tourism village. The form of trust seen between the community and the Wonokerto village

government is in the form of good relations created and all parties can carry out their duties and responsibilities without any suspicion. Distributive Accountability or Responsibility has gone quite well where there is a clear division of responsibilities for each party according to its capacity. In addition, all parties are involved in making policy decisions ranging from structuring, management, implementation to evaluations carried out through village meetings. Finally, the sharing information that is done is very good. The distribution of information carried out by the Pulesari community and the Wonokerto Village government is in the form of promotions using IT (social and web media) and village consultations or communication forums.

REFERENCES

- Dinas Pariwisata Daerah Istimewa Yogyakarta. (2014). *Laporan Akhir Kajian Pengembangan Desa Wisata Di DIY*.
- Fandeli, Chafid. (2002). *Perencanaan Pariwisata Alam*. Yogyakarta: Universitas Gadjah Mada.
- Hartina. (2017). *Smart Governance (Studi Kasus Pada Pelayanan Pendidikan Dasar dan Menengah di Kabupaten Bone)*. Laporan Penelitian. Makassar: Universitas Hasanudin.
- Irawan, Denny. (2017). *COLLABORATIVE GOVERNANCE (Studi Deskriptif Proses Pemerintahan Kolaboratif Dalam Pengendalian Pencemaran Udara di Kota Surabaya)*. Jurnal Kebijakan dan Manajemen Publik. Vol. 5, No. 3. Hlm. 1-12.
- Juliantara, Dadang. (2002). *Pembaruan Desa : Bertumpu Pada Apa Yang Terbawa*. Yogyakarta : Lapera Pustaka Utama
- Lukito, & Haryanto, Aris Tri. (2016). *COLLABORATIVE GOVERNANCE DALAM PENGEMBANGAN KERAJINAN BLANGKON DI KECAMATAN SERENGAN KOTA SURAKARTA*. Jurnal UNISRI. Vol. 3, No. 1. Hlm. 1-16.
- Pengelola Desa Wisata Pulesari. (2018). *Dokumentasi Bentuk Pelatihan SDM di Dusun Pulesari*. Tidak Diterbitkan.
- Putri, Hemas Prabawati Jakti., & Manaf, Asnawi. (2013). *Faktor-Faktor Keberhasilan Pengembangan Desa Wisata di Dataran Tinggi Dieng*. Jurnal Teknik PWK UNDIP. Vol. 2, No. 3. Hlm. 559-568.
- Raharja, Sam'un Jaja. (2008). *Model kolaborasi dalam pengelolaan Daerah Aliran Sungai Citarum, Disertasi Program Doktor Ilmu Administrasi Publik*. Depok: Universitas Indonesia.
- Sastrayuda, Gumelar. (2010). *Konsep Pengembangan Kawasan Ekowisata*. Yogyakarta: Universitas Pendidikan Indonesia.
- Sugiyono. (2014). *Metode Penelitian Kuantitatif, Kualitatif dan R & D*. Bandung : Alfabeta.
- Zaenuri, Muchamad. (2018). *Tata Kelola Pariwisata-Bencana Berbasis Collaborative Governance; Konsep, Analisis dan Pemodelan*. Yogyakarta: Explore.
- <https://desawisatapulesari.wordpress.com>
<https://m.youtube.com/watch?v=P0wcSI6xyTk>

Fragmented Politics: A Case of Muhammadiyah Elites in the Presidential Elections in Indonesia

David Efendi

Universitas Muhammadiyah
Yogyakarta

Corresponding author:
defendi@umy.ac.id

Husni Amriyanto Putra

Universitas Muhammadiyah

Yogyakarta

choenny@yahoo.com

Alhafiz Atsari

Universitas Muhammadiyah
Yogyakarta

Abstract– Presidential elections as the political sites among people especially elites of mass organization have been playing a very crucial role in shaping and reshaping formal politics in Indonesia since 1998 up to now. The public expectation might be too high to demand for more democratic state and participatory policy at the event of electoral politics. However, a lot of cases about the unconsolidated picture between elites and its followers (voters). The worst things even had happened namely an elite fragmentation in term of political affiliation and strategy—and it had ended in the several failures in supporting presidential candidates. By employing series of interviews, Focus Group Discussion, and analyzing media, this research firstly finds that the electoral politics of Muhammadiyah is considered as ‘unconstitutional’ or ‘anti-khittoh’ in which this situation become political hindrance in time. Secondly, the organizational design is not compatible with the practice politics, and lastly the autonomy of the organization wings in Muhammadiyah contributes to the problem of consolidation between elites and members.

Keywords: Presidential Election, Elite, Muhammadiyah, Political Fragmentation, Civil Society.

A. INTRODUCTION

“Please make distinction there is political fragmentation, but it needs to be united by the national strategic issues.” (Din Syamsuddin)¹²

“Muhammadiyah was relaxed in facing 2009’s election. Tanwir, the highest consensus after general assembly, will not discuss general election because we will focus on strengthening internal organization and encouraging vision and national character as well as more emphasizing on morality aspect.” (Haedar Nashir)¹³

The two quotes above are the ones of fundamental illustrations for demonstrating how Muhammadiyah’s elites

“always” witness different perspective in responding to political dynamics which later reinforce the idea fragmentation in Muhammadiyah consisting of political and non-political groups, and also structural and cultural groups later manifesting in Islam political and cultural context even more complicated in which it is revealed by considering very heterogeneous dimension in Muhammadiyah consisting of structure, autonomous organization, political circumstances, and distinct history. It is not simple because in Islamic thought it is also fragmented into conservative-fundamentalist group and liberal-progressive groups (Boy, 2008)¹⁴. Although there are many factions in Muhammadiyah, according to Kim Hyung-Jun (2010) Muhammadiyah could cover myriad of contention groups.¹⁵ Nonetheless, the authors suspect many challenges emerge beyond fragmentation of political elite by considering the latest political context both national and local which is not symmetric in Indonesia.

The depiction of the diversity of Muhammadiyah’s political elite perspectives is not novel phenomenon in which Afan Gaffar, as UGM’s Political Science Professor, who has double position as the member of council of Muhammadiyah has ever conveyed controversial statement about the type of Muhammadiyah elites consisting of three groups such as elite earning money from Muhammadiyah, elite seeking legitimacy, and elites sincere.¹⁶ Later, other types of Muhammadiyah emerge such as Muhammadiyah’s politician and Muhammadiyah’s ideologue who are against groups attempting to involve Muhammadiyah in political practice. The phenomenon possesses long history in traditional elite metamorphosis into modern elite which race in power and defense.¹⁷

Despite Muhammadiyah affirms that it is not involve politics, Muhammadiyah’s elites continuously interact with politics and involve Muhammadiyah in politics since its founder. Ahmad Dahlan was a political

¹² Din Syamsuddin, Former Chairman of Muhammadiyah from 2005-2010 about the necessity of Islamic parties coalition, Sinar Harapan, 12 Desember 2008 republished on Tempo magazine on 5 April 2009.

¹³ Haedar Nashir, Chairman of Muhammadiyah, published on official website of Muhammadiyah www.muhammadiyah.or.id, Monday, 2 March 2009.

¹⁴ Thesis of Pradana Boy ZTF at ANU entitled ‘In Defence of Pure Islam: The Conservative-Progressive Debate within Muhammadiyah’, Boy firmly and bravely illustrated that there was competition between conservative and progressive group in Muhammadiyah.

¹⁵ Reseacher from Kangwon University, Kim Hyung-jun said, Muhammadiyah is a unique organization. His research witnessed that

Muhammadiyah can cover contention perspectives. Muhammadiyah has myriad of advantages, but it never show them up. It might happened because of Ahmad Dahlan’s influence, which is known with his philosophy ‘talk less, do more.’ Published by Kompas, 16 Mei 2010 and Muhammadiyah.or.id

http://www.muhammadiyah.or.id/index.php?option=com_content&task=view&id=1990&Itemid=2

¹⁶ Article of Muhammadiyah Siap Kongres di Aceh’, on interview with Din Syamsuddin and Afan Gaffar on Gatra magazine on 1 July 1995

¹⁷ When power is not suspected as zero sum game, but it is distributed (Weberian).

party member of Masyumi and Parmusi in Old Order regime as well as PAN and PMB for supporting president candidate. The manner had been suspected by G.H. Bousquet, a French orientalist, "Indeed, it is true that Muhammadiyah is not involved in politics, but its members are involved." 18

This study is aimed to objectively explain how Muhammadiyah's elites deal with electoral politics in Indonesia especially in presidential election. The failure of 2004's politics did not lead to Muhammadiyah's elite to make maneuver in 2009 election even though it emerged anti-practice politics group strengthened after the defeat of Amin Rais.¹⁹ Several arguments emerge about the significance of the research; first, the myriad of basic questions about optimism of civil society organization (CSO) to create democracy. However, some CSOs such as Nahdatul Ulama (NU) and Muhammadiyah always failed in supporting their candidate in direct election for shaping better regime. It is not recognized whether the elites have indeed lost charisma or the organization machine has been paralyzed by political liberalism spirit introduced by parties, successful team, and manifest financier in power behind electoral democracy. Another question here is whether the groups of Islamic political fragmentation confuse their followers. These are fundamental questions in this research.

Secondly, in 2009 and 2014 elections, author observed how strong the fragmentations were seen among old and new Muhammadiyah's elites after 2005 general assembly, or among elite claiming as pure, ideologue, and puritan elites versus pro-political practice. The term of high politics later extends to be used and negated with various interpretations which legitimate or abrogate elite maneuvers. It is a significant contribution in elite studies since elite leadership studies in CSO are rarely conducted by comparing political elite studies in the terms of ruling elite.²⁰ Author desire to prove that political history is history of power. It is a history of few people which is later called ruling elite. So, the history of power, on the other hand is the history of bourgeoisie²¹ which is in Marxian's interpretation it is connected in the industrial-capitalist society boundary.²² For gaining power, many ways are organized such as violence or based on Weber, Bourdieu, and Geertz interpretation utilizes modality of symbol, religion, social capital, economy, and so on.

Thomas Carlyle noted that history is the life journey of aristocrat, thus it can be conveyed that Muhammadiyah's elites are actors involved. In political

power. Along civilization history, only few aristocrats we know. In Islamic history it is noted as Muhammad struggle, and in Catholic history it is known by church elites in Rome-Italy.²³ In Muhammadiyah context, it is very possible that power paradigm is expected in distinct perspectives by elites. Muhammadiyah is a middle class society positioned by various elite groups with diverse interests. Economic elite group is theoretically interested in seeking advantage in political changes.

Thought that CSO is never excluded from political contention called election process is true and factual. Even in some organizations, they abruptly convey political statement before election event including in Muhammadiyah. One of Muhammadiyah's important documents was arranged by Denpasar assembly (Tanwir Denpasar) in 2002 resulting in manifestation in political manner stated read as follows:

"The role in the life of nation and state can be organized through two strategies. First, it is through political activity orientating on power struggle (real politics) as organized as political parties or formal political powers in national level. Second, it is through community activities that are community development or empowerment or indirect political activities (high politics) influencing the state's policies with moral force in order to realize a better life at the community and state level as carried out by interest groups." 24

Muhammadiyah believes that acting in the life of the nation is one manifestation of mission and function of carrying out goodness and avoiding amorality as it has been a historical calling since the era of movement until the early and after Indonesian independence. The role of the nation is manifested in strategic and tactical steps in accordance with personality, belief, and ideal of life, as well as the nature of its struggle as a reference for the movement as a form of commitment and responsibility in realizing better nation (in Arabic terms: *Baldatun Thoyyibatun Wa Rabbun Ghafur*). Moreover, Haedar Nashir argues same perspective that the role of Muhammadiyah can be carried out without directly engaging in power politics (political parties) because non-political paths are still wide open.²⁵

It is one of fundamental reasons why Muhammadiyah dares to struggle for winning Amien Rais as a presidential candidate in 2004 election. The decision of the organization was interpreted to be a lot of understanding by Muhammadiyah followers. Some have responded

18 Ahmad Syafii Maarif on article of 'Potret Politik Muhammadiyah' in the introduction of Syarifudin Jurdi's book entitled, Muhammadiyah dalam Dinamika Politik 1966-2006 (Yogyakarta: Pustaka Pelajar, 2010). Page, vii.

19 Dawam Raharjo, Muhammadiyah dalam Kubangan Krisis, 2010, unpublished paper.

20 Society is divided into two classes such as upper and lower elites. Elite is divided into ruling and powerless elites. Read TB. Bottomore in the book of Elite dan Masyarakat (Jakarta: Akbar Tanjung Institute, 2005)

21 Terms of bourgeoisie.

22 In Weber interpretation, there are three society stages such as traditional society, pre-industrialist and industrial-capitalist society. Industrial-capitalist society is characterized by rational thought, individualist, financial power, and competition.

23 Further example in international political competition, we are familiar with two men contradict to each other? such as George W. Bush and Saddam Husein as two actors triggering war and leading to world economy shutdown as well as genocide, as if they determine massacre event. It is called as history of war, peace and power by a few elites.

24 Source: official news of Muhammadiyah, final court of the 2002 Muhammadiyah Tanwir in Denpasar-Bali. Tanwir is the highest consensus under Mukhtar and on region and branch consensus.

25 High politics does not become political party or part of it, while low politics is suspected as political practice. Definition of high politics is variously interpreted in Muhammadiyah followers. Haedar Nashir in seminar paper, "Khittah Muhammadiyah dan peran politik di Indonesia", on 22 April 2009.

sarcastically about the political formulation in legitimizing the actions of Muhammadiyah elite on the political stage.

As one of members who had been active in Muhammadiyah, I was disturbed by the myriad of speculations about the failure of Muhammadiyah politics in the political arena, including two elections, the 2004 election. Muhammadiyah encouraged its best cadre for better nation, Amien Rais, who eventually failed in the first election step, and the second also failed in 2009 election which was supposedly Muhammadiyah elite symbolically supported two pairs of presidential candidates, Megawati and Jusuf Kalla-Wiranto. In this case, it is simple to observe because it only consists of three pairs of candidate while Muhammadiyah central leader, Din Syamsuddin, maneuvered by inviting two pairs of candidate in which it can automatically be called political origin not SBY. One of absorbing views is that the configuration of political fragmentation of Muhammadiyah is feared by certain groups to have a serious impact on the success of local political elites. Furthermore, Muhammadiyah's elit maneuvers at the national level are not without consequences for the elite in local arena.

Moreover, there are two prominent reasons in this research. First, there has not been a detailed explanation for political failure of Muhammadiyah because in the socio-economic realm it is more successful. During this time the explanation is stopped at the argument that it was natural that Muhammadiyah failed in the political endeavor because the political world was not its habitat. Meanwhile, they claim that Muhammadiyah is not solid, in which there is no clear command unit (collective-collegial), or in another exception Muhammadiyah has no bargaining position in media level where at grassroots level Muhammadiyah is led by elites possessing various loyalty either party or certain patronage. In addition, there is argument that Muhammadiyah has no formulation or design to take part in political power. Even on the contrary Muhammadiyah in certain ways prohibit followers from engaging in practical politics²⁶ in which it can be observed from a number of decrees from PP Muhammadiyah and discourse emerging in the span of 2008-2014.

Secondly, this study has an opportunity to correct and to contextualize elite theory in developing country and Islamic civilization. Indonesia as a new liberal democracy, for example, as a democracy state in Huntington's terminology, influence the elites as well as political transformation in the circumstance very dynamically. The definition of an elite, and the legitimacy of elite power may be partially obsolete, and thus it is replaced by an entirely new type of modality being the foundation of action. The collapse of political elite may not only begin with the collapse of the flow of politics minus that charismatic leadership because the elites are not consolidated and their

modalities or indeed the distribution of power in the body of a religious-based mass organization is very even and not centralized so this fragmentation has an impact on the form of its political response which does not always have a negative connotation.²⁷

Several reasons for choosing a case study as a method in this study include; firstly, the authors claim that in Indonesia there has not been much research on communication within CSOs to win presidential candidates in election. Secondly, the authors desire to obtain a thorough understanding of the challenges, and thus it and thus it can distinguish between speculative opinions and the ones which have basis of argument regarding elite survival in Muhammadiyah politics in the 2009 presidential election. Thus, this research discusses more about how and what factors that lead to the political fragmentation of the Muhammadiyah elite in the presidential election.

B. MUHAMMADIYAH'S ELITE STUDIES

A conceptual framework that is fundamental to note is who the elites is who is the elite? In this context who actually Muhammadiyah elite is? It is immensely crucial in creating understanding in the analysis framework in this research so it is as not to result in excessive generalization.

Firstly, Mas'ood and Mc Andrews (2001) highlight a very significant explanation in the introduction of Robert D. Putnam's paper on elites. Putnam after conducting a long enough study of elite theories then defines oval understandings of political elite, power and political influence. Furthermore, Putnam criticizes the classical social stratification dichotomy dividing into two types, namely the owner's power elite and the masses holding no power.²⁸ Meanwhile Putnam reveals three ways to find out who has the greatest influence or power in a political society, namely by utilizing position analysis, reputation analysis, and decision analysis. All of the three according to Mas'ood have advantages and drawbacks. Nonetheless, according to the definition of power, Putnam recommends decision analysis.²⁹

In the terminology in the Dictionary of Sociology written by David Jary and Julia Jary it is briefly explained that:

Elite is literally the "best" or most talented members of society (e.g. an educational elite), however, in sociology the term most usually refers to political elite. Here, the assumptions of elite theory have been that a division between elites and masses is an inevitable feature of any complex modern society, and that aspirations of radical democrats that the people as whole could rule are mistaken.³⁰

Similar definitions have also been tracked by T. B. Bottomore, and was used in the 17th century to depict goods of perfect quality. The use was later extended to refer to

26 Competition between cultural and structural group benefits from organization legitimacy. In the 2004 election, there was Denpasar decree for supporting Amien Rais and Muhammadiyah legislative candidates. In the 2009 election, there was instruction to protect the unity of Muhammadiyah (read Thesis attachment).

27

28 Classical definition is noted by Gaetano Mosca, Vilfredo Pareto, TB Bottomore, Róbert Mihels, Dorso, Dahl, et al. Meanwhile, there are sic elite

groups regarding in Putnam's pyramid begun with the highest; group of decision making, influential group, activists, political society, voter, non-partisan. Read, Mohtar Mas'ood and Collin MsAndrews in *Perbandingan Sistem Politik*, (Yogyakarta: Gadjah Mada University Press, 2001), page.76

29 Op., Cit, 76

30 David Jery and Julia Jery, *Collins dictionary of Sociology*, (British: herper Collins Publishers, 1991), page.188.

social groups, such as first-class military units or high aristocrats. The Oxford English Dictionary (1823), then categorizes “elite” that refers to the existence of social groups.³¹ Meanwhile, Soerjono Soekanto limits the notion of the elite as:

“Groups of societies who are in certain social situations occupy the highest positions, are considered to have great power and privileges, and are sometimes interpreted as ruling aristocratic groups because of hereditary factors. It is often also interpreted as positions in a relatively high social structure, and thus those occupying positions also have a high position.”³²

Elite is always a group limited qualitatively and is very prominent in roles at the top level. Elite, in this research context, is the religious and intellectual of structural elite at the central level of Muhammadiyah. In Muhammadiyah, leadership is held by 13 people from diverse background.

Scientists studying and terrorizing elite concepts include Pareto, Mosca, Michels, and Darso concurring that wherever and whenever society is always led by a group of small individual power. Moreover, Pareto comprehends between elites in political power or ruling class and powerless elite of top positions in society while Suzanna Keller defines that in the level of influence and impact resulted in by elites, thus they can survive. Meanwhile, Haryanto (1990) reveals that elite always refers to a person or group possessing certain advantages, where elite can carry out influential roles in certain way of life.³³

The habit of social grouping in society based on certain categories has indeed become an inseparable part of mind construction of the community. In addition, elite is a bourgeoisie controlling the economy, and thus the most appropriate designation in the industrial countries is the bourgeoisie as the owner of capital.³⁴

To observe the elite in Muhammadiyah is immensely appropriate to utilize the definition of an elite defined by J.W. School:

“what is meant by the elite is the position in society at the top of the most fundamental social structures, namely high positions in the economy, government, military, politics, religion, teaching, and free work.”³⁵

In the context of Muhammadiyah, the specific definition of elite is closer to what is referred to as “a group or class of persons or members of a group or class, enjoying superior intellectual, social, or economic status.” In addition to notions of social equality there is much emphasis on

the role of elites and of heroes within them” (Times Literary Supplement).³⁶ It is because in the Muhammadiyah, besides the elites in the leadership at the central level, there is also a cultural strength of charisma attached to a particular figure at the national or local level as well as being elite in university leadership or educational institutions as mentioned by School. Moreover, elite mobility is very much determined by the background or achievement of educational height. It can be proved by how many professors can become general chairman of thirteen ‘gods’ of Muhammadiyah.

Another key concept is the challenge of definition of fragmentation. In political theory, the terminology of factionalism, social differentiation, stratification, plurality rather than fragmentation is more popular. Azra (2010) illustrates that political or elite fragmentation is often close to contestation and conflict in a country like Indonesia in recent years.³⁷ To define the term of fragmentation, the authors decide in limiting the definition to other terms that fragmentation is diversity and division in either manifest or latent form in mind, ideology, and political affiliation. The Encarta dictionary, for example, highlights fragmentation as the loss of unity and cohesion and the breakup of something into isolated and often conflicting elements.³⁸ It can be interpreted as a condition that does not coalesce or lose coherence with one another. In the Princeton Dictionary, the term of fragmentation is defined as the disintegration of social norms governing behavior and thought and social relationships. Meanwhile, fragmented means a state called; having been divided; having the unity destroyed.³⁹ To reveal the meaning of fragmentation in the media it often utilizes sentence structure such as: political party fragmentation, legal fragmentation, and movement fragmentation in which to contrast with the word unity, integration, homogeneity, uniformity, and wholeness. That is the interpretation of fragmentation that will be conveyed in the concept of this research.

Fragmentation is an expression of factionalism even though it is a distinct term since fragmentation is spontaneous and temporary, whereas factionalism lasts longer. Furthermore, fragmentation can lead to factionalism applying even to non-political organizations. To clarify the definition, it is necessary to observe the factionalism concept utilized widely in the study of political parties. In Muhammadiyah fragmentation is highlighted in autonomous organizations, ideology, perspectives and political thinking, and the latter is polarization and fragmented support for presidential candidates in the 2009 election.⁴⁰

Factionalism etymologically described in the new Encyclopedia Dictionary by Weber has two meanings to the

31 T.B. Bottomore, *Elite dan Masyarakat* (Jakarta: Akbar Tanjung Institute, 2006), page.iii.

32 *Kumpulan Istilah-istilah sosiologi*, Jakarta: Universitas Indonesia, Fakultas Ilmu-ilmu sosial, 1977, page.51

33 Haryanto, *Elit, Massa dan Konflik*, Pusat antar Universitas-Studi Sosial, UGM Yogyakarta, 1990, page.6

34 The definition noted by Mills is people possessing stance on economy, military, and politic shaping an integrated political power that important decisions determine base structure and purpose of public. Furthermore, Mills highlights that elite is not a closed and static group with a set of integrated decisions.

35 J.W.School. Op.Cit. further information in Haryanto.Ibid.page.68

36 <http://www.answers.com/topic/elite>

37 Azumardi Azra, Resonansi, *Demokrasi Revisited*, Republika, 9 Juni 2010

38 Microsoft® Encarta® Reference Library 2005. © 1993-2004 Microsoft Corporation. All rights reserved

39 www.wordnetweb.princeton.edu/perl/webwn

40 Factionalism is defined as a struggle of group to gain power, whereas faction is group of people particularly in political party who often debate for their interests. Source: B.N. Marbun S.H, *Kamus politik*, Jakarta: Pustaka Sinar Harapan, 2002, page.162)

word “faction”⁴¹. First, it is group or combination cooperating and generally towards a larger party (as in a state, political party or church). The second meaning, it is as a dispute in a group (Latin – faction’ making action from the Facere word ‘makes or do’).

According to Harold Lasswell in a book entitled Encyclopedia of Political Science, factionalism from the point of view of political science is defined:

“The term faction is generally utilized for considering the constituent group of a larger unit employing for individual progress or specific policies. This faction appears in an attempt to power and represents a division of application details and not principles.”⁴²

Lasswell notes that factions are actions of a group of society cooperating in order to advance policies and personalities in a larger unit like in a country or interest group. On the one hand, Zariski defines factionalism in internal political parties as follows:

“Faction is synonymous with ‘any combination of party or group possessing members who have a sense of general identity and purpose organized to act collectively as a different part in the party in achieving the expected goals.”⁴³

Noting the definitions by Zariski, Beller, and Belloni it can be concluded that faction is in the internal grouping of political party⁴⁴ characterized among others; first, it exists for a certain period of time, has a minimum organization, demonstrates a general group awareness, actively conveys political, policy, personal, and specific objectives of groups within a party, and lastly can be illustrated as a part in the party.⁴⁵

Not many studies of Muhammadiyah elite have been linked to political actions in the electoral democracy event. In the study of Muhammadiyah, elite is regularly grasped as religious and economic elite that can sustain humanitarian social work. To comprehend this, the authors utilize Bourdie’s, Putnam’s modality and elite theory assisting sufficiently the analysis.

The social capital theory introduced by Boudeu and Putnam is intended to assist in illustrating the political actions of Muhammadiyah elite by relying on the availability and absence of three capitals. First, it is the availability of social capital. According to Putnam, social capital refers to the frameworks of social organizations such as networking, norms, and mutual trusts enabling mutually beneficial coordination and cooperation (1993, 1995). Another definition, social capital is grasped as a concept

with various interrelated definitions based on social value of social networks (Portes, 1998: 1).⁴⁶ In addition, the concept underlying social capital has long been emerged in which philosophers emphasizing the tie between pluralistic community life and democracy include James Madison (The Federalist), Alexis de Tocqueville (Democracy in America), and myriad of other philosophers in the pluralist tradition that are dominant in American political science.⁴⁷

This table assists in mapping the elite modalities of Muhammadiyah in which these modalities are organized by individual elites to legitimize their political maneuvers.

Type of Capital	Capital Coverage; includes
<i>social capital</i>	Networking (national and international) Statue in society (education, religion, and so on) Descent (the nobility, ruler) Strength influence in society A large and respectable organization committee
<i>political capital</i>	Political position Experience in organizing society Descent (the nobility, ruler) Strength in public decision making Reputation and legitimacy
<i>economical capital</i>	Wealth (financial, material) Descent (the nobility, ruler) Strength influence in society Islamic middle class Bureaucrat
<i>cultural capital</i>	Education degree (high) Image and symbol of religion Appreciation of art / culture / cultural preaching

The modalities above are possessed by the elite and only the quality and intensity distinguishing elite from one another. There are several papers that have observed about the theme of communication seen from various political perspectives, elite theory, media, and discourses in the political transition repertoire in Indonesia that the authors consider relevant to be used as a theoretical framework and reference material for writing the same topic even in broader context or more specific.

Nakamura (1983) observes the development of Muhammadiyah in an anthropological perspective focusing attention on the local circumstances faced by Muhammadiyah in Kotagede, Yogyakarta. Nakamura attempts to prove that Muhammadiyah represents a process of religious change taking place due to interaction between various internal elements of Javanese society. Moreover,

youth association can act as a faction if the group witness the characteristics aforementioned above (particularly in reaching political aims).

⁴⁶ Various aspects from the concept have been discussed by all social science disciplines in which some observed the use in the modern era as Jane Jacobs did in 1960s. The first thorough explanation was conveyed by Pierre Bourdieu in 1972. Meanwhile, James Coleman noted definition of Glenn Loury in 1977. Another well-known concept was OECD that social capital, "... as “networks together with shared norms, values and understandings that facilitate co-operation within or among groups.”

⁴¹ Webster’s New Encyclopedic Dictionary. New Revised Edition, Cologne: Köhnmann, 1996

⁴² Noted in Muller-Rommel *Innerparteiliche Gruppierungen in der SDP*. Opladen Westdeutscher Verlag. 1982

⁴³ Zariski, Raphael : *Party Factions and Comparative Politics: Some Preliminary Observations*,

in: *Midwest Journal of Political Science*, 1960.

⁴⁴ Noted in Patrick Kollner and Matthias Basedau, *Factionalism in Political Parties: An Analytical Framework For Comparative Studies*, German Overseas Institute (DUI), Hamburg, 2005.

⁴⁵ Informal character of internal party classification is a rule but it is not always as a faction point. These groups mentioned in political parties like

Muhammadiyah is suspected from the beginning not as the pattern of political movement. However, critically there are various agenda intersecting with politics. In addition, contemporary study conducted by Jurdi (2008) on Muhammadiyah is written as thick as 520 pages with a wide time and spectrum limit of 1966-2006. Unfortunately, the authors have not specifically found the study for the elite to make efforts for survival of the fittest in the political stage which ends in the economic stage.⁴⁸

Table 2.2 Muhammadiyah Studies

Title	Author	Conclusion	Deficiency
Muhammadiyah The Political Behaviour Of a Muslim Modernist Organization Under Dutch Colonialism	Alfian (1989)	There are three types of Muhammadiyah as reformist movement of Islam in Indonesia, namely as a religious reformist, agent of changes dan a political force. ⁴⁹	The locality dimension is stronger rather than general elite which is colonial setting.
Menggugat Muhammadiyah	Abdul Munir Mulkhan	Muhammadiyah must thoroughly criticize it including in terms of observing perception about the tie between Muhammadiyah and political parties. Santri, as Islamic political actor term, is the main point of discussion.	
The Crescent Aries Over the Banyan Three: A Study of the Muhammadiyah Movement in a Central Javanese Town (1976)	Mitsuo Nakamura, 50	Muhammadiyah is multi-colored in a neutral sense. A modernist Islamic organization or movement that cannot be seen from one side with one approach but requires a holistic approach.	Locality

Muhammadiyah dalam Dinamika Politik Indonesia 1966-2006	Syarifudin Jurdi	The most comprehensive study of Muhammadiyah a political dynamics as well as power and political aspects. ⁵¹	Lack of space to witness the political role of the future of Muhammadiyah by reflecting on the 2009 election.
Elit Muhammadiyah & kekuasaan politik	Syarifuddin Jurdi	How the local Muhammadiyah elite specifically in Bima, East Nusa Tenggara on the political stage in the reform era with the condition of regional autonomy and freedom a new round of democracy in Indonesia is. ⁵²	This research is an important frame for seeing the Muhammadiyah elite at a higher level as the authors will observe.
Muhammadiyah, Islam dan Runtuhnya Orde Baru (Studi Tentang Perubahan Perilaku Politik Muhammadiyah Periode 1995-1998).	Suwarno ⁵³ (2000),	Muhammadiyah's internal dynamics were strongly influenced by the appearance of Amien Rais as the Muhammadiyah elite marking the change of leadership in Muhammadiyah from preacher leadership to scholars, and leading Muhammadiyah to be more politically oriented vis a vis the government. In addition, Amien Rais introduced Muhammadiyah to a cooperative attitude, but it was very critical of the abuse of power of New Order regime.	

From some of the literatures above, the authors have not found a specific research on organizational communication in Muhammadiyah by involving central actors both at national and at local levels by observing the challenge of fragmentation in the elite structure regarding

48 Syarifudin Jurdi, *Muhammadiyah dalam Dinamika Politik 1966-2006*, (Yogyakarta, Pustaka Pelajar, 2010).

49 Alfian. *Muhammadiyah The Political Behaviour Of a Muslim Modernist Organization Under Dutch Colonialism* (Yogyakarta: Gadjah Mada University Press, 1989)

50 Mitsuo Nakamura, *The Crescent Aries Over the Banyan Three: A Study of the Muhammadiyah Movement in a Central Javanese Town*. Alih Bahasa Oleh Yusron Asrofi (Yogyakarta: Gadjahmada University Press, 1983)

51 This book included active involvement aspects of Muhammadiyah in political process. As a result of research, the book is categorized as

historical and conceptual about Muhammadiyah involvement in Indonesia politics in authoritarian age (1996-1998) and New Order regime (1998-2006).

52 Syarifudin Jurdi, (2004), *Elite Muhammadiyah dan kekuasaan Politik, Studi tentang tingkah laku Politik Elite Lokal Muhammadiyah sesudah Orde Baru*, Yogyakarta Gadjah Mada University Press.

53 Suwarno, *Muhammadiyah Sebagai Oposisi* (Yogyakarta: UII Press, 2001)

religious attitudes and thoughts as well as politics. This encourages authors to examine more deeply how the elite configuration in political communication is carried out in an organization in winning an election which of course will deal with a pragmatic and non-ideological party machine while Muhammadiyah is highly ideological in shaping a political action system.

C. Research Method

This qualitative-descriptive research is motivated by rational and objective thinking focusing on understanding and describing phenomena, not only on observing for causality towards the phenomenon under study but also on interpreting critically. This is fundamental because qualitative research does emphasize the quality of analysis and not static data.⁵⁴

Descriptive research in Harari Nawawi interpretation is interpreted as an objective problem solving research procedure.⁵⁵ Moreover, it is elucidated by Surahkmad that descriptive research generally focuses on the challenges and begins with data collection then analyzed.⁵⁶ In addition, this type of research is typically beneficial for examining hypotheses.⁵⁷

The object of the research was one phenomenon that has occurred and thus the data were collected and systematized with several data collection techniques as follows: first, it was library research in which information was collected from both books, official documents, issued by organization as material for more in-depth and comprehensive analysis. Furthermore, news and opinion coverage material in print and online mass media would be utilized.

This research was conducted on modern organization that had periodic communication media such as Suara Muhammadiyah magazine,⁵⁸ and official news of the organization as objective documents becoming references to political actions at various levels. Second, in-depth interview needed to be conducted even though this research was more dominated by reviewing literature. This was intended to verify data listed either in print media publications or different perspectives. The interview technique was semi-structured that was an interview guide containing an outline that would be asked⁵⁹ to the respondent and carried out informally or opened interview.⁶⁰

Since this research was an organization and library research, then in addition to literature review, elite interviews were conducted for cross-checking and information validation purposes. Besides, elites are

determinant and policy makers in Muhammadiyah movement as well as possess influence. The selected interview was an unstructured interview – an interview guide only containing an outline to be canvassed⁶¹ and carried out informally⁶².

The last step was data analysis in which it was a process of arranging data sequences, organizing into formula, categories, and basic unit descriptions to obtain objectives conclusion. Then, the data were categorized and crosschecked among data for validation. Moreover, data obtained from the field and literature review will be analyzed utilizing interpretative description analysis and presented in narrative form. The process was begun with reviewing data available from various sources.⁶³

D. The Broken Down but Connected Elite

There are two fundamental findings that authors discover from this study; first, the spectrum of Muhammadiyah's elite political fragmentation, and second, the causes of elite fragmentation in Muhammadiyah. Both of these are historical facts that the analysis authors have with a number of relevant theories. In addition, there are several theories the authors convey such as elite theory introduced by Vilfredo Pareto, Gaetano Mosca, C. Wright Mills, TB Bottomore, and Robert Putnam as well as the modality theory defined by Bourdieu (1986) and Putnam (1976) that will assist in describing the capital theorization that is highly fundamental in the research of political economy of anthropology-socio-politics nowadays.

As a historical fact, the emergence of group within Muhammadiyah is not entirely new. However, the authors believe that along with the political and social dynamics occurring in Indonesia, there are several interpretations that need to be revised related to the variant of the group, behavior, and political character that is not monotonous, uniform and monolithic. This group emerged in the complicated history of Muhammadiyah in the 2009 election with the emergence of Partai Matahari Bangsa (PMB) which was political climax referred to as "political fundamentalism" (Pamungkas, 2010) whose character is different from the fundamentalist group in previous Muhammadiyah.

Moreover, there are variants; such as first, political fundamentalists or called as practical political group. It was represented by Din Syamsuddin, and several figures such as Bambang Sudibyo, Amien Rais, Imam Daruqutni, Anis Matta, Hidayat Nur Wahid, Muslim Abdurrahman, Ahmad Rofiq, and so on. Meanwhile, among academics, there are

54 Bambang Purwoko, Lecture material, 1997

55 Hadari Nawawi and Matini Hadri, Instrumen Penelitian Bidang Sosial, (Yogyakarta: Gadjah Mada university Press, 1992) page. 7

56 Winarno Surahkmad, Dasar dan teknik Research, dalam Marzuki "metodologi Riset, (Yogyakarta: BPFEUII, 1989) page. 37

57 There are several descriptive research methods. However, the authors utilize case study model. The case study is why Muhammadiyah fails to support presidential and vice presidential candidate in the 2004 election? According to Yin (cited by Susilo, 1998:1), case study has three classifications such as: (1) Investigate a contemporary phenomenon within its real life context; when. (2) The boundaries between phenomenon and context are not clearly evident; and in which (3) multiple sources of evidence are used.

58 Suara Muhammadiyah or SM is the only official magazine spreading nationally and reaching more than twenty thousand exemplars as well as becoming the oldest organization communication method which has been established in 1915.

59 Suharsimi Arikunto, Prosedur Penelitian Suatu Pendekatan Praktek (cet. Ke-10). (Jakarta: Rineka Cipta, 1996), page. 229.

60 Op.cit, Lexy J. Moleong, page.13.

61) Suharsimi Arikunto, Prosedur Penelitian Suatu Pendekatan Praktek (cet. Ke-10). (Jakarta: Rineka Cipta, 1996), page. 229.

62) Lexy J. Moleong, Metode Penelitian Kualitatif, page.13.

63 Lexy Moleong., page.247

Munir Mulkan, Bachtiar Effendy, Yunahar Ilyas, Zuly Qodir, Muhajir Effendy, Syafii Maarif. In addition, they are not pragmatic and very ideological compared with the history of politics and parties such as Muhammadiyah and Masyumi figures. However, they argue that the struggle of Islam must cooperate with country, unlike Mas Mansur, Kasman S, and Agus Salim. In the 2009 election, this group attempted to convince Muhammadiyah followers of certain choices in smooth, strategic methods because Muhammadiyah members were considered to be smart at observing where their political elite were. Unfortunately, it is ineffective works. The defeat of this group in the 2009 election was the second time after the 2004 presidential election in which Muhammadiyah through the Denpasar decree formally supported the best cadre, Amien Rais, becoming a candidate paired up with Siswono Yudhohusodo.

Second, a passive moderate group which frequently conveys in public space that Muhammadiyah are in the midst of inhabitants and unwilling to division in which they believe that Islamic lecture is more crucial than political world affairs. Furthermore, they believe that politics is breaing and preaching embraces. Third, the moderate group is an active group. It is difference with passive group is that this group actively seeks and collects as well as analyzes news as material in determining political choices which may be represented by groups in the middle, namely those who have supported Amien Rais to become presidential candidates for situational reasons such as Busyro Muqodas, Abdul Mu'ti, Agung Danarto, Sukriyanto AR, Muhammad Muqodas, Zamroni Khoiruddin Bashori, and so on.

Fourth, Khitoish group tends to be flexible but possess a basis for arguments, perspectives, and principles about what organization purpose they would obey. It witnesses that they always utilize basic principle as a benchmark to struggle in the political sphere. The number of followers is immensely huge because Muhammadiyah's purposes prohibit political practice which is strong enough to be embedded in Muhammadiyah. In practical political action, they tend to keep distance and unwilling to be trapped in political agenda considered as full of intrigue. Prominent group includes Haedar Nashir, Rasyad Sholeh, Agung Danarto, and several Muhammadiyah elites in the region. Moreover, the group claims preaching through Muhammadiyah is not less noble by contributing in other field such as the political arena and even through Islamic organizations in which it is more able to prove theology of zeal or what is often called theology of *al-maun*. Meanwhile, in the political sphere many things are always converted to money.

The last is the apolitical group consisting of two types such as semi-apolitical and truly apolitical. These groups do not desire to be servant in political activities and focus on matters of worship and jurisprudence (Islamic law/fiqh). They are basically in Muhammadiyah tarjih or tabligh or are Muhammadiyah figures that are clerics with books on jurisprudence and Islamic religion as a reference

or are called as the Muhammadiyah conservative line. In addition, they are quite pessimistic and lack confidence in the democratic mechanism in which members following them also float in political choice and ultimately decide choices spontaneously. The number of these groups is numerous and many parties or candidates benefit from the floating mass of Muhammadiyah. At the level of Muhammadiyah central administrator, it is almost difficult to observe the truly apolitical. However, the authors believe that dozens of the Muhammadiyah central administrators convey "politics is dirty".

From the analysis utilized, there are several important points regarding the causes of the occurrence of breakdown of political character among Muhammadiyah elites who have not been monolithic, or what Prof. Kim notes that Muhammadiyah provides space for groups even though they are opposing each other in perspectives and actions. In summary, for instance, it can be concluded that firstly, the continuity of history occurs in the 100 year old organization. Past events are a reflection of what will happen in future. Since the emergence of Muhammadiyah, it was not in a vacuum but in the political circumstance where strategy and political communication were clearly becoming fact inseparable from the Muhammadiyah elites from 1912 to 1945. It is undeniable that Muhammadiyah had dozen of influential figures in the beginning of Muhammadiyah. Furthermore, they were categorized as ideological politician cum preacher⁶⁴. Meanwhile, Muhammadiyah politicians nowadays are pragmatic politicians or noting the term of Maarif (2008), politics is as a livelihood.

Secondly, foreign ideological intervention cannot be underestimated that the emergence of Tarbiyah movement transforming into Justice Party (PK) (1998) then became Prosperity and Justice Party (PKS) (2002) after being tumbled by the electoral threshold. The transnational ideological intervention was considered to have threatened and transformed into a destructive movement on Muhammadiyah. On the one hand, the situation resulted in strong critique at internal Muhammadiyah. The large number of Muhammadiyah young activists leaving for and choosing PKS as their new place shows the weakness of internal militancy and internalization of Muhammadiyah and proves that PKS is more Islamic, militant, and far better than Muhammadiyah as a new movement in the new age. Nonetheless, many also did not withdraw from their positions and were not active as PKS activists and administrators. There is no disobedience in the perspective of Muhammadiyah allowing cadres to involve in political party. This is what contributes to the novel phenomenon of political group in Muhammadiyah which was tumultuous in the election.

The conflict and cold war had occurred between Muhammadiyah elites who were anti-PKS and the Muhammadiyah groups in PKS such as Anis Matta and Hidayat Nur Wahid who were Muhammadiyah central administrators as well as cadres in PKS.

64 It was noted that political parties consisted of ideology and showed militancy of their ideology in 1955.

Thirdly, having inclusive and autonomous organizational design, Muhammadiyah has since been established and until now have been seen as an open and not exclusive organization. It can be observed in the variety of member backgrounds in Muhammadiyah. As an implication, there is disparity in attitudes and responses to national and local phenomena. The other organizational characteristics are the nature of autonomy given very broadly to the autonomous organizations and also several institutions which are very open to opportunities for different perspectives among thirteen central elites of Muhammadiyah. Moreover, there are phenomena that can represent the situation, for example the Tabligh assembly which is more directed to Amien Rais as his political direction where Hikmah Assembly (Majelis Hikmah) will be more inclined to support Din Syamsuddin's maneuver.

Fourthly, the elites of political pragmatism, with each modality or legitimacy basis that the Muhammadiyah elite possess, have their own way to run in politics. There are myriad of evidences that the authors have, compiled in the previous chapters in which the Muhammadiyah elite political legitimacy in the 2009 election was clearly pragmatic as expressed by Din Syamsuddin (General Chairperson of PP Muhammadiyah) supporting JK-WIN because he was disappointed with SBY and the collapse of political machine namely the National Sun Party (PMB, founded in 2006) and Muhammadiyah with 30 million citizens who are expected to be in line with Din Syamsuddin which is clearly far from expectations. Furthermore, the same is true of Syafii Maarif promoting JK-WIN which in fact has a problem with human rights enforcement and New Order regime; Golkar. Then, what seems most pragmatic is how Amien Rais silenced himself against the critical and reformed agenda that he built through Muhammadiyah, Muhammadiyah Mandate Association, until the establishment of the National Mandate Party (PAN).

At the end of political event called presidential and vice presidential election, Amien Rais and members in PAN then organized coalition to SBY-Budiono with various interests including having the minister in the cabinet and financing the party machinery. In addition, Amien Rais was appreciated as a saviour of Muhammadiyah when the vice presidential candidate who was supported by most of the Muhammadiyah elite was defeated in the 2009 election. As a result, various Muhammadiyah youth movements emerged with highly strong criticism against Amien Rais and PAN as well as a pragmatic figure whose rejection led to Amien Rais' reluctance to re-enter the committee of Muhammadiyah's central leadership.

Some young Muhammadiyah activists are likely to be able to breathe freely. However, political relations with Muhammadiyah were unfinished because Din Syamsuddin was also known as an experienced politician. Thus, Muhammadiyah in the future will experience in the political dynamics and compete among the old elite and new elite which are not monolithic.

E. Concluding Remarks

There are two main conclusions of this research. First, the spectrum of political fragmentation of Muhammadiyah elite is obvious. The emergence of groups or variants of political ideology and behavior in Muhammadiyah is not entirely new. Nonetheless, that along with the dynamics of the national and internal politics of Muhammadiyah, there are several points needed to be revised related to the variant of the group that continues to vary where the behavior or political character is not monotonous, uniform, and monolithic. This group emerged in the span of the history of Muhammadiyah which was complicated at the 2009 election by the emerging of PMB where it was the climax of political ambition of what is referred to as "political fundamentalism" whose character is distinct with the Islamic fundamentalists in previous Muhammadiyah. These variants include, first, the political fundamentalists or called pragmatic political group, second, the passive moderate group, third, the active moderate group differing passively in terms of the activity of seeking, collecting and analyzing news as material to determine political choices. Fourth, the 'Khitoist' faction arguing that political involvement is limited to what is regulated or allowed by organizational decisions. The last is the apolitical group uninterested in political affairs because they interpret Muhammadiyah not as a political organization.

The second finding is related to the causes of fragmentation of political approach among Muhammadiyah elites. It happens due to several reasons; first, historical continuity where it is a destiny in Muhammadiyah which is not monolithic. The second is the other ideology intervention that cannot be denied as a reason for the emergence of Tarbiah movement becoming main conflict between ideological political interests, especially in the era of electoral democracy – the Muhammadiyah grassroots are the most affected. Third, an inclusive and autonomous organizational design results in the strongest infrastructure for not being in a political stance. Moreover, Muhammadiyah has since been established and been seen as an inclusive and accommodative organization in socio-political interactions. The fourth is elite pragmatism, with each of the modalities and legitimacy bases owned by the Muhammadiyah elite, and they witness their own ways for determining position and thought in politics.

F. Reference

Books

- Alfian, *Muhammadiyah The Political Behavior Of a Muslim Modernist Organization Under Dutch Colonialism*, Yogyakarta: Gadjah Mada University Press, 1989.
- Asfar, Muhammad, *Pemilih dan perilaku Memiilih*, Surabaya: Eureka, 2006
- Azra, Azymardi, *Jaringan Ulama, Timur Tengah dan Kepulauan Nusantara XVII & XVIII*, Jakarta: Prenada Media, 2001
- Arifin, MT, *Gagasan Pembaharuan Muhammadiyah*, Jakarta: PT Dunia Pustaka Jaya, 1987

- Arifin, MT, *Muhammadiyah Potret yang Berubah*, Surakarta:Institute Gelanggang Pemikiran Filsafat Sosial Budaya dan Kependidikan Surakarta,1990
- Amin, M. Masyhur dkk, *Kelompok Elite dan Hubungan Sosial di Pedesaan*, Yakarta: Pustaka Grafika Kita dan YIIS, 1988
- Ali, Mukti, *Metode Memahami Agama Islam*, Jakarta: Bulan Bintang, 1987. Azra, Azyumardi, *Menuju Masyarakat Madani*, Bandung: Rosdakarya, 2000.
- Asrofi, Yusron, *Kyai Haji Ahmad Dahlan Pemikiran dan Kepemimpinannya*. Yogyakarta: Penerbit LPI, 1983.
- Baehaqi, Imam (ed), dalam *Agama dan Relasi Sosial*, Yogyakarta: LKIS, 2002
- Binder, Leonard, *Islam Liberal: Kritik Terhadap Ideologi-Ideologi Pembangunan*, Penerjemah Imam Muttaqin. Yogyakarta: Pustaka Pelajar, 2001.
- Bottomore T.B., *Elite dan Masyarakat*(terj), Jakarta: Akbar Tanjung Institute, 2006
- Budiman, Arief, (1991), *Negara dan Pembangunan, Studi tentang Indonesia dan Korea Selatan*, Jakarta, yayasan Padi dan Kapas Christenson. Reo M. et al., *Ideologies and Modern Politics*, New York: Dodd Mead & Company, 1975.
- Cribb, Robert (ed), *The Late Colonial State in Indonesia: Political and Economic Foundation of the Netherlands Indies 1880-1942*, Leiden: KITL V Press, 1994
- Darban, Ahmad Adaby, *Sejarah Kauman, Menguk Kampung Muhammadiyah*. Yogyakarta: Tarawang, 2000.
- Deni, Aji, *Konsolidasi Demokrasi, menuju Keberlanjutan Politik Indonesia Pasca Soeharto*, Yogyakarta: Kibar Press, 2006
- Djaenuri, Achmad. *Ideologi Kaum Reformis Melacak Pandangan Keagamaan Muhammadiyah Periode Awal (1912-1942)*, Surabaya: LPAM, 2002.
- Effendy, Bahtiar, *Islam dan Negara: Transformasi Pemikiran dan Praktik Politik Islam di Indonesia*, Jakarta: Paramadina, 1998,
- Eko, Sutoro *Transisi Demokrasi Indonesesia*, Yogyakarta, APMD Press, 2003
- Geertz, Clifford, *Abangan, Santri, Priyayi dalam Masyarakat Jawa*, Terj. Aswab Mahasin, Jakarta: Pustaka Jaya, 1981.
- Ghazali, Abdul Rahim (ed), *Amien Rais Dalam Sorotan Generasi Muda Muhammadiyah*, Bandung: Mizan, 1998.
- Ghazali, Abdul Rahim, *Muhammadiyah Progressif, Manifesto Pemikiran Kaum Muda*, Jakarta: JIM-LESFI, 2007
- Gaffar, Afan, *Javanese Voters, A Case Study of Election Under a Hegemonic Party System*, Yogyakarta: Gadjah Mada University Press, 1992
- Hamid, Edy Suandi (peny), *Rekonstruksi Gerakan Muhammadiyah pada Era Multiperadaban*, Yogyakarta, UII Press-PP Muhammadiyah, 2000
- Haryanto, *Kekuasaan Elite, Suatu Bahasan Pengantar*, Yogyakarta: PLOD-JIP UGM, 2005
- Huntington, Samuel P., *Gelombang Demokratisasi Ketiga*, Jakarta: Pustaka Utama Grafiti, 1991,1997
- Hefner, Robert W, *Civil Islam: Islam dan Demokratisasi di Indonesia*. Jakarta: ISAI dan TAF, 2001.
- Huntington, Samuel P, *The Clash Of Civilizations and the Remaking Of Word Order*, terjemahan, Yogyakarta: Qalam, 2001.
- Jay, Robert R, *Religion and Politics in Rural Java*, Yale University: New Haven, 1965.
- Jurdi, Syarifudin, *Muhammadiyah dalam Dinamika Politik 1966-2006*, Yogyakarta: Pustaka Pelajar, 2010
- Jurdi, Syarifudin, *Elite Muhammadiyah dan kekuasaan Politik, Studi tentang tingkah laku Politik Elite Lokal Muhammadiyah sesudah Orde Baru*, Yogyakarta: Gadjah Mada University Press, 2004
- Johnson, Doyle Paul, *Teori Sosiologi, Klasik dan Modern*, Jakarta: Gramedia, 1988
- Kato, Hisanori, *Agama dan Peradaban: Islam dan Terciptanya Masyarakat Demokratis yang Beradab di Indonesia*, di terjemahkan oleh Ismu M. Gunawan, Jakarta: Dian Rakyat, 2002.
- Karim, A. Gaffar, *Metamorfosis NU dan Politisasi Islam Indonesia*, Yogyakarta: Pustaka Pelajar dan LkiS,1995
- Kuntowijoyo, *Identitas Politik Umat Islam*, Bandung, Mizan-majalah Ummat, 1997
- Kim Hyung-Jun, *Reformist Muslims in Yogyakarta Village: the Islamic transformation of contemporary socio-religious life*, Canberra: ANU E Press, 1996
- Kuntowijoyo, *Paradigma Islam Interpretasi Untuk Aksi*, Bandung: Mizan, 1991.
- Kuntowijoyo, dkk, *Intelektualisme Muhammadiyah Menyongsong Era Baru*, Bandung: Mizan, 1995.
- Latif, Yudi, *Intelegensia Muslim dan Kuasa, Genealogi Intelegensia Muslim Indonesia Abad ke-20*, Bandung: Mizan, 2005
- Lane, Max, *Bangsa Yang Belum Selesai, Indonesia, Sebelum dan Sesudah Soeharto*, Jakarta, reform institute, 2007
- Lindbad, J. Thomas (ed), *Fondasi Historis Ekonomi Indonesia*, Yogyakarta, Pustaka Pelajar, 2002
- Ma'ruf, Farid, *Pendjelasan Tentang: Maksud dan Tujuan Muhammadiyah*, Djakarta: Jajasan Santakam Djakarta, 1966.
- Ma'arif, A.Syafi'i, *Islam dan Masalah Kenegaraan: Studi tentang Percaturan dalam Konstituante*, Jakarta: LP3ES, 1985 .
- Ma'arif, A.Syafi'i, *Islam dan Politik: Teori Belah Bambu Masa Demokrasi Terpimpin (1959-1965)*, Jakarta: GLP, 1996.
- Maliki, Zainuddin, *Agama Rakyat, Agama Penguasa, Rekonstruksi tentang Realitas Agama dan Demokrasi*, Yogyakarta: Galang Press, 2000
- Mohtar, Mas'loed dan Collin MsAndrews, *Perbandingan Sistem Politik* , Yogyakarta: Gadjah Mada University Press, 2001
- Malik, Dedy Djamaluddin, Idi Subandy Ibrahim. *Zaman Baru Islam Indonesia, Pemikiran dan Aksi Politik*, Abdurrahman Wahid, Amiern Rais, Nurcholis Majid, Jalaluddin Rakhmat. Bandung: Zaman Wacana Mulia, 1998
- Mulkhan, Abdul Munir, *Pemikiran K.H. Ahmad Dahlan dan Muhammadiyah dalam prespektif Perubahan Sosial*, Jakarta: Bumi Aksar, 1990.
- Mulkhan, Abdul Munir, *Runtuhnya Mitos Politik Santri, Strategi Kebudayaan Dalam Islam*, Yogyakarta: SIPRESS, 1999
- Mulkhan, Abdul Munir, (2000), *Menggugat Muhammadiyah*, Yogyakarta, Fajar Pustaka
- Moleong, Lexy J., *Metode Penelitian Kualitatif(revisi)*, Bandung: Remaja Rosda Karya, 2004
- Maryadi (ed), *Muhammadiyah dalam Kritik*, Surakarta, Muhammadiyah University Press UMS, 2000
- Nakamura, Mitsuo, *Bulan Tsabit Muncul Dari Balik Pohon Beringin: Studi Pergerakan Muhammadiyah Di Kota Gede Yogyakarta* Alih Bahasa Yusron Asrofi, Yogyakarta: Gadjah Mada University Press, 1983.
- Nashir, Haedar, *Dinamika Politik Muhammadiyah*, Yogyakarta: Bigraf Publising, 2001.
- Nashir, Haedar, *Dialog Pemikiran Islam Dalam Muhammadiyah* Yogyakarta: BPK PP Muhammadiyah, 1992.
- Nashir, Haedar, *Ideologi Gerakan Muhammadiyah*, Yogyakarta: Suara Muhammadiyah, 2001.
- Nashir, Haedar, *Muhammadiyah Gerakan Pembaruan*, Yogyakarta: Suara Muhammadiyah, 2010
- Nashir, Haedar, *Arogansi Kekuasaan dalam Budaya Politik*, Yogyakarta, Lentera, 1997

- Neil, Robert Van, *Munculnya Elit Modern Indonesia*, Jakarta, Pustaka Jaya, 1960
- Peacock, James L, *Purifying The Faith: The Muhammadiyah Movement In Indonesian Islam*, California: The Benjamin Publishing, 1978.
- Peter Burnham, *Research Methods In Politics*, New York: Palgrave Macmillan, 1988
- PP Muhammadiyah-partnership, *Fikih Anti Korupsi, Perspektif Ulama Muhammadiyah*, Jakarta: Majelis Tarjih dan Tajdid PP Muhammadiyah, 2002
- Rais, M. Amien, *Sukses dan Keajaiban Kekuasaan*, Yogyakarta: Pustaka Pelajar, 1997
- Rais, M. Amien, *Membangun Politik Adiluhung, Membumikan tauhid Sosial menegakkan Amar ma'ruf Nahi Munkar*, Bandung: Zaman Wacana Mulia, 1998
- Rais, M. Amien *Melangkah Karena Dipaksa Sejarah*, Yogyakarta: Pustaka Pelajar, 1998.
- Rais, M. Amien, *Cakrawala Islam Antara Cita dan Fakta*, Bandung: Mizan, 1995.
- Rais, M. Amien, et.al, *Muhammadiyah dan Reformasi*, Yogyakarta: Aditya Media, 2000
- Rais, M. Amien, *Hubungan antara Politik dan Da'wah, berguru kepada Natsir*, Bandung, Mujahid Press, 2004
- Raharjo, M Dawam, *Masyarakat Madani: Agama, Kelas Menengah, dan Perubahan Sosial*, Jakarta: LP3ES-LSAF, 1999
- Ricklefs, M.C. *Sejarah Indonesia Modern 1200-2004*, Jakarta: Penerbit Serambi, 2005
- Shihab, Alwi, *Membendung Arus, Respons Gerakan Muhammadiyah Terhadap Misi Kristen di Indonesia 1912 Hingga Masa Kini*, Terjemahan Ihsan Ali Fauzi, Bandung: Mizan, 1998 .
- Suwondo, Kutut, *Civil Society Di aras Lokal*, Yogyakarta: Pustaka Pelajar-Percik, 2003
- Sjuja', *Muhammadiyah dan Pendirinya*. Yogyakarta: Majelis Pustaka PP Muhammadiyah, 1989.
- Steenbrink, Karel A, *Beberapa Aspek Tentang Islam di Indonesia Abad ke-19*. Jakarta: Bulan Bintang, 1984.
- Stodaard, Philip H. dkk (eds.), *Change and the Muslim World*, Syracuse: Syracuse University Press, 1981.
- Sujarwanto dkk (Ed), *Muhammadiyah dan tantangan Masa Depan: Sebuah Dialog Intelektual*, Yogyakarta: Tiara Wacana, 1990.
- Suwarno, *Muhammadiyah Sebagai Oposisi*, Yogyakarta: Ull Press, 2001.
- Syamsuddin, M. Din, *Etika Agama dalam Membangun Masyarakat Madani* Jakarta: Logos, 2000.
- _____, *Islam dan Politik: Era Orde Baru*, Jakarta: Logos, 2001.
- Syaifulah, *Gerak Politik Muhammadiyah Dalam Masyumi*, Jakarta: Grafiti, 1997.
- Sutherland, Heather, dkk, *Kontinuitas dan Perubahan dalam Sejarah*, Yogyakarta: Penerbit Ombak, 2004
- Thaba, Azis, *Islam dan Negara Dalam Politik Orde Baru*, Jakarta: Gema Insani Press, 1996.
- Tim Penyusun Universitas Muhammadiyah Malang, ed., *Muhammadiyah, Sejarah, Pemikiran, dan Amal Usaha*, Yogyakarta: Tiara Wacana dan UMM Press, 1990.
- Tibi, Bassam, *Ancaman Fundamentalisme: Rajutan Islam Politik dan Kekacauan Dunia Baru*, Yogyakarta: Tiara Wacana, 2000.
- Tante, Richard r., Kenneth Young, Nur Iman Subono, dkk (ed), (1996) *Politik Kelas Menengah Indonesia*, Jakarta, LP3ES.
- Tim 1912, *Jk dan Muhammadiyah*, (buku kampanya), 2009
- Uchrowi, Zaim, M. Amien Rais, *Memimpin dengan Nurani*, Jakarta: Teraju, 2004
- Zainuri, Achmad, *Ideologi Kaum Reformis: Melacak Pandangan Keagamaan Muhammadiyah Periode Awal*, Surabaya: LPAM, 2002.
- Muhammadiyah Documents**
- Hoofdbestuur Moehammadijah, *Boeah Congres Moehammadijah Seperempat Abad tahun 1936*, Djogjakarta: Hoofdbestuur Congres Moehammadijah, 1936.
- Hoofdbestuur Moehammadijah. *Tafsir Langkah Moehammadijah*, Djogjakarta: H.B. Moehammadijah Madjlis Taman Pustaka, 1939.
- Peringatan Sidang Madjlis Tanwir Di Pekajangan Tanggal 21-24 Djuli 1955 *Isi Pelaporan Tentang: Konsepsi Negara Islam Oleh A. Kahar Muzakkir*, Dokumentasi Pusat Pimpinan Muhammadiyah Jogjakarta.
- Pimpinan Pusat Muhammadiyah, *Pedoman Bermuhammadiyah*, Yogyakarta: PP. Muhammadiyah BPK, 1992.
- Pimpinan Pusat Muhammadiyah, *Berita Resmi Muhammadiyah*, BRM. No. 04/2003 Rajab 1424 H/September 2003, Yogyakarta: PP. Muhammadiyah, 2003.
- Pimpinan Pusat Muhammadiyah, *Berita Resmi Muhammadiyah No.04 tahun 2007 tentang Tanfidz keputusan Tanwir Muhammadiyah 2007*
- Pimpinan Pusat Muhammadiyah, *Berita Resmi Muhammadiyah No.06 tahun 2009*
- Pimpinan Pusat Muhammadiyah, *Berita Resmi Muhammadiyah No.01 tahun 2005 tentang Tanfidz Mukhtar Muhammadiyah ke-45 di Malang*
- Pimpinan Pusat Muhammadiyah, *Berita Resmi Muhammadiyah, Tanfidz Keputusan Tanwir, 2009.*
- Magazine/Paper/Bulletin**
- Journal TANWIR*, edisi Perdana, Vol 1, No. 1, Mei 2003. PSAP.2003
- Journal PROFETIK*, vol. VI, No.1, tahun 2002.
- Journal PROFETIK Mei 2003.*
- Panjimas Edisi 05/Th I 27 Nov – 12 Des 2002
- Suara Muhammadiyah No. 22 Tahun ke-65, 1985, edisi bulan Nopember tahun 1998, edisi Desember 2002, no.21/TH ke-91 /1-15 November 2009
- Harian Kompas Selasa 29 Januari 2002.
- TEMPO, 11 November 2001, TEMPO, 10 September 2000
- Republika, 7 September 2001.
- Majalah Tempo edisi 30 Maret-5 April 2009
- Maarif Institute, 100 Tahun Muhammadiyah, Civil Society dan tantangan Gerakan Islam Transnasional, Jakarta, Jurnal Maarif, Vol.4. No.2/Desember 2009
- Republika, 6 Mei 2010, Opini, *kelas menengah Islam Baru*, Azumardi Azra
- Suara Muhammadiyah edisi 16-31 Maret 2009, 16-31 Mei 2009, 1-15 Juni 2009, 16-30 Juni 2009.
- Abdul Munir Mulkhan, makalah, *Muhammadiyah Rindu Kuasa?*, dalam seminar Muhammadiyah dan peran Politik Kebangsaan, 22 April 2009, di Yogyakarta.
- Materi Tanwir Muhammadiyah tahun 2007 di Yogyakarta
- Suara Muhammadiyah, edisi no.10/TH.ke-94/16 Mei 2009
- Suara Muhammadiyah, edisi no.12/TH.ke-94/16-30 Juni 2009
- Suara Muhammadiyah, edisi no.6/TH.ke-94/16-31Maret 2009
- Suara Muhammadiyah, edisi no.10/TH.ke-94/16 Mei 2009
- Majalah Gontor, Edisi 03 Tahun VII Juli 2009
- Online sources/Website**
- http://www.m-amienrais.com/news/one_news.asp?IDNews=139
- <http://islamlib.com/id/artikel/kepemimpinan-santri-dan-dilema-kekuasaan/>

<http://oki-sukirman.blogspot.com/2009/03/komunikasi-politik.html>
<http://sakha140887.multiply.com/journal/item/6>
www.muhammadiyah.or.id
<http://www.ahmadheryawan.com/opini-media/sosial-politik/2792-pan-pmb-dan-muhammadiyah.html>
<http://www.tribun-timur.com/read/artikel/98999/Komunikasi-Politik-Ala-Muhammadiyah>
http://www.muhammadiyah.or.id/index.php?option=com_content&task=view&id=1990&Itemid=2
<http://pdpmsleman.wordpress.com/2007/03/18/sikap-pp-pemuda-muhammadiyah-terhadap-pmb/>

The Involvement of Russian Government In The Syrian Civil War

1st Husni Amriyanto Putra, Drs. M.Si.
International Relations Department
 Universitas Muhammadiyah Yogyakarta (UMY)
 Yogyakarta, Indonesia
choenny@yahoo.com

2nd Mitha Shafraa
International Relations Department Universitas Muhammadiyah
 Yogyakarta (UMY)
 Yogyakarta, Indonesia
shafraamitha@yahoo.co.id

Abstract— *As the rising of Arab Spring in 2011, some countries in the Middle East started to do demonstration to pursue the better governmental system which adjusts Democracy into the system. In March 2011, Arab Spring influenced Pro-Democracy people in Syria who mostly Sunnis to overthrow its authoritarian president, Bashar Al-Assad by doing demonstration. Assad is also known as an authoritarian president because of his inheritance of governmental position and in military sector to his family who believes in Shi'i Alawite. In July 2011, the conflict escalated and made Assad responded by heavier forces against the protestors. However, United States and European countries criticized and strongly condemned toward Assad's manner in facing the conflict with his citizen. Meanwhile, Iran and Russia stay supporting and appreciate the decision of Assad to preserve his position as a president. Especially Russia, they help Syria in fighting against the opposite of Syrian government in any kind of form such as military aid, troops, and medicine. This undergraduate thesis will analyze the external and internal factors of Russian decision on their Foreign Policy toward Syrian Civil War. Moreover, this undergraduate thesis will also show the needs of Russia in intervening Syrian Civil War.*

Keywords— *Russia, Syria, Syrian Civil War, Intervention, Interest*

I. INTRODUCTION

Syria is known as a place where the big crisis of humanitarian in this 21st century happens, the next Proxy War, and also a war between Sunni and Shi'a Muslims which escalates the gap between these 2 different sects. Syrian Civil War occurred as the impact of Arab Spring which was happened in December 2010. A throwback to the time when Arab Spring was begun, it was started to spread in the Middle East and North Africa countries and tried to change the governmental system in most of the Arabian countries such as Tunisia, Egypt, Bahrain, Libya, Yemen, Lebanon, Algeria, Jordan, Oman, and Syria. Arab Spring is a term for the wave of social protest where the uprising of revolution toward Pro-Democracy happened (Mohamedou, 2012).

Arab Spring seems does not fit in Libya, Yemen, and Syria because of its government who it to happen in their country. Therefore, the response of Arab Spring in Libya, Yemen, and Syria was a disaster for the people who pro-democracy in those countries because it is fulfilled with bloody refused civil war, violence, terrorism, and a big mass of fleeing refugees (Staff, 2011). Furthermore, among the destruction that happened in the Arab Spring, the most complex and breath-taking destructions are in Syria. Many people assumed that Bashar Al-Assad is the one who responsible for every mess that

happened in Syria. He is an official president of Syria since 2000. He was a big hope for Syrian people to bring a better regime. At the beginning of his era, he could generate Syria economically and politically, such as exporting agricultural product and oil (Haran, 2016). Therefore, he was sure that Arab Spring will not touch a peaceful country like Syria.

The other reason for Arab Spring occurred in Syria is because of the political suppression. There was no political party in Syria besides Ba'ath party who can lead Syria. The other example of no freedom in Assad's regime is the apprehension of a group of young men in Dar'a for drawing anti-regime graffiti was incongruous because Al-Assad captured, tortured, and even killed them. This action tempted big mass protestors about the cruelty of the government under Bashar Al-Assad. He tends to use military and security forces to face the protestors, while Syrian military training for the external threats but not for the internal disturbance. As the result, government coalition with the military against civilians meets the dimension of Civil War (Manfreda, 2017).

In the bloody Syrian civil war, to keep the balance of power from the opposition groups who fight against the regime, Syria has aligned with a superpower country and a country who has the same belief with Al-Assad, they are Russia and Iran. Iran supports Syria at the regional level because it has become the staunchest supporter of Assad and it's a part of Alawite community. While Russia, gives support at the global level, because Moscow provides an obvious a diplomatic shield for Damascus regime, and support it with arms supplies.

On September 4th, 2015, in Vladivostok, Russian President, Vladimir Putin stated that "We signed major contracts with Syria some 5-7 years ago, and we are complying with them in full....However, we will continue our consultation both with our friends in Syria and with the countries in the region." (Rahman, 2016) This statement clearly expressed that Moscow will support Damascus unconditionally and took any risk that would happen to Russia itself. In this thesis, the writer will focus on how deep Russian involvement in Syrian Civil War and also will try to explain how the internal and external affairs can influence Russia to involve in Syrian Civil War.

II. THEORETICAL FRAMEWORK

A. Perception

According to the book, *The Logic of International Relations* that has been written by Walter S. Jones and K. J. Holsti, Perception has an important role in influencing the actors of world politics that caused a conflicting situation in the international arena. Moreover, according to Walter Jones,

perception is about the subjective ways of someone in defining facts. Perception is one of the crucial factors of Human behavior because it could construct or shape the behavior of someone or something and perception influences the impressions of someone for other people's traits and personalities. Furthermore, Walter S. Jones has divided the composition of the concept of perception into three parts, there are: 1) Belief which has a definition about the certainty of someone towards reality description is proved, true, and known. Usually, belief is based on the acceptance of the information from the environment, even though sometimes is not always similar to the existing data. 2) Value means someone's preference toward a certain statement of reality over the others. Moreover, a value is not referring to what does exist but tends to what should exist. 3) Cognition is the fundamental base for the building or changing the perception system. The concept of changing national perception refers to introduce the new cognition that will change the beliefs and values of that state itself (Alfadh, 2012). In the relation with this thesis, Cognition has a role in providing Russia the information about Syria which has influence Russia to assist and support Syrian Government in the Syrian Civil War.

B. Geopolitics

Geopolitics is a science that based on geography and has a strong interaction and relation with the political powers of a state, therefore the core of a region from the geographical point of view provides an arrangement for geopolitics and must to be proceeded to succeed for the long term. In addition, Geopolitics also means that geographic factors are important to be considered for the diplomatic and military planners in every decision making of policy or strategy in order to increase the performance of a state in the world arena for a long term. There are some aspects to analyze Geopolitics in order to help the policymakers in making certain political conclusion and project for the future. According to Cohen, there are 2 important aspects: 1) The description of geographic which relate to political power. 2) Put the spatial frameworks that include interacting political power units.

C. Geo-strategy

Geo-strategy is a subfield of geopolitics and it explains the strategy of geopolitics or known as a geographic guideline for a state's foreign policy. Moreover, geostrategic stresses the efforts of a state in maximizing the project military power and maneuvering diplomatic activity. However, a state has limited resources and capabilities, therefore they must focus on the specific areas of this world in the military and political way. Geo-strategy of a state is not always motivated by the geographic reasons or geographical actors, but it could be based on similar ideology, interest group, or even from the interest of the leader (KumarSahoo, 2010). Furthermore, a geo-strategy of a state usually can be described by using some standards, which are: 1) the position of a state by geographically and its relationship in the military operation arena. 2) The position of a state from the important regions and international communications such as trading and economic area, industrial regions, or transportation lines, natural resources, etc. 3) A state's territorial size, in order to organize the needs of defense and to conduct the military operation. 4) Utilizing the geopolitical space to fulfill the military sector especially for military construction and conducting a war. 5) The distance between the potential and the real area for a war and military conflicts (Isakova, 2005).

III. RESEARCH METHODOLOGY

This research used qualitative research method by data collecting. The method of data collecting is conducted through the library research such as printed and electronic media, online newspaper, internet, video, articles or journals and some reference books.

IV. CONTENT

The involvement of Russia considered as the worsening factor of this conflict since it has caused a lot of people died and made Syria as the big producer of refugees fleeing out of the country. Moreover, to know and understand the alliance of two countries or more, it is important to have an assessment to understand the history between those countries who involved in a treaty or agreement. Thus, History could help to analyze and explain the behavior and treatment of a country towards the others, and give the time-ranging toward the dynamic of the relationships itself. Furthermore, the other important aspect of understanding a relationship two countries or more is from the similar background they share with each other.

A. The History of Relationships between Russia and Syria

The relationship of Russia and Syria was formally established since the Post-Cold War began when the Soviet Union was collapsed. Russia has gone through an instability period of time, politically, economically, and also socially. For example, since the collapse of Soviet Union, the military of Russia was struggling to face a lot of problems regarding the shortage equipment and lack of training and discipline. Moreover, in the Post-Cold War, Russia was also suffering from the proliferation of corruption, also they became fragile and even lost its allies. Since then, Russia focuses to put their main interest on the former of Soviet Union.

Moreover, the relationship of Russia and Syria established because of the similar problems that they have which are the issue of radical Islam movement and also Russian desires to have an access to the Mediterranean Sea. Thus, Syria appeared to support Russia to rise up again from the fall and they become a "support-system" until now. It is also proved with the Treaty of Friendship and Cooperation which signed on 8th October 1980 by Leonid Brezhnev, the Head of the Soviet Union and Hafez Al-Assad, the leader of Syria.

Historically, their relationship existed since 1944 by diplomatic links. Since 1950 until 1980 they were often to do multi-faced bilateral relations, specifically in the military trading. Furthermore, this relationship escalated since Egypt decided to separate from the Soviet Union and became allies with the United States. It makes Syria become the country that got a lot of Soviet attentions in weaponry systems in the Middle East. Russia also wants to restore its importance in the international view and to get the prominent position in the Arab – Muslims world (Kreutz, 2010).

B. The Similar Background of Russia and Syria in Fighting Separatism

The Long-standing relationship between Syria and Russia is not only because of the weapon and oil trading, yet it is also due to the each country's trauma toward the separatism. Since 1991, after the Soviet Union fell down, it lost some important part of its members like South Caucasus countries and Central Asia which are Georgia, Azerbaijan, Armenia, etc. Moreover, Russia needs to face the current issue of separatism which is

the insurgency of North Caucasus. It led by the Extremist Sunni Muslims who wanted to be independent of Soviet Union due to the different interests that they have. There are more than 20 million Russian Muslims living in North Caucasus and had 2 wars with Russia. Besides

The other issue is about Ukraine and Crimea, Ukraine was a part of USSR or Soviet Union until 1991. As the fall of Soviet Union, Ukraine declared to follow the rules of Ukrainians laws rather than Soviet Union's and took Crimea along with them. Before 2014, Crimea did not belong to Russia because it was under Ukraine's authority yet Ukraine made it became an independent state. However, there was an issue that the citizen of Crimea wanted to rejoin Russia. Recognizing this good news, Vladimir Putin was welcoming Crimea to come back home. In Crimea Referendum in 2014, it declares that Crimea wants to be with Russia which proved by the result of the Referendum itself (Draxhev, 2014).

For Ukraine, Crimean Ethnic (Tartar) and the Western countries this referendum is illegitimate, therefore Ukraine responded in an aggressive way toward it and put its military on the border of Ukraine-Crimea. Seeing this response, Russia who has full authority of Crimea also put his troops on the border of Crimea to maintain the military occupation of Ukraine in the area (Curran, 2015). Since then, these two countries still have a high tension among them. In addition, Russia also facing the rebellions from the Crimea, the Tatar Crimean people who are known as the Muslim minority that lives in Crimea for centuries.

Furthermore, in this 21st century, Syria also needs to struggle to fight against most of his citizen, Sunni Muslims who asked for freedom from Syria government. They wanted to topple down their president because of their prejudices toward Assad practicing bad governance like corruption, so on and so forth. On the other side, during the Syrian Civil War, there were a lot of groups came from neighborhood Muslim states tried to divide and take over Syria from Bashar Al-Assad such as ISIS, Al-Nusra Front and Free Syrian Army who also consider as the group of extremist Muslim (Cafarella, 2016). Moreover, in 2012 there were several countries, especially the western countries that illegally involved in this war and supported those rebellion groups to be free from a dictator leader, Bashar Al-Assad. Those countries are the alliance that supports the separatism between the former of Soviet Union countries and Russia (O'Connor).

C. The Similar Background of Russia and Syria in Fighting Western Countries

The Falling of the Soviet Union caused by several reasons and one of them is because of the influence of United States who supports the destruction of USSR itself. The strategy of Democracy which known as the American system also shaped the tactics for the main actors in the destructing Soviet Union, for example, by influencing Mikhail Gorbachev and Boris Nikolayevich Yeltsin to practice Pro-western such as Democracy in his regime. Mikhail Gorbachev is the former of Soviet Union leader who stimulated the drama of the falling of Soviet Union. He is a close friend of United State's former president, Ronald Reagan. Many people see that the end of Cold War could come up because of their warm relationship.

According to his interview with BBC, Mikhail Gorbachev stated that "A split in society and a struggle in a country like

ours, overflowing with weapons, including nuclear ones, could have left so many people dead and caused such destruction. I could not let that happen just to cling on to power. Stepping down was my victory." It means he tried to avoid the civil war that will happen just because to protect his position and power as a leader. Therefore, in December 21st, 1991, Soviet Union is officially collapsed and for the West, they see Mikhail as the hero for the Soviet Union due to its effort to bring freedom there, yet for some ex-Soviet Union people, Gorbachev is a betrayer (Rosenberg, 2016).

Furthermore, the establishment of NATO considered as the action to prevent and keep the balance of the United States and the other European countries toward the rising of the Soviet Union and its allies after the World War II or at the beginning of Cold War. Certainly, for western leaders, Soviet Union was spreading a threat to Europe by influencing East Europe with the ideology of Soviet Union in order to join USSR as one of its allies (Gedjošová, 2015). In the current issues, NATO tried to support Ukraine for its revolutions. However, Russia reacted by using military forces to those who threaten their interest and improved the Ukraine – European Union economic relationship to influence European countries in favor with Russia. On the other hand, the United States and NATO retaliated Russian aggression by expanding their policies to Europe, and one of NATO's policies toward Europe is European Reassurance Initiative. By this policy, NATO would like to increase the risk and cost of Russian Aggression.

At the same time, Bashar Al-Assad is anti-western, anti-Israel and Pro-Palestinian policies. Bashar Al-Assad has a skeptical view toward the west and Israel, and it was increased when the Syrian Civil War began. Syria has a tension with Israel due to its conflicting border since a few years ago. The government of Syria also has increased its military service toward the conflict and tried to utilize its military to give Palestine freedom. In September 2011, Assad sent Palestine people to live in Syria, especially to the Israeli's border in order to show the strength of Syria and the resistance toward Israel (5Pillars, 2016). This thing is one of the reasons that made Syria become anti-western, due to the relationship and the support that the United States gives to Israel, it makes Syria become more skeptic to the west.

However, since the crisis happened, Bashar Al-Assad knew that his citizen wanted perfect democracy and freedom to be implemented in the country, and wanted Assad to step down from the governmental system and give his authoritarian leadership up. However, he declined his citizen desire and using military force to face them in order to hold his position on (Haran, 2016). Syria has a cynical view of the western especially United States because of the involvement of U.S in Syrian Civil War. He admitted in his interview with the Australian SBS TV in 2016, The West has a misinterpretation, misconception, or probably kind of propaganda toward Russia and Iran who supported Syria government in The Civil War. Assad blamed the warmongers on the American administration who provoked the situation in Syria. Moreover, he stated that the American administrations since 50's are very popular with creating chaos in another country regardless solving the problem itself. American power in invading other countries was a big deal, especially when the US invaded Iraq, Libya, Syria and Yemen, they have not achieved anything. Again, Assad stressed that America and its allies only good at creating a problem but never really solving it (Al-Assad, 2016).

D. Russian Strategy in Military Sector for the Syrian Crisis

In the Syrian Civil War, Vladimir Putin has brought the cooperation in the military sector into another level. In February 2012, Russian Foreign Minister, Sergei Lavrov was given orders by the president to go to Syria for a peace mission during the Syrian Crisis and he was accompanied by the head of Russia's Intelligence Service, Mikhail Fradkov. In that discussion, they were talking about the stockpiles of Syria's chemical weapons, military and its territory. Russia also supports Bashar Al-Assad in order to improve the naval facilities in the northern mountains on the Mediterranean Sea. And also, to get the naval facilities secured and maintained with the protection from a very loyal and convenient ally which is Assad and his Alawite clan (Saradzhyan, 2015).

Russia has expanded Russian Port facilities for the naval base at Tartus as well as their air base in the south of Latakia. It has taken the world's attention because Russia seems to build up a Russian airbase which gives a capability to involve actively in the Syrian Civil War when Assad has been losing ground. Putin and Russia have been in the same position before the Syrian crisis. In 2008, Russia had a plan about the major expansion of its naval base in Syria as the hard-line that they took in facing the US and the west over the transmission of missile defense in Poland and in defense of Russia invasion in Georgia.

Further, on September 30th, 2015, Russian military initiated the establishment of an air base in the south of Latakia, a city close to the Mediterranean Sea. Moscow and Damascus saw all the opposition groups as the terrorists that should be combated, and yet Russia has always refused to join US coalition to fight terrorism, instead, Moscow started to merge an alliance with Syria, Iraq, Iran and Lebanese Hezbollah. In Latakia, T-90 tanks, the marines from Russia, combat vehicles, and artillery distributed in order to protect the air base from opposition groups. In addition, Russia also sent about 300-500 marines, the Su-24 and Su-34 fighter-bombers, Su-25 ground attack aircraft, Mi-24 attack helicopter has distributed to Latakia in order to give a long-last protection for the Syrian government (Kaim & Tamminga, 2015).

In 2015 and 2016, Russian involvement in Syria has finally succeeded to help the Syrian government to recapture a mere of two percent from its territory. Russia air strike reportedly had a significant effect on the battlefield, besides that, at the beginning of Russia involvement, they succeeded to help the regime to secure its main key roads, developed Syria infrastructure and isolated Syrian opposition bases as well as destroyed every hardware of heavy military that they found from the opposition groups (Iddon, 2017). Neil Hauer, an expert on the relationship between Russia and Syria who has followed the crisis stated that Russia has improved their military ability as they demonstrated it in the Syrian war. Hauer declared that they were using fewer frontline battles in Syria, and they have involved in support roles, for example by giving advisers, ground forces and air army.

E. Russian Strategy in Political Sector for the Syrian Crisis

Russia has played an important diplomatic role for Syria, in late December 2012, Russian Foreign Minister, Sergei Lavrov declared that Russia will not sign up for any diplomatic resolutions to the Syrian crisis based on western nor Arabian countries terms. In 2015, Russia started a remarkable move in diplomatic activity which has triggered by two factors. The

first one is because of the rise of ISIS who threatens the regime position on the ground, and the second is because of the nuclear agreement between international community and Iran. Maria Kholdynskaia – Golenishcheva, the representative of Russia in United Nation in Geneva, was giving a statement toward the development of Syrian Crisis that it was the mistakes of Turkey, Qatar, Saudi Arabia and the West for supporting the opposition groups. Dmitry Kiselev also stated that the US stands on the same frontline with the terrorist because they tried to ruin Syria as a secular state (Mark N & Fairfax, 2015).

In the International Political level, Moscow has issued three UN Security Council vetoes to ignore a peaceful shifting of authority and refused to involve in the call for Bashar Al-Assad to go from his current position as the president of Syria. Moscow does not believe the Security Council should be in the business of either implicitly or explicitly supporting the removal of sitting government. Moreover, Russia believes that United States interventions in some countries have resulted in a regime change like in Kosovo, Afghanistan, Iraq, and Libya. Russia sees it as a threat to them, the stability of the international political system, and has potential to destruct regime stability for Russia and its allies (Charap, 2013).

Putin's decision in involving Syrian civil war was also based on their interests toward political power and influence. Russia has confirmed its foray into Syria as a part of their efforts to reduce terrorism by backing up the Assad regime. According to Vladimir Putin statement, the collapse of Syria Regime will only mobilize the terrorist. For this time, instead of undermining Syrian regime, the world supposed to revive them and strengthening the international institutions to support Syrian Government. For Putin, the failure that happened in Libya, Syria and North Africa combined with the rising of Islamic States demonstrates the mistakes of the west from undermining the authorities of the states in the region.

Moscow also tried to send a message to the world that, Unlike United States, Russia will be always on the side of authorized government and leaders against the opposition groups who want to take control, and also popular uprisings. It showed from Russia's support in Resolution 2554 adopted by United Nation Security Council in December, 18th 2015 which encourages all the parties to find the sustainable solutions for the Syrian crisis. In this case, Russia has a big chance in setting an alternative solution on handling conflicts in the Middle East and restoring their international pride since they have lost it in the Ukraine Crisis (Stent, 2016).

F. Russian Economic Interests in the Syrian Crisis

For Russia, one of the main reason they chose to involve in Syrian civil war because of their interest in the economic sector. Since Russia has been imposed by the economic sanction from the west due to its Annexation of Crimea, Russia's economy has been in deficit for some last years and made the Russian lived below the standard of living. Syria has known with its strategic geography in the Arabian land, they have the largest natural gas in the world as well as Iran and Qatar and has distributed their oil to European Union. Moreover, Milad Jokar as the Middle East Expert, he stated that Europe has significant demand for gas energy, and a quarter of it filled by Syria. In this last 6 years, Syrian Civil War has made the Economic of Syria collapsed, yet, fortunately, the resource business could help them to survive (Gordon, 2017). Russia was trying to preserve their access to

Syria's market, ensured that Syria will be the loyal customer of Russian arms and machinery and also cooperate further in the oil and gas sectors to develop Russia's economic (Saradzhyan, 2015).

Furthermore, Syrian pipeline gas is very controversial in the Arabian land, before Syrian crisis came up, the Gulf States made a plan to build a pipeline through Saudi Arabia, Jordan, and Syria. However, Assad declined this project and preferred to make a pipeline-agreement with Iran. European countries prefer the Gulf States pipeline, so they can isolate Iran by not buying their natural resource. This pipeline project just sharpens more the difference between the Gulf States pipeline (Sunni) and Syria – Iran pipeline (Shia). For Russia, if the opponents succeed to overthrow Assad from his positions, it could threaten the energy deals between Russia – Syria since Syria has shared its natural resources to Russia and from their cooperation on natural resources, it makes Russia become the main exporter of Gazprom to European countries (Jokar).

Moreover, Russian interest toward Syrian gas natural resource is as a complementary supplement for developing Russia's economy. Yet, Russia needed Syrian strategy to ensure that other countries will not increase supply in the way that competes with them. Russia prefers to recognize Syria as the transport hub rather than a supplier of energy and oil, therefore Russian companies look forward to participating in the Syrian energy development rather than being a rival to it. As the consequences, all the countries who want to ship its petroleum product through Syria should consider Russia and negotiate with it (Editor, 2017).

Further, in 2015, Gissa Gutchel, the executive director for Russian Oil and Gas Producers Union said that after the situation of Syria is stabilized, the Russian companies that had to freeze due to the civil war will quickly resume activity and fulfill their contract again before the war and has value for minimum \$1.6 billion. In order to fulfill Gutchel's requirement, President Bashar Al-Assad gave an unprecedented way for Russia to access Syrian energy sector by using the offensive Syrian Army. In February 2016, Syrian delegation flew to Russia to meet the Ministry of Energy for asking help through Russian oil and gas companies to restore Syria's energy that has been destroyed by the civil war. The other company is Stroitransgaz, a Russian engineering company in the field of oil and gas has built a natural gas pipeline in Syria and currently they establish a second plant near Rakka which will produce 1.3 billion cubic meters of gas.

Furthermore, Russia also developed their economic sector and invested their money on Syria by selling their military aids and services. For 20 years period, Syria could not cut Russia from their top list of a weaponry-producer country. In 2011, there was a Syrian representative who bought Russian arms such as Anti-tank and air-craft missile system for \$4 billion to develop the security capabilities. From the weaponry system, since 2009 Russian companies have invested \$20 billion in the war, and the prime minister of Russia also confirmed that Russia admitted they supply the military weapons to Syria and it is worth for hundreds of million dollars and the total demand for Russia has estimated for \$15 billion dollars. However, all this agreement could be abolished if Assad toppled down from his position, therefore Moscow involved in this war and gives a fully-support to Bashar Al-Assad (Talukdar, 2016).

Furthermore, Russia is also interested in Palmyra, a historical city in Syria that located near to JabalShaer which has natural gas and was occupied by ISIS for some last years. IS has taken over Palmyra in May 2015, this city produces 45% of Syrian gas and electricity resources. This city is also as a transit place for pipeline gas that carried from several fields in north-eastern and eastern Syria, therefore, Russia tried to free Palmyra from ISIS. On 30th March, Russian engineers came to Palmyra and did their mission which is mine-clearing. The sappers cleared the roads from the mine and they succeed to detect and tame the improvised explosive device which has put in several buildings and roads.

V. CONCLUSION

Since 2011, the bloody Syrian civil war has stolen world's attention due to hundred thousand people died in that war. This war has been lasting for around 6 years with many of actors involved in it and made it become so complex. In the beginning, it was only the conflict between Syrian government and its citizen, and it grows and pulls the actors from big countries such as United States, France, and Arabian countries to play a role in the civil war. Responding to the illegal involvement, Bashar Al-Assad as the legal Syrian president who almost being overthrown from its position, asked for help to one of his best ally, Russian Federation. In 2015, they formally involved in the war, yet in 2012 they already have contributed by sending some weaponry aids.

The involvement of Russia in Syrian Civil war makes the situation became worse and the amount of victim has increased every year. Western countries accused Russia due to the practice of chemical weapons and dropping bombs on Syrian people by ignoring the bad impact from it. Nonetheless, Russia has put its best to protect the Syrian government who killed its citizen without mercy. Russia has sent its military weapon and aids to Syria. However, Russia interested in joining the war and gave a big contribution for Syria because of several reasons. The long-last relationship that has been stranded since Cold War is one of the reasons that make Russia support the Syrian regime. Moreover, Russian interests on Syria also become the main reasons why Russia wanted to assist Syrian government.

This thesis proves that Russia has a geopolitical interest in Syrian Civil War by using the Concept of Geopolitics by Saul Bernard Cohen. By sending its advanced military weaponry systems and aid, Russia successfully got the full access of building naval and air base in Latakia and Tartus. Moreover, these cities are located next to the Mediterranean Sea. For Russia, to have a power in the Mediterranean Sea would bring a lot of benefits to them since it has busy trading routes. Moreover, Syria is also known as its natural gas resource and the pipeline. Since the war happened, Syria and Russia have an agreement toward sharing Syrian natural gas resources. Not only that, Russia also interested about the Syrian pipeline that very controversial in the Middle East because it has a strategic position that can connect the flow of natural gas from the Middle East to Europe.

Furthermore, behind all the materialistic reasons, Russia has a long history with Syria. The relationship among these countries is close enough, they support each other during the Cold War and Syrian Civil War. Syria also has the similar background, vision and mission with Russia, therefore, Russia will support them to fight the terrorism and separatism in Syria. Nonetheless, Putin's decision in helping Assad is because of

the political power and influence. Before Syrian Civil War occurred, Russia never really stated that the interest to join western countries to fight terrorism. Nevertheless, in the Syrian crisis, Russia has shown that they established “anti-terrorism coalition” together with Iran and Syria. This coalition has their own way to minimize terrorism in their country which more successful, unlike the western does. Russia wants to show the world that Moscow can be as the main key to reach glory.

The other reason for Russian involvement in Syrian Civil War is because of the similar perception of Russia and Syria in dealing and understanding the civil war. Russia and Syria have a similar problem. Russia and Syria do not like the existence of Separatism in their country, for them, separatism is the beginning of disunity of a state. Russia needed to face the rebellions on North Caucasus like Chechen and Dagestan and also some countries in Central Asia. Because of the movement of separatism, Soviet Union has collapsed. Similar with Russia, Syria also needed to deal with the Rebellions in their country.

Besides anti-Separatism, Russia and Syria also have a skeptical view toward western countries and the idea of democracy. The Fall of Soviet Union was as the result that the Western countries could divide the former of Soviet Union members by influencing them with western democratic peace. Moreover, the western established NATO to prevent the reviving of Soviet Union and communism as well. Meanwhile, for Syria, the intervention of Western countries in the civil war recognized as an illegal intervention to an independent country and abusing their sovereignty. Like in Libya, Iraq, Yemen, and Syria are the fail products of Western intervention. Because the force of the West who wants to inject the idea of democracy to Middle East. Therefore, Russia has a willingness to help Syria so Western cannot just intervene their sovereignty as an independent state.

REFERENCES

- [1] 5 Pillars. (2016). Why Present Pro-Assad Propaganda as "Anti-Western, anti-Zionist" truths? Retrieved January 15, 2018, from 5Pillars: <https://5pillarsuk.com/2016/12/11/why-present-pro-assad-propaganda-as-anti-western-anti-zionist-truths/>
- [2] Al-Assad, B. (2016). Bashar Al-Assad Interview: Western Nations are Supporting The Terrorists. Retrieved January 16, 2018, from Global Research: <https://www.globalresearch.ca/bashar-al-assad-interview-western-nations-are-supporting-the-terrorists-us-counter-terrorism-campaign-is-bogus/5533940>
- [3] Alfadh, M. F. (2012). Persepsi Gerakan Mahasiswa Islam Terhadap Politik Luar Negeri Indonesia di Timur Tengah. Yogyakarta: Prudent Media.
- [4] Cafarella, J. (2016). Why The Most Dangerous Group in Syria isn't ISIS. Retrieved January 23, 2018, from CNN: <http://edition.cnn.com/2016/02/26/opinions/syria-isis-al-qaeda-nusra/index.html>
- [5] Charap, S. (2013). Russia, Syria and Doctrine of Intervention. London: Survival.
- [6] Curran, J. (2015). Russian-Ukrainian Conflict Explained. Retrieved April 6, 2018, from Huffington Post: https://www.huffingtonpost.com/john-curran2/russian-ukrainian-conflict-explained_b_4909192.html
- [7] Draxhev, V. (2014). Crimea Declares Independence, Seeks UN Recognition. Retrieved April 6, 2018, from RT Questoin More: <https://www.rt.com/news/crimea-referendum-results-official-250/>
- [8] Editor. (2017). Key Facts for the Economic Gains of the Russians Intervention in Syria. Retrieved February 24, 2018, from Rawabet Center for Research and Strategic Studies: <http://rawabetcenter.com/en/?p=1567>
- [9] Gedjošová, I. (2015). NATO: What is NATO? Praha: Asosiace Pro Mezinárodní Otázky (AMO).
- [10] Gordon, S. (2017). Russian Resolve: Why Syria Matters to Putin. Retrieved February 20, 2018, from The Globe and Mail: <https://www.theglobeandmail.com/news/world/russian-resolve-why-syria-matters-to-putin/article34643406/>
- [11] Haran, V. (2016). Roots of the Syrian Civil Crisis. Institute of Peace and Conflict Studies , 8-9.
- [12] Iddon, P. (2017). For The Russian Military in Syria, Old Habits Die Hard. Retrieved January 31, 2018, from War is Boring: <https://warisboring.com/for-the-russian-military-in-syria-old-habits-die-hard/>
- [13] Isakova, I. (2005). Russian Governance in the Twenty- First Century: Geo-Strategy, Geopolitics, and Governance. New York: Frank Cass.
- [14] Jokar, M. (n.d.). War in Syria: Geopolitics of The Conflict. Retrieved February 20, 2018, from The World Post: https://www.huffingtonpost.com/milad-jokar/war-in-syria-geopolitics-_b_2378683.html#
- [15] Kaim, M., & Tamminga, O. (2015). Russia's Military Intervention in Syria: Its operation Plan, Objectives, and Consequences for the West's Policies. Stiftung Wissenschaft und Politik , 1.
- [16] Kreutz, A. (2010). Syria: Russia's Best Assests in The Middle East. Paris: IFRI.
- [17] KumarSahoo, D. (2010). A Geopolitical Perspective on Central Asia - China Relation. Jawaharlal Nehru University , 46-50.
- [18] Manfreda, P. (2017). Top 10 Reasons for The Uprising in Syria Reasons behind The Syrian Uprising. Retrieved November 3, 2017, from ThoughtCo: <https://www.thoughtco.com/top-10-reasons-for-the-uprising-in-syria-2353571>
- [19] Mark N, K., & Fairfax. (2015). Russian Intervention in the Syrian Civil War. Russian Analytical Digest , 8.
- [20] Mohamedou, M.-M. O. (2012). The Arab Spring in Historical Perspective "The Arab Uprisings: A Conflict Transformation Perspective. Institute for Conflict Transformation and Peace Building , 3-9.
- [21] O'Connor, T. (n.d.). How the U.S Lost The War in Syria to Russia and Iran. Retrieved January 23, 2018, from Newsweek: <http://www.newsweek.com/us-lost-war-syria-iran-russia-winning-final-battle-674833>
- [22] Rahman, S. M. (2016). Syrian Civil War: A Historical Study from The Russian Perspective. Arcjournals , 2.
- [23] Rosenberg, S. (2016). Mikhael Gorbachev: The Man who Lost an Empire. Retrieved January 6, 2018, from BBC: <http://www.bbc.com/news/world-europe-38289333>
- [24] Saradzhyan, S. (2015). Russia's Interest in Syria is not Assad. Retrieved April 17, 2018, from Belfer Center: <https://www.belfercenter.org/publication/russias-interest-syria-not-assad>
- [25] Staff, N. (2011). The Arab Spring Country by Country. Retrieved October 17, 2017, from The National: <https://www.thenational.ae/world/the-arab-spring-country-by-country-1.401358>
- [26] Stent, A. (2016). Putin's Power in Syria: How to Respond to Russia intervention. Foreign Affairs , 108-109.
- [27] Talukdar, I. (2016). Russia's Strategic Interest in Syria. Indian Council of World Affairs , 8.

Roles of Religious Leaders for Behavioral Change in Women and Child Health (Case Study of Roles of Muhammadiyah Aisyiyah Religious Leaders as Agents to Support the Behavioral Change in Maternal Mortality, IVA Screening and Malnutrition in Indonesia)

Dr. Tri Hastuti Nur R

Secretary of Aisyiyah National Board Member and Lecturer in Muhammadiyah University

M.Si, Hajar Nur S, M.Hum

Research and Development Board in Aisyiyah, Project Officer of MAMPU program, cooperation Aisyiyah and DFAT
Mega Ardina, M.Sc.

Lecturer of Aisyiyah University in Yogyakarta

Abstract- Referring to Indonesia government data, there are still many problems related to fulfillment of women's health and nutrition rights. The problems are maternal mortality rates reaching 305 per 100,000 live births, cervical and breast cancers which mostly cause female deaths from cancer and the prevalence of stunting is 37.2%. This fact has shown bad record of the government services in improving quality of women's health in Indonesia because maternal and child health is a basic right of citizens and an indicator in achieving of Human Development Index. Maternal and child health is an important issue at international level refer to SDGs goals, targets and indicators of achievement until 2030; and must be a guideline for the government in development programs at national and regional levels.

However, efforts to improve maternal and child health in Indonesia has to meet various problems, such as political aspects (government policy), economy, availability and quality of services, culture and religious interpretation. In Indonesian context, cultural factors and interpretations of religion are important factors that must be considered in promoting quality of maternal and child health. There are still many cultural myths in Indonesia and religious interpretations that constraint fulfillment of women's and children's health rights. Various strategies are therefore carried out by Aisyiyah as a religious organization that encourage religious leaders who play important role in maternal and child health behavior changes.

This research uses descriptive qualitative method with case study approach. The results showed that in midst of the development of information technology, religious leaders and religious organizations have an important role in encouraging changes in maternal and child health behavior through interpretation of religious teachings about position of women, maternal health, and child health based on a progressive view of Islam. When deciding changes in maternal and child health behavior, religious leaders are still a reference even though information sources from various media can be accessed.

Keywords: women and children health, religious leader, progressive values of Islam.

1. Introduction

Women and child health still became a serious concern in Indonesia even when the age of this nation reached 43 years. Problems and discussions of maternal and child health such as maternal and infant mortality issued during Indonesian Women's Congress held in 1928, were rolled out as collective concerns. Unfortunately, both of these problems are still emerging today. Based National Survey on 2015, Maternal Mortality Rate (MMR) in Indonesia is 305 per 100,000 live births. MMR (AKI) problem also contributed to achievement of Millennium Development Goals (MDGs) in Indonesia in 2015 which targeted a reduction in MMR to 102 per 100,000 live births; whereas objective of Sustainable Development Goals (SDGs), on goal 3, target 3.1 stated that in 2030 the ratio of maternal mortality will decrease up to less than 70 per 100,000 live births.

Cervical and breast cancer have been the major causes for death of women related to cancer although they are included in cancers that have greater chance to recover if detected earlier. Unfortunately, 70% of women with both cancers are diagnosed at final stage so that there is only a little chance for them to recover and a greater possibility to die. Referring to target 3.4, SDGs has mandated on 2030 to reduce up to a third of the mortality rate from non-contagious diseases through prevention, treatment, mental health and welfare. About children's health, stunting problems in Indonesia are stunting prevalence in 37.2% (Basic Health Research, 2013) and based on Basic Health Research on 2017 (Risikesdas) the stunting rate in Indonesia is 30.8% percent higher than WHO minimum standard which is 20%.

There are several factors that cause the high number of maternal and child health problems, including political factors like policies and budget allocations as well

as gap between policy and implementation. Other factor is economic factor related to problem of affordability; educational factors related to lack of public education on maternal and child health to various stakeholders. Cultural factors involve both cultural myths surrounding maternal and child health that actually do not support the achievement of maternal and child health efforts and the interpretation of religious teachings that do not favor maternal and child health. These various factors are intertwined so that efforts to improve maternal health are constrained due to complex problems. Unfortunately cultural factors rarely appear in analysis of problems that are useful for planning maternal and child health development programs. As a result, efforts to improve health of mothers are struggling in political and economic sectors, while cultural factors are still not a priority even though they play an important role in making decisions on changes in maternal and child health. In addition, stakeholders related to cultural factors such as traditional leaders, religious leaders, and families have not been involved in efforts to improve maternal and child health. To contribute in improving women and children health quality, 'Aisyiyah as Islamic mass organization in Indonesia has developed some strategy to involve religious leaders as opinion leaders in their communities to support behavior change of health. Aisyiyah has made to train and educate those religious leaders to improve their competences and reconstruct their perspectives in a new vision, in a new paradigm with Islamic progressive teaching.

2. Research Question

How are the roles of religious leaders in encouraging the behavior change in dealing with women and children health in Indonesia?

3. Theoretical Framework

3.1. Roles of Opinion Leader for Behavior Change

Opinion leaders in community play a dominant role in accelerating achievement of behavior change including health issues. Many programs in community rely on roles and strength of opinion leaders in communication networks to promote health issues. Based on theory of diffusion innovation, in addition to mass communication, dissemination through interpersonal communication is an important part of adoption of new behaviors. Innovation diffusion theory was introduced by Everett M Rogers. According to Rogers (1983: 20-22), decision-making process of an idea (innovation) begins with first knowledge of an innovation by forming an attitude towards idea (innovation), until it decides to reject or accept idea and then implement idea (innovation). Social structure is one of important factors that must be considered in a process of diffusion of innovation. Related to this social structure, Rogers (1983: 24-29) mentions existence of four factors that influence process of innovation decisions. The four factors are social structure, system norms, role of leaders and agents of change. Social structure can facilitate or inhibit diffusion of innovation in a social system.

Referring to factors that influence diffusion of this innovation, opinion leaders are agents of change for

adoption of innovation (ideas) if they agree to new idea. Opinion leaders are certain people who are able to influence attitudes of others informally in a social system whose role is to be adopter or to be an opponent. They act as a model where their behavior (both supporting or opposing) is followed by their followers. Some cases of opinion leaders successfully encouraged changes in behavior (new ideas) Valente and Davis (1999: 57), among others in case of lowering number of unsafe sex and reducing incidence of childbirth by the cesarean method. Opinion leaders are people who are able to influence the attitudes of others to receive an innovation. Opinion leaders have characteristics such as (1) having a high level of formal education (2) having good socio-economic status (3) innovative and easy to accept new ideas (4) interacting more with the media compared to other community members (5) have a big concern for the community members (6) have a broad level of insight and (6) have a high level of participation in community activities. Related to the characteristics an opinion leader, Corey, L. (1971) cited by Chaudhry and Irshad (2013) asserted that character of opinion leader can be distinguished based on income and level of work; including more intensive interaction with media and having more knowledge about an issue. In Indonesian context, who is called opinion leader? Based on characteristics mentioned above, opinion leaders in Indonesia include community leaders in the fields of health and education, traditional leaders, religious leaders, youth leaders (youth), NGO activists and women leaders. They have an important role in encouraging changes in health behavior, especially in their community because they are role models and role models in their communities. Even though they do not have formal and bureaucratic positions in government, their opinions are heard by public; and at the same time become a place for community to obtain important information related to government policies. They have a network of communication in their communities or communities related to various issues that are developing well in the world, national and local.

As for forms that opinion leaders do to encourage behavior change or accept a new idea (innovation), Valente and Davis (1999: 57) explain some forms of peer influence, peer educating, interpersonal counseling, outreach and peer networks. Still referring to Valente and Davis (1999: 63) more explained that role of opinion leaders function effectively in diffusion process of innovation, there are 3 important things that must be considered, namely (1) the process of forming opinion leaders. This process will determine the success of leader opinion as an agent of change, whether it is trusted by community members or not which will have an impact on effectiveness in influencing behavior change. (2) Location of training, which is formal or informal (3) Learning process are static or dynamic.

3.1. Religious Interpretation and Culture Factors in Health

Rogers (2003) refer to Katz (1961) explained that diffusion of innovations must pay attention to social structure of its potential adopter (community). This social

structure is one of them with a system norm factors which can be an inhibiting factor for accepting a new idea. A new idea (innovation) relates to degree of conformity of innovation with value or trust of the community in a social system. Culture and religion as a social system, become a very important factor in influencing health behavior of a person both willing to do and not willing to make behavioral changes in several communities. Several studies in field of health behavior change have found a fairly strong relationship between changes in health behavior with cultural factors and interpretations of religion, including in Indonesia. One of the results of research that shows this phenomenon is a study conducted by Yildiz S, Toruner EK, Altay N (2018: 6-10) about cultural factors that affect health, asserting that health is influenced by several factors, namely cultural factors, biological factors and the environment. Health behavior is result of belief about health that comes from culture in which individual originates. Practices of family culture are closely related to the cultural practices of other family members. In particular, this study explains that children learn about the beliefs, values, skills and knowledge of their family and culture. Culture plays an important role in socialization and development of children. Cultural background holds a very important role in the social and emotional development of children. Traditions, cultural values, attitudes and behaviors in society and family structures will be socialized from generation to generation. This culture is closely related to how they view the concept of sickness, the concept of health, the concept of healthy food and the concept of healthy and clean behavior. Likewise with behavioral problems related to stunting, exclusive breastfeeding and IVA test screening were influenced by many factors such as belief, values, abilities, knowledge and skills as well as individual cultures or their families.

Generally Unicef (2004), made categories of malnutrition cases in three categories:

- (1) immediate causes are insufficient diet, poor breastfeeding practices, early weaning, food taboos and personal choices related to diet
- (2) underlying causes are house hold food security, inadequate children care, women low education/information levels, unhealthy environments, social and religious norms, gender equity and maternal access to education
- (3) basic causes are poor availability and control of resources i.e. political, social, ideological and economy

Based on above categories, religious norms, gender equity and social norms are important factors that cause malnutrition in children. Associated with breastfeeding which greatly affects stunting in children shows that in some countries there is a cultural understanding that has an impact on stunting and is against health; for example an understanding of colostrum which has a high nutrient content but in some cultures it is not recommended to drink it to newborns and taboo on some nutritious foods for both women and children.

Maschinot (2008) highlighted that food consumption remains influenced by the existing socio-cultural factors that affect food behaviour along with customary systems of food sharing within households, cultural attitudes towards various foods, methods of food preparation and child-rearing practices. Further, as well as religion factor some literatures demonstrates that religion is a major factor influencing food and health-seeking behaviours of mothers (Christian *et al.*, 2006; Shakya, 2006). Idler (2014) in *Religion as A Social Determinant of Public Health* book stressing that religion already intensive to study by scholar related with public health. Role the faith traditions play in determining indicators of public health such as infant mortality, life expectancy and cause specific deaths. Religious leaders were frequently in the forefront of public health reform movements, often bringing to effort strong social justice orientation that linked economic and living conditions to health.

4. Research Method

This research method is descriptive qualitative. Data collecting are document, in depth interview and observation. Data document as like monthly report and three month report including pictures. Depth interview was conducted to informants as like religious leaders, program officers and Aisyiyah board members.

5. Finding and Discussion

5.1. Myths and Interpretation of Religion Teaching

Based on the program report when 'Aisyiyah conducted maternal and child health assistance, education and empowerment in community and during the depth interviewed with religious leaders, there are many myths surrounding health of mothers and children that are believed by the community in various regions in Indonesia. In some areas such as West Kalimantan, Belitung, Sulawesi, and some areas in Java, pregnant and lactating women are not permitted to eat fishy-smelling foods because of the fears that children will experience itching due to eating scaly fish. While, in fact, most fishy-smelling foods such as river and sea fish and eggs are important sources of animal protein to consume by pregnant and lactating mothers in order to meet the nutritional needs of fetuses and breastfed babies. Even lack of sources of animal protein can have an impact on cases of malnutrition and stunting.

In addition, there are also several other myths, such as the prohibition for a husband to slaughter or cut animals because it is said that it may cause disability to the baby conceived by his wife; necessity to open doors and windows during childbirth; intercourse prohibition when a wife is pregnant because it can cause disability to the fetus; obligation to place kitchen spices, leaves, charcoal and lime on doorstep and rooms as a repellent; prohibition of cutting cloth when pregnant because it will cause cleft lip; prohibition on eating squid because it can cause babies to have black skin; prohibition for pregnant women to eat food that has not been maintained and prayed by local religious leaders; belief that having many children will bring a lot of sustenance; necessity of getting a help of a *dukun* (traditional health services) while giving birth which may cause a higher risk of maternal death because it is carried

out at home with limited facilities and immediate handling difficulties if there are problems in labor; prohibition of eating sour and spicy food, necessity to grill or roast food before being consumed, disallowance of eating any kind of food which contains coconut milk in spite of the fact that it may boost breast milk production, strong recommendation of drinking herbal medicine; performing facial treatment with a splash of water boiled with betel leaves or aromatic ginger, rice dregs wrapped in cloth and heated then smeared into the mother's vagina after giving birth.

These myths have flourished in cultural traditions of many regions in Indonesia and are still practiced in a daily basis until today. Pregnancy and childbirth are great events in various cultures because they are related to regeneration process that must be maintained, so many myths in the forms of prohibitions or suggestions have been going along with maternal pregnancy. Unfortunately, most of these myths have become obstacles in improving maternal and child health. However, women who are mostly placed as secondary citizens in various cultures find it difficult to reject this bunch of rules regarding pregnancy. The existence of power relations between women and men and their families in the environment is an obstacle for women to make decisions on their own health as well as their children's. In the patriarchy culture, even if a woman is the one who owns her body, she does not have any control or power over it. Many culture practices today indeed put women as object.

In addition to myths that have grown in various cultures, there are interpretations of religious teachings that constraint improvement of maternal and child health. Some of these interpretations say that women are created from Adam's ribs so they are considered as weak creatures and should be inferior compared to men; interpretation of female circumcision, interpretation of maternal deaths during pregnancy and childbirth is martyrdom/*saheed* mortality. The interpretation of the recommendation to have many children and the prohibition on killing children for fear of poverty is used as a basis for prohibiting family planning; prohibition on carrying out early detection of cervical cancer due to opening *aurah/genitals*; prohibition of wives from refusing requests for sexual intercourse by husbands because they will be cursed by angels; interpretation of child marriage; up to the ban on immunization.

The interpretation of religious and cultural teachings have been put women in a position below men and it has an impact on maternal and child health (unequal relation). For example, the right of family decision is in the hands of a husband or brother so that women cannot make decisions even related to health of their bodies and children. As a result, when there is an emergency of pregnancy and childbirth experienced by mother and requires immediate referral to a health facility that is far from her residence, mother cannot make decisions and wait for decisions from her husband or family so that they can be life-threatening. It means that handling such emergency cases cannot be done immediately. This condition is exacerbated by interpretation of martyrdom/*saheed* mortality for mothers who die from pregnancy and childbirth to appease the

family for death of mother, but it is not understood as a necessity to make the most of maternal health as a form of struggle so that pregnancy and childbirth run smoothly without having to lead to death.

The religious interpretation of ability to get married at early age also contributes to high maternal mortality rate when childbirth due to immaturity of reproductive organs in girls to carry out sexual and reproductive roles. In addition to the impact of maternal death during childbirth, unpreparedness of reproductive organs in girls can also cause cervical cancer. Based on MoH the percentage of children marriage at age 15 to 19 years old reaches 23.9% in Indonesia. Around the world, Indonesia occupies the seventh position among countries with the largest case of child marriage. The impact of children marriage towards maternal mortality is shown at the percentage of mothers who died during childbirth based on their ages. There is about 92% of Indonesian mothers who died while giving birth to their first child and aged less than 20 years.

Muhammadiyah does not advocate marriage solely based on age problem. Marriage as a very strong agreement between men and women as husband and wife that requires responsibility in fulfilling it and demands physical, psychological, social, economic, and spiritual maturity. In Surah An-Nuur verse 32 which is used as normative basis of marriage, there is a word of righteousness which is interpreted as a person who already has the ability and maturity so that children as profiles who do not have ability and maturity are not appropriate to get married. Regarding the hadith that reveals the age of Aisyah when she was married to Muhammad, Muhammadiyah has conducted a comprehensive study from its historical aspect.

Furthermore, Muhammadiyah has made an effort to study the hadith concerning how old 'Aisyah was when she got married to Muhammad, based on the sanad (the citations used to verify the legitimacy of a hadith), and found that the hadith was told by Hisyam bin 'Urwah when he was settling in Iraq at the age of 71. It was said that every remark that Hisyam made was trustworthy except when he was settling in Iraq including the moment when he narrated the hadith. Further, the hadith was also examined based on historical, sosio-anthropological, *ahwal asy-syakhshiyah and tarikh tasyri'* aspects and, thus, by these considerations, the hadith is not appropriate to use as a reference in legalizing child marriage in Islam.

The religious teachings on *aurah/genitals* in women may constraint maternal health from the danger of cervical and breast cancer. In some areas both in Java, Sulawesi, and Kalimantan, cadre of 'Aisyiyah found women who cannot carry out IVA or pap smear examinations as an effort to detect cervical cancer because they are not allowed by their husbands for reasons of having to open the *aurah*. While early detection of cancer is important so that if cancer is detected at an early stage, there is a high chance of recovery. In Muhammadiyah perspective, opening *aurat* for purpose of medical examination is permitted by using the *istihsan* method in its legal stipulation. With the use of *istihsan* method, something that is prohibited is permissible for *syar'i* reasons

which are aimed at eliminating burden and difficulty. This is in accordance with *fiqhiyyah* rule that *mudharat*/falsehood must be eliminated, falsehood allows restrictions, and something that is determined because of an emergency. Based on these rules, opening aurah for conducting health checks such as installation of contraceptives and early detection of cervical cancer is allowed to prevent falsehood are cervical cancer and breast cancer which can cause death in women.

There are also interpretations of religious teachings about encouragement to have many off spring to strengthen *ummah* and prohibition on fear of poverty due to extent of *rizq*. The impact of family planning by having a large number of offspring in accordance with their abilities is deemed deviant or not in accordance with Islamic teachings. In Muhammadiyah perspectives, family planning by regulating pregnancy are aimed at improving quality of life of families, especially children. This is in line with several verses in the Qur'an such as An-Nisa (4): 9, an-Nahl (16): 72, and ar-Rum (30): 21 which indicates the importance of improving the quality of family life, "*And let those (executors and guardians) have the same fear in their minds as they would have for their own, if they had left weak offspring behind. So let them fear Allah and speak right words.*" Family planning with pregnancy arrangements is in line with Islamic values that teach:

1) the need to avoid worrying about the safety of life and the health of the mother because of pregnancy and childbirth.

2) avoiding concerns over religious safety because of the narrowness of livelihood factors such as worries in carrying out things that damage the faith (aqidah), carry out illegal (haram) acts because they are driven by children's interests,

3) the need to avoid worrying about children's health and education because the birth distance is too tight.

Culture and understanding of religion that places women as second creatures makes domestic roles and nurturing is obligation of women. This turned out to also influence problem of nutrition in children and stunting. The multiple burdens experienced by women due to lack of the role of family, especially husband in the care and management of the household, led to view that the fulfillment of family nutrition and household management was a matter for women alone. As a result, women find it difficult to provide balanced nutrition for children, among others, because time is taken to care for children and do housework. In addition, unequal relations between husband and wife cause women not to have bargaining power in communicating nutritional needs of children while not a little money is used to spend cigarettes. Women also have difficulty communicating to husbands to share the role of care and management of the household. Likewise, the interpretation of religious teachings by giving dates or known as *tahnik* or honey for babies influences fulfillment of exclusive breastfeeding; whereas, exclusive breastfeeding requires only breastfeeding for the first 6 months.

But on the other hand, there are many religious teachings in this case Islam that support the provision of the best nutrition for babies, such as breastfeeding for two years, ability to breastfeed other mothers in certain

situations and teachings about *halal* and *thayyib* food. The word *thayyib* as mentioned in several verses of the Qur'an is a criterion of food and beverage consumption in Islam. The actual use of the word *thayyib* can be interpreted as good food, which is not only *halal* but also a healthy, nutritious and beneficial food for life. In addition, in Islamic history, there was a model from Umar who showed a high political commitment to maternal and child health, with the policy of providing compensation for newborn babies and completion of weaning as a form of support for breastfeeding.

5.2. Religious Leaders And Religious Organizations as Agents of Change

Recognizing the importance of cultural approaches and religious interpretations in addressing maternal and child health problems, Muhammadiyah and 'Aisyiyah as Islamic Progressive organizations use a religious approach by involving religious leaders in efforts to improve maternal and child health. 'Aisyiyah implements some strategies to strengthen women's leadership, empowerment in community, and advocacy in improving maternal and child health.



(National Meeting of Religious Leader To Support Women and Child Health, 2018, Aisyiyah Documentation)

Strengthening women's leadership in community is an important strategy in improving maternal and child health. As a women's movement, 'Aisyiyah believes that women have a strategic role in changing society, including in maternal and child health. It is also based on Islamic values that underlies existences of 'Aisyiyah movement, namely Islamic teachings on equality of good deeds by men and women. The Quran Surah an-Nahl verse 97, "*Whoever does righteousness, whether male or female, while he is a believer, We will surely cause him to live a good life, and We will surely give them their reward [in the Hereafter] according to the best of what they used to do.*"

Based on the experiences of community empowerment that has been carried out by 'Aisyiyah, women's leadership is a key to change initiatives and their sustainability. Therefore, 'Aisyiyah views efforts to improve women's leadership at community level. Cadres of 'Aisyiyah are vanguard in moving community. They have roles to mobilize community called Balai Sakinah 'Aisyiyah; to establish cooperation or partnership with various stakeholders in villages and sub-districts such as religious leaders, community leaders, midwives, health centers, and other village institutions; and to advocate policies and budget allocations at village level and health

service providers, as well as to advocate values to local religious leaders. In carrying out these strategic roles, 'Aisiyiyah has increased capacity of women's leadership, reproductive health paradigms, women's issues and maternal health of children in an Islamic perspective, community empowerment, and advocacy. Capacity building was carried out through training and mentoring by cadres, 'Aisiyiyah leaders, and facilitating teams at sub-district and regional levels. One of the competencies that cadres need to have is a persuasive approach to behavior change and communication and collaboration with various multi-related parties including religious leaders.



(Religious Meeting in Sambas District, 2018, Aisiyiyah Documentation)

Empowerment in community is done through the Balai Sakinah 'Aisiyiyah group, which is a group of 15-20 female *dhu'afa mustadh'afin*. BSA is the center of some group activities, as like education, complaints, counseling, and economic empowerment in accordance with needs of group members. At BSA, 'Aisiyiyah also encourages BSA cadres and members to have competences to speak in public and communicate equally with their partners. This is important because it is a provision of women's leadership that requires skill and competence to convey women's aspirations in front of public and skill to communicate the needs of women and children. Regarding stunting prevention, 'Aisiyiyah initiated Rumah Gizi (Nutrition House) at BSA as an effort to realize the improvement of nutritional status and stunting prevention and to develop sovereignty and community-based food security. The term 'Nutrition House' does not refer to the existence of a building but to the efforts in improving nutrition and preventing stunting which is based on some activities. There are 6 home nutrition activities such as nutrition education, nutrition garden management, practice of processing nutritious local food, breastfeeding counseling, nutritional counseling, supplementary feeding and sanitation.

At BSA, education on maternal and child health is also carried out in Islamic progressive perspective by involving local religious leaders both men and women. In addition, 'Aisiyiyah invited community leaders and religious leaders to conduct family education such as husbands and grandmothers who had an important role in supporting achievement of maternal and child health. Through BSA, 'Aisiyiyah also encourages behavioral changes such as Exclusive Breastfeeding and breastfeeding during 2 years, family planning, screening of cervical and breast cancer, and fulfillment of nutrition to prevent stunting. To support of behavioral changes, 'Aisiyiyah also involves religious leaders and community leaders so that the community is increasingly convinced because these behavioral changes

are also in accordance with teachings of religion they believe in. When there are obstacles such as when women didn't allow to carry out of screening test by their husbands because of their husbands worried that the wives' genitals are seen by health workers, cadres of 'Aisiyiyah also involve community leaders and religious leaders in the process of communicating with families so that women can carry out early detection of cancer checks (screening test). In the process of policy advocacy at the village level, such as advocating village regulations on reproductive health 'Aisiyiyah also involved community leaders and religious leaders who are respected by village government. Thus, village government is willing to issue a policy and allocate a budget because it gets a support from respected influential figures in the village.

As a religious organization that bases its movement on Islamic progressive teaching (Islam Berkemajuan) and alignments with poor and vulnerable groups including women and children groups, *da'wah* movements of 'Aisiyiyah in the field of maternal and child health must also be based on these values. Although Islamic teachings contain many aspects of life and teach connection between humans and Allah or known in terms of *hablun minallah* and connection between humans and humans or known in terms *hablun minannaas*, themes of health and nutrition have not been found in many recitations meetings held in any communities.

The efforts of religious approaches and involving religious leaders in improving maternal health are carried out with the following steps, including 1) Preparing material on maternal and child health as well as strategic women's issues in the view of Islamic progressive teaching 2) Conducting Islamic progressive teaching related to women's issues, maternal and child health to religious leaders both women and men on women's issues; 3) Conduct education about maternal and child health in an Islamic perspective in the community both to women, men / husbands, and grandmothers by involving religious leaders; 4) Conduct public education in various media, such as mass media, Friday bulletins, and organization magazines which become references for leaders in *da'wah* in the community, as well as social media both Facebook, Twitter, Instagram and Youtube which are packaged in the form of info graphics, web series, video graphics, live recitation, posts on whatapps group.

When conducting dialogues with religious leaders in 10 districts and refreshment for religious leaders in Magelang, Mempawah, and Sambas districts, it was found that religious leaders delivered more material about *tauhid*, worship, and morals, but rarely delivered health and nutrition material issues from Islamic perspective in recitals (religious forum).

In this case, Aisiyiyah National Board distributed material on reproductive health and nutrition in Islam, religious leaders claimed to need these materials as material to deliver study material because of the lack of materials related to the themes of reproductive health and nutrition in Islam.



(Group discussion at Religious Leaders Workshop in Mamuju, West Sulawesi, 2018)

When Aisyiyah compiles books in reproductive health in Islam and nutrition, 'Aisyiyah also conducted a telephone survey to religious leaders in several districts such as Pangkep, Mempawah, Sambas, Mamuju, Tegal, and Blitar district. When asked about the easiest way to get information and share information, the WhatsApp messaging application is most widely used by religious leaders. While much information is obtained from magazines, television, and WhatsApp messaging applications. While the references are widely used by Muhammadiyah religious leaders -Aisyiyah published by the organization, namely Suara Muhammadiyah, Suara 'Aisyiyah, and books published by Muhammadiyah-'Aisyiyah. In addition, the book is still the choice of religious leaders to assist them when delivering teaching material.

From the survey results', Aisyiyah then compiled a study material book on women's issues, reproductive health and nutrition. In addition to books, 'Aisyiyah also wrote maternal and child health material in the Islamic view progressing in Suara' Aisyiyah and Suara Muhammadiyah magazines which indeed became a lot reference to religious leaders or *muballigh* of 'Aisyiyah Muhammadiyah in da'wah. To expand the range of recitation or dissemination of nutrition from progressive Islam perspective, theme of nutrition and immunization of children becomes da'wah material that 'Aisyiyah brings through social media, both in form of info graphics, video graphics, vlogs, and live recitation/*pengajian*.

In the community, 'Aisyiyah cooperates with local religious leaders both men and women to socialize about health and nutrition in a progressive view of Islam. 'Aisyiyah cooperates with female religious leaders or *muballighat* because female religious leaders have closeness and concern for the issue. 'Aisyiyah as a da'wah movement that echoes the equality of virtuous deeds of men and women so that it has a distinctiveness that is the number of *muballighat* or female religious leaders. Historically, 'Aisyiyah also has a concern in preaching in field of health,

such as the baby show activities or Baby Congress held 'Aisyiyah at the national level to the village level in the 1930s.

'Aisyiyah also identified religious leaders to become champions as religious leaders concerned with nutrition. In the Jeruk Legi District of Cilacap Regency, there was a Muhammadiyah figure named Darno, who also became a preacher in the local environment. He also manages recitation/*pengajian* which is attended by men and women in the local environment. He conveyed the theme of reproductive health and nutrition after reading the cadre material book 'Aisyiyah which belongs to his wife who is also a cadre. According to Darno, these themes are important themes conveyed in the recitation because they are basic needs of citizens and in fact there are many Islamic teachings that cover the theme of nutrition and need to be conveyed more widely. By knowing Islamic teachings about ASI for example, Darno revealed that it would increase the motivation of citizens to practice healthy living.

Conclusion

Efforts to improve maternal and child health in Indonesia have to meet various problems which are political aspects (government policy), economy, availability and quality of services, culture and religious interpretation. In Indonesian context, cultural factors and interpretations of religion are important factors that must be considered in promoting quality of maternal and child health. There are still many myths in culture in Indonesia and religious interpretations that constraint fulfillment of women's and children's health rights. Recognizing the importance of cultural approaches and religious interpretations in addressing maternal and child health problems, Muhammadiyah and 'Aisyiyah as Islamic progressive organizations have made use of a religious approach by involving religious leaders in their efforts to improve maternal and child health. To support the behavioral changes, 'Aisyiyah also involves religious leaders and community leaders so community is increasingly convinced because these behavioral changes are also in accordance with teachings of the religion they believe in.

Bibliography

- Buletin Sakinah, *Pernikahan Anak Tidak Dianjurkan dalam Islam*, Pimpinan Pusat 'Aisyiah, September, 2018
- Buku Materi Edukasi "*Meningkatkan Kesadaran Hak-hak Kesehatan Reproduksi Perempuan*", Pimpinan Pusat 'Aisyiyah, 2014
- Ellen, L Idler (2014) *Religion as a Social Determinant of Public Health*, Oxford University Press
- Hasil Assessment Lembaga Penelitian dan Pengembangan PP 'Aisyiyah di Banten Tahun 2011
- Hasil Assessment 'Aisyiyah tentang Perubahan Perilaku Kesehatan Reproduksi dan Gizi untuk Peningkatan Derajat Kesehatan di Bantaeng, Lamongan, Ngawi, dan Cilacap, Tahun 2013
- Hasil Assessment 'Aisyiyah tentang Perubahan Perilaku Kesehatan Reproduksi dan Gizi untuk Peningkatan Derajat Kesehatan di Pangkep, Takalar, Blitar, Cianjur, Cirebon, Tahun 2014

- Hasil Assessment 'Aisyiyah tentang Perubahan Perilaku Kesehatan Reproduksi dan Gizi untuk Peningkatan Derajat Kesehatan di Kab. Belitung, Mempawah, Sambas, Tahun 2015
- Linda M. Chatters, (2000), *Religion and Health : Public Health Research and Practice*, School of Public Health, University of Michigan
- Maschinot (2008), *The Changing Face of US : The Influence Culture on Child Development*, Washington DC, Zero to Three
- Pedoman Penyusunan Rencana Aksi SDGs, Kementerian Perencanaan Pembangunan Nasional
- Riset Kesehatan Dasar 2013, Kementerian Kesehatan Republik Indonesia
- Riset Kesehatan Dasar 2018, Kementerian Kesehatan Republik Indonesia
- Rogers, Everett, (2003). *Diffusion of Innovations*, The Free Press, Mac Millan Publishing, New York
- Sztompka, Piotr (2008), *Sosiologi Perubahan Sosial* , Jakarta, Prenada.
- Shahid Ali Chaudhry, Shahid Ali and Irshad Wasee, *Opinion Leadership and Its Role in Buyer Decision Making*, Academy of Contemporary Research Journal V II (I), 16-23, ISSN: 2305-865X, 2013
- Thomas W Valente, Rebecca L Davis. (1999). *Accelerating of Diffusion Innovation Using Opinion Leader*, Annal APPSS.

Digital Literacy Movement and the Development of Digital Literacy Framework in Indonesia

Taufiqur Rahman

Department of Communication
Faculty of Social and Political Sciences
Universitas Muhammadiyah Yogyakarta

Abstract - Digital literacy is a key element in the development of civilized communication in the digital era. The concept of digital literacy can be interpreted differently, but in general include many important skills needed in facing the fast development of information and communication technology in the digital society. More specifically, UNESCO defined digital literacy as the ability to access, manage, understand, integrate, communicate, evaluate and create information safely and appropriately through digital devices and networked technologies for participation in economic and social life. This definition suggests the importance of digital literacy in our daily life today. Many countries have developed specific initiatives to face the challenges of digital society. Digital literacy movement in Indonesia has been initiated in 2017 by the ministry of communication and information in cooperation with many elements of civil society. This initiative is a good start and should be followed by more systematic efforts to develop a comprehensive and measurable digital literacy framework to improve the quality of digital literacy in Indonesia. This paper asks the question of how digital literacy movement in Indonesia has contributed to the development of a systematic digital literacy framework which can be used as a guidance for the future development of digital literacy programs in Indonesia.

Keywords: digital literacy, digital competence, framework, Indonesia

Introduction

One hope of the presence of internet technology is its ability to provide democratic means of expressing individual identity or collective identity. The democratic face of the internet can be seen from its character that tends to be decentralized, anonymous and has a high endurance (Klotz, 2004). In a democratic country, the internet has a strategic role because of its ability to provide efficient outlets to support other communication media. In an authoritarian country, the internet has a role as an alternative media to fight the domination of public space by the authorities. The internet in general has advantages over conventional media with its ability to deliver more interactive information exchanges, facilitate vertical and horizontal communication, relatively non-mediated communication processes, low costs, high communication speeds, and lack of limits and sensors (Hague & Loader, 1999; Bentivegna, 2006; Jenkins at al, 2009; Harper, 2011).

The potential for conviviality presented by the internet is increasingly felt when the development of technology increasingly leads to the freedom of users to create, modify and share information according to their respective need

(user-generated content). The culture of participation can be interpreted as a culture that makes every individual contribution have meaning, allows small barriers to artistic expression and civic involvement, strong support for creating and sharing copyrighted works and mentorship opportunities for newcomers to learn from the experts (Jenkins et al ., 2009). The culture of participation also contributes to the emergence of diversity which has been hidden in the private space to emerge into the public space. Globalization of information in the digital era has made multicultural society a necessity and is no longer a unique phenomenon in just a few places. As Manuel Castells (2010: xxxvi) argues that globalization does not facilitate the emergence of global culture but instead requires us to learn to share and accept diversity openly in the public space.

The presence of the internet also facilitated the development of a new communication era, which Manuel Castells (2013) called the era of mass-self communication. Submission of information on the internet can be categorized as a mass communication activity because this activity has the potential to reach a broad audience globally such as when we upload videos on Youtube, or deliver messages through mailing lists or groups on social media. At the same time, the message we convey through the internet can be referred to as individual communication because we create the message ourselves, we can also choose the type of audience we want to go to and as part the audience we can also selectively choose the message we will access. The emergence of this new era of individual mass communication presents several challenges that must be anticipated to build a culture of civilized communication.

Internet and the euphoria of democracy

At the beginning of the development of the internet, the potential for participation has not yet been felt. Early generation of internet users still tend to get used to the culture of passive reception in the era of mass media so they have not realized the potential to become active participants in this new media. The introduction of applications such as weblogs, micro blogs and other forms of social media that are increasingly user-friendly and allow users to play a role in content creation strongly supports the emergence of a culture of participation in the use of the internet. The development of internet technology facilitated the transition from a culture of passive reception in the era of mass media

in the late 20th century to a culture of active participation in the early 21st century (Flew, 2009).

This cultural transition in practice gave rise to euphoria for internet users so that many internet users were trapped in the concept of inappropriate freedom. Freedom of expression that should be used responsibly, often changes into freedom to hate and freedom to distort information (Lim, 2017). Freedom to do criticism can turn into hate speech or hate spinning (Gaorge, 2017).

The high growth of social media users in Indonesia has significantly contributed to the development of a culture of participation in internet use and the growth of a new form of 'social connection' in the virtual world (Jenkins et al 2009). This social connection is built through interactions that are built through networked publics as defined by danah boyd (2011). The interaction of internet users through their respective social media accounts has created a networked public, especially with the presence of features such as profiles, friend lists, comment rooms and updated information updates (boyd, 2011: 43). Some popular social media platforms such as Facebook, Twitter and Instagram offer features that users can use to build social connections and build new imaginary communities beyond geographical boundaries.

These new imaginary communities are created consciously or unconsciously through a personalization process created and facilitated by the creators of social media platforms. These communities are often built in a limited circle of friends and followers. The phenomenon of limited social connections built by these communities raises fears of social alienation because of the emergence of strong tendencies in selectively filtering information and creating filter bubbles or algorithmic enclaves in certain networks that make it impossible the inclusion of information and opinions that conflict with the views of most network members (Pariser, 2011; Lim, 2017).

The need of digital literacy framework

Digital literacy is a key word in the effort to build civilized communication in the digital era. The concept of digital literacy can be interpreted in a variety of ways, but simply can be defined as the ability needed by every individual to be able to live, learn and work in a digital society (JISC, 2014). UNESCO formulates the definition of digital literacy more specifically as ‘the ability to access, manage, understand, integrate, communicate, evaluate and create information safely and appropriately through digital devices and networked technologies for economic and social life participation’ (UNESCO, 2018). The definition stated above illustrates how wide the scope of digital literacy or new terms is currently more often used, namely digital competencies that must be owned by every individual to be able to live well in the digital era.

Various efforts have been initiated to make a systematic formula to identify important elements in digital literacy /

competencies that must be possessed by every individual in a digital society. Several countries have implemented digital literacy frameworks through formal and informal sectors (Hermanadi and Daniswara, ...). One of the efforts which can be regarded as a best practice initiative in developing a comprehensive digital literacy framework was carried out by the European Union Joint Research Center which developed the DigComp concept (Digital Competence Framework for Citizens). The study and development of this framework has been started since 2005 and continues to be updated until now. In this framework 21 types of digital competencies were identified which are grouped into 5 areas of competence that individuals must have in digital societies, namely: 1) Literacy of information and data; 2) Communication and collaboration; 3) Creation of digital content; 4) Safety; and 5) Problem solving as can be seen in the following table:

Table 1. DigComp’s Digital Competence Framework

Competence area	Competences
1. Information and data literacy	1.1. Browsing, searching and filtering data, information and digital content 1.2. Evaluating data, information and digital content 1.3. Managing data, information and digital content
2. Communication and collaboration	2.1. Interacting through digital technologies 2.2. Sharing through digital technologies 2.3. Engaging in citizenship through digital technologies 2.4. Collaboration through digital technologies 2.5. Netiquette 2.6. Managing digital identity
3. Digital content creation	3.1. Developing digital content 3.2. Integrating and re-elaborating digital content 3.3. Copyright and licences 3.4. Programming
4. Safety	4.1. Protecting devices 4.2. Protecting personal data and privacy 4.3. Protecting health and well-being 4.4. Protecting the environment
5. Problem solving	5.1. Solving technical problems 5.2. Identifying needs and technological responses 5.3. Creatively using digital technologies 5.4. Identifying digital competence gaps

Source: Carretero et al., 2017

The competencies that have been identified are then further divided into eight levels of ability from beginner level to high specialist level (Carretero et al., 2017).

Another framework, for example, was developed by the Joint Information Systems Committee (JISC), a non-governmental organization in the UK by identifying 7 important elements of digital literacy, namely: 1) Information literacy; 2) Media literacy; 3) Communication and collaboration; 4) Digital science; 5) Career and identity management; 6) Learning skills; and 7) Information and communication technology literacy (JISC, 2014). Information literacy includes the ability to search, interpret, evaluate, manage and share information. Media literacy includes the ability to read critically and produce academic and professional communication content in various media. Communication and collaboration include the ability to participate in digital networks for the purpose of learning and researching. The aspects of digital science include the ability to participate in academic, professional and research practices that depend on digital systems. Career and identity management includes the ability to manage the digital reputation of online identity. Learning skills include the ability to learn and effectively in a technology-rich environment, both in formal and informal learning environments. Whereas information and communication technology literacy include the ability to adopt, adapt and use digital equipment, applications or services.

In addition to the two frameworks above there is another new framework developed by the DQ Institute, a global initiative that focuses on developing a new type of intelligence called the Digital Intelligence Quotient (DQ). According to Yuhyun Park (2019), founder of the DQ Institute, the era of the industrial revolution 4.0 requires a new type of intelligence to complement the shortcomings of Intelligence Quotient (IQ) born in the era of the industrial revolution 2.0 and Emotional Intelligence Quotient (EQ) born in the 3.0 industrial revolution era. Park (2019) describes EQ as a comprehensive digital competency unit that is rooted in individual universal moral values that can be used to use, control and create technology for the advancement of humanity. In its development, DQ is grouped in eight areas, namely: 1) Digital identity; 2) Digital use; 3) Digital safety; 4) Digital security; 5) Digital emotional intelligence; 6) Digital communication; 7) Digital literacy; and 8) Digital rights. Details of the eight areas can be seen in the following table:

Table 2. Eight areas of Digital Quotient

Area	Competence
Digital Identity	The ability to build a wholesome onl offline identity
Digital use	The ability to use technology in a balanced, healthy, and civic way
Digital safety	The ability to understand, mitigate and manage various cyber-risks through safe, responsible, and ethical use of technology
Digital security	The ability to detect, avoid, and manage different levels of cyber threats to protect data, devices, networks, and systems

Digital emotional intelligence	The ability to recognize, navigate, and express emotions in one’s digital intra and inter-personal interactions
Digital communication	The ability to communicate and collaborate with others using technology
Digital literacy	The ability to find, read, evaluate, synthesize, create, adapt, and share information, media, and technology
Digital rights	The ability to understand and uphold human rights and legal rights when using technology

Source: DQ Global Standards Reports (2019)

Efforts to develop a digital literacy framework in Indonesia have also been carried out and need to be appreciated even though it is not comprehensive. The ministry of communication and information has officially launched a national movement called ‘siberkreasi’ (creative cyber movement) in 2017 as a collaboration between government agencies, private corporations, universities, non-governmental organizations and individual public figures. The movement was initiated primarily to counter the thread of negative contents on the internet such as hoaxes, cyberbullying and online radicalism (siberkreasi.id/tentang-siberkreasi/). The movement has been implemented by several programs which include providing digital literacy literatures in the website (literasidigital.id), encouraging public participation for digital literacy activities (Pandu Digital), enhancing digital literacy through the medium of arts especially batik (Batik Siberkreasi), developing digital literacy through the creation of positive contents (School of Influencer), organizing event for creative sharing opportunities among Indonesian netizen (Netizen Fair) and also providing a space for content creators to share their knowledge an experiences (Kreator Nongkrong).

Siberkreasi is a very good initiative. However, there is still very limited effort to develop a more comprehensive approach in the development of digital literacy. More systematic efforts are needed by the development of a framework which can be used as a guideline to develop nationwide digital literacy programs. For example, there is a digital literacy framework developed by ICT Watch with a focus on three aspects of digital literacy, namely protection, rights and empowerment. Protection aspects include protection of personal data, online security and individual privacy. Aspects of rights include freedom of expression, intellectual property and social activism. While the aspects of empowerment include citizen journalism, entrepreneurship and information ethics (ICT Watch, 2017). This initiative is a good start but still need further elaboration in order to be regarded as a comprehensive framework.

Conclusion

More serious efforts to develop a digital literacy framework in Indonesia are still very much needed as an effort to build

a more civilized digital society. The digital literacy movement launched in 2017 and various initiatives that have been carried out by various elements of society in driving digital literacy must be followed by more systematic efforts in developing a comprehensive and measurable digital literacy framework to improve the quality of digital literacy in the Indonesian community.

[1-global-framework-reference-digital-literacy-skills-2018-en.pdf](#)

Park, Y. (2019) *DQ Global Standards Report*. DQ Institute. Accessed 10 September 2019 from <https://www.dqinstitute.org/wpcontent/uploads/2019/03/DQGlobalStandardsReport2019.pdf>

References

- Bentivegna, S. (2006). Rethinking politics in the world of ICTs. *European Journal of Communication*. 21(3).
- boyd, d. (2011). Social network sites as networked publics: Affordances, dynamics, and implications. In Z. Papacharissi (Ed) *Networked self: identity, community, and culture on social network sites*. New York: Routledge, pp. 39 – 58.
- Carretero, S., Vourikari, R. and Punie, I. (2017). *DigComp 2.1 the digital competence framework for citizens: with eight proficiency levels and examples of use*. Luxembourg: European Union.
- Castells, M. (2010). *The power of identity*, Chichester, England: Wiley-Blackwell.
- Castells, M. (2013). *Communication Power*. Oxford: Oxford University Press.
- ICT Watch. (2017). *Kerangka literasi digital Indonesia*. <http://literasidigital.id/books/kerangka-literasi-digital-indonesia/>
- Flew, T. (2009). Democracy, participation and convergent media: Case studies in contemporary online news journalism in Australia. *Communication, Politics & Culture*, 42 (2), 87--115.
- George, C. (2017). *Pelintiran Kebencian: Rekayasa Ketersinggungan Agama dan Ancamannya bagi Demokrasi*. Ihsan Ali Fauzi dan Irsyad Rafsadie (penyunting). Jakarta: PUSAD Paramadina.
- Hague, B.N., & Loader, B.D. (1999). *Digital democracy: Discourse and decision making in the information age*. Hoboken: Taylor and Francis.
- Harper, T. (2011). *Democracy in the age of new media: The politics of the spectacle*. New York: Peter Lang.
- Jenkins, H., Purushotma, R., Weigel, M., Clinton, K. & Robinson, A.J. (2009). *Confronting the challenges of participatory culture: Media education for the 21st century*. Cambridge: The MIT Press.
- Joint Information Systems Committee. (2014). *Developing Digital Literacies*. <https://www.jisc.ac.uk/guides/developing-digital-literacies>
- Klotz, R.J. (2004). *The politics of internet communication*. Maryland: Rowman and Littlefield Publishers Inc.
- Lim, M. (2017). Freedom to hate: social media, algorithmic enclaves, and the rise of tribal nationalism in Indonesia, *Critical Asian Studies*, 49:3, 411-427.
- Pariser, E. (2011). *The filter bubble: What the internet is hiding from you*. London: Penguin Books.
- UNESCO Institute for Statistics. (2018). *A global framework of reference on digital literacy skills for indicator 4.4.2*. Information Paper No. 51. <http://uis.unesco.org/sites/default/files/documents/ip5>

A Statistical Analysis of the Holy Quran in the Digital Era: Case study of Sura An-Nisa'

Akram M Zeki

Centre for Islamisation

International Islamic University Malaysia

Kuala Lumpur, Malaysia

akramzeki@iiu.edu.my

Abstract—As Muslim believe that, the Holy Qur'an is the words of Allah that is unchangeable and unmodifiable with most accurate in its verses and words, prodigious in its rules, letters and arrangements that cannot be moved forward or backward, no deletions or additions on it. No falsehood can approach it from before or behind it. It is sent down by One Full of Wisdom, worthy of all Praise. Perhaps this paper, can be seen as a great sea of knowledge. The paper shows some statistical analysis on the holy Quran and classify this analysis to few categories by using the computer programs. This paper is focuses on Sura An-Nisa' as a case of study and tries to show some impact of Information and Communication Technology toward serving the Holy Quran.

Keywords—quran and ICT, digital quran, analysis of sura an-nisa', statistics of the quran, digital era, ICT and islam, analysis of the holy quran.

I. INTRODUCTION

The Holy Qur'an contains of 114 Suras (chapters) divided into 30 parts (Juzo'). The total number of its verses (Aayah) are 6236, which contains 77479 words and 324844 letters. There are 87 Meccan Suras (reviled in Macca) and 27 Medinian Suras (reviled in Madina).

This paper highlights the importance of serving the Holy Book of Quran whose endless wonders and knowledge are not enough to create a satisfaction to the scientists. However, many earlier studies (before this work) have addressed this matter by former scholars who inspired us by their works.

The paper divided into two parts, the first part showed some statistical analysis on the holy Quran and classify this analysis to few categories. While the second part of this paper focus on one Sura (chapter) only (Sura An-Nisa') to show some statistical analysis on this Sura which can be applied later on any other Suras (chapters) of the holy Quran. We have classified this analysis into few parts, each one shows different results, as illustrated in the next section. The computer was used for the collection and initial classification of the Quranic databases processes.

II. PREVIOUS STUDIES ABOUT THE STATISTICS OF THE HOLY QURAN

The study of the Holy Qur'an might be one of the most important Islamic Studies in recent times. The study of the meanings of the verses of the Holy Qur'an began during the reign of the revelation to the Prophet (peace be upon him). The studies continued to include the statistics of the words, verses, and Suras of the Holy book, to illustrate the Meccan and Medinian Suras, and to organize them based on the order of descent of the Suras and verses to the Prophet (peace be upon him). Later, dozens of books were written on the jurisprudence

of scientists and scholars majored in the sciences of the Holy Qur'an and its verses. Some of them studied deeply the census of the Quranic verses, the numbers of Suras, and chapters of the Holy Qur'an. Some of them worked hard in the elicitation of secrets of the verses of the book in terms of count, order and other theories that are still under studying and verification.

The efforts of scholars in the field of the Quranic verses statistics began early in the first centuries of Hijrah. The book "البيان في عد آي القرآن" of Abu-Amr Othman bin Saeed Al-Umawi Al-Dani was considered as one of the largest books written in the science of Quranic statistics. The author of this book collected the old books and materials that were previously prepared for this field. This includes the number of verses, setting their heads, the number of words, number of letters and the number of its chapters and their positions. It is worth noting that there are other studies conducted about the order and explanation of the Quranic words, such as: (Kitab Al-Ma'jim Al-Mufahrasa Li Alfath Al-Qur'an Al-Kareem) by the author Abdul Rahman bin Mohammed Al-Hajili, printed in 1421 of Hijrah. The author listed some of the literature and previous books about the order and statement of the Quranic words. Where he referred to some of the following books:

- *Garib Al-Quran*. By: Ibn Abbas, edited by: Ata' bin Abi Rabah (114 of Hijrah).
- *Tafseer Garib Al-Quran*. By: Zaid bin Ali bin Al-Hussain bin Ali bin Abi Talib (120 of Hijrah).
- *Garib Al-Quran*, by: Abi Ja'far bin Ayoub Al-Muqri' (He lived in the second half the second century).
- *Majaz Al-Quran*, by Obaidah mu'mar bin Al-Muthana Al-Timi (210 of Hijrah)

And other books that meant to interpret and study the Garib Al-Qur'an book in terms of its vocabularies and/or words, which exceeded forty books. Then the researcher reviewed some of the books that were written for indexing the Quranic words, including:

- Al-Mu'jam al-mufahras li-alfath al-Qur'an al-kareem, by Mohammed Fouad bin Abdul Baqi (1364 Hijrah).
- *Mu'jam alfath al-Qur'an al-kareem, issued by the Arabic Language Academy in Cairo during the period of 1953 - 1970.*
- *Mu'jam al-alfath wa al-'alam al-quraniah, by Mohammed Ismail bin Ibrahim, the first edition issued in 1961.*

In the field of the inimitability of the Qur'an, Dr. Mohammed Al-Saed Radi Jibril wrote a book entitled "Enaiah al-muslmin bi ibraz wujud al-I'jaz fi al-Qur'an al-kareem". This book addressed a summary of the inimitability of the Holy Qur'an, and narrated the most important studies in this field that were developed by scholars of the early Muslims. Then he divided the inimitability of the Qur'an into seven types, namely: The Qur'an's inimitability in terms of its eloquence.

- The Qur'an's inimitability in terms of its context and approaches.
- The Qur'an's inimitability in terms of narrating about the unknown future.
- The Qur'an's inimitability in terms of narrating about the previous centuries and the extinct nations.
- The Qur'an's inimitability in terms of psychology.
- The Qur'an's inimitability in terms of its teachings and legislation, and
- Scientific miracles.

III.METHODOLOGY OF THIS STUDY

In the following sections provide analysis for in seven parts related to Sura An-Nisa' have been introduced; the first part about General Information on Sura An-Nisa', the second part is about Numerical studies on Sura An-Nisa', the third part forces on the Length of words and verses of Sura An-Nisa', the fourth part is about the size of Sura An-Nisa' comparing to the holy Quran, the fifth part is about the repetition of letters in Sura An-Nisa', the sixth part is about the number of letters and words in each verse of Sura An-Nisa' finally the seventh part is about the marking sign in Sura An-Nisa'. The following list shows the seven part of the analysis.

- Part 1. General Information on Sura An-Nisa'
- Part 2. Numerical studies on Sura An-Nisa',
- Part 3. Length of words and verses of Sura An-Nisa',
- Part 4. Size of Sura An-Nisa' comparing to the holy Quran,
- Part 5. Repetition of letters in Sura An-Nisa',
- Part 6. Number of letters and words in each verse of Sura An-Nisa'
- Part 7. Marking sign in Sura An-Nisa'

Each of the above parts contains few details, figure 1 shows the seventh analysis parts of Sura An-Nisa' with the details of each.

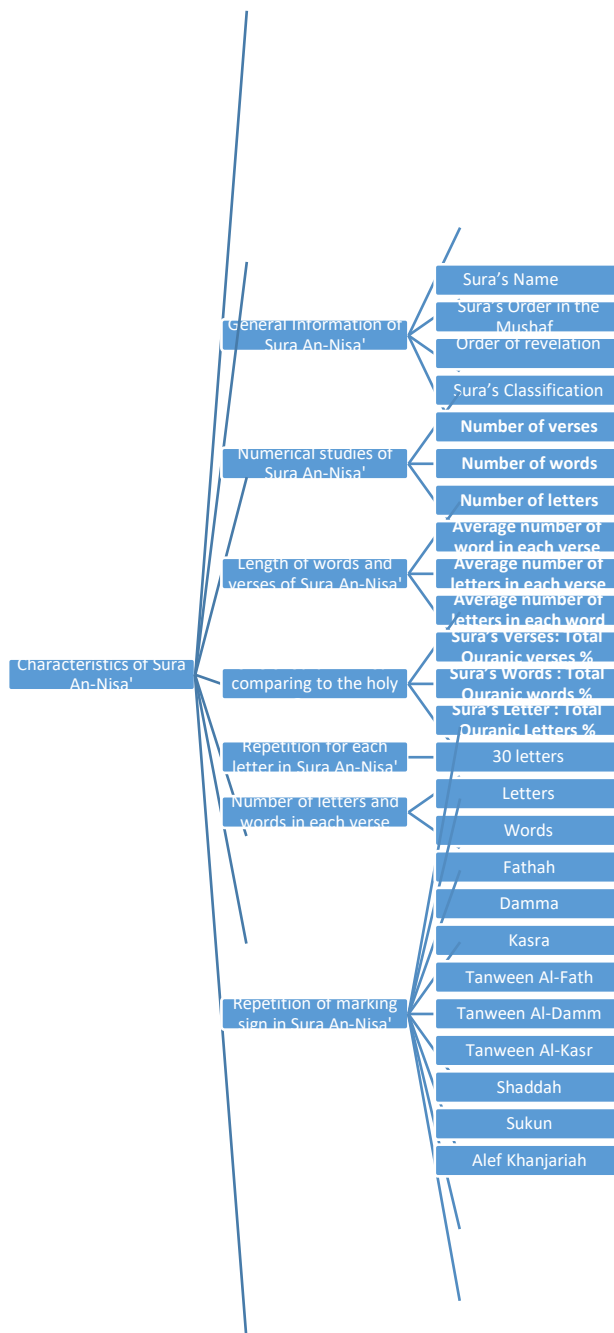

Figure 1. The most important characteristics of this Sura An-Nisa'.

Table 1 shows the general information on Sura An-Nisa' as an example that can be applied to any other Sura (chapter) later on, these information are Sura's Order in the Mushaf, Order of revelation and Sura's Classification (Meccan or Medinian).

TABLE I. The General Information of Sura An-Nisa'

Sura's Name	Sura's Order in the Mushaf	Order of revelation	Sura's Classification
An-Nisa'	4	92	Medinian

The above table showed that Sura an-Nisa' has order 4 in the Mushaf while it has order 92 in the revelation, and also shows that this Sura has reveled in Madina.

Table 2 shows some numerical studies on Sura An-Nisa' as an example that can be applied to any other Sura (chapter) later on, these information are Number of verses, Number of words and Number of letters.

TABLE II. The numerical studies of Sura An-Nisa'

Number of verses	Number of words	Number of letters
176	3747	16032

The above table showed that Sura an-Nisa' has 176 verses and 3747 words and 16032 letters and this is means that this Sura consider 4th longest Sura based on the number of verses and 2nd longest Sura based on the number of words as well as number of letters.

Table 3 shows some numerical studies on Sura An-Nisa' as an example that can be applied to any other Sura (chapter) later on, these information are Average number of word in each verse, Average number of letters in each verse and Average number of letters in each word.

TABLE III. The length of words and verses of Sura An-Nisa'

Average number of word in each verse	Average number of letters in each verse	Average number of letters in each word
21.289	91.091	4.278

Table 3 showed that the average number of word in each verse in Sura An-Nisa' is 21.289 word / verse and this is consider very high since the average number of words in each verse of the Quran is 12.424 only. The table also showed that the average number of letters in each verse of Sura An-Nisa' is 91.091 letters / verse and this is consider very high since the average number of letters in each verse of the Quran is 52.091. The table also showed that the average number of letters in each word of Sura An-Nisa' is 4.278 letters / word and this is consider very close to the average number of letters in each word of the Quran which is 4.192.

Table 4 shows the size of Sura An-Nisa' comparing to the holy Quran as an example that can be applied to any other Sura (chapter) later on, these information are Sura's verses comparing to the total Quranic verses, Sura's words comparing to the total Quranic words and Sura's Letter comparing to the total Quranic Letters.

TABLE IV. The size of Sura An-Nisa' comparing to the holy Quran

Sura's Verses: Total Quranic verses %	Sura's Words : Total Quranic words %	Sura's Letter : Total Quranic Letters %
2.822	4.836	4.934

The above table showed that the ratio of Verses of Sura an-Nisa' based on the total Quranic verses is 2.822 %. While the

ratio of words of Sura an-Nisa' based on the total Quranic words is 4.836 %. And the ratio of letters of Sura an-Nisa' based on the total Quranic letters is 4.934 %.

As we know that there are 30 including Hamza' (ء) and 2 different Taa' (ت & ة). **Error! Reference source not found.** shows the repetition of letters in Sura An-Nisa', and **Error! Reference source not found.** illustrates this table and Shows the ratio of repetition of letters in Sura An-Nisa' with the rest of the Quranic Suras (chapters).

TABLE V. Shows the number of repetition for each letter in Sura An-Nisa'

ا	ب	پ	ت	ث	ج	ح	خ	د	ذ	ر	ز	س	ش	ص	ض	ظ	ع	غ	ف	ق	ك	ل	م	ن	ه	و	ي
2	1	4	1	5	7	1	1	3	1	4	3	5	8	1	1	6	4	6	5	2	5	1	1	3	7	1	1
6	1	7	1	6	5	3	2	8	0	9	1	2	2	0	2	5	4	2	0	5	3	2	3	4	6	5	6

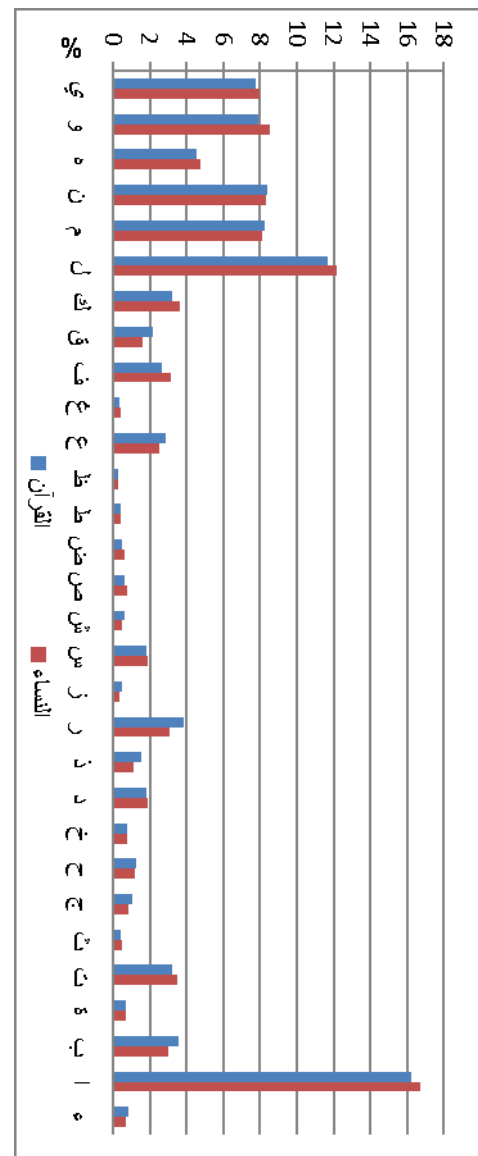

Figure. 2. The ratio of repetition of letters in Sura An-Nisa' and the rest of the Quranic Sura

Figure 2 showed the ratio of repetition of letters in Sura An-Nisa' are some time mora than and some time less than the rest of the Quranic Suras.

Figure 3 shows the number of letters in each verse in Sura An-Nisa', while Figure 4 presents the number of words in each of its verses.

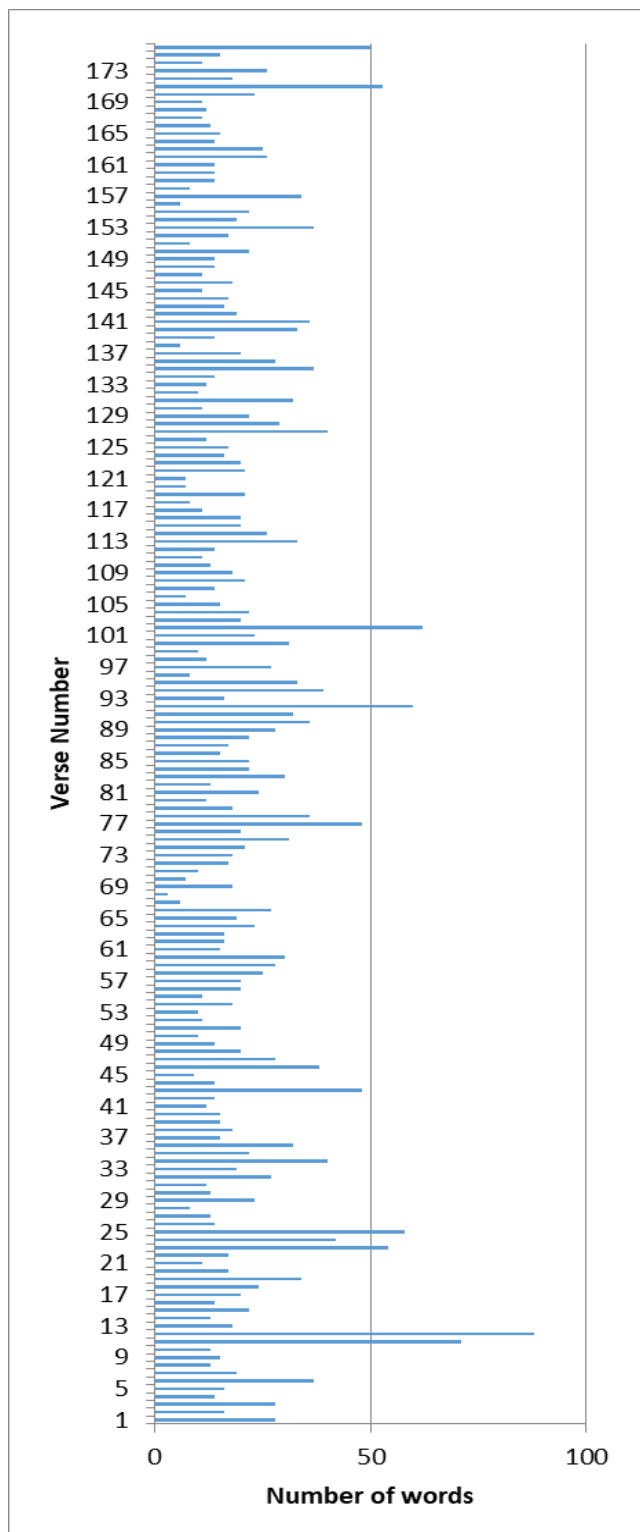

Figure 3. Number of letters in Sura An-Nisa'

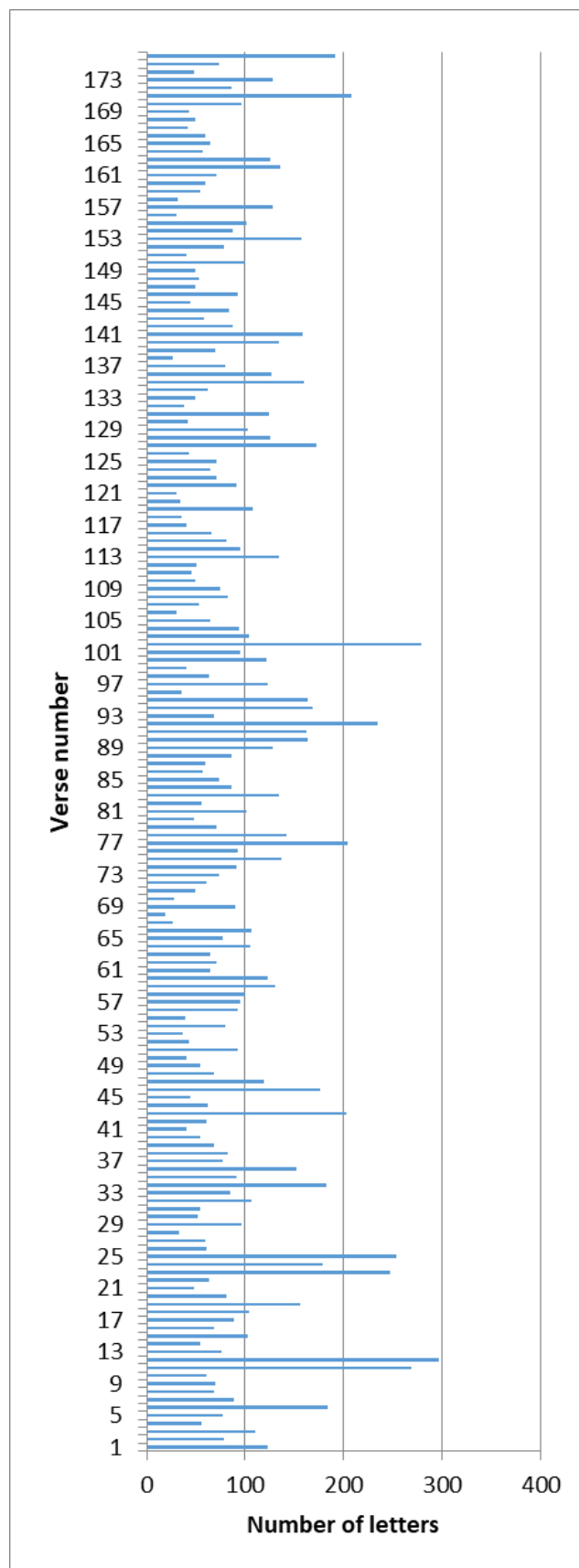

Figure 4. Number of words in Sura An-Nisa'

Figure 3 and Figure 4 showed that the number of letters in Sura An-Nisa' as well as the number of words in Sura An-Nisa' some time above the average while some time is below the average.

Error! Reference source not found. shows the repetition of the marking signs in Sura An-Nisa', and Figure 5 illustrates the repetition of the marking signs in Sura An-Nisa' as compared to the total Quranic Suras.

TABLE VI. Highlights the number of repetition of each marking sign in Sura An-Nisa'

Fathah	Damma	Kasra	Tanween Al-Fath	Tanween Al-Damm	Tanween Al-Kasr	Shaddah	Sukun	Alef Khanjaria
5798	1841	2268	380	75	85	1096	1716	379

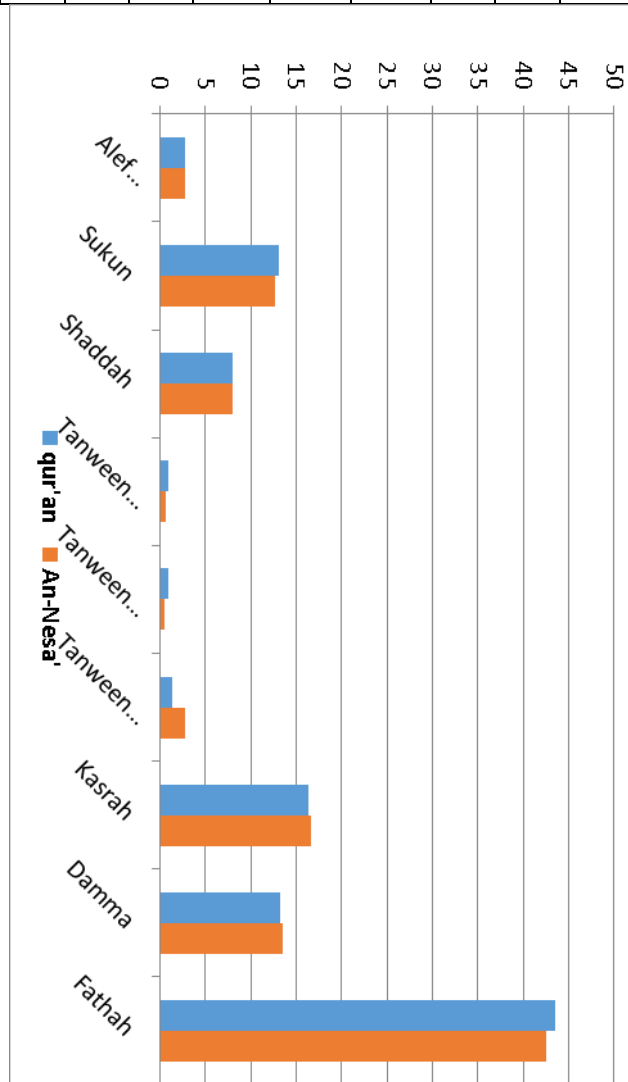

Figure 5. Figure 5. Shows the ratio of repetition of marking signs in Sura An-Nisa' and the Quranic Suras

Table 6 and Figure 5 showed the ratio of repetition of marking signs in Sura An-Nisa' are sometime more than and sometime less than the rest of the Quranic Suras.

IV. CONCLUSION

The statistical rules used in this study have been introduced at the beginning of the paper, we rely on what the Kuffians have adopted and the writers of the Medinan Qur'an, which is widespread in the narration of Hafsa from Asim. This paper focused on one Sura only (Sura An-Nisa') to show some statistical analysis on this Sura which can apply later on any other sura of the holy Quran. The paper included a scientific and systematic guide of this Sura; such as the order in the Qur'an, order based on revelation. It also included a guide of the words of the Qur'an according to the length, roots and repetition. Moreover, the paper included a guide of the Quranic letters marking signs.

ACKNOWLEDGEMENT

This paper was supported by International Islamic University of Malaysia under (FRGS19-083-0691) research project.

REFERENCES

- [1] A. M. Zeki and M. Zeki, Statistical Studies of the Holy Quranic Letters, Malaysia: IIUM Press, 2017. ISBN: 9789674187934
- [2] A. M. Zeki, "Statistical studies for the holy quran," in Regional Forum on the Teaching of The Holy Quran And Its Sciences. Organized by the International Institute for Muslim Unity of IIUM will collaborate with Islamic Educational, Scientific and Cultural Organization (ISESCO) in cooperation with the Holy Quran Memorization International Organization (HQMIO), IIUM. 12-15, Dec 2011.
- [3] M. A. Siddiqui, S. M. Faraz, and S. A. Sattar, "Discovering the Thematic Structure of the Quran using Probabilistic Topic Model," in Taibah University International Conference on Advances in Information Technology for the Holy Quran and Its Sciences, Madinah, 2013, pp. 234-239. DOI: 10.1109/NOORIC.2013.55
- [4] M. Rezal, J. Jannis, and T. L. R. Mengko, "The development of heart rate variability analysis software for detection of individual autonomic response on music and Quran recitation," in International Conference on Electrical Engineering and Informatics, Selangor, 2009, pp. 212-215. DOI: 10.1109/ICEEL.2009.5254787
- [5] M. S. Arabiah, A. Al-Salman, and E. Atwell, "KSUCCA the corner stone for studying the meanings of the holy quran words in the light of distributional semantic models," in Taibah University International Conference on Advances in Information Technology for the Holy Quran and Its Sciences, Madinah, 2013, pp. 652-659. DOI: 10.1109/NOORIC.2013.103
- [6] M. Zeki and A. M. Zeki. Statistical Studies of Quranic Letters, Malaysia: IIUM Press, 2011. ISBN: 978-967-418-183-3
- [7] M. Zeki and A. M. Zeki. Statistical Studies of Quranic Words. 3rd International Conference on Arabic Language. IIUM Kuala Lumpur, Malaysia: IIUM press, 2011, pp. 28-30 September. KL. ISBN: 978-967-0225-30-2.
- [8] M. Z. Khedher and A. M. Zeki, "The holy quran: statistical study of different chapters," in International Seminar of al-Quran in Contemporary Society (SQ2012), Kuala Terengganu, Malaysia, 1-2 Dec 2012.
- [9] R. Ismail, N. A. Rahman, and Z. A. Bakar, "Identifying concept from english translated quran," in IEEE Conference on Open Systems (ICOS), Langkawi, 2016, pp. 48-52. DOI: 10.1109/ICOS.2016.7881987
- [10] Y. M. Alginahi, M. Menacer, and A. Arbaoui, "Methodology and processes for collecting, indexing, structuring material and resources of quran and islamic studies," in World Symposium on Computer Applications & Research (WSCAR), Sousse, 2014, pp. 1-5. DOI: 10.1109/WSCAR.2014.6916814

Analysis of Factors Influencing Customers' Satisfaction in Super Indo Supermarket Yogyakarta

Dimas Bagus Wiranatakusuma
Universitas Muhammadiyah Yogyakarta,
Yogyakarta, Indonesia,
dimas_kusuma@umy.ac.id

Hana Putri Ayu Syaraswati
Universitas Muhammadiyah
Yogyakarta, Indonesia
[Hanaputri2308@yahoo.com](mailto:HanaPutri2308@yahoo.com)

Abstract— *this study aims to identify the influence of product quality, store image, shopping environment, service quality, and price on customer satisfaction. Populations in this research are customers in Super Indo Supermarket Seturan Yogyakarta. The sample used in this research consists of 80 people chosen using non-probability sampling, which is incidental sampling. This research uses multiple linear regression analysis. The validity and reliability testing of each indicator is taken before performing the multiple linear regression analysis. The results show that product quality has no effect on customer satisfaction, store image has a positive and significant effect on customer satisfaction, shopping environment has no effect on customer satisfaction, service quality has a positive and significant effect on customer satisfaction, and price has a positive and significant effect on customer satisfaction.*

Keywords: *product quality, store image, shopping environment, service quality, price, customer satisfaction.*

INTRODUCTION

The Indonesian economy has improved over time, especially in the Special Region of Yogyakarta. With this increasing economy, income and purchasing power of the people also increase. Therefore the consumption will increase and people will be more selective in using their money to meet their needs.

On the other hand, the increase in the economy is also followed by the development of modern markets. The modern market can be seen from the activities of buying and selling goods that are no longer carried out by bargaining activities. Consumers who want to buy an item only need to look at the price tag provided by the merchant. Besides, the arrangement and placement of products in a modern market environment is relatively neater.

These days, consumers tend to make the modern market a favorite place to buy goods. Consumers are the main target market in every business because without a consumer, a business will not be able to grow and achieve profit maximally. Getting consumers as customers in a mini market business is not an easy matter, this happens because there is a lot of competition from existing mini markets, thus requiring entrepreneurs to pay more attention to product quality (PQ), service quality (SQ), and price (P) offered to achieve a customer satisfaction (CS) (Kusumasari, 2011).

Measurement of customer satisfaction is very necessary to maintain customers by knowing the level of customer satisfaction. The benefits of customer satisfaction according to Tjiptono (2005) include: (1) the relationship

between the company and its customers is harmonious, (2) providing a good basis for repurchase, (3) encouraging customer loyalty, (4) forming an informal recommendation from mouth to mouth that will be very profitable for the company, (5) the company's reputation is well-built, (6) the profits earned goes up.

One of the modern markets in Yogyakarta is Super Indo. Super Indo provides a variety of daily necessities products with reliable quality, completeness, low prices, and convenient store locations. In this study, researcher examined customer satisfaction (CS) when shopping at Super Indo Seturan. The reason researcher chooses Super Indo Seturan is because of its strategic geographical location.

This study aims to analyze the factors influencing customer satisfaction. Previous researches on this topic have been conducted. However, the mixed results from those previous researches require further examination. The factors analyzed in this study are product quality (PQ), store image (SI), shopping environment (SE), service quality (SQ), and prices (P). The difference between this study and previous studies lies in the location used to collect samples and is carried out in the current year, 2019, so that the data obtained is more up-to-date and closer to the actual conditions.

THEORETICAL FRAMEWORK

2.1 Product Quality on Customer Satisfaction

Based on the need theory proposed by Abraham Maslow, physiological needs are basic human needs such as eating, drinking, and resting. In order for one to be able to meet the needs at the top level, these basic needs must be satisfied first. In fulfilling the needs of food and drink, certainly people pay attention to the quality of food or drinks consumed, so that the expected satisfaction is achieved and the higher other needs can be met.

Santoso (2010) states that customer satisfaction is closely related to the quality of goods offered. This is also reinforced by the opinion of Japariato and Djati (2011) which states that customer satisfaction is often determined by the quality of the product or service offered, so that good quality goods will make customers satisfied in shopping.

H₁: Product quality affects customer satisfaction

2.2 Store image on Customer Satisfaction

Prior to buying products and services to meet their needs, consumers usually consider the image of the stores

where they are going to shop. According to Saputra (2018), brand image is a perception and impression towards a company. Companies engaged in services in particular require a good image. A positive image of the company can also encourage customer satisfaction. Positive images that can drive customer satisfaction are the company's social responsibility, the ability to innovate, and good quality management that is able to build public trust. Those will be the indicators of company's image variable in this study image of the company can create customer satisfaction.

H₂: Store image affects customer satisfaction.

2.3 Shopping Environment on Customer Satisfaction

Peter and Olson (2002) divide the environment into two aspects and dimensions namely aspects of the social environment and aspects of the physical environment. Aspects of the social environment include all social interactions between and around other people directly or indirectly. Aspects of the physical environment include all non-human beings which can be divided into elements that have space or no space. Elements that have space include physical objects of all types (including products and brands) such as countries, cities, shops, and interior design. Elements without space include non-tangible factors such as temperature, humidity, lighting, noise level, and time.

Zulaikha (2015) has conducted research on the effects of service quality, store image, product quality, shopping environment, and customer expectations on customer satisfaction. The results of this study indicate that the shopping environment has a positive and significant effect on customer satisfaction when shopping. This indicates that customers prefer a clean, neat, and fragrant shopping environment than a dirty and smelly one.

H₃: Shopping environment affects customer satisfaction

2.4 Service Quality on Customer Satisfaction

When an employee is able to provide services as expected by customers, it will satisfy the customer (Fang, 2012). Customers are happy with friendly employees. In line with research conducted by Zulaikha (2015), service quality has a positive and significant effect on customer satisfaction.

H₄: Service quality affects customer satisfaction

2.5 Price on Customer Satisfaction

Price is one of the most sensitive factors among other factors because the price will have a direct impact on the sales and the profits. Determining the right selling price allows the seller to have a decent profit, as well as providing customer satisfaction before, during, and after the sale. A lot of customers consider price as the most important criteria in choosing a product (Anggraini, 2011). Thus the difference in price can affect customer shopping satisfaction. If the price of the product offered is quite cheap and the quality is in accordance with the desires of their heart, customer will definitely feel happy and satisfied in shopping.

This is in line with research conducted by Nguyen Ngoc Duy Phuong in 2017 which examined the Factors Affecting Customer Satisfaction and Customer Loyalty the Case of Binh Duong Ceramic Product. The results of this study indicate that price has a positive effect on customer

satisfaction.

H₅: Product price affects customer satisfaction

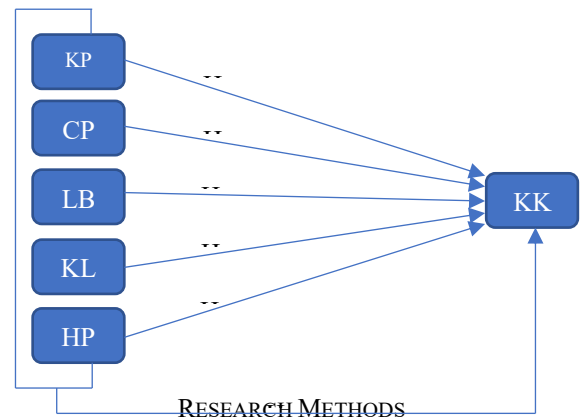

This research was conducted at the Modern Super Indo Seturan Market. Determination of this location is done deliberately with the consideration that the place is strategic, easy to reach, and close to the center of the crowd. The population in this study is visitors shopping at Super Indo Seturan.

The sampling method used in this study is non probability sampling with incidental sampling. Incidental sampling is a sampling technique based on coincidence. The sample used in this study is people who are shopping at Super Indo Seturan. The number of respondents used is 80 respondents. At the beginning of the study, 100 questionnaires were distributed, but 2 questionnaires were not returned and 18 other questionnaires were returned but were not suitable for use due to incomplete filling. The research conducted was aimed at respondents who were willing to be interviewed based on a questionnaire.

Likert scale is used to measure attitudes, opinions and perceptions of a person or group about an event or social phenomenon based on operational definitions set by researchers. With this Likert scale, respondents were asked to complete a questionnaire that required them to indicate their level of agreement with a series of questions. Questions or statements used in this study are usually referred to as research variables and are specifically defined by the researcher. The level of approval referred to in this Likert scale consists of 5 scale options ranging from Strongly Agree (SS) to Strongly Disagree (SD).

Data analysis in this study uses multiple linear regression analysis. The multiple linear regression formulations in this study are as follows:

$$Y_t = a + b_1KP_t + b_2CP_t + b_3LB_t + b_4KL_t + b_5HP_t + e_t$$

Remarks:
 Y_t = Customer Satisfaction
 KP_t = Product Quality
 CP_t = Brand Image
 LB_t = Shopping Environment
 KL_t = Service Quality
 HP_t = Product Price
 a = Constant Value
 e_t = Confounding Factor
 b_1, \dots, b_5 = Regression Coefficient

4.4 t Test

Table 4.4
t Test

Variables	t-Statistic	Probability
C	1,135	0,260
PQ	0,179	0,858
BI	2,126	0,037
SE	-1,017	0,312
SQ	1,585	0,012
PR	3,904	0,000

Source: Primary Data Processed, 2019

From the results above, it is proven that the quality of the product has a significance value above p value of 0.05 which proves that this hypothesis is rejected. This is because the quality of the product is not really a major consideration to increase customer satisfaction. In accordance with Maslow's theory of needs, the things that are considered by customers to feel satisfaction are how the fulfillment of basic needs such as physiological and safety can be fulfilled. If the quality of the product is high enough but is unable to meet the basic needs of the customers because the price is not affordable, then the quality of the product cannot be the reason for satisfying customers.

From the results of the t test, it is proven that the store image has a significance value below the p value of 0.05 which proves that this hypothesis is accepted. This is because customers choose shopping places with a good reputation where they can be relied upon to meet their needs.

t test results indicate that the shopping environment has a significance value above the p value of 0.05 which proves that this hypothesis is rejected. This is because customers do not use the shopping environment as a measure of their satisfaction. According to Maslow's theory of needs, the most basic needs that must be met are physiological and then security needs. If in making a purchase transaction the customer is able to meet both of these needs, they will already feel satisfied.

t test results also indicate that service quality has a significance value below the p value of 0.05 which proves that this hypothesis is accepted. This is because customers will see how the quality of the services available at the shopping mall. According to Maslow's theory of needs, service quality will provide benefits directly to consumers to get convenience when making a purchase transaction. With the ease that is felt when they make a purchase transaction, they will psychologically feel received attention and comfort, where not only physiological and security needs are achieved but also the comfort and sense of respect that is at the third level of need. Friendly and helpful service from the employees will make customers feel confident in the shopping place which will increase customer satisfaction.

From the results of the t test, it is proven that the price has a significance value below the p value of 0.05 which proves that this hypothesis is accepted. This is because the price is one of the most sensitive factors among other factors because price will have a direct impact on the sale of goods

RESULTS AND DISCUSSIONS

4.1 Validity Test

The validity of the questionnaire instruments in this study was tested using Confirmatory Factor Analysis (CFA). The validity of the question item in a study is measured by the value that is on the KMO (Kaiser-Meyer-Olkin) > 0.50. The test results are shown in table 4.1 as follows:

Table 4.1
Kaiser-Meyer-Olkin

Kaiser-Meyer-Olkin	0,739
Significance	0,000

Source: Primary Data Processed, 2019

4.2 Reliability Test

In this study, the variable is said to be reliable if it gives a value of $\alpha > 0.70$. The following explanation of the reliability test processing in this study is shown in table 4.3.

Table 4.3
Reliability Test

Cronbach's Alpha	N of Items
0,857	18

Source: Primary Data Processed, 2019

4.3 F Test

Table 4.4
F Test

Model	Sum of Squares	Df	Mean Square	F	Sig
Regression	78,188	5	15,638	9,619	0,000
Residual	120,299	74	1,626		
Total	198,488	79			

Source: Primary Data Processed, 2019

The results in table 4.4 show a significance level of 0.000 which proves that the p value is smaller than 0.05. This means that all independent variables in this study are able to explain Customer Satisfaction (KK) as the dependent variable. The model in this study is also good and feasible to use.

and the benefits obtained. According to Maslow's theory of needs, the basic needs of consumers as an individual are physiological needs. Consumers certainly expect their basic needs to be met at low prices. Consumers will also make price comparisons at various shopping venues, where they will choose the place that provides the lowest price. Low prices will make consumers interested in repurchasing transactions in the same place. So prices can increase consumer satisfaction.

CONCLUSIONS

Based on the explanation above, two hypotheses are rejected and three hypotheses are accepted. The rejected hypotheses are hypothesis 1 and hypothesis 3. This shows that product quality and shopping environment are not the main factors forming customer satisfaction. There are other more impactful factors to customer satisfaction such as store image, service quality, and price. Thus, hypothesis 1, 2, and 3 are accepted.

For further research, it is better to use a wider sample and population. In addition, future research should consider using control, mediation, intervening or moderation variables to develop existing results. Future studies should use other variables that are less frequently studied, such as psychological effects, switching costs, and consumer empathy.

This study also has some limitations. This study only uses samples and populations of Super Indo Seturan customers. This study also only uses one-way testing and is only limited to five variables.

REFERENCE

- Anggoro, Linggar M. (2000). *Teori dan Profesi Kehumasan*. Jakarta: Bumi Aksara
- Anggraini, Kristina Dewi. (2011). Pengaruh *Retailing Mix* Terhadap Loyalitas Toko Pada Ritel Hypermart Solo Square di Kota Solo. (*Electronic Resource*) Kertas Kerja Program S1, Fakultas Ekonomika dan Bisnis Universitas Satya Wacana
- Deyalage, Piruni A dan Kulathunga, Dushyanta. (2019). *Factors Affecting Online Customer Satisfaction: The Sri Lankan Perspective*. Canadian Center of Science and Education.
- Dunne, Patrick M. dan Lusch, Robert F. (2005). *Retailing*, 5th Edition. South Western : Thomson.
- Fang, Kwoting *et.al.* (2012). *Perceived Ease of Use, Trust, and Satisfaction as Determinants of Loyalty In E-Auction Marketplace*. Taiwan: Transworld University.
- Gerson, Richard F. (2001). *Mengukur Kepuasan Pelanggan*. Jakarta : PPM.
- Ghozali, I. (2001). *Aplikasi Analisis Multivariate dengan program SPSS*. Semarang: Universitas Diponegoro.
- Ghozali, I. (2013). "Partial Least Square, Konsep, Teknik dan Aplikasi Menggunakan Program SmartPLS 3.0". Semarang: UNDIP.
- Ghozali, I. (2016). *Aplikasi Analisis Multivariate dengan program SPSS*. Semarang: Universitas Diponegoro.
- Hartley, Robert F. 1980. *Retailing: Challenge and Opportunity*, 2nd Edition. Boston: Houghton Mifflin.
- Indriantoro, & Supomo, n. (1999). *Metodologi Penelitian Bisnis Untuk Akuntansi & Manajemen*. Yogyakarta: BPFE.
- Irawan, H. (2008). 10 Karakter Konsumen Indonesia. *Majalah Marketing Edisi Khusus/II/2008*.
- Irawan, Handi. (2003). *Mengukur Citra Perusahaan*. <http://www.frontier.co.id> (diunduh 1 Mei 2019)
- Japarianto, Edwin dan Djati, S. Pantja. (2011). *Pengaruh Service Retail Marketing mix Terhadap Kepuasan Belanja Tourism Shopper Di Plaza-Plaza Surabaya*, Jurnal Mitra Ekonomi dan Manajemen Bisnis, Vol.2 No.1 April 2011:96-114. <http://scholar.google.co.id>. (diunduh 1 Mei 2019)
- Jasfar, Farida. (2009). *Manajemen Jasa*. Bogor: Ghalia Indonesia
- Kotler, Philip. dan Armstrong. (1999). *Prinsip-Prinsip Pemasaran Jilid 1*. Jakarta: Erlangga. 2000. *Manajemen Pemasaran*. Jakarta : Indeks
- Kotler, Philip., & Keller, K. L. (2006). *Marketing Management*. Pearson Education. 2012. *Marketing Management*. Global Edition. Pearson, p. 153
- Kotler dan Armstrong. (2008). *Prinsip-Prinsip Pemasaran*, Edisi 12 jilid 1. Jakarta: Erlangga.
- Kotler, Philip; Armstrong, Gary. (2012). *Principles of Marketing*. Fourteenth Edition. Pearson, p. 248.
- Kurniawan, Deby Herry. (2009). *Pengaruh Retailing Mix Terhadap Loyalitas Toko Pada Toko Elektronik Wijaya Baru*, (Electronic Resource). Skripsi Program S1 Fakultas Ekonomika dan Bisnis Universitas Kristen Satya Wacana (tidak dipublikasikan).
- Kusumasari, Luh Gede Dewi. (2011). *Pengaruh Faktor Kepuasan Terhadap Kepuasan Konsumen Pada Pendawa Mini Market Di Desa Bajera*. Undiksha Press. Vol 1, No 1.
- Lupiyoadi, Rambat. (2001). *Manajemen Pemasaran Jasa, Teori dan Praktek*. Jakarta: Salemba Empat.
- Maslow, Abraham H. (1970). *Motivation and Personality*. New York: Harper & Row Publisher.
- Maslow, Abraham H. (1994). *Motivasi dan Kepribadian (Teori Motivasi dengan Pendekatan hierarki Kebutuhan Manusia)*. Jakarta: PT PBP.
- Moh Abdul Mukhyi dan Iman Hadi Saputro. (1995). *Pengantar Manajemen Umum*. Jakarta. Gunadarma.
- Muzammil H, *et.al* . (2010). *Factors Affecting Customer Satisfaction*. International Research Journal of Finance and Economics
- Peter, Paul and Olson, Jerry. (2002). *Consumer Behavior and Marketing Strategy*. 6th ed. New York: McGraw-Hill, Inc.
- Tjiptono, Fandy. 2000. *Manajemen Jasa*, Edisi 2 cetakan 3. Yogyakarta: Andi Offset.
- Tjiptono, Fandy. 2005. *Pemasaran Jasa*. Yogyakarta: Andi Offset.
- Santoso, Novi Setyawardhani. 2010. *Pengaruh Retailing Mix Terhadap Loyalitas Toko Pada Toko Elektronik Wijaya Baru*. Skripsi Program S1

- Fakultas Ekonomi Dan Bisnis Universitas Kristen Satya Wacana.
- Saputra, Mada. 2018. Pengaruh Kualitas Pelayanan dan Citra Perusahaan Terhadap Kepuasan Member D'Oksigen Clasik Fitnes di Kota Padang. Vol 1, No 4
- Robbins, Stephen P dan Judge, Timothy A. (2008). Perilaku Organisasi. Jakarta: Salemba Empat.
- Sugiyono. (2011). Motode Penelitian Kuantitatif dan Kualitatif dan R&D. Bandung: Alfabeta
- Zulaikha, Ika Mariana. 2015. Pengaruh Kualitas Layanan, Store Image, Kualitas Produk, Lingkungan Belanja, dan Harapan Konsumen Terhadap Kepuasan Konsumen [Skripsi]. Yogyakarta (ID): UIN Sunan Kalijaga.

Religious Literacy of LDK UNJ Activist

R. Siti Nurlela

Universitas Negeri Jakarta, Indonesia,
sitinurlela_pai16s1@mahasiswa.unj.ac.id

Sari Narulita*

*Corresponding author
Universitas Negeri Jakarta, Indonesia,
Sari-narulita@unj.ac.id

Devi Kurniati

Universitas Negeri Jakarta, Indonesia,
devikurniati_pai17s1@mahasiswa.unj.ac.id

Aminah

Universitas Negeri Jakarta, Indonesia,
aminah_pai17s1@mahasiswa.unj.ac.id

Abstract - The spread of the notion of radicalism on the state campus has raised concerns among many parties. Moreover, UNJ, aside from being a state campus, is also claimed to be the campus of teacher printing. This study aims to map the religious literacy of LDK UNJ activists who are considered to represent UNJ students as a whole; especially LDK activists have a sustainable regeneration system. LDK is a missionary institution that has a role in increasing Islamic understanding among UNJ Muslim students. The method in this study is qualitative descriptive with data collection through documentation, observation, and interviews. The findings show that LDK UNJ Activist's religious literacy is seen from the level of understanding and the religious attitudes of the UNJ. Theological understanding appears in the study followed, and books that must be read. The implementation seems to be seen in the application of 10 Muslim cultures. Islamic knowledge that is formed is still in popular understanding, a basic understanding that leads to movement; not yet on the belief that makes them able to determine attitudes based on consciousness.

Keywords: LDK, Religious Literacy, Mentoring

INTRODUCTION

Religious radicalism has become an interesting phenomenon in recent years. This phenomenon was evidenced by a survey conducted by the BNPT (National Counter-Terrorism Agency) in 2016, which stated that 26.7% of youth agreed to do jihad using violence (Kumpran, 2018). Religious radicalism in a sociological view is one form of reaction by religious people to deal with issues of modernization and globalization (Hadiyanto, 2017). The condition of modern society has a view of rationalism as the basis of an objective moral order; on the other hand, they are also people with certain religions who prioritize the understanding of their religious teachings in life. This difference of views is evident in the selection of leaders among them. The attachment of various cultural and religious tribes makes competence a condition that must be owned by the leader; but on the other hand, the similarity of religion seems to be a mandatory requirement in choosing leaders. The intense friction between these two views is what makes the radicalism in the community vulnerable. Concerns about the spread of religious radicalism due to its ability to damage the social order of society and result in the

fall of civilian casualties; This model of radicalism has the potential to increase understanding of terrorism.

In one of his statements, BNPT stated that radicalization began to bloom and spread in the campus environment. This radicalism is associated with religious conditions at the University. The lack of understanding of theological understanding is claimed to be the cause of the increasing spread of knowledge of radicalization in the campus environment. (Siregar, 2018).

It is reporting from the institute's equivalent research results that 10 (ten) state universities in Indonesia are exposed to radicalism. The intended universities are the University of Indonesia, Syarif Hidayatullah State Islamic University, Bandung Institute of Technology, Sunan Gunung Djati Bandung State Islamic University, Bogor Agricultural Institute, Gadjah Mada University, Yogyakarta State University, Brawijaya University, Airlangga University, Mataram University. Halili, director of research at the institute's equivalent stated that one indication of the University was exposed to the notion of radicalism because of the many discourses and religious movements that were exclusive; and this happens because of a lack of theological understanding of students at Public Higher Education. Lack of knowledge of religion will make students vulnerable in a variety of new thoughts that have not been validated validity.

Jakarta State University is one of the public universities with a diversity of students who do not explicitly study religion. Even this diversity has the potential to direct students in new thinking, if not correctly criticized. Also, the Jakarta State University (UNJ) is one of the Universities of the LPTK (Education Institution and Education Personnel), a University of Teacher Printers. UNJ graduates are expected to be able to become teachers in communities with various backgrounds. Therefore, the understanding received by students / prospective teachers during the learning process in Higher Education will impact on the material that will be delivered to students/community later.

Religious understanding at UNJ or later known as religious literacy at UNJ was carried out in various ways. One of them is informal lectures. Religious Education becomes a compulsory subject that must be taken by students who take Education at Jakarta State University. The content of PAI courses has a charge of 3 (three) SKS (semester credit system). Religious learning in Higher Education has a strategic position in the effort to transmit

knowledge and attitudes among students. Religious learning in Higher Education is learning with a process of critical, analytical, deductive, inductive, reflective thinking and triggering high order thinking through participatory creative dialogue to foster the spirit and motivation of lifelong learning. The PAI curriculum in Higher Education refers to the curriculum set by the government, which in this case is DIKTI (Higher Education) and the Ministry of Religion (Ministry of Religion).

The limited duration of religious learning makes students try to explore and understand religion outside their formal lectures. Students seek spiritual knowledge outside the lecture activities non-formally such as attending a theological study held by a religious institution called the Campus Da'wah Institution. The interest to take part in the study is based on the belief that religion is not only an understanding but also the formation of attitudes that are applied by deeds. Religion in the life of individual functions as a value system that contains certain norms which become the terms of reference in behaving and behaving so that they are in line with their religious beliefs. (Allan, 2014: 318). The relevance of attitude and understanding, make the curriculum and reference to religious learning become one thing that needs attention. This relevance makes religious literacy used very important to know so that the attitude of understanding religion can be appropriate. Religious literacy is not only about holy reading books but also about the implementation of religious texts that are read about social reality (Moore, 2006: 14).

LDK, is a forum for movement in spreading Islamic understanding, has a significant role in the campus environment. LDK itself is one of the UKM (Student Activity Unit) at Jakarta State University and has a unit in each faculty known as LDF (Faculty Da'wah Institution).

In the process of developing religious understanding, LDK has a regeneration system that is good at regenerating the next management. The regeneration activities carried out include selecting students who are actively participating in religious activities held by LDK and recruiting them to become permanent LDK members. All new students are directed to follow LDF, and it is a natural selection that makes some survive becoming members of LDF and has the potential to become a mentor for their junior later. A bright and orderly regeneration system makes LDK have a clear organizational structure even this continues to the level of alumni.

Based on a clear structure and a stable cadre system, understanding the religious literacy of LDK activists is essential to understand. In addition to being able to anticipate the notion of radicalism, which is rampant, it is also a medium to evaluate LDK to be better in the future.

LITERATURE REVIEW

Literacy, according to KBBI, is defined as the ability of individuals to process information and knowledge to achieve the expected skills. In today's context, literacy has a comprehensive meaning; literacy can mean technological literacy, politics, critical thinking, and sensitivity to the surrounding environment. Thus, someone can be said to be literate if he has done something based on

the understanding gained from reading (Wahyudin, 2012). Whereas religion, according to KBBI, is everything related to religion.

Thus literary, religious literacy is understood to be literate or to understand religion properly. However, in terms of religious literacy is not limited to understanding religion in terms of its teaching principles; but also includes how religion is applied in daily life. Besides, religious literacy also consists of an understanding of the traditions of beliefs, and religious rituals embedded in the faith. (Irfan, 2019) Moore mentions that religious literacy is acquired through several means. First, through religious teaching; and the second through "learning about religion" (learning about religion) (Moore, 2006:14).

Moore defines religious literacy as an ability to understand the teachings of religion not only on its normative doctrine but also on how religion is applied in real life it lives. In the findings of religious literacy in several countries (Indonesia, India, Pakistan, and the United States), there will be a low level of religious literacy. The quality of understanding one's religious literacy influences the religious behavior of the adherents. He saw that the development of Islamic phobia in parts of American society was partly due to the low level of religious literacy about Islam and the spiritual practice itself. Moore said the symptoms were religious illiteracy or "religious injustice." On the contrary, the strengthening of extremism, radicalism, and intolerance in some Muslim societies relates to their low religious literacy towards Islam itself (Moore, 2006). Here it can be concluded that a good understanding of religion will influence the attitude it demonstrates, which will be following the Islamic values it has learned.

Religious literacy is the ability to see and analyze the fundamental links between religion and social, political, and cultural life through various perspectives. Religious literacy presupposes several things: first, a basic understanding of central texts that are at the core of religious teachings, history, and contemporary manifestations of religious traditions that are formed according to specific social, political and cultural contexts. Second, religious literacy presupposes the ability to see and explore various dimensions of the political, social, and cultural expression of religion in a particular space and time. (Dinham & Francis, 2015)

Thus it is understood that the religious literacy in this study is the ability of students to understand the fundamental meeting point between religions - which in this case is Islam - with social, cultural and political dimensions. Students are considered to have excellent religious literacy skills, it appears with two things, namely (1) Having an understanding on the basis of history, the central text, beliefs, and practical manifestations of the religion adopted; and (2) Having the ability to understand it in the social, cultural and political dimensions of religion.

Whereas what is meant by activists, according to *Kamus Besar Bahasa Indonesia* (KBBI/the Big Indonesian Language Dictionary) means people, especially members of the organization both in the political, social, labor, farmer, youth, student, women who work actively to encourage the implementation of something or various activities in their

organization. The activists in this research are religious activists who take part in activities inside or outside the university, especially at the Jakarta State University.

The campus *dakwah* institute is a forum for da'wah activists to rebuild the identity of Islam. Re-establishing the elements of unity, brotherhood and the strength of Islam to build *ummatah wahidah* (united people) to strengthen the thinking and *syariat* (the law) of Islam in all systems of life to restore the role of Islam as a teacher and lighthouse of human civilization until Islam became a blessing for the universe. (Asep, 2011)

The Dakwah Institute of the Jakarta State University Campus is known as the Campus Da'wah Institution of the Muslim Community of UNJ, which is then abbreviated as LDK Salim UNJ. LDK Salim UNJ is one of the student activity units at UNJ based on Islamic values. This institution is managed by UNJ Muslim students to develop Islamic activities at UNJ which was founded in 1409 H or 1989 M. This organization is a place to accommodate the aspirations of Muslim students and prioritize personal values among Muslims. LDK Salim UNJ oversees 8 Da'wah Institutions at the faculty level called the LDF (Da'wah Institution at the Faculty) and 1 (one) QI (Institution for learning Qur'an).

One indicator of the success of campus missionary institutions is how to improve the religious behavior of students who become religious activists in particular and all students in general. But the current conditions, many students who have not behaved by Islamic values. Like throwing litter, cheating on exams, communicating with lecturers disrespectfully. Ideally, a Muslim can apply Islamic values in him. Religion should be the norm system in a society that is very important and can be used at any time (Berger, 1992).

Thus the activists of the Campus Da'wah Institution referred to in this study were students who were administrators in the organization of the Campus Da'wah Institution, namely those who manage and carry out Islamic activities at Jakarta State University to broadcast Islam to all UNJ communities in general.

METHODOLOGY

The method used in this study is a descriptive-analytical method with a qualitative approach. This article describes a source of religious literacy that builds the attitude of the LDK UNJ activists; including references or literature that are read and reviewed by religious groups or activists on campus and religious studies they attend.

Research data was obtained through observation and interviews with LDK UNJ activists. The results obtained will be used to analyze and determine the level of religious literacy. Information on this level of literacy is expected to be an evaluation of the progress of the LDK UNJ

RESULT & ANALYSIS

Understanding the religious literacy of the LDK UNJ activist can only occur if it has recognized. The Institution of Da'wah of the Jakarta State University or abbreviated as LDK UNJ was established in 1989; and

better known as LDK Salim UNJ. LDK as one of the institutions that aim to provide Islamic understanding for UNJ students.

LDK is a unit of student activity based on Islam, an institution managed by Muslim students to coordinate and develop Islamic activities in Higher Education (Saefullah, 2017: 190). Under the auspices of the LDK, there are faculties of da'wah or abbreviated LDF which focus on religious activities in each faculty, which in practice are still controlled by the Campus Da'wah Institution. The existence of LDF in the Faculty can facilitate LDK in recruiting students; it also makes it easier for LDK to manage the variety of studies conducted by LDF.

LDK Salim UNJ has a vision that is "as a UNJ Muslim Face and a Collaborative and Friendly Da'wah Initiator in realizing a community affiliated with Islam." It is embodied in the LDK Salim UNJ mission with 1) becoming the center of religious guidance of UNJ Muslim students who cling to the Qur'an 'and As-Sunnah. 2) accelerating the potential and *ukhuwah* (brotherhood) of LDK Salim UNJ administrators; 3) optimizing the role of the preaching institutions throughout UNJ in broadcasting Islam; 4) Providing friendlier, more sociable services ; 5) Being a pioneer of productive and responsive Islamic media in broadcasting the issue of publicity issues, and 5) Building a financial system supporting independent and productive da'wah.

One of the unique characteristics of LDK is its ability to carry out continuous coaching through cadre. Some of the coaching strategies that have been formed in cadre efforts are as follows,

1. Transfer or mentoring, fostering the participants

Mentoring is a group of small circles with 4-10 participants with the concept of creating a circle. In addition to studying religious material, mentoring is also a place to share stories and problems experienced in everyday life; like how the atmosphere in the classroom, learning achievement, even problems at home. Mentoring is so that members can solve problems together. With that concern, togetherness is felt and can lead to new motivation and enthusiasm for its members.
2. Seminars, dialogues, and training

Seminars, dialogues, and training are an arena for LDK UNJ activists to add insight into their literacy, especially religious literacy. Seminars, dialogues, and training are usually held around UNJ or even in other institutions. The material raised is often not far from the issues that are currently being discussed. For example, content about LGBT in the view of Islam, leadership in the Islamic world, and so on.
3. Rihlah/traveling

Rihlah in the LDK program carried out outside the campus and aimed to engage in nature and strengthen *ukhuwah* (brotherhood). This activity is usually carried out in the Bogor area for 3 (three) days and 2 (two) nights. The activities carried out during the event included mentoring, studies,

carrying out sunnah prayers, games, and light discussions that discussed Islamic knowledge and insights.

4. Mabit (Night of Faith and Takwa)

Mabit is an activity that focuses more on spiritual improvement. The arrangement of the event is made, focusing more on the activities of worship, such as *iktikaf* (stay in the mosque for prayer), doing obligatory or sunnah prayer in the congregation, *tilawah* (reading Quran), and so forth. Mabit aims to increase faith and loyalty in the participants, especially after completing a series of events.

5. Ta'lim

Ta'lim is one of the activities that can be used as a reference in understanding religious material; if mentoring is only a discussion around spiritual knowledge and insights that are still basic, then the religion is more on the deepening of a theme or Islamic material.

The cadre process begins with mentoring activities that must be followed by all new students. The mentoring activities are arranged in conjunction with the campus introduction period, which is attended by all new students. Over time, students will appear consistent in participating in mentoring activities, when several other students for one reason or another cannot go back to participating in mentoring activities. Based on interviews with several students who did not return to participating in the mentoring activities, it was known about some of the reasons they left the mentoring event; among them is the limited knowledge possessed by the mentor. This reason was felt when they asked a lot of things they wanted to know, but the mentor was unable to provide a convincing and satisfying answer. Another factor that makes students not take part in mentoring is the incompatibility of the time of mentoring because they coincide with the time of the implementation with other activities that they must follow. Then there are also reasons that the material is given is repeated (especially for some students who have studied related content), the method used is not unusual, the shame is due to rarely taking part in mentoring activities, and prioritizing lecture assignments.

Another activity that shapes cadre is to get new students. This activity aims to strengthen the fraternity of new students and their seniors further. In practice, each LDF has a different way of doing it. Each has a different concept and activity name; still with one goal, namely to strengthen the brotherhood of fellow LDK activists.

Students who are loyal and consistent in participating in LDK activities will advance in the next stage; an advanced formation called the Muslim Leadership Training (MLT). The event was filled with material about da'wah aimed at not only activists being the object of da'wah, but became the subject of da'wah; become a party that conveys Islamic values to those in need. The sources of the MLT activities are LDK alumni who have experience.

After going through all the regeneration processes, to know more about the level of religious literacy of LDK activists explained in the findings as follows,

A. Understanding of religious literature

In the process of learning theological understanding, LDK activists refer to the curriculum determined by the UNJ LDK. Learning themes can be modified according to the needs of each faculty. Based on the data obtained through interviews with sources, it is known that the material in the study or mentoring has a syllabus or curriculum that has been established for generations; from generation to age. But the development of this learning material is adapted to the needs of the faculty and the issues that are being discussed. For the speakers who fill in this activity, LDK invites speakers who are considered capable of reviewing the predetermined themes. The learning of religious understanding is emphasized in routine weekly study activities.

The implementation of routine studies was conducted every week, Thursday night for extensive research and on Friday for a unique study of women. The study was conducted on the *Tauhid* (oneness of Allah), *fiqh* (Islamic law), *Sirah Nabawiyah* (the life history of the Prophet and his companions) and raised issues that were viral or and were widely discussed in society. As the study progresses, there is a hijab or barrier between women and men. It is meant that study participants can focus on activities and to avoid *Ikhtilat* (mixed men and women who are feared will create unique feelings toward the opposite sex). Hijab applies virtually in all LDK activities; not only during the study but also during mentoring, board meetings, and the like.

This weekly routine study is complemented by an activity called mentoring. The mentoring system or "*liqo*" is a meeting between students known as mentees and directors called mentors or *murobbi* (mentors), who are LDK activists. This meeting is held once a week consisting of 4 (four) to 10 (ten) students. Activities carried out in mentoring include activities that aim to improve the quality of worship such as reading the Qur'an, sharing experiences and knowledge of each member and advising each other among members. Also, sometimes reviewing the material discussed in the study.

The formation of mentoring groups was carried out during the first lecture activities, namely during the campus introduction period to new students, with another name, Forum Group Discussion (FGD). The forum then changed its name when students took part in the cadre activities carried out by LDK in the form of *rihlah* or joint traveling activities that strengthened the brotherhood of fellow mentoring group members.

In the mentoring process, a chosen mentor (usually a senior in LDK and students in the same Faculty) will continue to monitor the quality of his mentee worship so that he always applies Islamic values in living his life. Monitoring is carried out by providing *mutaba'ah yaumiyah* (daily activities that are by Islamic teachings) sheets or daily activities held by each member of the mentoring group, which will then be delivered when the mentoring is carried out.

Usually, members who do not carry out the deeds that are determined in the *mutaba'ah yaumiyah* (daily activities that are by Islamic teachings) such as reading the Qur'an, Dhuha sunnah prayer, almsgiving, and reading the morning and evening dhikr called *al-matsurat* will get advice from their mentor so that he can increase practice recommended the practice.

In addition to controlling *mutaba'ah yaumiyah* (daily activities that are by Islamic teachings), the mentor will also check the ability to read the Qur'an and receive memorandum deposits for those who memorize the Qur'an. Not infrequently when mentoring takes place, some mentoring members ask about the problems they are facing, especially those of a religious nature that are still unknown, this is the reason for the need to choose competent mentors in understanding Islamic religion and its practices. The role of alumni in forming a vast cadre of mentors with the slogan "before filling in (teaching the younger siblings) must be filled (by learning religious knowledge through mentoring.)" This slogan is always encouraging mentors always to learn the teachings of Islam.

The criteria for mentors that must be possessed are having a good understanding of religion by following studies conducted on campus and off campus. Before being designated as a mentor, prospective mentors must attend a series of mentoring schools held by LDK to prepare competent mentors. The mentors increased their Islamic understanding from LDK alumni. An alumni whose study period at his campus has expired still obliged to be able to develop his class. This fact makes the relationship between fellow LDK always maintained.

Based on the observations made, it appears that the mentor, besides giving guidance to his younger siblings, they also have their mentoring group consisting of several mentors. This group is guided by *murobbi* who generally are alumni who have a qualified scientific capacity. The group members also changed according to *murabbi* recommendations. Usually, changes are adjusted to increase the ability of the mentor.

Similar to LDK members, administrators of campus da'wah institutions also receive supervision through *Mutaba'ah Yaumiyah* targets or daily practice that they must do every day. Among the Prayer Times (SAW) at least three times in one day, the Al-Qur' recitations are at least 1/2 (half) juz, Dhuha sunnah prayers are at least two *raka'at*, morning dhikr is at least one time a day, and Fajr *infaq* (*set aside pocket money*) every day. These targets must be reported every day through the WhatsApp group. When they fail to meet the specified destination, they will get a punishment from *Murabbi*.

In addition to through study and mentoring, the religious understanding was formed from a variety of books and readings that became a guide for mentors. Based on the results of interviews with one of the LDJ UNJ activists, books that must be read by LDK

activists are generally books about movement; one of them is a book entitled "True Da'i Commitment." Also included are other books; when discussing history, the reference to the paper used is Manhaj Haraki (Sirah Nabawi in terms of its movements); in terms of organizing or preaching the text is Istiab (da'wah fiqh) or it can be referred to as the method of da'wah.

Based on the interviews, the list of books that are required to be read by UNJ LDK student activists is as follows,

Table 1. Religious Reference / Literacy in the LDK UNJ

NO	TITLE BOOK	AUTHOR	TYPE OF REFERENCE	
			Based on Source	Based on Tame
1.	Komitmen Dai Sejati	Muhammad Abduh	Secunder	Da'wah and theology activist advice
2.	Fiqh Dakwah	Jum'ah Amin	Secunder	Understanding of da'wah and theology
3.	Bagaimana Menyentuh Hati	Abbas As-Sisi	Secunder	Theology
4.	Lapis-Lapis Keberkahan	Salim A. Fillah	Secunder	Theology
5.	Dalam Dekapan Ukhuwah	Salim A. Fillah	Secunder	Theology
6.	Saksikan Bahwa Aku Seorang Muslim	Salim A. Fillah	Secunder	Theology
7.	Jalan Cinta Para Pejuang	Salim A. Fillah	Secunder	Theology
8.	Buku Pintar Mentoring	Tim Satu Asa	Primer	Mentoring guide
9.	Buku Modul Tarbiyah Islamiyah	Team of study institutions manhaj tarbiyah DPP PKS	Primer	Mentoring guide

Source: Independent research

From the table above, it can be grouped into two reference sources, namely primary reference and secondary reference. The book included in the primary text is the Smart Mentoring Book which contains guidance on being a good mentor along with tips and what should be done by a mentor and the Tarbiyah Module Book which includes the materials used at the time of the study. Through interviews with administrators, information was obtained that the *tarbiyah* (The Concept of Education in Islam) module book was not only used by da'wah activists at UNJ but was also used by other organizations with the same *tarbiyah* concept.

While the secondary references used are readings that make the soul booster and faith and arouse the spirit of da'wah, this is based on the understanding that one's faith is up and down so that it requires reinforcement from the reading that is the reference. In addition to the books recommended above, it is also directed to read similar books with the same concept, namely increasing the faith in the reader and harmony with LDK thinking.

Interestingly, some of the books above are generally popular and not classic books that are a reference in studying Islam. The theme chosen was more about strengthening the faith, which is the essential ability in understanding religion.

In addition to the books above, UNJ LDK activists or mentors are also encouraged to read other books that enrich their Islamic insights. Because they will face the mentees with all their thirst and questions when mentoring.

Besides being required to have sufficient Islamic insight, an activist was also encouraged to have a good reading ability of the Qur'an. The UNJ Dakwah Campus Institution (LDK) has a program that is quite interesting, and much in demand by its students, known as the Quran Institute or commonly abbreviated as QI. The Quran Institute is one of the places to study the Koran, namely improving the recitation of the Qur'an and memorizing the Qur'an. Students who take part in mentoring are advised to join the Quran Institute to strengthen their Qur'anic reading.

The reading class of the Qur'an or *tahsin* takes place once a week, which is adjusted to the schedule of the instructor and the group members. The group in question is a group with the same ability, and the instructor in question is those who could read the Quran well, and all students who meet these requirements are allowed to become teachers. Tahsin learning is divided into several levels, namely pre-study and *tahsin* 1-4. Students who have entered the Tahsin three group will be allowed to join as a teacher at QI to teach pre *tahsin* and *tahsin* one.

In addition to studying the Quran recitation, QI also accommodates Qur'anic memorizers. They are grouped in KPQ (Quran Recitation Group). They will be guided by students who have memorization. The KPQ learning process takes place once a week, namely on Fridays, after Friday prayers.

The results of the study are in line with the results of research conducted in 2017, by the Ministry of Religion's research and development institute which revealed that reading books read by LDK were more enriching in nature and increased Islamic insights and religious reading related to group tendencies. (Saefullah: 2017)

B. Attitudes and implementation of understanding

The understanding obtained by LDK activists from the study or mentoring were applied in the form of appropriate behavior from that understanding. It in line with the statement that religious education given to students can increase spiritual potential. (Mukhtaruddin, 2011: 133). One of the attitudes that appear is a suggestion to be actively involved in campus activities/organizations such as BEM and other Student Activity Units. The opinion is that LDK activists have a more excellent opportunity to spread the good and to expand the scope of da'wah.

An understanding of religious insight was shown by forming 10 UNJ Muslim cultures. Muslim culture must be carried out consistently by activists from the

UNJ LDK, and they are also obliged to transmit it and socialize it to other students. The socialization included covers the distribution of stickers, flyers, and paper leaflets using provocative slogans. The following Muslim culture formed by LDK activists as the basis for attitude and behavior is as follows,

1. SAW (Shalat Awal Waktu – Prayer for the first time)

This movement aims to make the UNJ community accustomed to performing prayers at the beginning of time and leaving activities after hearing the call to prayer. The behavior is evident when conducting meetings when entering prayer times, LDK activists will prioritize praying rather than continuing their meetings so that they can have the opportunity to pray in congregation in the mosque to achieve a higher degree of reward.

2. Tibas (Tilawah Bada Shalat- Reciting Quran after prayer)

The movement aims to make the UNJ community accustomed to reading the Koran after prayer even if only a few verses. By being accustomed to reading the Qur'an, it is hoped that it will always be close to Allah. The advice is especially recommended for students who have no activities after prayer.

3. SKS (Senin Kamis *Shaum* – Every Monday and Thursday doing fasting)

The movement aims to familiarize the people of UNJ to carry out sunnah fasting practices such as fasting on Mondays and Thursdays. It is recommended that LDK activists become accustomed to carrying out sunnah worship to arrange obligatory worship. The slogan that makes LDK activists always enthusiastic in carrying out sunnah worship is "if they are left they will lose the opportunity to get a reward."

4. SPD (Setiap Pagi Dhuha - Every Morning doing Prayer Dhuha)

The implementation of the Movement has similarities to the SKS movement (Monday Thursday Fasting) which is so that it can get used to doing the sunnah as exemplified by the Prophet. The implementation of the SPD is carried out before the learning process takes place, but still adjusting to the situation and conditions of UNJ students.

5. GT5S (Gerakan Tebar Senyum, Salam, Sapa, Sopan & Santun – The Movement of Spreading Smiles, Greetings, and Courteous)

This culture is applied as a characteristic that Islam is a gentle religion and loves one another with each other. So that it is expected that by applying this movement, students will have a good attitude.

6. Gemar Infaq (Gerakan Mari Berinfaq – The movement to like giving to people in need)

This movement aims to be able to help fellow human beings who are in need. So that it can train the UNJ community to care for others and the surrounding environment, and as a step to familiarize

students to invest in providing charity boxes in each faculty.

7. GST (Gerakan Setengah Tujuh- The Movement at the Half-Seven)

The aim of this half-seven movement is students, especially female students, to stop all activities in the campus environment when the time has been shown at 18.30 WIB. This movement is a preventive measure for Muslim women to avoid unwanted crimes.

8. J-Salim (Jumat berbusana Muslim - Friday Using Muslim Dress)

The J-Salim movement is a movement to get dressed in *syar'i* dress every Friday; dressed in Muslim dress. This movement was carried out as a form of da'wah to students who were not yet worn by the Islamic Shari'ah (Islamic Law).

9. Gemes (Gerakan Muslimah berhias Syar'i- The Movement to make Muslim women wear according to Islamic Law)

This movement is one program from the LDK UNJ to help Muslim women to cover their body according to Islamic provisions. While the campaign implemented by one of them is socialization the program by a parade. They also open a unique stand to offer a hijab to cover the body; the hijab which covers until the chest. This veil spreading movement is one of the projects owned by LDK and then revealed to LDF in each of its faculties.

10. GAM (Gerakan Ayo Mentoring- Movement to invite students to take part in mentoring)

This movement aims to encourage all UNJ Muslim students to take part in mentoring activities. To mentor itself, which is to discuss, share, and learn things related to religion. Their motto in holding this movement is a congregation in kindness, which means that in doing good, we must invite others.

10 (ten) cultures that have been formed are a reflection of the attitude of the UNJ LDK activists and are also an example for other UNJ Muslims. In the implementation of the UNJ LDK activists became the spotlight and role model for other UNJ Muslims. With these 10 (ten) cultures, UNJ LDK activists have become more disciplined and consistent in carrying out them. 10 (ten) UNJ Muslim cultures were socialized to new students during their interviews with the BEM Faculty. LDK UNJ also stressed it by opening a stand during interview activities by distributing pamphlets and stickers.

The 10 (ten) cultures above are ideally carried out by UNJ LDK activists. But for one reason or another, some sometimes cannot be entirely done. The challenges faced by LDK are because they are still in an atmosphere of classroom learning. Not infrequently, when the midnight call to prayer reverberates, knowledge in the classroom is still very active and has not yet been completed so they cannot perform the initial prayer time. Top-level policies are needed to be able to synchronize lecture activities with time to pray at the beginning of time.

On the other hand, not all students know the 10 Muslim culture of UNJ well. Even though it was introduced at the beginning of entering the campus, it seems that the socialization has not been memorable until it needs to be remembered.

Based on the above explanation, it can be seen that the religious understanding of the UNJ LDK Activist is based on the books read and also the studies attended; even though on the other hand, they are also required to read more to be able to answer other members' questions when mentoring. It is Seen from the type; it can be seen that their religious understanding is still a widespread understanding that can increase religious spirit and movement. Their knowledge is not yet at the stage that makes them able to analyze Islamic insights from the source. The statement refers to the absence of studies of primary sources of Islamic law, such as the learning of the Koran or Hadith. LDK activists study the Koran, but the focus is more on how they read and also how to memorize.

It is this basic understanding of religion that makes LDK a magnet for students who "migrate" to learn and learn about Islam; but not for those who need more in-depth insight. Students who need deeper Islamic insights generally prefer to be active in other Islamic organizations or communities such as the MATAN (students studying Sufism) and the PMII (Indonesian Islamic Student Movement).

With this level of understanding, the formation of habits is more based on patterns and not on full awareness. It is understood in the concept of reprimand for activists who leave 10 (cultural) UNJ Muslims. Interestingly, because activists must be role models for their members, then habituating 10 (ten) Muslim cultures eventually becomes a necessity.

CONCLUSION

Attitudes always correlate with thinking. With a good understanding, it is expected to have an impact on the formation of ethical behavior and views too.

The issue of religious radicalism is claimed because of the misunderstanding of religious teaching; on the other hand, it is also caused by a high level of religious enthusiasm, but it is not balanced with a qualified understanding of religion. Therefore, it is understandable why public universities are considered to be a hotbed for the growth of radicalism. This assumption is based on the fact that students who enter higher education mostly are students who do not have a deep understanding of religion but have a high Islamic spirit. The religious critical power of UNJ students has a close relationship with intrinsic orientation in themselves; the tendency in religion based on awareness in itself. One way to increase the level of intrinsic orientation can be done by following religious studies and studies. (Narulita, 2019).

This study tries to examine more deeply the activities of an institution whose task is to provide Islamic understanding to students at the Jakarta State University - Institutions that have clear structural lines and have units in each of their faculties. Also, this institution has a sound

regeneration system. The urgency of research refers to the status of the University, which is the teacher of the printer. Until that way, all the knowledge and understanding absorbed by prospective teachers would be very likely to be channeled and socialized to students and the surrounding community.

The findings indicate that the religious literacy of LDK activists who are considered to represent UNJ students is still in the primary stages. The study followed is a study with a popular theme, and the book used as a reference is a book that leads to movement; not deepening the Material and increasing self-awareness. However, for students who need a more profound religious understanding, they can participate in other Islamic organizations such as MATAN or PMII.

RECOMMENDATION

The level of religious literacy that has not been too high is an evaluation for the LDK UNJ. This basic understanding can be a magnet for those who are just learning Islam, but it seemed dull to those who had studied religion before. To anticipate this, the UNJ LDK can collaborate with other Islamic organizations to deepen Islamic material for its members. Besides that, the Quran Institution that was formed could be increased to a higher level; not just reading and memorizing, but arrived at a more in-depth understanding stage.

REFERENCES

- Allan, Menzies. (2014) *Sejarah Agama-Agama*. Yogyakarta: Forum
- Asep I (2011). Efektifitas Dakwah Fi'ah: Studi Model Dakwah pada Lembaga Dakwah Kampus. *Jurnal Ilmu Dakwah* Vol. 5 No. 2 Edisi Juli – Desember 2011
- Berger, Peter L. (1992) *A Rumor of Angeles : Modern Society ad The Rediscovery of The supranatural*. Jakarta : LP2ES
- Dinham, A., & Francis, M. (2015). *Religious Literacy in Policy and Practice*. Bristol: Policy Press. Bournemouth University.
- Hadiyanto, Andy. (2017). *Deradikalisasi Keagamaan Studi Kasus Lembaga Dakwah Kampus Universitas Negeri Jakarta*. Vol 01 (Nomor 01)
- Irfan (2019). *Masjid di Era Milenial Arah Baru Literasi Keagamaan*. Ciputat: of Religion and Culture (CSRC) Pusat Kajian Agama dan Budaya UIN Syariff Hidayatullah Jakarta.
- Mukhtaruddin. (2011) Pengaruh Pendidikan Agama Terhadap Perilaku Keagamaan Peerta Didik SMA Swasta di Kota Yogyakarta. *Jurnal Analisa*, 18 (1)
- Moore, Diane L (2006) "Overcoming Religious Illiteracy: A Cultural Studies Approach," *World History Connected* 4 (1)
- Narulita, S. (2019). Orientasi Beragama dan Implikasinya pada daya berpikir kritis mahasiswa UNJ. *Jurnal Online Studi Al-Qur An*, 15(1), 117-132. <https://doi.org/10.21009/JSQ.015.1.06>
- Saefullah, Asep. (2017). Bacaan Keagamaan Aktivistis Kampus di Universitas Negeri Jakarta (UNJ). *Jurnal Penelitian Pendidikan Agama dan Keagamaan*. 15 (2), 183-206
- Siregar, Emiraldo (2018) Perguruan Tinggi Terpapar Radikalisme, Retrieved April 14, 2019 <https://www.liputan6.com/news/read/3549087/perguruan-tinggi-terpapar-radikalisme>
- Tim Penyusun. (2016). *Pendidikan Agama Islam untuk perguruan Tinggi*. Jakarta: Belmawa RISTEKDIKTI
- Wahyudin. (2012). *Model Pembelajaran Transliterasi Sebagai Inovasi dalam Meningkatkan Kompetensi Warga Belajar Pendidikan Keaksaraan Fungsional*. Ringkasan Disertasi. Bandung: Universitas Pendidikan Indonesia.

Ladies Gym: A Mechanism Disciplining Woman's Body and Violation of Social Media Privacy

Anlia Yisca Kristiadi
Magister Communication Diponegoro University, Semarang,
anlia.yisca.kristiadi@gmail.com

Abstract - A fitness center called Elise Ladies Gym is specifically aimed for female consumers. The owner acknowledges there is a special need for women especially those who wear hijab to have exclusivity, so they can do their exercise comfortably without being seen by men. But in reality this fitness center then uploads various photos and videos of the activities of its customers while they are exercising at some social media for advertisement purposed. So that ultimately the privacy they have been promised before actually not fulfilled. The purpose of this paper is to see how women interpret their body shape and how the discipline of a woman body mechanism happened in the case of ladies gym. This research also looks about how social media plays its role in this mechanism process. This research use a qualitative research method of obtaining data through observation, and interviews. In this study it was concluded that women have the desire to have an ideal body shape. This self-disciplinary process is carried out like a closed training camp. Institution is one of the perpetrators of this thinking, but on the other hand it is actually only used as a marketing trick. The economic benefits are then obtained by inculcating this engagement through conventional mass media and social media. Some of Marx's concepts also manifest in the process of violating this privacy

Keywords: Disciplining body; Social media; Ladies gym; woman; Privacy violation

INTRODUCTION

On Tribun News May 7, 2018 there is a Success Story Rubric with the title "Helena Focus on Consumer Convenience". The leading news on this story is "Aim for a Special Segment and Understand Women's Gym Service Needs". Looking at this title, this news column wants to show the success of the women's gym business. This news become interesting because the headlines said "Aim for a Special Segment and Understand the Needs of Female Gym Services Users". This news lead firmly said there were "Special Segments" and "User Needs". So, the question, what kind of specific segments and what kind of needs are supported? If we read more on the body text, we will found when the Tribune asking the founder of this business with question, "Why choose women? Helena the owner of the Ladies Gym said that "In my opinion, not all women want to mingle with men while in a fitness center. Especially for women who wear hijab. They needs to keep their *aurat* (part of body required to be covered based on religious view). Therefore, I want the fitness center to be a

comfortable place for those who wear hijab. So they can do their work in comfort and not worry about man who can see them in an impolite way". From this statement we can concluded that what the word "special segments" means are women, and women with hijab. And what the word "user needs" means is a promised situation without the presence of men in this sport center. Woman in this case (the members of ladies gym) needs to do their sport activity, but they also needs a privacy place to do that activity. So, the concept of this ladies (only) gym became a fitness institution concept that attracted many women.



Figure 1. Success Story "Helena Fokus Kenyamanan Konsumen"

Source: Tribun News May 7, 2018 page 7

However, when we read more on the Tribune body text we can found about how Elise Ladies Gym do their business promotion. The owner answered that she also use social media to implement the Elise Ladies Gym. The social media that she use are Facebook and Instagram. On this social

media, she often share photos and videos about what they do. Here is the Elise Ladies Gym social media page

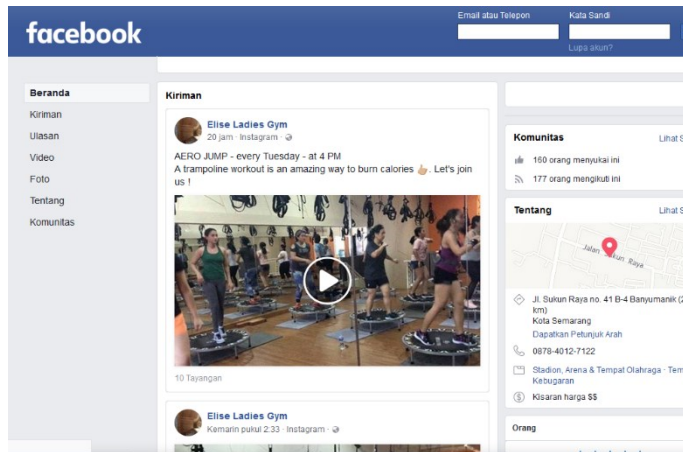

Figure 1. Facebook page Ladies Gym
Source: Facebook

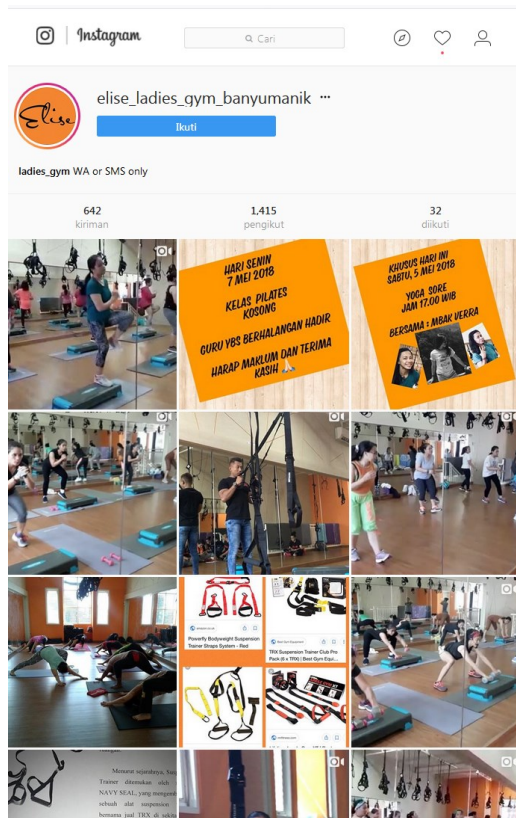

Figure 2. Instagram Ladies Gym
Source: Instagram

It's surprising when you see what's on the social media posts, it turns out that all sports activities are uploaded to social media. It can be concluded that what they have promised before about their members privacy was questionable. On Instagram, for example, he has a followers of 1,415 accounts, and his account is not private, this means it is very possible for every Instagram users to see the activities including the men.

So, the purpose of this paper is to see how women feels need to interpret their body shape and how the discipline of a woman body mechanism happened in the case of ladies

gym, how media, institution, and social media plays its role in this mechanism process. This research also looks how the Marxist concept of the internet studies is manifested in this case.

LITERATURE REVIEW

The Beauty Myth and Disciplining the Body

Naomi Wolf states that the quality about "beautiful" exists and applies objectively and universally. Women always want to be beautiful, while men always want to have beautiful women. There is a pressure arises from this situation, where man always want to have a beautiful woman. Finally, woman are intimidated by this pressure. This situation then manifests as something that is felt natural and necessary because it is biological, sexual, and evolutionary. Beautiful women are always associated with fertility, and since sexual selection has been applied, beauty has become standard (Naomi Wolf, 2004).

Foucault argues that women have experienced an internalization process about the definition of a woman's body which leads to "denigration of the female body". A process that makes a woman feel afraid, embarrassed or disgusted with certain parts of her body in a very natural process such as menstruation, childbirth and menopause. In turn, it is then placed as part of health conditions that require certain treatments. The existence of women in myths, stereotypes and domination of power. That the female body does not belong to the woman herself (Foucault Michel, 2008)

Marxism in Internet Studies

Christian Fuchs (2012) gives a critical criticism for Internet Studies and introduced key concepts in his analysis of internet practice. He discussed the role of eleven Marxian concepts for Critical Internet Studies. Marxian concepts that have been reflected in Critical Internet Studies include: dialectics, capitalism, commodification, surplus value/exploitation/alienation/class, globalization, ideology, class struggle, commons, public sphere, communism, and aesthetics. Fuchs also provides assistance with digital work.

State of the Art

Several studies on gender have proven the existence of a standard body of certain women constructed by society including women themselves. The research conducted by Endah Murwani (2010) on the Construction of 'Forms of Women's Bodies' in Television Advertising (WRP) shows that these advertisements not only inform food products and diet drinks, but also subtly categorize or classify the ideal female body shape . These advertisements create the reality of a slim, beautiful and healthy female body shape. The process of creating a system of categorization or classification of ideal body shape in the advertisement then also forms an awareness of reasonableness and the inevitability of ideal body shape for women. So that this study shows that there is a stereotype about women, namely the body that is considered ideal for women is lean, and does not have much fat.

In other hand, there are several studies about politic economy in internet studies. Christian Fuchs (2012) explains how Facebook uses unpaid workers (free labor). This shows that Facebook has practiced political economy, commodified audiences, and violated privacy to its customers.

Eran Fisher (2012) conducted a study of the existence of Audience Labor on Social Network Sites, and how they are alienated and exploited. This study compares how the mass media work system with social media. He took Facebook as his case study of social media and concluded that mass media had a high degree of alienation but had a low level of exploitation. High alienation occurs because the audience is only a passive consumer. While exploitation is said to be low because there are wages paid to workers instead. While on social media, the level of alienation is said to be lower, but exploitation is high. Alienation is low because it requires the role of the audience / consumer of social media in obtaining information. In the other hand, the level of exploitation is high because there is a need for a communication platform.

METHOD

This research is a qualitative research with data collection through interviews with ladies gym members and other supporting literature studies. This study emphasizes a critical perspective on internet usage. The data in this study were obtained by interviewing several members of the ladies gym at random. Asked questions regarding the decision to join this institution and how they responded to the ladies' gym social media. The interview data is then interpreted into several presentation of critical marx concepts to internet studies to draw research conclusions.

RESULT AND ANALYSIS

Woman feels need to control them self

In line with the research described earlier, the results of the interview concluded that women think (1) the ideal body of a woman is thin and slim. This was revealed by the research subjects as a natural thing. Even for those who are in the postpartum period, they still have to try to restore the body. This was said by one member who only gave birth 3 months ago.

(2) Women are also required to protect themselves in the form of dress and their behavior so that they do not invite male lust. The subject research explained that sportswear was tight clothing and not worth seeing by men. Movements made during exercise (especially Yoga style will often show the part of their buttocks). Two research subjects used hijab every day, and they said that the need for exercise should not exclude their modesty in dressing. For that they chose the ladies gym because there were no men in the gym. This is expressed as a process of guarding oneself from male lust.

Discussions on the issue of headscarves and veils are still very interesting to debate in Indonesia. Women feel the need to wear headscarves and coating to protect

themselves and avoid male lust. The situation was created that women must also protect / save their bodies. On the other hand, men's passions are never blamed, women who cannot take care of their bodies and attitudes in a polite manner, they will always blame them for sexual harassment.

Women are always maintain their politeness in their way to dress and their attitude to keep their body save from male arrogance.

In the case of ladys gym, this was responded by the institution about the presence of the exclusive concept of a fitness place. Women here are interested in the lure of a "women's-only gym". They (the members) feel comfortable when what they do there is not seen by men. They don't want their ugly body shape to be seen by men, they also don't want to when they exercise and wear tight clothes and move with movements that might invoke this male's lust seen. In the end women isolate themselves without realizing it.

Actually critical gender studies see that there are inequalities where women must maintain their genitals while men do not. Men are free to see women, men are not blamed when they later arise sexuality lust for women. Women will be blamed for not being able to maintain their bodies properly.

Women as Objects of view

When the dominant idea of the "ideal" body of a beautiful woman is that is thin and does not have much fat is in the minds of women, then women feel the need to work on their bodies to be thin / slim. This phenomenon of ladys gym illustrates how women need sports activities to meet the needs of the identity they expect.

Some of the member said that they do their work for health reason, but interviewing with one of the respondent regarding the reason for participating in this fitness center, she said "I am in a post giving birth periode so my weight is over now, I have to do this work for bring my first weight back. If I don't do the exercise, I can't lose my weight. "

She felt that her weight in this period is a something bad, and she needed to restore her weight as before pregnancy. Actually, as quoted from Kompas.com that argue when women during pregnancy until she giving birth, most new mothers will indeed experience a fairly drastic increase in body weight. The increase in maternal weight during pregnancy is a natural thing because of the baby in the stomach and amniotic fluid. Most of them want to lose their weight but actually an excessive diet, is also not good because these new mothers still have to give breast milk after giving birth, so health needs to be maintained.

Based on the examples of these respondent clearly show that they do the work is not only for health, but rather in the hope of an ideal body shape. Childbirth is actually a natural one for women, but then women feel disgusted with their bodies after giving birth so they need special treatment to reduce weight and restore the body shape they consider to be ideal.

Here then it can be concluded that women are objects of view. What can be highlighted by women is the ideal body shape, and other physical beauty. A smart women, rich, good careers, will still want to have an "ideal" body to be appreciated by others, including men. When the dominant of "ideal" body is slim and thin, then women always feel the need to discipline themselves. Therefore this false awareness makes women diligent in exercising to get the ideal body.

The application of this understanding was carried out and manifest in women's beauty election events both at the local, national and international levels. In the local domain, for example the election of Denok Semarang, Mbak Wonosobo, None Jakarta, in the National realm such as the selection of Miss Indonesia contest, Putri Indonesia contest, Putri Muslim Indonesia contest, in the international area such as Miss World and Miss Universe all require women not only beautiful but smart and able impact. The fact is that physical aspects are still important in this kind of election. In those woman beauty election always treat their contestan to do their catwalk. Catwalk always mean to show a physical beauty. So what kind of beauty was accepted? In dominant idea, almost people think that beauty is slim and thin. So, all of the contestan or candidates are selected also by their body shape. Maybe not only body shape requirement that the candedates has have, they also have to be a smart girl. But how smart they are, if they are not beautiful or do not have an ideal body shape, they will not be finalists.

Never Satisfied

Some respondents said that they had personal targets for losing their weight. For her, the target is important because it can be a spirit booster for not being lazy to do the exercise. Sometimes they also tell each other about their fellow members. The goal is to motivate one another, especially when her friend has succeeded in losing weight and reach her target, so there is a stronger desire to another members to get the same results.

Uniquely then is when the target of weight loss has been fulfilled, they feel happy and satisfied to be motivated again to have a new weight loss target. In fact, some members decided to add hours of treatment outside of the usual duration of treatment they used to.

This fact shows that in the end women will never feel satisfied with their body shape. It can even be said that they always feel anxious if other people have a better body than themselves.

Like a Training Camp

On the other hand even this institution is said to be an isolation space for women, this fitness institution states itself as a place to make improvements for a closed training female body. Women don't want this training process to be seen, of course because this process is not worthy to watch by people. Women with fat bodies do not want the disciplinary process of their bodies to be seen by others. This is like a training camp where someone spends several time to undergo a series of closed training to produce something new. Only she and the trainees may be in the

training camp. While others can only see the results of training, which is the ideal body shape.

Other analogies are the rear kitchen. Some of the designs of luxury homes usually have two types of kitchens. Front kitchen and rear kitchen. The rear kitchen is usually used to cook food, it will look more dirty, while the front kitchen. The front kitchen is usually only used to prepare food that has been mixed before in the rear kitchen. When the owner of the house wants to invite their guest for dinner, of course they are not allowed the guest to enter the rear kitchen. Guests are usually only allowed to enter at the dining table or in the front kitchen. The home owner will not allow his guests to enter the rear kitchen because there is usually dirtier, and they will be embarrassed if the guest judges the kitchen is dirty.

This analogy is used in the Ladies gym thinking system. How the process of self-discipline is seen as a process that is "dirty" and not worth seeing by others. Other people don't need to know how the process is done, often the reason is because they are ashamed of their body shape. When women will walk in the public sphere, they will seek the "ideal" appearance.

Marketing Tricks Merely

In the end it was concluded that these "special segments" and "customer needs" were merely marketing tricks. Like advertisements that focus on halal labels on products to attract public sympathy for products sold, even this institution does the same. This institution sells what has been dominantly constructed in society that women must fulfill their needs and form exclusivity. This thought was then sold to bring benefits to women who wanted to be exclusive in disciplining themselves.

In addition, this marketing trick is also said to be successful, when in the end women who have got the body shape they want, want to increase the hours of practice to get a more "ideal" form or just maintain it. Several respondent claimed that they felt need to continue to take more training class program to maintain their existing weight. Automatically the members finally depend on this institution, and even this institution can gain financial benefits from the perspective of its members.

Strengthened by Media

In addition to institutions, the media also plays a role in this perpetuation process. One example of the Central Java edition of May 9, 2018 page 9 makes a rubric with the title Success Story for the Elise ladies gym institution. Then the news lead wrote "Aim for a Special Segment and Understand the Needs of Ladies Gym Service Users". This means that the media agree that the success story of this fitness institution is due to the existence of special segments and user needs facilitated by an exclusivity. In the end the audience or reader judges that there is truth in this matter where women need this institution to achieve its goals. This is just one example of how the media reproduces this ideology, out there a lot of media has proven to be a perpetrator of the ideology of domination of women. In the

end, women see their bodies not ideal and feel anxious and feel they need certain treatments

Violation of Social Media Privacy

Another interesting part of this research is when looking at the social media of ladies gym. Social media is claimed by fitness center owners as promotional media, but on the other hand it violates the privacy of its members. Instagram followers in the women's gym are more than 1000 people, meaning those who see all admin posts are more than 1000 people including men. This contradicts the promised privacy labeled "exclusively for women" and with promises that are not seen by men.

Based on this, they actually have an obligation not to show what is in it for promotion. They also do not ask permission from members who being subject market materials on social media.

Internet and social media bring changes in various systems of life. Fuchs' research was carried out on the Marx concept that was applied in the use of the internet and Facebook as one form of social media which then showed 11 Marx's concepts in the practice of social media in a new form.

In this case some of Marx's concepts also manifest. (1) Commodification, occurs in the form of labor commodification. When the ladies gym Instagram and Facebook contains the activities of the members, at the same time the members are said to be the subjects of the ad. Commodification occurs when what they are actually members / consumers / clients, changes to the subject of advertising. This brings huge benefits to the ladies gym because they don't pay them as advertising subjects, but they use them as the subject of promotion.

This can be said as a practice (2) exploitation where they should be paid by the ladies gym as the subject of advertisements, but in fact even this ladies gym never asks / asks permission for its members to be the subject of advertisements on social media. The members seemed to be laborers for this gym institution that was exploited and alienated. They did not get the surplus value obtained by the ladies gym. The next concept of Marx is about (3) alienation, this concept describes the estrangement of people from products as a consequence of living in a society of stratified social classes. The mechanics of a social class, the condition of which is a person from their humanity. This promised privacy violation is one manifestation of how alienation occurs in this ladies gym client. They also did not realize that they had been used as subjects for unpaid advertising. This is leads to the concept of (4) Marx's capitalism which emphasizes those who carry out exploitation and alienation. This institution has become a capitalist class that has benefited by utilizing social media as a promotional tool with wide reach. Economic benefits are the main thing in this process. Gain as much profit as possible with small capital utilizing the members and their activities as advertising content.

Some of the subject research feel there's nothing wrong with uploading activities in this fitness center into social media. They also don't mind if they are on the ladies' social media. They feel that social media is a form of community, which brings benefits to finding fellow members there, exchanging information, and so on. Social media is used as a tool for self-existence in the ladies gym community, when the fitness class video is uploaded, the members on the video can comment on the comments column, they also claim to get more followers from other fellow members. This thought shows how (5) ideology is present as a false consciousness. Marx argues that ideology is a tool for reproducing capitalists. In this case, the members did not mind their photos / videos circulating on the ladies gym social media as the subject of the advertisement. They feel that they benefit as a form of self-existence, and also they find each other in the community. But actually this is a violation of privacy carried out by the ladies gym to its members.

If previously Fuchs accused Facebook and social media as capitalists, this study saw that capitalism in social media space was not much different from real sociality. The institution becomes the capitalist who exploits labor, but the use of social media becomes a tool used in the practice of privacy violations.

CONCLUSION

The ideal body shape for women is a thin and slender body, this is a prevailing understanding in the dominant society. The ladies gym members also acknowledge that their need to exercise in that place is solely not only for health and fitness but also hopes for an ideal body shape. They want to follow the dominant "ideal" standard in society. In the process, they made this fitness center serve training camps where they did not want what they did in seeing people. They only want other people to see the results achieved by efforts in this fitness center. In the end this concept was adopted as if not aware of fitness institutions as a marketing trick. Where he sells his segmented fitness place for women and serves the special needs of women, namely the exclusivity of men's views. In this case it was also seen that the institution later became one of the ideological perpetrators that women had to discipline themselves and in the end he would never be satisfied with his body shape. On the other hand, the media has also become the center of widespread dissemination of ideology, namely by labeling the construction of all forms of information to the public. It's become more complicated when social media were used for media promotion to this fitness center. On the one hand they provide special labels for women and promise exclusivity, but on the other hand they show how female members dress and exercise on social media followed by more than 1,000 people including men's accounts for promotion reasons. This process in view of Marx's concept is a form of commodification of labor in which there is exploitation and alienation to the members carried out by the institutions of the ladies gym as capital. This process is perpetuated by false thoughts and awareness that it is not

realized that this is a violation of privacy that is used as a medium for this women's gym promotion.

RECOMMENDATION

In this study it was seen that women's gyms violated privacy. The privacy promised to the members has not been fulfilled. If the owner says that the gym is specifically for women and that women get comfort in exercising by not being seen by others, then this institution has been violated through various social media promotions. The social media of the institution clearly shows that its members are exercising there. Many members are not worried about this because they do not realize it, so literacy of the privacy of social media seems to be something that needs to be considered.

On the other hand I also highlight how women see their body shape. Education is still needed to provide an understanding of this. How not only women, but everyone needs to understand how the ideal idea of women's body shape is false awareness. So that in the end women are expected to have freedom and equality.

REFERENCE

a. Book & e-book

Foucault, Michel (2008). *Ingin Tahu Sejarah Seksualitas*. penerjemah Rahayu S. Hidayat. Penerbit Yayasan Obor Indonesia dan FIB Universitas Indonesia: Jakarta

Wolf, Naomi (2004). *Mitos Kecantikan: Kala Kecantikan Menindas Perempuan*. Niagara: Yogyakarta

Fuchs, Christian and Mosco Vincent. (2016). *Marx in the Age of Digital Capitalism*. Koninklijke Brill NV, Leiden Boston

b. Journal, thesis, dissertation

Muwarni, Endah. (2010). *Konstruksi 'Bentuk Tubuh Perempuan' Dalam Iklan Televisi*. Jurnal Ilmu Komunikasi, Volume II, Nomor 1, Juni 2010

Fuchs, Christian. (2012). *The Political Economy of Privacy on Facebook*. Television & New Media 13(2) 139-159

Fisher, Eran. (2012). *How Less Alienation Creates More Exploration? Audience Labor on Social Network Sites*. tripleC 10(2): 171-183, 2012 ISSN 1726-670X

Fuchs and Nick Dyer. (2012). *Karl Mark @ Internet Studies, New Media & Society*. Volume: 15 issue: 5, page(s): 782-796

c. Newspaper

Tribun Jateng edition May 7, 2018 page 9

d. Website Material

Instagram account of Elise Ladies Gym
<https://www.instagram.com/explore/locations/179244885865410/elise-ladies-gym?hl=en>
 Facebook account of Elise Ladies Gym
<https://www.facebook.com/Elise-Ladies-Gym-179244885865410/>

Islamic Masculinity in Indonesian Islamic Movies (The Representation of Men and The Practice of Men's Power in Indonesian Islamic Movies in The Post New Order Period)

Muria Endah Sokowati

muriaendah@umy.ac.id

Universitas Muhammadiyah Yogyakarta, Indonesia

ABSTRACT- Islamic masculinity constructs men based on a variety of religious and social structures. It is embedded within cultural institutions in the Middle East, which conditioned by a patriarchal society that exercises control over women. Islamic discourse in Indonesia was subordinated in the new order period, but it started to grow since the 1990s when Suharto felt that he was losing military support. The revival of Islam after the new order period has provided Indonesian men with alternative masculinity. It can be drawn from Islamic or religious movies that succeed in attracting the audience. This article analyzes how Islamic masculinity is constructed in the Indonesian context based on the representation of Indonesian men in Indonesian Islamic movies in post new order period. This article used textual analysis as research methods. It does not only describe how men look but also explains how the practice of domination of men over women narrated in Islamic movies.

Keyword: Masculinity, Gender Ideology, Islamization

Introduction

The movie industry in Indonesia in the post new order, which has dormant for nearly ten years, is eventually revived. The revival has driven the production of movies in various genres, including Islamic film. Islamic film has an Islamic culture and values as the background of the story. This type of movie is desirable to the audience. For example, *Ayat-Ayat Cinta (The Verses of Love)* produced in 2008, was successful in attracting 3 million viewers only in three weeks screening. The same type of movies followed the success of *Ayat-Ayat Cinta* and also capable of being viewed by a broad audience. The production of Islamic themed films brought to the emergence of a new genre in the movie industry in Indonesia, which often called religious movies or Islamic movies.

The themes of Islamic films adopt Islamic culture and values, such as the problem of gender, the clash of Islam and global issues, the implementation of Islamic values in everyday life, etc. This genre's booming is responded positively, especially from *ulema* (Islamic religious leaders), since these movies are able to spread what they considered as Islamic values so that it will possibly recover the perception of Islam among non-Muslims after the 9/11

bombing. However, some people still concerns about the controversial content in movies like polygamy or conservative religious messages because movies like other mass media become a capable vehicle to promote ideological ideas through iconic cultural symbols in its contents. Out of the pros and cons, religious films turn out to be promising commodities since they have their segments. *Ayat-ayat Cinta* became a phenomenon since it could bring religious communities to visit theaters and to watch this film. The examples of the religious communities are members of women's religious groups, students of Islamic boarding school, religious leaders, and people who mainly avoid mall or theater for their being 'not-so-Islamic'. Among those themes adopted in Islamic movies, the idea that quite often appeared is gender and its problems in how the representation and performance of men, the relationship between men and women or men and other men, and the gender roles based on Islamic values become exciting topics to discuss.

This paper focused on how the Islamic movies portray the problem of gender, especially on how the representation of men and the practice of men's power. Two reasons motivated the attention of men. First, the study of men and masculinity in the Indonesian context is still rare up to now, and second, Islamic movies in Indonesia in the post new order had built the new discourse on how to be a man. During the new order era, as an authoritarian regime, Indonesian society was faced with the dominant discourse of masculinity. The fall of this regime brought alternative discourse of men, which was encouraged by Islamic culture and values, and it was performed in Islamic movies. Indonesia is not an Islamic state, but as a country with 80% Muslim population, Muslim men in Indonesia construct their identity based on Islam as a religion. The construction refers not only to *Al-Qur'an* as a holy book but also from the cultural, social, and political background situated in Indonesia. The representation of men in Islamic movies relates to those backgrounds.

Theoretical Framework

Masculinity: Social Construction of Men

According to Connell (2000:29), masculinity is the form of gender practice as the product of social construction. Masculinity refers to male bodies directly and symbolically

but is not determined by male biology. For Connell (2005:71), masculinity is understood in the reproduction arena to explain that the body is not a fixed and innate fact or biologically determined, but rather the historical process. Masculinity is placed in gender relations as the practice involving men and women and implicating in bodily experience, personality, and culture. Morgan (in Beynon, 2002:7) explained, "*what is masculinity is what men and women do rather than what they are.*" As a construction, masculinity doesn't only refer to men, but also women.

It seems that men and masculinity relate to each other. It is logical since biological assumptions influence the concept of men and masculinity as to the standard of being a man. The man considered normal if he is aggressive, sexually active, or rational. It becomes the natural way to be a man. Lionel Tiger (2005), in his phenomenal book *Men in Groups*, offered the theory of masculinity, which based on the idea that men come from the hunter species. According to Tiger, the male body brings the natural masculinity produced by the evolution process. Thus, men inherit masculine gens: the tendency of men to be aggressive or competitive. As a result, if a man doesn't have a certain characteristic, he won't be considered as a real man. A male homosexual doesn't refer to the real man since he has a particular hormonal deviation that makes him different from the normal men.

This point of view contrasts with the concept of masculinity based on a cultural perspective, explaining that men and masculinity are not a universal concept (Brittan, 1989:1). Masculinity is a construction defined by cultural, historical, and geographical perspectives. It implicates on the complexity of the definition of masculinity. According to Kimmell (2005:25), masculinity is a set of meaning, which is fluid and explains about manhood, so that it has different definitions according to different people and time.

The definition is determined by particular references accepted by the people at a certain time. In a culture ruled by heteronormativity, men have a sexual orientation to women. They take it for granted. Of course, it is not an absolute and everlasting belief. Some various ideologies and discourses influence and modify the notion of heteronormativity.

Therefore, there is no fixed and universal or even original definition of masculinity (Reeser, 2010:18). If a bodybuilder mentions Arnold Schwarzenegger, an action movie actor, as the icon of masculine man, so he becomes the duplicate of Schwarzenegger by performing his muscles as Schwarzenegger looks like. Schwarzenegger can be the duplicate of the other men, such as Hercules, in Greek mythology. Between Schwarzenegger, the bodybuilder, or Hercules are different from the "original." Masculinities performed are hybrid. There is always a reproduction of masculinity, whereas one particular form is modified into another.

The variation of the construction emerges the plural masculinity as long as the plurality of societies that are classified into various dimensions: race, ethnicity, religion, social class, age, social status, the level of education, et cetera. Consequently, there is the complexity of the relations between each type of masculinities. Therefore, Connell (2005:77-79) divided the pattern of masculinities based on the practices and relationships between types of masculinity. It is called hegemonic and subordinated masculinity.

Hegemonic masculinity refers to the definition of masculinity constructed by the dominant culture. This definition is legitimized by a patriarchal culture that guarantees the dominant position of men over women. When the ruling regime changes, the new regime constructs the new hegemonic concept of masculinity. For example, when the regime of military rules, the military masculinity becomes hegemonic. The fall of this regime, replaced by the more capitalistic regime, brings to the emergence of a new masculinity, such as the trend of metrosexual men. Subordinated masculinity, as the opposite, represents subordinated men in society. Male homosexuality is often discriminated and excluded politically, socially, and legally and becomes one of the examples of subordinated masculinity.

The Concept of Islamic Masculinity

The discourse of men based on Islamic culture and values relates to the concept of Islamic masculinities presented by Lahoucine Ouzgane (2016). According to Ouzgane, Islamic masculinity discussed the construction of men within Islamic discourse, describing men from the Middle East perspective as the Islamic states. It adopted the social construction of masculinity that positioned men in the frame of social structure and religiosity (Ouzgane, 2006:2). He underlines that this perspective based on a social constructionist view, which assumes that men are not born but made. The masculinities of men are constructed within a particular social and historical context. Thus, according to the Islamic context, masculinity is described as a set of attributes, behaviors, and roles distinctively practiced by men within various religious and social structures.

Ouzgane emphasized Islamic masculinities as the concept to illustrate the plural images of men. The term Islamic doesn't suggest a single description of a Muslim man. In his book, he explained the un-generalized experiences of masculinities practiced in Arab, Yemen, Egypt, Palestine, Iraq, and Morocco. The use of the term "Islam" is often problematic since it is used by the west to define Islam, which implicates the single and uniform perspective of Islam. Edward Said in *Covering Islam* (1997) has already criticized this fact. He stated that west only simplifies Islam, that is consisted of numbers a billion people, dozens of countries, societies, traditions, languages, and numbers of different experiences, into a small proportion (1997:xvi).

Based on this misleading assumption, Asef Bayat (2003) differentiated the term Islamic society from Muslim society. He defined Islamic society as the society that has placed Islam as the central factor to shape its dynamics. The definition describing Muslims and their culture are constructed by "others" (for example, from west perspective). It is parallel to Said's claim that others' descriptions of Islam has brought to the unitary image of Islam. Based on this perspective, the concept of masculinity is influenced by the fundamentalist movement, which declares to practice what they calls as pure Islam. The depiction of Muslim men followed to the concept of *jihad* and *Shahadat*, which leads to the struggle of Muslim men to fight against the threats of Islam (Gerami, 2005:452).

In contrast, Bayat explained that Muslim society is as plural and concrete entities. Muslims, as agents of their societies and cultures, defined their society. Thus, Muslim society is a concept used to describe the dynamic reality of society under the Muslim perspective. Based on this perspective, Gerami introduced Muslim masculinities as the product of the various construction of masculinity (2005:453).

Textual Analysis As The Research Method

This research method is textual analysis. According to Frey, Botan, and Kreps (1999), textual analysis is the research method focusing on the description and interpretation of the text. The text can be recorded or visual messages. Researchers working in mass communication, cultural studies, or media studies often use this method to analyze the content, structure, and functions of the text. Since this method has an interpretive function, it pays attention to denotative meanings and tries to examine the implicit social meanings or the connotative meaning. Therefore, this method can help the researchers to reveal the ideological message behind the text.

This research focused on the two Indonesian Islamic movies produced during the post-new order: *Ayat Ayat Cinta/The Verses of Love* (2008) and *3 Do' a 3 Cinta/3 Prays 3 Hopes* (2008). I choose these movies not only based on the fact that they have succeeded in attracting the audience, but is also motivated by the reason that these movies' central of the story are about men, their characters, roles, and their relationships to women. Thus, the two movies becomes the best locus for analyzing the Islamic masculinity as my point of interest.

The analysis started with the identification of the elements of movies, shots, and scenes that portrayed the images of men. The chosen elements are explored by relating the images, dialogues, and aesthetic strategies used by the movies. The intertextuality is done to understand and reveal the hidden message or ideological meaning. The analysis also included the relation between text and social and political context. Discussing Islamic masculinity cannot be separated from the historical context of the process of Islamization in Indonesia during and post new order.

Islam Under and After The Authority Of Suharto

The new order era begun in 1966 was an authoritarian regime governed by Suharto. His superiority was supported by military force and influenced by the Javanese tradition. He held his power and authority in an extended period, about 32 years. During that time, he controlled every aspect of life formally through his legal policy and informally through discourses to regulate people's behavior to support his authority to maintain and stabilize his domination. How he controlled the press and constructed, gender ideology were the examples.

This regime continued previous government policy, which excluded the Islamic group as a socio-political movement. The exclusion of Islam was started after Indonesia's independence when the new state was built its ideology. The Islamic groups proposed the implementation of *Sharia* Islam or Islamic law by mentioning it in the state's ideology. The Islamic group's proposal was rejected with the consideration that Indonesia was not an Islamic state. *Pancasila*, then, was declared as the ideology of the state to accommodate the plural ethnicity, culture, and religion in Indonesia.

In Suharto's authority, the confirmation of *Pancasila* as the only state's ideology had excluded Islamic organization from the political system in Indonesia. The existence of Islamic organization was independent and non-affiliated to any political interest. This situation brought to great disappointment with Islamic groups. They strove for resisting the new order's political power by using student's *dakwah* (Islamic teaching) in university campuses to promote their ideas and raise forces. The Islamic organization was formed with varied ideology, some developed vision of tolerant and liberal Islam, which were compatible with democracy; the others can be described as fundamentalist and anti-democratic (Collins, 2007:154). Iranian revolutions in 1979 inspired students from Islamic organizations to make Islam as a political movement. But, Suharto destroyed the effort by taking the Islamic organization's leaders into jail. The student's demonstration was attacked by military force.

The revival of Islam began at the end of Suharto's authority in the 1990s when he lost military support. The government then supported Islam by approving a new Islamic organization called ICMI or The Association of Muslim Intellectuals. According to Vickers, ICMI was designed to attract the middle class as an influential new group. Soon, ICMI was a success in accommodating the aspirations of many Muslim communities (2005:200-202). New order gave Islamic courts jurisdiction over marriage, inheritance, and donations (Collins, 2007:157). Suharto also went on the hajj that confirmed his attention to Islam. The support of Suharto to Islam was a success in creating significant change in the way Islam was express in public (Robison in Handajani, 2010:96). The increasing number of women who wore headscarves and the emerging of Islamic popular culture, such as novels, television programs, soap operas, songs, etc. can be considered as the significant indicators of how Islamic identities expressed in the public sphere.

Suharto's authority was fallen in 1998. The post new order gave opportunities to Islamic groups to develop to be a social or political movement. There were many Islamic groups with a different ideology, from liberal and democratic to radical and militant, which advocated the state to adopt Islamic law. This situation also provided people to adopt the Islamic way of life. For example, people used Arabic terms more often, or more Muslim women wore headscarves. Some constitution was produced based on Islamic norms and values. *Sharia* laws in a particular region and pornography act were the examples of the constitution made by its spirit.

This situation inspired the marketer to create a religious marketplace. Religious marketplace in Indonesia also encouraged by the need of the middle-class consumer to consume the product based on religious reasons.

The transition of the New Order to the post-New Order regime resulted in the media liberalized policy in 1999. The new media policy had disengaged the government to control the media. The Act num. 40/1999 was legalized and implicated to the revocation of the Minister of Information's Regulation num, 1/1984, about the cancellation of the Press Publishing License. The media liberalization and industrialization implicated the emergence of new media, which exploited women's bodies and sensualities, sex, pornography, crimes, or scandal. This situation had worried about the middle-class society because the media had westernized and secularized the Islamic values (Widodo, 2008). The media had encouraged moral degradation to the audience so that it kept them away from tradition and religion. This situation brought to moral panic, which had decreased the traditional value and caused religious disorientation. The loss of religious identity encouraged middle-class society looking for sources to bring their identities back.

The increasing of people's awareness of Islamic values creates the potential market for Islamic cultural products and trends. More Islamic schools from kindergartens up to universities are built; the products with Islamic label are marketed, and still, Islamic pop cultures got more popular. It is the booming of Islamic popular culture, including Islamic movies.

Discourses Of Islamic Masculinity

The authoritarian regime in the new order period in Indonesia implicated in the acceptance of hegemonic masculinity, which oriented Suharto's figure. The construction of ideal men represented the figure of Suharto, who proclaimed himself as *Bapak Pembangunan* (the father for development). He raised himself to the level of the omnipotent father of Indonesia. The depiction based on the Javanese and military tradition that symbolizes 'father' as a man who has power over his wife and children. In the new order, political power 'father' dominated his loyal followers. This relation was called *bapakism* (Pye dan Pye, 1985:306).

Bapakism was the character of ideal masculinity that dominated women and other men under his domination.

Suharto embedded the hegemony that his authority was given from God unquestionably (Clark, 2004:118). He had charisma performed from his calm and authoritative traits, which showed his rationality or the quality of logic. This ideal character contrasted with other characters, youth, for example, which considered subordinated since it prioritized emotion than reason (Nilan *et al.*, 2009). Hegemonic masculinity in Indonesian culture emphasizes on inner traits, what Nilan called as *moral/personal self-regulation*. This construction is different from the west conception of hegemonic masculinity, which accentuated physical aspects or corporeal self-regulation (Nilan *et al.*, 2007:10).

Islamic masculinity emerged along with the current revival of Islam. Muslim men who are subordinated in a new order period gained their power through Islam as religion. According to men's interpretations of *Al-Qur'an*, Islamic masculinity give men a special position in society since men had authority from God to govern the world (Handajani, 2010:98). Men are a leader in the family, in their work, and in their social life.

Towards the end of Suharto's reign, encouraged by the current revival of Islam, the expression of masculinity shifted from secular to religious perspectives. Handajani (2010:98) stated, "*Indonesian Muslim men who were subordinated during the new order using their religion to perform their masculinity. By using the masculine interpretation of the Quran, they performed their male superiority.*" Indonesian men performed their masculinity and power into two cases:

The Practice of Polygamy

Under the authority of Suharto in the new order period, polygamy was strictly limited through its policy represented conjugal couple and the nuclear family as the ideal family. It was prohibited for a civil servant to have more than one wife. Doing polygamy was labeled as shameful and backward. The period after Suharto, people performed polygamy openly. For example, the vice president, Hamzah Haz, stated that he had three wives. The president, Megawati, the only female president in Indonesia, never complain about that his father, the first president, Sukarno, also did polygamy. Some public figures in Indonesia, such as celebrities, religious leaders, business people, or state officials, never hesitated to show their practice of polygamy. In 2005, a polygamy award was held by Puspowardoyo, a successful businessman who had four wives to reward men who success in practicing polygamy. For men who are practicing polygamy, it becomes the natural consequence of men's sexual desire. Polygamy is the solution for men to regulate their sexual desire and avoid adultery.

The practice of polygamy in Indonesia is not only a form of male domination over women but also a vehicle for Muslim men to strengthen their position in the rise of Islam as a

political force in the 1990s. According to Van Wichelen (2005), polygamy for Muslim men is the act to reaffirm masculinity rather than to build their Muslim identity. Handajani also mentioned that polygamy is the way for Muslim men to exercise their power by using Islam to resist the new order version of being a man (2010:98).

Islamic youth group's hypermasculinity

Another masculine image is performed by Islamic youth groups whose missions are to uphold Islamic norms and values against courses of action that diverged from those. They conducted their mission by using violence. The movement of Islamic groups operated openly since the fall of Suharto. In November 2000, a group of people on behalf of Islamic groups called Gerakan Pemuda Ka'bah/GPK (Ka'bah Youth Movement) attacked 350 gays and male-to-female transvestites who joined a kind of artistic performance in Yogyakarta. This attack caused twenty-five of them were injured, and three persons were hospitalized. The witness described the attackers as full of emotion, filled with anger, wild, and hot-tempered. Boelstorffs described this action as *political homophobia* because of the hatred of non-normative men in Indonesia related to cultural, sexuality, and political violence (Boelstorffs, 2004). *Front Pembela Islam* (FPI), another Islamic group, destroys buildings that they considered immoral, such as the pub, karaoke, and billiard houses, is another example. They also attacks people who have different ideologies with them, including homosexuals and transgender. Both FPI and GPK use the same manner to work on their mission, violence.

Boelstorffs (2004) stated that by using violence, the norms of Indonesia's national identity gain new masculine acts, in terms of Islam. In the case of the rejection of Islamic groups to male homosexuals and transgender by using violence is not just the way they express their religious beliefs, but also the reaction of the feeling of shame Boelstorffs (2004) related this to national identity. The sense ashamed is encouraged the Islamic groups since the non-normative men challenged a nationalized masculinity. The feeling ashamed draws the Islamic group to act public violence to show their masculinity.

FPI, GPK, and other Islamic groups attracts young people to join and act violently. According to Connell (2005), when young people from the middle class are able to meet the ideal of masculinity with education and career, young people from the lower class are difficult to achieve. The poverty is estranged them from pride, and it got them bored. This condition motivated young people from the lower class to join groups that acted violence, destructive and aggressive (hypermasculinity). Nilan (2009), who researched gang and violence in Indonesia, including Islamic groups, found that the jobless and lack of masculine indicator triggers young people to conduct violence. The Islamic groups' homophobia and their hypermasculinity in the name of religion. These groups constructed the normative gender discourse, which conceived homosexuality as deviant and destroying Islamic values.

Islamic Masculinity In Cinema

Ariel Heryanto (2014) argued that there is a difference of Islamism in Indonesia before and after the new order. While Islamism in the new order period applies to formal political institutions, Islamism after the new order ensued in the popular culture. Industrialization and liberalization of media in Indonesia in the post new order period encourages the booming of various types of popular culture. The interesting thing is how these popular cultures expose Islam as content. Islamic books, Islamic soap operas, Islamic fashion style, Islamic songs, Islamic movies are examples of that phenomenon.

While describing the booming of popular cultures, it is essential to mention *Ayat-Ayat Cinta* as the most phenomenal Islamic movies. As mentioned before, this movie succeeded in gaining such amount of spectacular viewers, three million viewers in three weeks, when it was first premiered. This movie also reached to be watched by any class of Indonesian society, from early teenagers to older people, from the religious community to government officials, such as the President, the Vice President, cabinet ministers, ambassadors, and governors. The president mentioned that this movie is a reflection about Islam, especially on how to appreciate Islamic values more than just the symbol, so people can live in differences peacefully, whereas the Muslim community labeled this movie as a must-see movie.

Ayat-Ayat Cinta tells the love story of a man with four women. Based on the story, some people argue that this movie just the same as other love story movies. The only difference is on how this movie gave Islamic nuance as the content, for example, the Middle East background, the veil, the Arabic terms used, or the verses quoted from *Al-Qur'an* and *hadist*. Indonesian people used to equate Middle East culture with Islam. So, it is logical to regard *Ayat-Ayat Cinta* as Islamic movies offhand just because of its packaging.

The objection of the movie does not preclude the labeling of *Ayat-Ayat Cinta* as an Islamic movie. Islamic film becomes the new movie genre since the typical movies produced following the success of *Ayat-Ayat Cinta*. In addition to being a good description of the phenomenon of Islamic movies, it also becomes the appropriate film to represent how to be a good and pious man. Islamic masculinity depicts well in this movie.

Besides *Ayat-Ayat Cinta*, this paper also includes the analysis of another movie, which also labeled as an Islamic movie, titled *Tiga Do' a Tiga Cinta* (Three Prays, Three Hopes). The story of the three boys in the Islamic boarding school in the movie can portray the boy's life in an Islamic way. Several most favorite actors and actresses in Indonesia involved in the production of this movie and won Best Indonesian Feature in 11th Jakarta International Film Festival (JIFFest) 2009. It was also selected officially in various film festivals, such as Dubai International Film Festival 2008, Pusan International Film Festival 2009, Goteborg International Festival 2009, and Asian Pacific

Screen Award Australia. How the two movies represented Islamic masculinity is described as follows:

Ayat-ayat Cinta: questioning polygamy

Ayat-Ayat Cinta is adapted from a bestseller novel, authored by Habiburrahman El Shirazy, with the same title. The story of this movie based on the love story of a young handsome and intellectual Muslim, Fahri bin Abdullah Shiddiq, a student at Al-Azhar University, with four beautiful young women. First, Nurul, an Indonesian girl who also studies in Egypt and the daughter of a distinguished East Java religious leader. Second, Noura, an ungrateful Egyptian girl. Fahri saves her life, but she betrays him later by accusing him that he rapes her and then brings him to jail. Third, Maria, a Coptic Christian living next door to Fahri, who inexplicably converts to Islam at the end of the film. Fourth, Aisha, a girl from a wealthy German-Arab family. Finally, Fahri get married to Aisha after facing a lot of troubles, and also Maria (but, in the end, Maria passed away).

This movie focuses on polygamy as a controversial issue in Indonesia, as described in the previous section. The discourse of polygamy, according to Islam, is plural. Abdul Saeed, an Islamic scholar, categorized three approaches in interpreting the content of *Al-Qur'an* about polygamy in the modern context. The first category is the textualists who believe that Islam allows the practice of polygamy, referring to what Muhammad-the prophet-did. The second category is the semi-textualists; they think that polygamy is permitted on a certain condition, such as the actor treats his wives fairly. The third category is contextualists, who stated that Islam prohibits polygamy since polygamy only worked in *the Uhud* war. This war brought men died and caused women to become widows. Men who saved from the war should ask the widow to be his wives to support them (in Nurmila, 2009:43). Based on the third approach, it is impossible now for men to practice polygamy since they are in a different situation.

The different ideological background of Islam in Indonesia brings the issue of polygamy to become controversial. Nevertheless, the practice of polygamy in Indonesia indicates the exercise of men's power over women. The way men oppressed can be identified from the reason for that practice based on the profile of the polygamy award's winner. First, polygamy becomes the solution to regulate men's sexual desire legally since men have a strong sexual desire naturally. Second, men can take advantage of their wives to develop their business. Having more than one wife meant more people to help men running their works. Third, sharing the love for other women is worship. The actor of polygamy believes that the population of women is more significant than the population of men. Thus it is logical for women to share their husband with other women (Munti, 2005:135-139).

The practice of polygamy represents differently in *Ayat-Ayat Cinta*. The representation can be explained from these characteristics:

The practice of men's power

In this movie, men's power is in his personal/moral self-regulation. The term of self-regulation is borrowed from Pam Nilan et al. (2007) in her writing titled *Indonesian Muslim Masculinities in Australia*. Self-regulation refers to power over the self. Nilan et al. quoted from Errington, if western men usually associate power with physical/rational action, it means precisely the absence of sufficient power, according to men from Southeast Asia. According to Nilan's research, there is a contrast between hegemonic masculinity in Australia and Indonesia. In Australia, men used to exercise corporeal self-regulation, whereas in Indonesian men perform moral/personal self-regulation. Moral/personal self-regulation becomes the hegemonic masculinity in Indonesia rooted in the Javanese culture practiced during the new order regime represented by the figure of Suharto, as explained before.

Still quoting Nilan et al., their everyday behavior perform men with their moral/personal self-regulation. They also have self-control, which prioritizes reason more than passion (emotional self-restraint). Their power to control others comes from their inner strength, not from their physical strength or rude behavior.

The moral/personal self-regulation becomes the character of Fahri as the main actor of *Ayat-Ayat Cinta*. He is a kind, caring, and helpful person. He becomes a leader in a group of friends because of his personality. His personality also makes him popular among girls and to be a favorite figure for older people, such as his lecturers or his spiritual teacher.

Fahri obeys to perform his obligations as a Muslim, such as praying five times every day or reciting *Al-Qur'an*. He is also a tolerant person, respects others who have a different belief. In the relationship to the west, for example, he is not anti-west, so Fahri becomes a representation of a tolerant Muslim. It is a very different representation of Islamic masculinity performed by Islamic groups, which rejected everything from the west by using violence act. There is a scene in this movie that shows dialogue between Fahri and woman American journalist about Islam. Fahri explains to the women that Islam is a tolerant religion that loves peace. This dialogue encouraged the president of Indonesia after watching the movie to mention that *Ayat-Ayat Cinta* had successfully represented Islam as a peaceful religion.

The Relationship to Women

Fahri is also portrayed as a person who respected women. He often helps oppressed women. He protects Aisha that almost hit by a man who hates American since Aisha gives her seat to the American women in the metro. He also saves Noura from his stepfather's violent action and helps her to find her birth parents.

As a pious man, Fahri is just like ordinary people who feel and think about personal matters, including falling in love. When it comes to love, he becomes a man who is passive; he is not the only decision-maker and control holder. He shares the control and decision of a woman as his partner. He has deep feeling to Nurul, his close friend, but he does not have any brave to show his feeling. While he finally gets married to Aisha, he is not the one who has the initiative to do that. Aisha asks his uncle to propose Fahri to do what in Islamic tradition called *ta'aruf*⁶⁵.

This movie shows that women are not passive. They are smart and intelligent, wealthy, attractive, and bold. Nurul is the student at Al-Azhar University and described as a kind and achiever student. Maria, Fahri's neighborhood, although never mentioned as a well-educated woman, Fahri often admires her intelligence. Aisha, the same as Maria, never said as a well-educated person, but she is a woman who dares to express her opinion and convey her will and belief. After she gets married to Fahri, she often decides on the critical matter, such as the place to live, earned money since she is from a wealthy family, or even encourages Fahri to do polygamy.

The women empowerment representation in the movie indicates that men do not have full control over women. Fahri also has respect for women. It is performed in the way he never dares to stare at women's eyes or to touch them. Nevertheless, men still feels to be superior to women. In a marriage relationship, Fahri feels objected if Aisha controls him, pays the house they rent, buys him a new laptop, and takes him to the university by her car. Fahri tries to operate his power, but not roughly and rudely.

The Construction of Polygamy

This movie portrays a different representation of polygamy. Polygamy is not recommended practice for man precisely. It is often mentioned that if a man decide to do polygamy, treating his wives righteously is a must. Some people practicing polygamy are often considered religious figures. Religious excuses are used to justify it. This fact is often taken for granted by people that practicing polygamy is one of the images of pious men.

In *Ayat-Ayat Cinta*, the obligation to be fair in treating wives make the practice of polygamy is not easy. Fahri, as the actor of polygamy, never thought to practice polygamy, although he is portrayed as a pious man. If he then does it, it is not his will. Her first Wife, Aisha, forces him to marry another woman to save Fahri from jail for being accused of raping Noura; and also to save Maria, his second wife, who is seriously ill since she knows that Fahri gets married to Aisha.

In this movie, the choice to do polygamy is not under man's decision, but woman's. It is not relevant to Van Wichelen (2007) statement that polygamy is a form of male superiority. Rather than representing the man practicing polygamy as part of being religious and masculine, this movie as an Islamic movie precisely showed that polygamy is not the right choice for pious men since it generates problems. It is not easy to be fair to wives. In the end, monogamy is a happy ending.

3 doa 3 cinta: contrasting hipermasculinity

The movie narrates about three close friends: Huda, Rian, and Syahid, living in an Islamic boarding school. They have their own stories and problems. Huda wants to find his mother, who leaves him for years. He meets Dona, a sexy *dangdut* singer who helps him to find his mother. Rian obsesses with his camera, a gift from his mother on his birthday. After getting acquainted with Toha, a man who runs a traveling movie theater that is set up near the school, he plans to continue his father's business in video making. Syahid comes from a low-income family. He has negative feelings for Christians since real estate agents from America have cheated his father. It encourages him to join radical Islamic teaching and plans to do a suicide bombing.

People studying in Islamic boarding schools are called *santri*. *Santri* is regarded as being a devout Muslim. The representation of being devout Muslim men in this movie contrasts with being Muslim men portrayed by Islamic Youth Groups. Men from those groups often performs their religiosity by mentioning the name of God in their acts. For example, they call for *Allahu Akbar* (*Allah* is the Greatest) repeatedly while clenching their hand. Their acts' mission is to uphold Islamic norms they believed by using violence, destructive, and aggressive. It is not only attacked against gays and male-to-female transvestites but also assaults people holding different ideologies or destroyed buildings considered immoral. They hate people doing something they believed as sin and threaten Islamic norms and values.

In the movie, *santri* is not a saint or holy man. It is opposite to what Muslim men used to depict. Normatively, Muslim men describe as holy men who had a high level of morality. For example, he never has a close relationship with women, rejects homosexuality, prohibits enjoying an attractive performance, and hates western people. In the movie, conversely, Muslim men portrayed just like ordinary human beings who had a good and bad side.

Santri has to practice discipline. Living in an Islamic boarding school is strictly regulated under the rules. *Santri*, in the movie, is told as teenagers breaking the rules sometimes. They smoke cigarettes that are forbidden doing

⁶⁵ *Ta'aruf* is the right kind of dating in Islam. The main point is getting to know each other well before moving on to the next step (marriage). *Ta'aruf* is also about introducing each other to the traits of the family, understanding the hopes and dreams of one

another. Through this, they can decide whether they are match to one another or not.

this in the boarding school area; peep into the room of a girl; and go out at midnight secretly, which mean that they break the boarding school's rule. Huda, who become the best *santri* since he is chosen to be the future leader in the boarding school, also does those behaviors.

According to Islamic belief, if a man has a relationship with a woman, it is considered immoral. It is prohibited for Muslim men to touch a woman outside the family or marriage bond. In the movie, Huda has a close and intimate relationship with Dona, a sexy singer. He often spends his time enjoying the *Dangdut* show performing Dona with her tease dancing. There is also a kissing scene between Huda and Dona. This scene evidences that *santri* is not a saint; he just an ordinary man who sometimes follows his lust.

If the jihadist becomes the dominant portrayal of Muslim men constructed by the west, on the contrary, this movie represents that fundamentalism and radical Muslims as a threat to Islamic teaching. The Islamic teaching learned in the boarding school underlines this perspective by rejecting the radical view whose hatred to the west and their religion creates them as the enemy. Syahid plans to do suicide bombing as a jihad to attack American people. He is disappointed with the American real estate businessman who has bought their family land at a low price. But, in the end, he changes his mind after he realizes that not all American is terrible since the businessman has paid for the hospital cost of his father medical treatment.

One of the interesting themes of this movie is about the homosexual issue. Homosexuality becomes controversial issues in the religious context since the practice is regarded as a sin. According to Ibrahim Hewitt (1997:29), an Islamist speaker in his book *What Does Islam Say?*, Islam forbids homosexual practice, both sexual relations between two men or between two women. Since it is regarded as a great sin, the society under Islamic law will punish people conducting this practice severely. It is a radical view of homosexual practice, which is parallel to the belief of Islamic youth groups who attack homosexual.

There are some scenes in the movie, presenting the issue of homosexuality. The art teacher in the boarding school plays a role as a gay in the film. He often commits harassment with one of the *santri*. The movie does not try to exhibit its permissiveness to the homosexual act. It narrates that this act could be experienced by *santri* in boarding school as a religious place. The *santri* in the movies rejected the practice of homosexuality. According to the movie's story, the gay teacher is expelled from boarding school.

The issues in the movie mentioned points that the movie depicted humanized *santri*. It contrasts with the image of Muslim men portrayed by Islamic youth groups. While a member of Islamic youth groups shows their aggressiveness to fight immoral practices to perform their masculinity, *santri* in the movie, as a human being, can make mistakes sometimes.

Construction Of Muslim Men Within Islamism And Modernization In Indonesian Post New Order Era

Suharto's resignation as the president in 1998 has marked the fall of the authoritarian regime of the new order period and the rise of the new period of the reformation in the history of social and politic in Indonesia. The decentralization of power in the new period has encouraged the emergence of new groups to play their power in the social and political arena. The most influential groups are groups based on Islamic norms and values whose power provoked by globalization and modernization.

Vickers (2005:199) explained that since the running of the open market system in the middle of the 1980s, the flow of western culture enters in Indonesia currently. Globalization has blurred the border between nations. The media and communication technology advances facilitated the information flows. As a consequence, modernity and the progress of the nation refer to the west as the parameter. The significant influence of western modernity is blamed as the source of problems. Media liberalization dan industrialization as the gate of the entrance of western culture has caused moral panic among the Islamic groups. They assume that the process of westernization and secularization have threatened the Islamic values and cause moral degradation among youth, which estrange them from religion and tradition.

Based on these reasons, the Islamic political parties and organizations sue to the implementation of *sharia* law in Indonesia. They also attempt to make Islamic norms and values as guidance in the regulation-making. As the examples are the production of regional *sharia* regulations or the implementation of the Pornography Act driven by Islamic logic.

The media, as the product of modernity, has a survival agenda when there is the demand to return to the Islamic value. Then, the media should accommodate religious and modernity interests. It becomes the media strategy to negotiate their position between the clash of Islamism and modernization. Instead of treating it as a threat, the media takes this phenomenon as the advantage. The emergence of Islam as the new power encouraged the media to create the new niche potential market, considers as a religious marketplace. According to Wortham (2004), the religious market meets the producer and consumer in a religious context. This market is capable of pushing the competitive economic activity, or in another word, this can bring a promising profit to the producer, the media.

The production of Islamic movies is the success in creating a religious marketplace. For example, *Ayat-Ayat Cinta* has an achievement in bringing religious communities who never comes to the cinema before since they consider cinema as the secular domain. When the cinema screened Islamic movies, it blurs the border between the religious and secular domains. Watching Islamic films become part of religious rituals.

By negotiating religious and secular values, Islamic movies have reproduced the new meaning of religiosity, including in defining Muslim men. The representation of Muslim men in Islamic movies constitutes the form of negotiation of Islamic values and modernity. As a consequence, the construction of Muslim men cannot be separated from the symbol of modernity as the politic of representation. The symbols are explained as follow:

The Issue of gender equality

The feminist movement from the west is successful in developing the awareness of gender equality. This movement encourages the emergence of men's movement. While the feminist movements fight for the impartiality between gender, men's movements attempt to revise the discourse of traditional masculinity that put men's superiority and domination. Men's movements build awareness of the image of nurturer men as the ideal (Beynon, 2000). The nurturer men are the depiction of men with care to women, for example, by supporting women's career or willing to take women's roles defined by patriarchal cultures, such as taking care of the children and doing the domestic job. The nurturer men reject the image of macho men who often use violence to perform men's domination and superiority over women.

The image of nurturer men indicates men with affection to women. Fahri and Huda represented it as explained. The movies connect the piety with nurture in representing Muslim men. Gender representation in Islamic movies becomes a way to accommodate feminist and men's movement. Islamic movies represent the portraits of modern Muslim men.

The Issue of Human Right

The issue of terrorism and violence become a controversial global issue since it contrasted human rights. Consequently, Islamic movies never give an affirmative discourse on terrorism with its violent image. Both films mention the rejection of the practice of terrorism. Since the western perspective of Islam identified it with terrorism, Islamic movies attempted to give another image of Islam. Islam in Islamic movies is the portrait of modern Islam, which supported the values of human rights. Modern Islam is Islam with peace, tolerance, and humanized.

Another theme related to the human rights issue is homosexual. Islamic movies have a different position with the Islamic youth groups in rejecting the practice of homosexual since the film does not give excessive stigma to the homosexual issue. The rejection of homosexuals in the movie becomes more human compared to the Islamic groups' violent acts.

The Representation of West

Modernization is the concept that came from the west. To be modern often includes the west or American images. The radical or fundamentalist Islamic groups often consider the

west and America as their enemies since America and its allies fought against Islam in their attack in Iraq, Afghanistan, and other Islamic states.

In Islamic movies, the west and Americans are never mentioned as the enemy or even in negative representation. Although the west and America do not represent religiosity and virtues, they are never performed as "bad guys." West and America become the symbol of modernity. Modernity is the progressive way, and to be modern is important.

The Display of Modern and Global Products

Islamic movies are not different from James Bond's movies or other Hollywood movies. They display the global brands and products represented as a symbol of modernity. In the film, brands like *Apple*, *Nokia*, *Sony*, or *Mercedes* showed blatantly. It is a relevant image of Islam that already mentioned: modern Islam. Modernity becomes an essential aspect of Islam. More presently, it can be stated that Islamic movies attempt to represent modern Islam. Modern Islam becomes the form of compromise between Islamism and modernity.

The negotiation of religious and secular values that forms the Muslim identity cannot be separated from the effort to build the identity of "modern Islam" or "modern but Islamic." This contradictive combination between Islam and modernity is supported by the characteristics of the Muslim market in Indonesia, as explained by Yuswohady (2014), as Muslims who are open and permissive to global culture. This statement is parallel to Pam Nilan's (2006) research of devout Muslim youth culture. Nilan stated that devout Muslim youth identifies themselves as modern Muslim youth. They regulate Islamic religious values in everyday life and used western and modernity symbols, such as wearing jeans or consuming the product of technology, at the same time. Nilan also mentioned that Muslim youth culture portrays the elements of religiosity and the trends of global popular culture by creating products and hybrid practices to secure young people from the attack of orthodox Islamic values and popular globalization cultures (2006:107). Linla Abu-Lughod (in Van Wichelen, 2007:101) called it as alternative modernity. The new form of modernity is presented by the middle-class Muslim who chose to be modern by doing Islamic practices.

Conclusion

Indonesian Islamic cinema becomes a site for constituting Muslim identity and promoting Islamic practices and values. In the two movies analyzed in this article, the Muslim identity refers to the identity of being devout Muslim men. Being devout Muslim men is performed by their self-regulation, relationship to women, and open-minded to global influences. Men with self-regulation have a meaning of men whose attitude and behavior controlled by their rationality. Men's self-regulation leads men to have respect and care for women. Their thoughtfulness performs the men's power to women. Muslim men are also portrayed

as figures that respected other people and tolerated to different values and beliefs.

The construction of Muslim men in Islamic movie is the middle way to accommodate Islamism and modernization during the post new order. Muslim identity relates to the identity of "modern Islam" or "modern but Islamic."

Images of men worked as the symbolic representation of the current process of Islamization and the rise of consumer culture. This representation is never final, but always being negotiated to meet the market forces and Islamic values.

Reference

- Bayat, Asef. (2003). The Use and Abuse of 'Muslim Societies.' *International Institute for The Study Of Islam in the Modern World Newsletter*, 13, Accessed on 14 March 2015 from www.isis.nl/files/News1_13.pdf
- Beynon, John. (2002). *Masculinities and Culture*, Buckingham and Philadelphia: Open University Press
- Boellstorff, Tom. (2004). The Emergence of Political Homophobia in Indonesia: Masculinity and National Belonging, *Ethnos*, 69(4)
- Brittan, Arthur. (1989). *Masculinities and Power*, UK dan USA: Basil Blackwell
- Collins, Elizabeth Fuller. (2007). *Indonesia Betrayed: How Development Fails*, Honolulu: University of Hawaii Press
- Connell, R. W. (2000). *The Men and The Boys*, Berkeley and Los Angeles, California: University of California Press
- _____. (2005). *Masculinities*, Berkeley and Los Angeles, California: University of California Press
- Clark, Marshall. (2004). Men, Masculinities, and Symbolic Violence in Recent Indonesian Cinema, *Journal of Southeast Asian Studies*, 35(1)
- Frey, L., Botan, C., and Kreps, G. (1999). *Investigating Communication: An Introduction To Research Methods*, Boston: Allyn & Bacon
- Gerami, Shahin. (2005). Islamist Masculinity and Muslim Masculinities. In Kimmel, Michael, Hearn, Jeff, Connell, RW. *Handbook of Studies On Men and Masculinities* (p.448-456). California: Sage Publication
- Handajani, Suzie. (2005). *Globalizing Local Girls: The Representation of Adolescents in Indonesian Female Teen Magazines*, MA Thesis, The University of Western Australia
- Heryanto, Ariel. (2014). *Identity and Pleasure: The Politics of Indonesian Screen Culture*, Singapore and Kyoto: NUS Press and Kyoto University Press
- Hewitt, Ibrahim. (1997). *What Does Islam Say?*, UK: Muslim Educational Trust
- Kimmel, Michael S. (2005). *Gender of Desire: Essays On Male Sexuality*, Albany: State University of New York Press
- Munti, Ratna Batara. (2005). *Demokrasi Keintiman: Seksualitas di Era*, Yogyakarta: LKIS
- Nilan, Pam. (2006). The Reflexive Youth Culture of Devout Muslim Youth in Indonesia. In Nilan, P. & Feixa, C. *Global Youth? Hybrid Identity, Plural Worlds* (p.91-110). New York: Routledge
- _____. (2007). Indonesian Muslim Masculinities in Australia, *Asian Social Science*, 3(9)
- _____. (2009). Contemporary Masculinities and Young Men in Indonesia, *Indonesia and Malay World*, 37(109)
- Nurmila, Nina. (2009). *Women, Islam and Everyday Life: Renegotiating Polygamy in Indonesia*, New York: Routledge
- Ouzgane, Lahoucine. (2006). Islamic Masculinity: An Introduction. In Ouzgane, Lahoucine *Islamic Masculinity* (p.1-8). London and New York: Zed Book
- Pye, Lucian W. dan Mary W. Pye. (1985). *Asian Power and Politics: Cultural Dimensions of Authority*, New Haven: Yale University Press
- Reesser, Todd W. (2010). *Masculinity in Theory: An Introduction*, UK dan USA: Willey-Blackwell
- Said, Edward W. (1997). *Covering Islam: How The Media and the Experts Determine How We See The Rest of the World*. USA: Vintage Books
- Tiger, Lionel. (2005). *Men in Groups*, New Jersey: Transaction Publishers
- Van Wichelen, Sonja. (2007). Reconstructing 'Muslimnes': New Bodies in Urban Indonesia. In Cara Aitchison, Peter Hopkins, dan Mei-Po Kwan, *Geographies of Muslim Identities: Diaspora, Gender, and Belonging* (p.93-108), England: Ashgate
- Vickers, Adrian. (2005). *A History of Modern Indonesia*. Cambridge: Cambridge University Press
- Widodo, Amrih. (2008). Writing for God: Piety and Consumption in Popular Islam. *Inside Indonesia*, Accessed 13 May 2015 from <http://insideindonesia.org/content/view/1121/29/>
- Wortham, Robert A. (2004). Religious Choices and Preferences: North Carolina's Baskin Robbins Effect?. Sociation Today. 2(1). Accessed 13 May 2015 from <http://www.ncsociology.org/sociationtoday/v21/religion.htm>
- Yuswohady. (2014). Empat Sosok Konsumen Muslim. Accessed 15 Juni 2015 from <http://www.yuswohady.com/2014/06/14/empat-sosok-konsumen-muslim/>

Political Identity of Ganjar Pranowo and Taj Yasin Maimun Candidate Pair in the 2018 Central Java Election Contest

Muhamad Nastain

Universitas Mercu Buana Yogyakarta, Indonesia, nastain@mercubuana-yogya.ac.id

Abstract - Political developments in the history range write that the contestation of political battles always involves public participation as a determinant of victory. Public participation in political spaces after the reformation shows an increase as evidenced by the growth of new political parties. The increasing growth of political parties is certainly linear with the involvement of the public. The level of public participation is ideally balanced with good political education by stakeholders. This needs to be discussed and become a systematic and measurable program by the government and political parties to provide political education. Thus, the community is not only involved as a voter but also understands the consequences of their political attitude. Identity politics was implemented by the Central Java gubernatorial pair Ganjar Pranowo and Taj Yasin Maimun. Consideration of segmentation and positioning in the political marketing of 2018 Central Java regional election of incumbents are inseparable from the characteristics of community groups. Consequently, raising a question how the Social Political Phenomenon of Identity of Candidate Pairs Ganjar Pranowo and Taj Yasin Maimun in the Local Political Stage of the Central Java Election 2018?. This study uses qualitative research methods through the phenomenological approach of Berger and Luckmann. The theory and social construction approach to reality occur simultaneously through three social processes, namely (1) externalization (self-adjustment) with the sociocultural world as human products, (2) objectivation, that is social interactions occur in the intersubjective world which are institutionalized or in the process of institutionalization and (3) internalization, that is the process by which individuals identify themselves with social institutions or social organizations where the individuals are members.

Keywords: Politics, identity, local election, Central Java, political contestation

Introduction

The discussion of authority and politic always trigger everyone's critical logic. From the ancient Greece philosophers, Socrates until the enlighten era by Thomas Hobbes completed by John Locke and Montesquiu with the *trias politica* theory (Budiarjo, 2014 : 14-15). The political development history written that the political war always involves the public participant as a triumph determinant.

Public participation in political spaces after the reformation shows an increase as evidenced by the growth of new political parties. The increasing growth of political parties is certainly linear with public involvement. The requirements set by the Law require public involvement by making management up to the branch level. According to Herbert McClosky, a figure on the issue of participation said that political participation is voluntary activities of citizens of the community through which they take part in the

process of selecting the authorities and directly or indirectly in the process of forming public policies (*The term political participation will refer to those voluntary activities by which members of a society share in the selection of rulers and, directly or indirectly, in the formation of public policy*)(Mc Closky, 1972 : 252).

Public participation in politic is an inevitability. According to Firmanzah in Political Marketing mentioned that the characteristic of politic is the first, political world has a society that direct-indirectly involved. Directly involved means that the society directly plays a role and faced the impact from all the political activity. While indirectly involved means the society got affected but not directly playing a role in painting the political policy and activity. The second, political world has a legal institution inside. The third, political world has a legal playing role and ethic that arrange the political actor ways inside (Firmanzah, 2012 : 3-4).

The level of participation public should be balanced with a good political education by the stakeholder. This needs to be discussed and be a systematic and measureable program by the government and politic party to give political education. Thus, the society is not only involved as an elector but also understand the consequences from his/her political attitude. Without a good political education, this will produce a sidetrack political practice. Today, this is massive to look at the Machiavelisme practice that makes the power as a great goal by betraying the process. This still becomes a debate whether the political identity practice by sticking out their self-identity (decedents) by ignoring the competence is a sidetrack political practice.

Identity politic implemented by Central Java governor candidate Ganjar Pranowo and Taj Yasin Maimun. Segmentation and positioning consideration in political marketing of 2018 Central Java election defensive is not standing alone by the society characteristic. According to the field observation, the step done by the candidate's politic party attempt to get the constituent vote with the religious class of people with the stimuli of a great name of Islamic scholar KH. Maimun Zubair. While Ganjar considered as a nationalist and "abangan".

The division of religious nationalist politic area or "abangan" and Moslem students becomes a special political strategy in Indonesia. Ganjar Yasin is not the first one who implemented this strategy. The former is Wiranto Wahid in 2019 President's election. Even then appear a 2019 president's election contesting will bring out the same

strategy by making Muhaimin Iskandar as a defense vice president candidate.

Both segmentation and positioning are two things that cannot be separated. Segmentation used to chart and identify the society characteristic while positioning used to put the image of politic product that is identity or the family name. In measurable portion identity politic product become a solution in perpetuating the authority hegemony. However, if this is not supervised and there is no a strict regulation, this will cause an oligarchy politic. In the end authority will be only enjoyed by some people with their great family name and a strong financial. Political liberty as one of individual freedom form can be bothered because the contests do not give them a fair chance to win the politic war.

Through the politic culture discussed above so that authority will only be a certain people or group. Public forced to accept because indeed there is no choice and power to oppose. Even it become worrisome as Antonio Gramsci said that the supervisor come and go but the public still in the same position. This means that the authority alternation have no effect at all in the public prosperity increasement. The politic party network and authority hegemony will be an research focuss that in the end will give a political education to the public and raise the political awareness. Leave the above facts and data, this research pointed in a research question: **How Social Fenomena Identity Politic from the Couple Candidate of Ganjar Pranowo and Taj Yasin Maimun in the Politic Performance in the Governor Election in Central Java 2018?**

Literature Review

There are some former researches related to political of identity that will be able to add and widen this problem in that governor election in Central Java.

According to Aris Munandar and Idris Hermay (2016), this research will get the comprehensive illustration about the influence of imaging and identity from the Bengkulu's governor election candidates in 2015 towards the voters' behavior. This research uses two aspects that are politic behaviors, ethnicity identity behaviors, and the candidate's image in the politic sociology perspectives. Through the survey method, get the result that ethnicity identity, image and figure factors are positively contribute in the formation of voters' behaviors in the Bengkulu's governor election.

The contest of public election always seizes the attention, opinion and energy. This process makes the elites politic party that will be public election participants will sustain to make a campaign. With different background of 2014 public election system, especially in legislative candidate election mechanism, Edwi and Wibowo (2015) research will pay a close attention from the campaign activity in the blog and web. 2014 public election used the most voters system in determining the legislative candidate. Through the qualitative approach, conclude that the legislative candidates of 2014 public election use the political of identity in the use of party symbols such as the party's color identity, party figure and the party attribute.

The use of party figure is as legislative candidate endorser in raising their image while the attribute color to emphasize their party's origin.

2.2. Identity Politic in the Politics' Communication

Politics' communication starts from the study about the mass media effect towards the individual vote. But today, this field has been widen include other communication aspects and politic behaviors. Having politics however will always be in tense wars that chop with the identity. Identity explained as a blood realm and descendant. In other perspective, it placed in the ethnic group and geographies. While others, focusing in the ideology and religious area. Political of identity is a starting point in together lives managing, that through this a group make a certain identity construction (Riyanto, 2015: 123).

In the politics' communication process, it is firm related with image that means as an organization member's way in looking the impression, image and attributes that sticking in a certain entity. So that forms a party perception or individual contestant (Firmanzah, 2012: 229). Besides that, political of identity is sharply differentiated between political identity with political of identity (Haboddin, dalam Sosiawan & Rudi, 2015). Political identity is a construction that determines the subject importance position in a politic community alliance while political of identity aim at the mechanism of organizing politic identity (both identity and social identity) as a politic source and means.

Political of identity has a freedom importance from the frontier situation that specifically concern in the constituency from the membership in a wider context. Identity politics seems to confirm the existence of essential wholeness about the existence of certain social groups based on identification of primordiality. According to Manuel Castells, identity construction use material structure from the history, geography, biology, production and institution reproduction, collective memory and individual fantasy, authority apparatus, and religious ideology. Something can be mentioned as an identity if it is internalized by the outer society. Castells mentioned that there are three categories in this collective identity (Munandar & Idris, 2016 : Salim, 2015) :

- a. Legitimizing identity; identity that introduced by an institution that dominate the society to rationalized and continue their domination towards the social actor such as a country institution that try to increase their society nationality membership. This institution surely has received the legitimacy to do it.
- b. Resistance identity; is a process to form an identity that maintained by resisting. A way should be gone is through the stigma from dominative side. This formation aim to their membership and group live continuity. It caused as a terminology when Calhoun identified the appearance of certain politic of identity.
- c. Project identity; in identity when the social actor form a new identity that will be able to determine new portions also transformed the social structure totally. Such as, when a feminism activist group try to form new female identity. Things should be done is re-associate the female position in the society, both

production right, reproduction and sexuality, politic and personalization.

Research Paradigm

This research used post positivistic paradigm because it is based on the post positivism philosophy. It is also referred to constructive paradigm that means look at the social reality as a holistic, complex, dynamic, meaning able thing and a reciprocal relation (Sugiyono, 2007).

In this paradigm the relation of researcher and research object has an interactive characteristic. That is why there should be neutrality from the researcher to minimize the subjectivity. The researcher directly involved in digging the data, discussing with the informant until analyzing the data.

This research will also apply inductive mind mapping that is thinking method that based on empiric facts towards the general. It will include: observation, data collection, data analysis, and drawing conclusion process (Kriyantono, 2007).

Research Method

This study uses qualitative research methods with a phenomenological approach, which aims to explain phenomena that occur in social reality with the support of valid data. The qualitative approach begins with observing the symptoms and then observing in depth and supported by library records. The phenomenology method in Berger's approach intends to combine holistic and individualistic analyzes in social reality.

Phenomenology is an idealism that interested in the structure and the working ways of human's awareness that implicitly believe that our world created as a basic awareness. Phenomenology interested in the problems' identification from the sense experience world that means at the world full of meaningful objects, something that happened at first in the separated individual awareness, and then collectively in that awareness interaction.

Berger and Luckmann believe substantively that reality is the result of a creative human's creation through the social constructive power toward the social world surrounding, reality is social constructed. Social constructive theory and approach of reality happens simultaneously through three social processes, that is (1) externalization (self-adaptation) with the socio cultural world as the human's product, (2) objectivities, that is social interaction that happens in inter subjective world that organized or experience the institutionalization process and (3) internalization, that is process which is individual identified themselves in the social institutions or social organization individual place they become the member (Bungin, 2008 : 193). The point is that social construction is knowledge formation that gained from social invention. Reality has a meaning when the social reality constructed and explained subjectively by other people so that firm up that reality objectively.

Discussion

Political conversation cannot be separated from the discussion about seizing and maintaining power,

distributing power and talking about authority. The contestation of the five-year election talked a lot in the first point, namely the question of seizing power by the opposition and maintaining power by incumbents. The political event is a venue for fighting ideas and concepts like a classic battle. If the battlefield in ancient times was a vast field where two large forces met with strategy spices and all deceit, today's political battles have more diverse combat space with various public spaces.

Identity politics or often referred to as sectarian politics, according to Dedi Kurnia Shah, observers of national politics, are a perspective on political references based on similarities where identity similarity is a reference. The identity referred to cultural based, such as religion, organization, primordial and others. The implementation of the identity politics strategy was felt in the 2018 Central Java regional election, which one of the contestants was the son of Mbah Maimun Zubair, Charismatic Islamic scholars from Pesantren Al Anwar Sarang, Rembang.

The combination of nationalist figures, represented by Ganjar Pranowo, and religious leaders, represented by Gus Yasin, became the couple who did not fulfill the public expectations. Religious nationalists are becoming very selling identities when many pendulums of state political issues are dominated by issues concerning violence in the name of religion, ethnicity and race. Castells suggests that there are three categories of this collective identity (Munandar & Idris, 2016: Salim, 2015):

1. Legitimate identity (legitimizing identity)

Epistemologically, legitimizing identity is an institution dominates a society to rationalize and continue its dominance of social actors. Religious nationalist identity is a concept constructed by a team of Ganjar-Yasin couples, where the public, as voters, are given the ideal option in the face of recent political fluctuations. The choice of identity is not without mature political calculations but based on the reality of the Central Javanese community which is dominated by nationalists and santri. Central Java has long been known as a voice barn of PDIP even specifically referred to as a nationalist kitchen or also known as a bull cage (PDIP Community).

Based on the voter configuration approach, this is known that there are effective community groups if this is stimulated by the issue of sectarians, religious and primordial similarities. Based on the configuration, traditional voters have the highest orientation towards identity closeness. In fact, they tend to ignore other substantial factors that should be a benchmark of choice. Competence and ability to solve problems are not taken seriously.

Political demagoguery uses rhetorical abilities to deceive society by promoting public interest as masks and one hand hiding individual and group agendas that actually dominate. Demagogues and identity politics are a neat blend in tricking traditional voters. The production of hatred discourse and black propaganda is often an instrument that strengthens the political style above. People with low levels of education will take the discourse haphazardly and tend to trust, especially those who convey are figures.

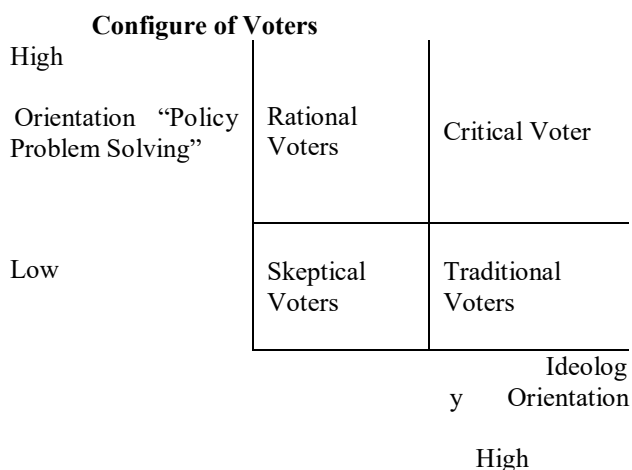

Picture 1: Configure of Voters

Rational and critical voters are less exposed to the practice of identity politics. The reasoning and cognitive abilities of the two types of voters deliver to a choice based on problem solving skills and competency of prospective leaders. Although, in ideological closeness between them, there are also differences, the rational voters tend not to have ideological proximity factors. They give a pure assessment of the candidate's abilities and put forward expectations as a reference. While critical voters have high ideological ties so that they combine the consideration of candidates' abilities and ideology.

2. Resistance identity

Resistance identity is interpreted as an identity formation process maintained by resistance. One of taken methods is through the stigma of dominating parties. When the pair Ganjar and Yasin built a nationalist and religious identity on the basis of the cultural character of using Islamic boarding schools and millennial santri instruments, the competitor candidates, Sudirman Said and Ida, built their identity as technocrats and female leaders. Even if this is drawn further, actually, the identity built has the same level of similarity as the religious nationalists by the experience of the Organization at the Banom NU Muslimat at the central level.

The rise of sectarian politics or specifically Islamic religious identity politics is based on the development of political issues since the 2014 presidential election. Judging from the long history of Indonesian politics, the founders of the Nation have also debated related to religious issues, so that we recognize the Pancasila charter as one of the elements history. The 2014 presidential election was thick with narration and propaganda related to religion and ideology. "Obor Rakyat" Magazine as a propaganda media discredited one of the candidate pairs with an extraordinary narrative of hatred, even though today there was a pro-contra related to its existence. Many parties consider the "Obor Rakyat" Magazine to be a "playing victim" strategy for candidate pairs, but many people believe that it is black propaganda to bring down opponents.

Sectarian narratives in the name of religion are the most perfect political commodities today. Under the pretext of struggle in the name of religion or *jihad*, people can be

mobilized to contribute time, energy and costs. This is not surprising that the identity or sectarian political strategy is the most rational choice in the 2018 Central Java regional election. Religious-nationalist identity will not get resistance from any party. The Nationalists feel represented by the presence of Ganjar Pranowo, who incidentally is a PDIP national politician, as well as religious people represented by Gus Taj Yasin Maimun.

The determination of the identity political strategy begins with determining the candidate pair which is a religious-nationalist representation. According to information circulating, before nominating Gus Yasin to become a candidate for deputy governor accompanied Ganjar Pranowo, the name Gus Yusuf Chudhori the leader of pesantren API Tegalrejo Magelang was first raised. However, he refused to accompany Ganjar Pranowo, because he did not get permission from his mother. The next option is Gus Yasin Maimun, besides being a politician who has experience as a member of the Central Java Provincial Parliament, he has also a santri background so that it precisely represents a religious identity.

Based on Berger and Luckmann's phenomenology approach, reality is the result of creative human creation through the power of social construction to the social world around it. Identity constructed becomes an reality in society through an external process. This process works by adjusting to sociocultural as a human product. The community made adjustments related to the information and production of the religious-nationalist identity discourse of the candidate pair Ganjar Yasin.

3. Project Identity

Project Identity is an identity when social actors form a new identity that can determine new portions while transforming the structure of the society as a whole. For example, when a group of feminist activists tried to form a new identity for women, the things to do is to re-associate the position of women in society, both those related to production rights, reproduction and quality, personality and politics. The same thing was done by the candidate pair Ganjar Yasin where they reproduced their original identity and associated with a new identity. Although reproduction is not frontal, this is done because their initial identity is already referring there.

Reproduction and Identity Association

The affirmation of identity is strengthened by the production of information through campaign props and political information from various media channels. The association among personal, santri and pesantren is very close to the figure of Taj Yasin that he even covers the portfolio as a member of the Provincial DPRD. The character of the charismatic cleric Maimun Zubair also cannot be released as the main strong contribution of the building of the religious identity. Even people tend to know Mbah Maimun more than Taj Yasin.

Association strategies are effective used to influence public opinion. Central Javanese people with pesantren backgrounds or Nadhliyin (NU People) find their political estuaries. Taj Yasin gave a lot of hope for the birth of an Islamic leader born of santri. This was like finding an

oasis from the long journey of the fate of the "sarungan people" who were always marginalized. While the nationalists got the certainty of the ideology of the association between the figure of Ganjar and PDIP and the ideology of Marhaen Soekarno. Both display identity and associations that are reproduced in accordance with the interests of regional elections without betraying their real identity. This can be said that reproduction of identity is done according to the original character without extreme changes. This facilitates people's acceptance of reproduction of the identity.

Personality

The Project Identity is carried out by paying attention to the construction of new identities with personality. Conformity among message, identity and personality will confirm the building of new identity. Almost on every occasion, Taj Yasin was never separated from the black cap attached to his head. Black cap is not just a head covering, semantically, this can be associated with *nahdliyin* and *pesantren* who are the bassists of religious masses. In addition to black caps, the consistency of using a sarong in various events shows a clear background from where it came from. The packets that represent religiousness must always be highlighted to further emphasize the religious identity and *santri* that are the strength of Taj Yasin.

Contrary to Taj Yasin, different things are displayed by Ganjar Pranowo. In line with the construction of nationalist identity, almost in every event, he is rarely seen using religious attributes such as *peci* or *sarong*. Ganjar is consistent with a nationalist look wrapped in a shirt or batik paired with trousers and even tends to be casual. In gesture, He is even more relaxed and communicative, especially when responding to netizen questions on social media. Even Ganjar is included in the ranks of communicative officials in interacting through social media.

Conclusion

Identity politics was implemented by the Central Java governor candidate of pair Ganjar Pranowo and Taj Yasin Maimun. Consideration of segmentation and positioning in the political marketing of 2018 Central Java regional election of incumbents is inseparable from the characteristics of community groups dominated by religious and nationalist circles. Religious people with the basis of *pesantren* or *sarungan* people are represented by the taj Yasin figure, while the nationalists are represented by the figure of Ganjar Pranowo as a senior PDIP politician.

Identity politics can be done in three approaches, namely legitimizing identity, resistant identity, project identity through reproductive instruments and associations of identity and personality. The strategy promoted by Ganjar Yasin proved to be effective in delivering them to become the pair of Governor and Vice Governor of Central Java 2019-2024 defeating Sudirman Said who was paired with Ida Fauziah.

References

Books

- Budiarjo, Miriam. 2014. *Dasar-Dasar Ilmu Politik*. Gramedia Pustaka. Jakarta
- Bungin, Burhan, 2008, *Konstruksi Sosial Media Massa*. Kencana. Jakarta
- Firmanzah. 2012. *Marketing Politik : Antara Pemahaman dan Realitas*. Yayasan Pustaka Obor. Jakarta
- Herbert, McClosky. 1972. *Political Participation, International Encyclopedia of the Social Sciences*. Second Ed. The Macmillan Company. New York
- Kriyantono. 2010. *Teknis Praktis Riset Komunikasi, Disertai Contoh Praktis Riset Media, Public Relations, Advertising, Komunikasi Organisasi, Komunikasi Pemasaran*. Kencana Prenada Media Group. Jakarta.
- Moleong, L. 2013. *Metodologi Penelitian Kualitatif, Paradigma Baru Ilmu Komunikasi dan Ilmu Sosial Lainnya*. PT. Remaja Rosdakarya. Bandung.
- Pawito. 2008. *Penelitian Komunikasi Kualitatif*. LKiS. Yogyakarta
- Riyanto, Armada. 2015. *Berfilisafat Politik*. Kanisius. Yogyakarta
- Sugiyono. 2007. *Metode Penelitian Kuantitatif, Kualitatif dan R&D*. Alfabeta. Bandung

Journal

- Munandar, Aris dan Hemay, Idris. 2016. *Politik Identitas dan Pencitraan Kandidat Gubernur Terhadap Perilaku Pemilih*. Jurnal Kajian Politik & Masalah Pembangunan, Volume 12, Nomor 1, 2016. hal. 1737 - 1748 <http://journal.unas.ac.id/politik/article/view/163> (diakses 2 Maret 2018)
- Salim, Komarudin. 2015. *Politik Identitas di Maluku Utara*. Jurnal Kajian Politik & Masalah Pembangunan, Volume 11, Nomor 2, 2015. hal. 1667 - 1678 <http://journal.unas.ac.id/politik/article/view/155> (diakses 2 Maret 2018)
- Sosiawan, Edwi dan Wibowo, Rudi. 2015. *Representasi Politik Identitas dalam Kampanye Online Caleg Parpol Peserta Pemilu 2014*. Jurnal Ilmu Komunikasi, Volume 13, Nomor 3. Hal. 234-298 <https://media.neliti.com/media/publications/100060-ID-representasi-politik-identitas-dalam-kam.pdf> (diakses 2 Maret 2018)

Research Report

- Suryani dan Azmy, Ana. 2016. *Politik Identitas dan Nasionalisme Kebangsaan (Studi Atas Penguatan Politik Identitas Etnis Tionghoa di Indonesia Pasca Orde Baru)*. Laporan hasil Penelitian Ilmu Pengetahuan. Pusat penelitian Penerbitan UIN Syarif Hidayatullah. Jakarta. http://repository.uinjkt.ac.id/dspace/bitstream/123456789/34074/1/suryani%20Ana%20S_%20lap%20penelitian%20pengembangan%20ilmu%20pengetahuan%20POLITIK%20IDENTITAS%20DAN%20NASIONALISME%20KEBANGSAAN.pdf (diakses 2 Maret 2018)

Development of Social-Emotional Learning for Generation Alpha in Islamic Education Perspective

Anisa Dwi Makrufi
Faculty of Islamic Studies
Universitas Muhammadiyah Yogyakarta
 Yogyakarta, Indonesia
 Email: anisadwimakrufi@fai.umy.ac.id

Made Dike Julianitakasih Ilyasa
Faculty of Islamic Studies
Universitas Muhammadiyah Yogyakarta
 Yogyakarta, Indonesia
 Email : made.dike.fai17@mail.umy.ac.id

Abstract—The development of the era requires humans to be able to answer various challenges of existing problems. The era of digitalization, as we call it as the Industrial Revolution 4.0, changed all forms of human life. It cannot be denied, the digitalization era has helped change the current educational order, including Islamic Education (IE). As the era progressed towards digitalization, moral degradation was increasingly prevalent. One effort to overcome moral degradation in the school environment is by implementing Social-Emotional Learning (SEL). The generation of Alpha (Gen-A) that will fill educational institutions at the Primary School level for the next few years will be the main focus of this paper's discussion. It is a challenge for educational institutions, parents, and teachers on how to implement SEL in a concrete manner in the classroom learning consisting of Gen-A students, especially in Islamic Education (IE) subjects. The research method used library research. From the result of this study, we found that the development model of SEL in the learning process in schools is actually a reflection material for educators to be able to enlighten the paradigm of thinking about intelligence or skills. However, some renewal is needed for the SEL approach related to Gen-A's learning style.

Keywords— *Social-Emotional Learning, Generation Alpha, Islamic Education.*

I. INTRODUCTION

The name of Generation Alpha may not be familiar enough to the millennial generation or generation Z. For Generation Alpha education practitioners, Generation Alpha becomes a topic that is warm enough to be discussed. This generation was born after generation Z, will swell its population to 2 billion by 2025. They will be the most prosperous, most educated generation because of more school opportunities in the present era and easy access to information technology. Alpha will be a generation that relies heavily on technology beyond millennial and Gen Z.

The birth phenomena of Generation Alpha certainly carry challenges for parents and educators in schools especially, in the educating practice of character values, particularly the social emotional domain. Recent research explains the fact that students who develop social and emotional competencies will lead healthier lives and better performance in school (Greenberg, et al., 2003). Therefore, educators and governments, especially ministries of education throughout the world, promote learning that emphasizes the social and emotional skills (SEL) [12].

The development of technology and information is considered to be an inseparable part of people's lives. In

fact, it can be said that tools with sophisticated technology have become a central part of their lives. Furthermore, nowadays, many people, especially the younger generation, rely on things that are instantaneous, so real time is the main prerequisite for this generation. Not without problems, if this is continuously allowed, what will happen is that many young generations are ignorant of social life. In fact, this will tend to shape the character of children who do not like direct verbal communication to be individualistic and egocentric; willing to have instant results, are all easy, and cannot appreciate the process. Basically, the development of digital technology allows changes at several levels, such as: 1) Individual levels, 2) Social interactions, and 3) Community levels [24].

Social and emotional learning (SEL) is a promising approach to increase the success of students in the school and life (Elias, et al. 2006). Research shows that mastery of social-emotional competence is related to better school welfare and performance, while failure to achieve competency in this field can lead to various personal, social and academic barriers (Eisenberg, 2006).

Recent research explains the fact that students who develop social and emotional competencies will lead healthier lives and better performance in school (Greenberg, et al., 2003). Therefore, educators and governments especially the ministries of education throughout the world promote learning that emphasizes on social and emotional skills (SEL) [12].

Starting from that, research related to the development of social and emotional learning is considered important as an effort to develop the character of the nation's generation that has developed due to the heterogeneity and openness of mind on knowledge and technology in comprehensive education.

II. METHOD

The method used in this research is a library research with content analysis followed by descriptive-analytic [8]. Library research is a research method through examining the data sources consisting of literature relating to a particular theme [15]. In this paper, we examine the data sources about Generation Alpha and the development of SEL in the perspective of Islamic Education. Content analysis is an objective, systematic research technique and quantitative description of real communication content [2].

Content analysis is a research tool used to determine the existence of certain words, themes, or concepts in some qualitative data [30]. With content analysis, researchers can measure and analyze the existence, meaning, and relationship between certain words, themes, or concepts. Then, researchers can draw conclusions on the messages in the text, authors, audience, even culture and time from around the text. Meanwhile, descriptive analysis is a fundamental component in a study because of its role in observing the world or phenomena, then, identifying research questions and generating hypotheses based on what has been studied [31]. This study uses an approach from the psychological pedagogy perspective. Psychological pedagogy perspective is an analytical method and static object introspection—on the contrary, which gives ideas and actions that aim to find the essence of ideas to be poured into all actions [10].

III. RESULTS AND DISCUSSION

Social emotional competence is mindset, knowledge, skills and attitudes are needed to support human success in their lives. This competency contributes to the learning process of schools and governments implementing practices and policies that enable children and adults to apply these competencies effectively. According to Dewi, SEL is an approach that encourages students to improve knowledge, constructive social relationships, positive behaviors, and skills that support learning [11]. SEL skills include empathy, preventing violence or intimidation, communication skills, and managing emotions [14]. In general, social emotional competence in daily life can be developed through: *first*, environment that support the learning process, *second*, good communication between adults and peers, *third*, instructions for explicit emotional social learning, and *fourth*, integration of social emotional learning on academic instruction.

Important capabilities in EQ (Emotional Quotient) delay gratification and bounce ability [33]. Providing the first ability is by holding back or delay things so that the results are more productive. Second, bounce ability, this ability is related to how we do not give up easily and are able to rise from unpleasant conditions. The way to practice the ability of EQ is the individual must allow people to be in a period that can suppress the person. However, stress conditions must be balanced and not excessive.

The next important skill is a social skill that is the ability to make people aware and influence others. This ability emphasizes on how we can behave and understand other people from the person's perspective so that we can acknowledge and approach people productively. Millennial generation do not get trapped by the phrase "be yourself" which makes themselves as the center of attention, to the extent that they do not care about the situation of others.

SEL-based schools involve practices and policies that help students and teachers to be able to obtain and apply knowledge, skills, and attitudes that improve self-development, social relations, ethical behavior, effectiveness, and being able to work productively [21]. SEL-based schools were developed to prevent school violence based on the belief that academic skills are

essentially related to the ability of young people to manage and regulate emotions, communicate, and respond to the challenges to solve problems and interpersonal conflict [14].

There are five generations that can be identified based on the theory of generations: 1) Generation of Veteran, born in 1925 – 1946, 2) Generation of Baby Boomers, born in 1946 - 1960, 3) Generation X, born in 1960 - 1980, 4) Generation Y, born 1980 - 1995, 5) Generation Z, born in 1995 - 2010, and 6) Generation Alpha, born in 2010 – 2025 [19].

Generation Alpha is also called as Net generation. Generation Alpha is a generation born after generation Z. This generation is also known as the most highly educated generation because they went to school earlier and learned a lot [24]. The changes in the behavior of the Net generation (another term generation Z) are: 1) Change in the way of learning, 2) Change in perspective, and 3) Change in boundaries [24]. Generation Alpha is a generation that fully lives out of digital culture. They are also referred to as "Generation of Glass" because their glass devices will be their main communication medium [28].

Today's daily life is close to visuals, such as games and television. In primary and secondary schools, Generation Alpha will move from a hearing learning method that is structured to a direct visual method [28]. Generation Alpha's learning style is virtual. They are very close to visual learning media. Communication as the core of social skills should be conveyed in a visual approach.

Visual communication is the process of sending and receiving messages using images. Visual literacy is defined as "the ability to build meaning through visual images". To give meaning to an image, the reader uses critical abilities of exploration, criticism, and reflection. Visual communication has many forms such as film, fashion, exhibitions, public monuments, interior design, advertising, and photography. Contemporary culture is very dependent on visual, especially the ability to communicate instantly and universally [24]. Visual language is a universal language.

Generation Alpha prefers to communicate visually through images or audio (sound) rather than text messages. In addition to "technology literacy", they need more attention because they tend to be raised with various conveniences and indulgence [24]. The characteristics of Generation Alpha according to Barkowitz (2016), among others are: 1) not like the principle of sharing (in an economic context), 2) smart, 3) ignoring privacy, 4) disliking regulations, 5) breaking all forms of restrictions or restraints, 6) be aware of health functions so that they tend to choose fresh and natural foods or drinks, 7) rebellion in religious rituals, 8) able to innovate with items that have been used, 9) like "Screen slightly" rather than touch screen, 10) like something which can be enjoyed over and over again like a "one-shot" movie rather than a series of films, 11) living at the present time, forgetting the past, having no concept of the future, and 12) growing rapidly [24].

Schawbel (2014) stated that Generation Alpha has more opportunities and challenges. Five things related to this generation are: 1) entrepreneurial generation, 2) vaying

more technological intelligence and relying heavily on social media, 3) prefer shopping online, 4) more spoiled and influenced by parents, 5) can meet their own needs, more educated, and better prepared to face big challenges [24].

The objective of the SEL development model is to develop students' physical, emotional, social, creative, spiritual, and intellectual aspects optimally. In addition, it also aims to shape human beings into true learners (lifelong learners). Meanwhile, students with low social-emotional understanding tend to experience various behavioral problems [23]. The influence of technology will give someone the opportunity to grow rapidly, but it can also have an impact on the problem of personal character [24].

Smartphones are repeatedly linked to causes of depression, cognitive impairments, sleep disorders, anxiety, and poor academic performance [13]. One of academic performances including identifying emotions that is in SEL core [22]. Digital communication is increasingly connected to the daily behavior of adolescents. 92 percent of adolescents aged 13-17 years are on the network every day. 88 percent of teens now have or can access Smartphones [9]. Although in the present time, in 2019, the Gen-A age range is between 0-9 years, but it does not rule out the negative impact that the device will have on them, as explained by previous facts. Moreover, Gen-A is predicted to live with technology as a digital native, no longer as a digital immigrant. Therefore, it is very important to develop SEL in the perspective of Islamic Education that is in accordance with Gen-A.

Affective skills include interpersonal skills (social intelligence) and intrapersonal skills (emotional intelligence) [18]. Soft skills have more influence than hard skills on someone's life. In other words, the emotional and social intelligence (soft skills) in determining the success or failure of a person is higher than the intellectual intelligence (hard skill) [18].

Table 1
Categories and Examples of SEL Competencies

	Intrapersonal: Knowledge, Skills, and attitudes directed toward oneself	Interpersonal: Knowledge, skills, and attitudes directed toward other people, institutions, or social structures
Awareness: Mindsets, knowledge, beliefs, or understandings	Intrapersonal Awareness (e.g., growth mindset, self-efficacy)	Interpersonal Awareness (e.g., empathy, social awareness)
Skills: Learned abilities to carry out a task with intended results or goals	Intrapersonal Skills (e.g., self-control, goal-setting, stress management)	Interpersonal Skills (e.g., social perspective taking; collaborative problem-solving)

Theory of Change (ToC) articulates what improvements will occur as a result of implementation actions or interventions. ToC can be used as a blueprint to bring stakeholders together, program planning and research, program implementation, assessment, and evaluation [16]. When creating a ToC, stakeholders are demanded to think

about how their long-term goals will be achieved, starting with specific implementation actions and following to the expected future changes over time leading to long-term goals. ToC must guide assessment options to evaluate and encourage the improved practice. By using ToC from a widely known SEL program called RULER as an example (see figure below), we see that several types of assessments are needed to continually improve implementation and monitor progress towards the achieving results.

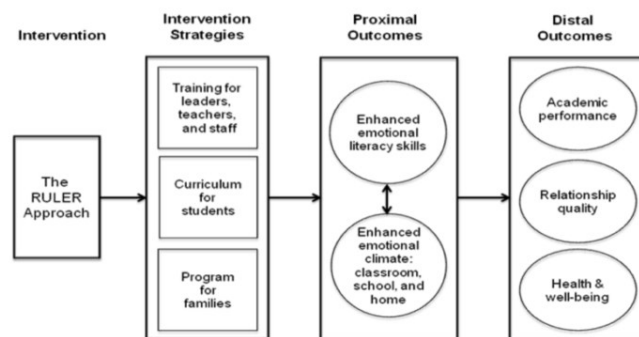

Fig. 1. RULER

First form of SEL development is integrated approach. Characteristics of child development are holistic or integrated, meaning that one aspect to another is interrelated, one aspect of development influences and is influenced by other aspects of development. Matching learning is integrated learning based on themes, because through children's themes, it is easier to build concepts about objects or events that exist in the environment. With integrated learning from an early age, children are trained to associate information with one another so that they can naturally encounter different situations, and at the same time, be able to learn actively and be directly involved in real life. Moreover, this learning can touch all aspects of a child's intelligence.

Second form of SEL development is routine approach. This approach is often referred to as habituation which is conducted by way of continuous scheduling until the expected behavior patterns become a positive habit for every child. *Third* form of SEL development is programmed approach. The implementation of this approach is applied through programmed activities that are made in a planned manner, becoming the main target or agenda when the program is implemented. Learning can be designed in the syllabus, both for long and short periods of time.

Fourth form of SEL development is spontaneous approach. A spontaneous approach is learning that is developed to respond to a direct stimulus from a child as a consequence of a dynamic learning context. It is important to conduct spontaneous learning because it provides a very high effect of satisfaction on children. *Fifth* form of SEL development is exemplary approach. Learning is displayed through good examples and uses that are easily accepted by the community according to the particular standards and value systems. This approach is important because older children are great imitators and easily absorb from what they see.

One of the expected skills of educators is their ability to choose the most appropriate learning method for their students. The ability that should be possessed by educators in applying SEL is: 1) have a good understanding of learning systems with integrated concepts, 2) able to design learning themes according to the needs of students, 3) understand the character of each student, 4) creative in varying teaching materials, 5) able to use various learning strategies, especially active learning.

The SEL strategy and method that can be applied by educators is as follows: a) applying learning methods that involve active participation of students that is methods that can increase student motivation because all human dimensions are actively involved with given material that is concrete, meaningful, and relevant in the context of life (student active learning, contextual learning, inquiry-based learning, and integrated learning); b) creating a conducive learning community, so that children can learn effectively in an atmosphere that provides security, appreciation, without threats, and encourages; c) providing character education explicitly, systematically and continuously by involving aspects of knowing good, loving the good, and acting the good; d) teaching methods that concern on the uniqueness of each child that is by applying a curriculum that involves nine aspects of human intelligence; and e) the entire approach above applies the principle of developmentally appropriate practices [16].

Social development can be applied through stages of social games, such as personification games and traditional games. This SEL development can be used to improve national character education. It is as expressed by John Pelliteri, et al (2006) who argued that SEL is one approach to character education. Therefore, SEL is very effective in improving the character education of the Indonesian human resources. The methods that can be used to help the process of developing social emotional learners include: singing and playing music, role playing, storytelling, motion games and songs, and hand puppets. Parents at home can also develop children's social emotional abilities through Montessori activities and introduce children to the surrounding environment.

The continuation of character education in schools can be divided into several forms: 1) Religious activities, 2) Daily habituations, 3) Classroom learning, and 4) Exemplary, both from teachers and education staff [18]. Islamic Education lessons in Elementary School include material of: 1) *Aqidah*: discussing six pillars of faith, 2) Morals: morals to Allah and His creatures, 3) Worship: includes worship of *mahdhah* and *ghairu mahdhah*, 4) Qur'an and Hadith: reciting, writing, memorizing, and understanding Qur'anic verses and hadith editors, 5) History: reviewing the history of Islamic civilization [18].

The SEL approach ensures students to effectively apply knowledge, behavior, and skills to understand and control emotions, empathize with others, build and achieve positive goals, and make responsible decisions. The classrooms that contain relationships between students and teachers are well interwoven and will improve the quality of student learning. Students who feel comfortable with their teachers and peers

tend to perform better in encountering challenges and persevere in overcoming difficult learning tasks [20].

Introducing a SEL program to teachers, students, parents, and school institutions is certainly beneficial - both for students with rich and poor backgrounds. SEL provides positive effects such as increasing student performance in the classroom, increasing the number of alumni, standardizing academic performance, preparing for further studies, and preparing for work [20].

Figure 2. The Prosocial Classroom Model

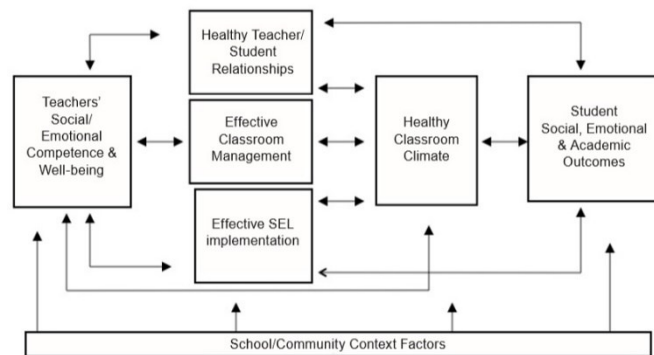

Fig. 2. The Pro-social Classroom Model

Teacher's social-emotional competency can be seen from how the teacher interacts with students [20]. Teacher's confidence influences the success of the SEL program [20]. Teacher preparation in conducting SEL programs is to have insight into the development of children or students and to have knowledge of students' SEL and classroom management [20]. After mastering SEL learning pattern, teachers should implement SEL to students which includes five core competencies as listed below:

Table 2
SEL Competencies

SOCIAL AND EMOTIONAL LEARNING COMPETENCIES				
Self-awareness	Self-management	Social awareness	Relationship skills	Responsible decision-making
Identifying emotions	Impulse control	Perspective-taking	Communication	Identifying problems
Accurate self-perception	Stress management	Empathy	Social engagement	Analyzing situations
Recognizing strengths	Self-discipline	Appreciating diversity	Relationship-building	Solving problems
Self-confidence	Self-motivation	Respect for other	Teamwork	Evaluating
Self-efficacy	Goal-setting			Reflecting
	Organizational skills			Ethical responsibility

The table below explains about values in Basic Competencies of IE that students should have [25]:

Table 3
Competency Standards and Basic Competencies of IE

Competency Standards of Good Behavior (<i>Akhlak</i>)	Values in Basic Competencies
First grade	Honest, responsible, discipline, clean life, diligent, mutual help, respect, civilized
Second grade	Humble, modest, civilized, politeness
Third grade	Confident, diligent, frugal, loyal, hard work, loving
Fourth grade	Imitate the prophet: Adam, Muhammad saw, Ibrahim, Ismail
Fifth grade	Imitate the prophet: Ayub, Musa, Isa. Imitate the caliph: Abu Bakar, Umar
Sixth grade	Avoid spiteful, lies. Persistence, mutual help

In applying social-emotional learning there are several factors that must be considered: (1) understanding the social identity and context to enhance the social skills for students; (2) the material is explained sequentially based on the experiences that students have learned before; (3) development of learning that includes five core competencies of social-emotional skills; (4) effective learning practices that show real examples; (5) create a scoring system that focuses on the quality of student learning (learning process).

The evaluation of SEL can be implemented using formative assessment. Educators can measure how SEL implementation affects instruction and whether adjustments need to be performed. Formative assessment can be considered as an assessment for learning. Summative assessment can be applied to provide information to stakeholders regarding the progress of educational output through SEL approach. In addition, another thing that needs to be considered is the evaluation of program effectiveness and SEL approach in teaching and learning activities.

The school's innovation process is by searching for identity, both by reflecting on history, community needs, and the future [26]. The following are some schools that have succeeded in finding their identity, so that they are responsive in responding to community needs and future challenges. The first two were found from newspaper, while the last three were from interview.

The SEL approach is similar to the Fun School Movement (FSM) conducted by teachers at Muhammadiyah 16 Surabaya Elementary School, known as "creative school" also applies the concept of fun learning or edutainment [32]. Learning does not have to be in the classroom, it can be outside the classroom or the surrounding environment. More interestingly, Muhammadiyah 16 Surabaya Elementary School invited outside teachers (guest teachers) to teach by adjusting certain themes, for instance, implementing applicative creative learning with musical drama models.

It is the same as Muhammadiyah Bausasran Elementary School. The school academicians are given freedom to be creative in creating a pleasant school [27]. The impact is in the increase of school performance and a comfortable environment. Suwarjo, Head of Muhammadiyah Bausasran Elementary School, said that one important part of FSM that needs to be considered is that principals are required to be friendly and humane.

We also conducted a brief interview with one of the teachers at Pertiwi Gondanglegi Tempel Kindergarten, Reni Nur Hidayati, regarding the methods or strategies used and what obstacles were experienced during implementing SEL program in the process of teaching and learning activities in the classroom. She said that the methods used were habituation methods, exemplary, playing projects, and role playing. Meanwhile, in implementing the strategy, she did not experience significant obstacles. The school also conducts SEL program in the form of fun competition, outside the learning and teaching process in the classroom. The students take some balls and put it into baskets according the colors. The teachers evaluate students' SEL through observing and habituation. They have affective reports for each student from individual assessment.

IV. CONCLUSION AND RECOMMENDATION

Thesuggestions and recommendations for future readers , researchers, educators, and parents are it is recommended to read and study books on social emotional issues. It is expected that educators and parents can work together in building the quality of the nation's children towards a better direction in accordance with the demands of the developing era. Additional recommendations specifically are conducting training for teachers related to the implementation of social emotional learning (SEL), creating a game application that contains SEL, and for teacher, it is expectedto offer information with infographic models. Video is a powerful program to support SEL [14]. Teachers and parents can consider starting to use video as SEL media, such as movie learning.

The learning should use games or various methods, such as musical drama performed by Muhammadiyah 16 Surabaya Elementary School. In the musical drama, the teacher can ask the students so that the plot of the drama adapts to the context of Islamic Education subjects. In addition, students choose emoticons at the beginning of lesson so that teachers can use strategies and learning methods according to the mood of the students.

In conveying information related to the subject matter, teachers need to be provided with training in making infographics so that the material presented or displayed is not monotonous only from books or presentation slides. Infographics is a form of data visualization that conveys complex information to the reader so that it can be understood more easily and quickly. Delivering information through infographics is certainly more interesting and concise. For the alternative, if making infographics is difficult, we can use mindmap to provide information or subject matter. Mindmap can be made simply on blank paper, but recently, mindmap is also available online so we only need to access the pieces of information that will be created. Then, the pieces of information will be in the form of mindmap.

Furthermore, we need to develop a variety of new literacy, not just old literacy (reading, writing, counting). New literacy includes data literacy, technology literacy, and human literacy. Data literacy is important to learn so that Gen-A is able to read, analyze, and use information in the digital world. Technology literacy is studied in order to

understand the way in operating machinery or application technology. Human literacy, which is equally important, is learned so that Gen-A can function properly in the community.

There are two solutions to SEL development for Gen-A. *First*, blended learning teaching system through SPADA-IdREN (online learning system, such as video conference, online learning, resource sharing). *Second*, reorientation of the curriculum in the form of: 1) teaching and developing three new literacy (data, technology, human), 2) development of cooperation in teams and leadership through extra-curricular activities, 3) obliging entrepreneurship and internship [29]. Then, adjust the Islamic Education lesson with the existing blended learning teaching system. Finally, Islamic Education institutions can be the most effective mouthpiece of propaganda for broadcasting (preaching) Islam [26]. Without the presence of Islamic schools, in Indonesia, there will be no so-called Islamic society.

REFERENCES

Books

- [1] Abdulhak, I., & Darmawan, D. (2013). *Teknologi Pendidikan*. Bandung: PT Remaja Rosdakarya Offset.
- [2] Berelson, B. (1952) *Content Analysis in Communication Research*. New York: Free Press.
- [3] Nawawi, H. (1993). *Metode Penelitian Bidang Sosial*. Yogyakarta: Gadjah Mada University Press.
- [4] Nucci, L. P. (2008). *Handbook of Moral and Character Education*. New York and London: Routledge.
- [5] Pellitteri, J., Stern, R., Shelton, C., & Muller-Ackerman, B. (2006). *Emotionally Intelligent School Counseling*. London: Lawrence Erlbaum.
- [6] Sadulloh, U. (2011). *Pedagogik*. Bandung: Alfabeta.
- [7] Sugiyono. (2009). *Metode Penelitian Pendidikan*. Bandung: Alfabeta.
- [8] Zed, M. (2004). *Metode Penelitian Kepustakaan*. Yogyakarta: Yayasan Obor Indonesia.

Journal Articles

- [9] Charmaraman, L., Gladstone, T., & Richer, A. (2018). Positive and Negative Associations Between Adolescent Mental Health and Technology. *Technology and Adolescent Mental Health*, 61-71.
- [10] Cristea, G. (2013). The Psychological Pedagogy Paradigm. *Procedia: Social and Behavioral Sciences*, 233-236.
- [11] Dewi, T. A. (2016). Upaya Pembentukan Karakter Melalui Social and Emotional Learning (SEL) pada Mata Pelajaran IPS di SMP. *Jurnal Promosi: Jurnal Pendidikan Ekonomi UM Metro*, 4(2), 13-22.
- [12] Durlak, J. A., Roger, W., Allison, D., Rebecca, T., & Kriston, S. (2011). The Impact of Enhancing Students' Social and Emotional Learning: A Meta-Analysis of School Based Universal Interventions. *Child Development*, 82(1), 405-432.
- [13] Ellis, D. A. (2019). Are Smartphones Really That Bad? Improving The Psychological Measurement of Technology-related Behaviors. *Computers in Human Behavior*, 4-29.
- [14] Espelage, D. L., Rose, C. A., & Polanin, J. R. (2015). Social-Emotional Learning Program to Reduce Bullying, Fighting, and Victimization Among Middle School Students With Disabilities. *Remedial and Special Education*, 36(5), 299-311.
- [15] Gazali, E. (2018). Pesantren di Antara Generasi Alfa dan Tantangan Dunia Pendidikan Era Revolusi Industri 4.0. *Oasis: Jurnal Ilmiah Kajian Islam*, 2(2), 94-109.
- [16] Hagelskamp, C., Brackett, M. A., Rivers, S. E., & P. S. (2013). Improving Classroom Quality with The RULER Approach to Social and Emotional Learning: Proximal and Distal Outcomes. *Am J Community Psychol Journal*.

- [17] Khilmiah, A. (2013). Model Pembelajaran PAI dengan Pendekatan Social Emotional Learning (SEL) untuk Memperkuat Karakter dan Akhlak Mulia Siswa Sekolah Dasar. *Didaktika Religia: Journal of Islamic Education Sekolah Tinggi Agama Islam Negeri Kediri*, 1(1), 1-13.
- [18] Khilmiah, A., Syamsuddin, M., & Wiyono, G. (2017). Revolusi Mental Guru Pendidikan Agama Islam Dalam Penguatan Karakter Melalui Penerapan Social Emotional Learning (SEL). *Jurnal Berdikari*, 5(2), 137-149.
- [19] Putra, Y. S. (2016). Theoretical Review: Teori Perbedaan Generasi. *Among Makarti*, 9(18), 123-134.
- [20] Schonert-Reichl, K. A. (2017). Social and Emotional Learning and Teachers. *The Future of Children*, 27(1), 137-155.
- [21] Taylor, R. D., Durlak, J. A., Oberle, E., & Weissberg, R. P. (2017). Promoting Positive Youth Development Through School-Based Social and Emotional Learning Interventions: A Meta-Analysis of Follow-Up Effects. *Child Development*, 88(4), 1156-1171.

Proceedings

- [22] Harmer, S. L., & Grunenfelder, D. (2009). Social and Emotional Learning for School and Life Success. *OSPI Conference* (pp. 1-51).
- [23] Purna, R. S. (2016). Pengembangan Social Emotional Learning (SEL) di Sekolah. *Prosiding Inovasi Pendidikan di Era Big Data dan Aspek Psikologinya* (pp. 409-416). Malang: Universitas Negeri Malang.
- [24] Ramadani, A. K., & Wibisono, M. (2017). Visual Literacy and Character Education for Generation Alpha. *International Seminar on Language, Education, and Culture* (pp. 1-7). Malang: Faculty of Letters, Universitas Negeri Malang.

Research Reports

- [25] Khilmiah, A., & Hapsari, T. B. (2015). Pengembangan Model Pembelajaran PAI dengan Pendekatan Social Emotional Learning (SEL) untuk Membentuk Karakter dan Akhlak Mulia Siswa Sekolah Dasar di DIY (Final Report of Competitive Grants). Yogyakarta: Universitas Muhammadiyah Yogyakarta.

Newspapers

- [26] Ali, M. (2019, June 18). Pesona Sekolah Islam. *Republika*.
- [27] Ria (2019, July 2). Wujudkan 'GSM': Warga Sekolah Harus Dibebaskan Berkreasi. *Kedaulatan Rakyat*.
- [28] Sopia, Santi (2019, June 18). Mengenal Alfa: Generasi Paling Kaya. *Republika*, p. 15.

Website Materials

- [29] Kementerian Riset, Teknologi, dan Pendidikan Tinggi. (2018). Proses Pembelajaran Digital dalam Era Revolusi Industri 4.0. Medan: Intan Ahmad. Retrieved July 12, 2019, from http://kimia.unnes.ac.id/v1/wp-content/uploads/2018/02/V11-Dirjen-Belmawa-IA_Belmawa-Rakernas-Ristekdikti-Medan-Final-16-01-18.pdf
- [30] Columbia University Mailman School of Public Health. Content Analysis. New York. Retrieved July 12, 2019, from <https://www.mailman.columbia.edu/research/population-health-methods/content-analysis>
- [31] The National Center for Education Evaluation and Regional Assistance. (2017). *Descriptive Analysis in Education: A Guide for Researchers*. Washington, DC: Susanna Loeb, Susan Dynarski, Daniel McFarland, Pamela Morris, Sean Reardon, Sarah Reber. Retrieved July 14, 2019, from <https://files.eric.ed.gov/fulltext/ED573325.pdf>
- [32] [32] Majalah Nurani (2018). Sekolah Kreatif SD Muhammadiyah 16 Surabaya, Konsep Belajar Kreatif dan Atraktif. Surabaya: Nurani. Retrieved July 12, 2019, from <https://majalahnurani.com/2018/01/02/sekolah-kreatif-sd-muhammadiyah-16-surabaya-konsep-belajar-kreatif-dan-atraktif/>
- [33] Sun Education Group. (2017). Pentingnya EQ untuk Meningkatkan Kualitas Diri Generasi Milenial. Jakarta: SJV. Retrieved July 12, 2019, from <https://suneducationgroup.com/news-id/gaya-hidup-id/meningkatkan-generasi-milenial/>

Android-Based Voice Dictionary Application as a Media to Learn Indonesian Languages for Foreign Speakers

¹Tri Wahyono, ²Fitroh Anugrah Kusuma Yudha, ³Yashinta Farahsani
Universitas Muhammadiyah Yogyakarta

¹wahyonotri25@gmail.com, ²yudha2.91@gmail.com, ³yashintahime@yahoo.com

Abstract-Learning activities to speak Indonesian for foreign speakers have been carried out in a conventional way so that the presence of the teachers is still highly needed. Consequently, learning activities require learning media that can support speaking skills. One A learning media alternative that is widely used in various learning activities is information technology. Android-based voice dictionary application is one of the media to learn speaking by utilizing the development of information technology. The development of this application is done by inputting voice data from words, letters, and numbers in Indonesian. This voice dictionary media application can be accessed offline through mobile phone so that it can be used without limitation of time and place. With this voice dictionary application, foreign speakers can learn to speak independently by listening to the speech sounds of the words that are available.

Keywords: design, learning media, voice dictionary application

INTRODUCTION

Foreign speakers who begin to learn to speak Indonesian sometimes still experience difficulties. This is due to the differences in the pronunciation of letters, numbers, and words. It may become more difficult as the same letters and numbers in Indonesian have some different pronunciation. That is the obstacle experienced by foreign speakers who want to speak in Indonesian. A person's speaking skills are strongly influenced by his ability to listen to the sounds of speech. The more people listen to the speech sounds of other languages, the faster the learning process of speaking a foreign language. However, the process of learning to speak must be balanced with the supporting media in practicing pronunciation.

One factor that greatly influences a person's speaking skills is the input received, both from audiovisual media and from the surrounding environment. The implementation of speaking learning will be able to run well if the instructor understands the learning principles as follows (a) the psychological maturity of the learner in speaking, (b) the learner's involvement in various contexts, (b) the application of interactive learning patterns, (c) speaking strategies, (d) direct practice, (e) continuous learning

process, (f) the formation of learner's skills and creativity (Abidin, 2013: 135).

Indonesian language learning methods used so far tend to be conventional. The learning system is very dependent on the presence of the teacher. In fact, the learning process can not only be done in class, but it can also be done in various places anytime and anywhere. The process of learning to speak conducted outside the classroom can be done with the help of the community or learning media that support Indonesian speaking competence for foreign speakers. Lately, the learning method that is being used is by utilizing information technology. Electronic learning is a learning activity that allows teaching materials to be delivered to students through internet media, intranets, or computer network media and other software (Hartley in Iqbal, et al., 2016).

Svinicki and McKeachie (2011:262) stated that technology can provide implications that are potentially easier for teachers in facilitating learning processes. Teachers can also apply learning and mentoring materials according to the competencies that are being taught. In addition, learning technology also has some implications in determining learning objectives. As such, audiovisual media applications are expected to help foreign speakers who are learning to speak Bahasa Indonesia.

One of the alternatives that can support the learning process of speaking Bahasa Indonesia for foreign speakers is through with audiovisual application media using smartphones based on Android. In recent decades, mobile devices are increasing. This condition opens the opportunity to use mobile technology devices in education. The use of mobile devices in the learning process is known to be the ("M-Learning") (Gorgiev, et al. in Purbasari, et al., 2013).

In addition, O'malley (in Purbasari, et al., 2013) stated that mobile learning is a learning that requires students/learners to be active. The presence of M-learning will not be able to replace the learning with face-to-face in the classroom. However, M-learning is aimed at providing complementary learning that gives students the opportunity to re-learn less-mastered material anywhere and at anytime. This can certainly provide a different experience in the learning process for students.

One of the alternatives that can support the learning process of speaking Indonesian for foreign speakers is by using an android-based voice dictionary application. In its use, mobile learning systems have advantages such as low usage costs, ability to support multimedia material content, and the accessibility in using it in various places. In addition, mobile learning devices are also lighter when compared to books, laptops, or other computer devices. However, mobile learning also has several disadvantages such as battery life, screen size, limited format support, and limited data storage memory (Yuntoto, 2014).

Based on this background, the purpose of this study was to reduce the difficulties experienced by foreign learners in speaking Indonesian and to find out the process of media-based audiovisual application modeling in order to facilitate foreign speakers in learning to speak Indonesian. The results of this study are also expected to be a new learning media that can be used to teach Indonesian speaking skills for foreign speakers.

RESEARCH METHODS

This applied research used software to create an audiovisual media application based on Android to improve speaking skills for foreign speakers. The research process was carried out by inputting the types of letters, numbers, and words in Indonesian that are equipped with speech sounds through recording. The audiovisual media was developed in the form of applications that can be accessed from mobile phones.

The process of designing the application media also considered the aspects of the media that are interactive, interesting, easy to use, and on target so that it needs to be directed using the multimedia development life cycle method. According to Luther's version, the stages in conducting the research consisted of six stages including concept, design, collecting materials, assembly, and matching testing with the making of Android-based learning multimedia applications (Wardan and Kurniadi, 2017). Here are the steps for developing android-based dictionary application media.

Diagram 1. Stages of designing android-based audiovisual application media

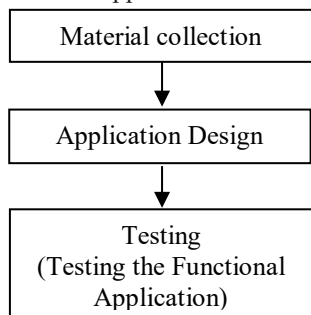

At the final stage, the functional test application of the instrument used was a questionnaire. Thus, the trial subject will be able to provide an evaluation so that the process of developing an Android-based audiovisual application media can be measured for its quality.

RESULTS AND DISCUSSION

Pronunciation Difficulties for Foreign Speakers

Foreign learners often experience difficulties in pronouncing vowels [a], [i], [u], [e], and [o] because they are still affected by pronunciation in English or their native language. In addition, in Indonesian, the pronunciation "e" has three sound variation, namely [e], [ə], and [ɛ]. This makes it difficult for the learners to use which the sound is used to say a word. In some words, the sound [e] changes to [a]. In addition to difficulties in pronouncing vowels, the learners also have difficulties in pronouncing diphthong sounds, namely the sound of two vowels, for example "oi", "ai", "au", and "ua".

Foreign speakers also experience difficulties in pronouncing palatal and nasal sounds. The learners experience difficulties in pronouncing sounds "ng" [ŋ] and "ny" [ɲ]. The pronunciation of the sound "ng" [ŋ] and "ny" [ɲ] is not perfect so that the foreign speakers pronounce the words in double "g" sound or they pronounce the words in separated sounds of "n" and "g" and between the letters "n" and "y", as in the word *menyanyi* and *bunga*. The pronunciation of these words is still considered difficult by foreign learners because of the appearance of the same consonant. In addition, the learners also have difficulties in pronouncing words in which there are repetitions of the consonants "ng" as found in the words *dingin*, *bunga*, *mengedit*, *mengundang*, *sangat*, *bangun*, *lingkungan*, *belakang*, *dengan*, *menyeberang*, and *mengundang*. Another difficulty is also found in pronouncing the sound "ny" as found in the words *nyaman*, *menyanyi*, *menyeberang*, *menyiapkan*, and *warnanya*. The learners also still experience difficulties in pronouncing consonant letters or cluster sounds, such as the sound of the letter "g" in the words *menggeser*, *menggali*, and *menggambar*.

Designing the Voice Dictionary Application

The design of the voice dictionary application can be done by installing an application program that can be accessed using a smartphone that has an integrated android system. The following is an application program that can be uploaded from Playstore. The application program used is called MIT AI2 Companion.

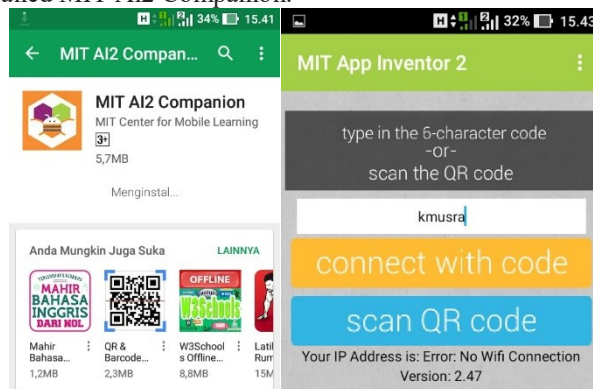

Figure 1. Installation of the voice dictionary supporting application program

The next stage is to combine sound components with text written in the text field. Next, the stage is the is the process

of combining text and sound components. At this stage, the process of combining components between text and sound can be carried out in large quantities. However, it must be adapted to the space capacity provided in the program.



Figure 2. Process of Sound Component Input

The last step is synchronizing the dictionary sound program that has been combined between the text and sound. The results of the programming can be seen in the following display. The trial process can be done through a smartphone by opening the available icon and activating the volume so that the results of the voice dictionary programming can be used properly.



Figure 3. Results of Input and Synchronization of Text and Sound Components

After the trial process through the media of laptops and smartphones is successfully done, the voice dictionary can be accessed through via a smartphone integrated with an android system anywhere. Voice dictionary can be opened through a special icon that can be seen on the main screen on the smartphone that has the application installed. This voice dictionary can not only be used independently, but it can be also widely used for conventional learning activities because sound output can be connected to larger speakers so that it can be heard by many people.

CONCLUSION

Based on the results of these studies, the speakers no longer have difficulties in learning to speak Indonesian. In addition, the learning process of speaking foreign speakers is increasingly easy to do by utilizing the voice dictionary application that can be accessed through a smartphone that has been integrated with the android system. The voice dictionary application that has been designed is still a prototype. The researchers expect that there will be an opportunity to develop into a more comprehensive application so that it can be fully utilized by foreign speakers who are learning to speak Indonesian.

BIBLIOGRAPHY

Abidin, Yunus. 2013. *Pembelajaran Bahasa Berbasis Pendidikan Karakter*. Bandung: Refika Aditama.

Iqbal, M, Yuzrizal, dan M. Subianto. 2016. Perancangan Media Pembelajaran Aplikasi Fisika pada Pokok Bahasan Fluida Statis untuk Siswa SMA Berbasis Android. *Aceh: Jurnal Pendidikan Sains Indonesia*, Vol. 04, N0. 02, hlm 20-24. Prodi IPA, PPs Unsyiah.

Purbasari, Rohmi Julia, dkk. 2013. *Pengembangan Aplikasi Android sebagai Media Pembelajaran Matematika pada Materi Dimensi Tiga untuk Siswa Sma Kelas X*, (Artikel Ilmiah). Malang: FMIPA UM.

Svinicki, Marilla dan McKeachie. 2011. *Strategies, research, and theory for college and university teachers*. : United State of America.

Wardan, Randi dan Dede Kurniadi. 2017. *Aplikasi Multimedia Pembelajaran Rambu Lalu Lintas Berbasis Android*. *Jurnal Algoritma*. Vol. 14 No. 2. Hlm. 1-8. Garut: Sekolah Tinggi Teknologi Garut.

Yuntoto, Singgih. 2014. *Pengembangan Aplikasi Android sebagai Media Pembelajaran Kompetensi Pengoperasian Sistem Pengendali Elektronik pada Siswa Kelas XI SMKN 2 Pengasih*. Yogyakarta: Prodi Pendidikan Elektro, FT, UNY

Self Confidence, Fighting Power, and Achievement Motivation of the IKIP PGRI Pontianak Students in Completing the Study in 2017/2018 Odd Semester

Hamid Darmadi
IKIP PGRI Pontianak
hamiddarmadi@gmail.com

Abstract. This research is titled "Self Confidence of Future Power and Student Achievement Motivation IKIP-PGRI Pontianak Completes Odd 2017/2018 Semester Study". Problems in this study "How . "Self Confidence of Future Power and Student Achievement Motivation IKIP-PGRI Pontianak Completes Odd 2017/2018 Semester Study". This study aims to obtain information and objective clarity about: "Self-confidence and Fighting Motivation for the Achievement of Pontianak IKIP-PGRI Students Complete Timely Studies. The benefits of this study are viewed from two Aspek, namely: Theoretical and Practical benefits of using the descriptive method. The population in this study numbered 100 people. The technique and data collection tools used a rating scale to measure "Fighting Self-Confidence and Competition Motivation in Pontianak IKIP-PGRI Students Complete Timely Study". Deep data analysis this research uses qualitative and quantitative descriptive methods. The results of the study showed that the Confidence of Fighting Power and the Achievement of the Motivation of Pontianak IKIP-PGRI Students Completed Timely Study in the category "Enough". As the effect of self-confidence and independence of learning in Pontianak IKIP-PGRI students in completing their studies on time is relatively sufficient. Study period students complete their study averaging between 4.5 and 5 years of study. Fighting Power Aspek Pontianak IKIP-PGRI students completed their initial assignments and their final assignments were relatively low. There are still many students who are late completing their final assignments (writing Thesis). The study period which should be completed from 3.5 to 4 years stretches to 5 to 6 years. Motivational and Spiritual Aspects Learning to take lectures is "enough". It was found that students were not on time to attend classes, the lack of students asking questions in attending lectures and lack of courage students expressed their opinions both in presentations and in group discussions.

Keywords: *Self-confidence Motivation for Students to Complete the Study*

I. Introduction

Each student basically has the urge to carry out learning activities in order to achieve the life goals he wants. The encouragement functioned as a motivation for the student to achieve desire. As revealed by Hamzah B. Uno (2008: 1) "motivation is a basic impulse that moves a person to behave, this drive is in someone who moves to do something in accordance with the encouragement in him". Likewise, Sumadi Suryabrata (1986: 72) explains, "Motivation is a

condition in one's person, which encourages him to do certain activities in order to achieve a goal".

Based on the opinions above, motivation is a basic impulse that moves a person to act to achieve the desired goal. Motivation starts from the feeling of wanting or not doing an action. As revealed by McDonald's (in Oemar Hamalik, 2002: 173) "motivation is a change in energy in a person's person which is characterized by the emergence of affective and reaction to achieve goals". In relation to learning motivation is one of the factors that influence the process and learning outcomes that lie in the psychological aspects of students, as expressed by Muhibbin Shah (1995: "Many factors influence the quantity and quality of student learning outcomes. However, what is more essential include: student intelligence, attitudes, talents, student interests and student motivation".

Reality in the field shows that students are still low or lacking motivation in learning. For example students are often late, skipping, lazy to do lecture assignments, not concentrating in the lecture process, are in the classroom but do not understand lecture material, lecturers who rarely enter, and others like it. Confidence is the quality needed to make someone become a person who believes in himself and is responsible. However, self-confidence is not something that can be taught to people from day to day, but must be cultivated starting from childhood. Self-confidence does not just appear in a person, but requires a certain process in his person so that there is a formation of self-confidence. Strong self-esteem occurs through the process: The formation of a good personality in accordance with the development process that gives birth to certain excess advantages. A person's understanding of the strengths he has and giving birth strong belief in being able to do everything by utilizing the strengths of its strengths. Understanding and positive reactions to one's weaknesses so as not to cause feelings of inferiority or feeling difficult to adjust. Experience in living various aspects of life by using all the advantages that exist in him.

Independence is an attitude that allows a person to be able to act freely, do something on their own and for their own needs without help from others, and think and act original / creative, and full of initiative, able to influence the environment, have confidence and gain satisfaction from his business. Psychological and mentalist independence is the condition of someone who in his life is able to decide and do something without help from others. Such ability is only possible if someone has the ability to think carefully about something he does or decides, both in terms of benefits or

benefits, as well as negative aspects and losses that will be experienced (Hasan Basri, 2000: 53). Every activity carried out by someone in order to succeed according to his desires requires strong independence.

Brawer in Chabib Toha (1993: 121) states that independence is a feeling of autonomy, so that the notion of independent behavior is a self-confidence, and feelings of autonomy are defined as behaviors that occur in a person that arises because the force of encouragement is not influenced by others. Kartini Kartono (1985: 21) added that a person's independence was seen when the person faced a problem. If the problem can be solved alone without asking for help from parents and will be responsible for all decisions that have been taken through various considerations, this indicates that the person is able to be independent. Strong belief in being able to do everything by utilizing the strengths of its strengths. Understanding and positive reactions to one's weaknesses are not to cause feelings of inferiority or feeling difficult to adjust. Experience in living various aspects of life using all the advantages that exist in him. Independence is an attitude that allows a person to be able to act freely, do something on their own and for their own needs without help from others, and think and act original creative, and full of initiative, able to influence the environment, have confidence and gain satisfaction from his business. Psychological and mental independence is a condition of someone who is able to decide something without help from others. It is only possible if someone has the ability to think carefully about something or not, both in terms of benefits or benefits, as well as negative aspects and losses that will be experienced (Hasan Basri, 2000: 53). Every activity is carried out by someone in order to succeed.

Brawer in Chabib Toha (1993: 121) states that independence is a feeling of autonomy, so that the notion of self-confidence is due to the force of encouragement is not influenced by others. Kartini Kartono (1985: 21) added that a person had a problem with independence. If the problem can be solved alone without asking for help from parents and will be responsible for all the decisions that have been taken through various considerations. The high and low self-awareness of fulfilling curiosity or the need for information, one of them is by asking questions. The importance of students asking in class also encourages interaction between students and lecturers to be more "warm" the learning process, students are involved directly and personally and are more responsible for the questions asked.

In UUGD No.14 Year 2005 said "Lecturers are professional educators and scientists with the main task of transforming, developing, and disseminating science, technology and art through education, research and community service. Lecturers have a position as professionals at the higher education level who are appointed in accordance with the laws and regulations ". Lecturers as transformers, develop, and disseminate knowledge, technology, and art through education, research and community service need to understand the characteristics of cognitive, affective and psychomotor students (students) integrally. Knowledge about psychology is also needed in the world of education

because the world of education faces unique learners seen in terms of behavior, independence, personality, attention, motivation and various other aspects of psychology that differ between individuals one to another individual. In students there is a psychological power that becomes a driver for learning. The driving force comes from various sources. Students are eager to learn because they are driven by their mental strength and independence. Mental strength and independence are in the form of desire, attention, motivation or ideals. This mental strength can be classified as low or high.

In the lecture room students consist of several groups who have the same abilities but differ in personality and their interests are very dependent on the presence or absence of that independence. In the classroom there may be some students who are able to motivate themselves because of independence. Such students do not need much help / guidance from lecturers to stimulate their interest in learning, because they are able to encourage themselves. Most students will have learning motivation if the lecturer uses various techniques to motivate them, but there are also a number of new students who will be motivated if the lecturers make special efforts for them. Therefore lecturers should understand this so that they can use various approaches to stimulate interest in learning, and be able to apply different principles and techniques according to the needs of each student.

The problem now is how to do various efforts to build and develop student motivation and independence of learning. Students will be motivated to learn if the surrounding environment can provide stimulation so students are interested in learning and independent. Lecturers must set the learning atmosphere wisely so students are motivated to learn.

Based on the observations of researchers lately there is a tendency for learning motivation, interest in learning and learning independence of students following the learning process in a relatively low class. Students are more likely to be passive and apathetic in following the learning process. They are reluctant to express opinions and do not like to ask questions, often move on their own, and tend to ignore lecturers who present lessons in front of the class. Such conversions will sooner or later affect the character and behavior of students who are expected to be the successors of the ideals of the nation.

Based on these conditions, researchers are interested in studying more about the concept of self-confidence, interest in learning, motivation and fighting ability of students in the learning process by lifting the title "" How "Fighting Confidence and Achievement Motivation for Pontianak IKIP-PGRI Students Complete 2017 Odd Semester Study / 2018)). "

A. Formulation of Problems and Sub Research Problems

It has been mentioned above that the common problem in this study is "How" Fighting Confidence and Achievement Motivation of IKIP-PGRI Students in Pontianak Complete Odd Semester 2017/2018 Study)). "With sub-problems of research as follows:

1. How are the Self-Confidence of Pontianak IKIP-PGRI students discussed through students' self-confidence in completing assignments given by lecturers both in assignments in lectures, discipline in lectures, and the activity of students reading compulsory books and books recommended by lecturers and the ability of students to conduct learning activities both within the Faculty and outside the Faculty (Campus).
2. How is the Fighting Power of Pontianak IKIP-PGRI students discussed through the fighting force of students to complete initial assignments and final assignments. seen from the relative number of students who delay completing their tasks, especially the final assignment (Thesis, KKM and integrated PPL), so the study period that should be completed 3.5 to 4 years stretches to 5 to 6 years or longer to get sanctions (DO)
3. How is the Motivation for Achieving Completion of Study of IKIP-PGRI Pontianak students discussed through "the motivation of students to follow the lecture process. Student activities ask in lecture activities and the ability of students to express their opinions in discussion activities both in group discussions in class and discussions outside the classroom self does not just appear (suddenly) in a person there is a certain process in his person so that there is a formation of self-confidence.

B. Research Objectives

This study aims to obtain objective information and clarity about: "Self-Confidence Fighting Power and Motivation to Participate in Students of IKIP PGRI Pontianak Complete their Study" 2017/2018 Academic Odd Semester "" in terms of:

1. Self-confidence of Pontianak IKIP-PGRI students in completing assignments given by lecturers, both assignments in lectures, discipline in lectures, and self-confidence as candidates for academic intellectuals
2. The fighting spirit of IKIP-PGRI Pontianak students in completing their initial and final assignments in terms of the number of students who delay completing their assignments on time.
3. Motivation for Achievement Completing the Study of IKIP-PGRI Pontianak students in following the lecture process, and the activity of students' ability to express their opinions in discussion activities both in group discussions in class and other discussions (outside the classroom).

C. Benefits of Research

This study was reviewed from two benefits, namely theoretical benefits and practical benefits.

1. The benefits of the results of this study can be used as a driver of action "How Self-Confidence Fighting and Motivation to Participate in Students of IKIP PGRI Pontianak Complete their Study" Odd Semester Academic Year 2017/2018 ". On the other hand the benefits of the results of this study can be used as a driver of self-confidence in motivating themselves to struggle to complete studies within the time limit set.
2. Can be used as a material for consideration to determine what actions should be done to support achieving the goal, by eliminating actions that are not beneficial to foster "Self-confidence Fighting Power and the

Motivation of Association of IKIP PGRI Students in Pontianak Complete Study" Odd Semester Year Academic 2017/2018 "".

II. Research Methodology

A. Research Populations and Samples

a. Population.

Population is a generalization area consisting of objects / subjects that have certain quantities and characteristics determined by researchers to be studied and then conclusions drawn. The population in this study is the first semester of Pontianak Pontianak Teachers and Teachers-PGRI students and the last semester of 2017/2018. Considering the relatively large number of Pontianak IKIP-PGRI students in the first semester and the last semester, 15 people were randomly conducted in each Study Program with the details of 5 students in the first semester and 10 students in the seventh semester so that the sample was 150 students.

b. Sample

The sample in this study were first semester students and semester students (VIII) who had participated in the integrated KKM and PPL 2017/2018 academic year as many as 150 students who had been designated as populations were all sampled. The questionnaire circulated to students in semester I and Semester VIII as many as 150 pieces according to the number of random samples that have been determined. The questionnaire returned as many as 135 pieces. After checking and validating questionnaire data, it turned out that Fifteen (15) questionnaires were not answered / not filled in, and 20 exemplar questionnaires were answered no, complete aliases were only partially answered. Therefore a questionnaire that meets the requirements to be processed is only as many as 100 sheets of questionnaires.

B. Techniques and Research Data Collection Tools

Data collection is an important step in research. The collected data is used as material for analysis and hypothesis testing. Therefore, data collection is carried out systematically, directed and in accordance with research problems. Data collection techniques are closely related to the research problems to be solved. Therefore, the selection of techniques and appropriate data collection tools needs to be prioritized. In this study the data collection techniques and tools used or considered appropriate (appropriate) with the data to be collected are:

1. Direct communication techniques with interview guides as a data collection tool. An interview is a process of oral questioning between two or more people directly. The interviewer is referred to as the interviewer and the person interviewed is referred to as the interviewee. Interviews were conducted with 5 students per Study Program. The purpose of the interview is to get data from first hand (primary), as a complement to other data collection techniques, to test the results of data that has been collected. The interview was carried out in the form of a voice recorder. The tool is used to record the answers given from the speakers, so that they will not lose information that has been obtained in the field. After getting the recording, the interviewer then writes the question and answer transcript

and then makes the data feasible as research information. Interview is a technique of collecting data by conducting communication with data sources. Such communication is carried out by dialogue (question and answer) verbally, both directly and indirectly (I.Djumbuh and Muh.Surya, 1985).

2. Indirect communication techniques with questionnaires as a data collection tool. The questionnaire is distributed to all (150) students who become the object of research. The purpose of questionnaires is the technique of collecting data by asking written questions to be answered in writing by respondents. Questionnaire is a collection of written questions that are used to obtain information from respondents about personal or things that respondents know. The purpose of the questionnaire is to find complete information about a problem and the respondent without feeling worried if the respondent gives an answer that is not in accordance with the reality in filling out the questionnaire. Besides that, the respondent knows certain information requested. In this study the researcher used a closed questionnaire. Closed questionnaire (structured questionnaire) is a questionnaire that is presented in such a way that the respondent (student) is asked to choose one answer that is in accordance with his characteristics by giving a cross mark or checklist.

3. The technique of direct observation with the observation guide as a data collection tool. Observation is carried out on student learning activities in the class that are the object of research. The purpose of observation is observing activities, followed by recording. This consists of several elements that appear in phenomena within the object under study. The results of the process are reported with a systematic and appropriate report (Nawawi and Martini 2008). The purpose of the observation is to find data and information in accordance with the research objectives.

4. Documentation techniques with data collection tools in the form of recordings, videos, photos of student learning activities, photos of student learning outcomes in the form of Mid semester scores and final semester test results both in each study program, in academic and student grades contained in Data base of IKIP-PGRI Pontianak. Study documents are intended to collect various types of data from various kinds of documents that are useful for analyzing data. Documents needed in data collection are divided into two, namely: Primary documents Secondary documents.

C. Data Analysis Techniques and Tools

The follow-up of this research activity after data collection varies greatly depending on how the collected data can be organized. In order for researchers not to stop their steps in confusion not knowing what to do next, then when compiling a research proposal these steps have been reflected in the design or design plan. Content analysis is a research technique to create inferences that can be replicated, and valid data by paying attention to the context. Content analysis relates to communication or content of communication. The basic logic in communication, that every communication always contains a message in the communication signal, both in the form of verbal and nonverbal. So far, the meaning of communion has become very dominant in every communication event.

Data Analysis Technique is a method or way to process a data into information so that the characteristics of the data become easy to understand and also useful for finding solutions to problems, which are mainly problems about a study. Or data analysis can also be interpreted as activities carried out to change the results data from a study into information used to draw conclusions.

The purpose of data analysis is to describe the research data so that it is easy to understand, and to draw conclusions to draw conclusions about population characteristics based on data obtained from samples made with the basis of estimation and hypothesis testing. Data analysis techniques that are in accordance with this type of research, namely qualitative data analysis techniques and quantitative data analysis techniques. The reason for using qualitative and quantitative is that not all data can be processed statistically otherwise not all data can be processed qualitatively.

III. Research Results

Based on the analysis of the data that: Fighting Confidence and Motivation "(Analytical Study on the Ability of Pontianak IKIP-PGRI Students to Accomplish Timeline in Odd Semester 2017/2018) is categorized as Enough" Specifically in accordance with the aspects of the study, this study can be presented as follows:

1. As the effect of self-confidence and independence of learning in Pontianak IKIP-PGRI students in completing their studies on time is relatively sufficient. This was shown by 100 students who were based on categorization as a matter of belief that there were only 2 students (2%) showing Self Confidence, 20 students (20%) Self-confidence, and 62 students (62%) showing high self-confidence and 16 students (16%) showed very high confidence. This can be seen from the acquisition of empirical meanings of 87.88% and the hypothetical average of 72.5%. The subjects of this study are students who have high self-concept in the subject of this study, among others, one of which is influenced by environmental factors. This is supported by Mancini (2003) saying that environmental factors can also influence a person in managing individual time, the environment can be used as an individual control in motivating themselves and managing study time.

2. From the perspective of Fighting Power, the IKIP-PGRI Pontianak students completed their initial assignments and their final assignments were relatively low. This can be seen from the results of the Fighting Motivation scale categorization of students completing their studies. It is known that there are 26 students (26%) showing moderate, 56 students (56%) showing high, and 18 students (18%) Fighting Motivation. high. This can be seen from the acquisition of empirical mean of 88.06 and the hypothetical average of 72.5. This shows that the object / subject in this study is able to make decisions, believe and believe in those who are presented themselves, then also be able to express disagreement with not hurting others but also not ignore the rights and opinions of other members. This study also conducted an analysis to find out how much effective contribution of independent variables in influencing dependent variables. The results of the analysis show that the determinant coefficient ($r^2 = 0.321$). This shows that the

concept of self-confidence concept contributes an effective contribution of 32.1% in influencing assertive behavior, while the remaining 67.9% is influenced by other variables, namely gender, personality type, level of intelligence, age, and self-esteem (Rakos, 1991).

3. The results of this study indicate that there is a significant positive relationship between Fighting Motivation students complete the study, but there are some limitations in this study, including: a) In filling the scale, it is possible for subjects to tend to cover up their true information. b) The measuring instrument used only uses a scale, so it has not been able to capture other aspects that influence assertive behavior in depth, both psychological symptoms, physiologies, and invisible behavior. c) Ideally giving instructions is done by the researchers themselves so that the subjects better understand and give results that represent the actual conditions, but in this study the subjects read themselves the instructions written on the scale and not read by researchers, so there might be differences in understanding the concept of reading the message content be delivered. The number of students who postpone completing their assignments is the final task (writing a thesis) after completing the KKM and integrated PPL in their respective places of origin, so that the study period that should be completed 3.5 to 4 years stretches to 5 to 6 years or even longer.

4. Motivation and Spirit of Learning Pontianak IKIP-PGRI students in following the lecture process are "sufficient". This can be seen from the fact that there are still many students who are not on time attending classes, the lack of students asking questions in following the lecture process and the lack of students expressing their opinions both in presentations and in group discussions.

5. The learning achievements of the Pontianak IKIP-PGRI students have not been maximized. This can be seen from various factors such as internal factors and student external factors, the low value of training results in solving daily recovery questions including learning independence and lecturer and student interaction, student interaction with employees (employees) and contact and communication between lecturers and students on campus there has not been a maximu

6. The positive relationship of this study indicates that the higher the self-confidence, the higher the Fighting Power and Student Motivation, and vice versa, the lower the student's self-confidence, the lower the Fighting Power and Motivation for the students to complete their studies.

7. The results of this study indicate that there is a significant positive relationship between Fighting Motivation students complete the study, but there are some limitations in this study, including: a) In filling the scale, it is possible for subjects to tend to cover up their true information. b) The measuring instrument used only uses a scale, so it has not been able to capture other aspects that influence assertive behavior in depth, both psychological symptoms, physiologies, and invisible behavior. c) Ideally giving instructions is done by the researchers themselves so that the subjects better understand and give results that represent the actual conditions, but in this study the subjects read themselves the instructions written on the scale and not

read by researchers, so there might be differences in understanding the concept of reading the message content be delivered.

According to Stoltz (2000) internal factors that most influence one's fighting power are beliefs. This is because there is hope in belief. Almost all students have confidence that they are able to finish their studies well and are able to continue their education to a higher level. The most influential external factor in fighting power is the willingness and character of one person. Students have motivations that tend to be the same. Most of the motivation possessed by students is from their own desire to go to college and driven by the hope of parents who want their children to go to high school, especially educational institutions that are insightful Educational Institution Education Institutions (LPTK). Besides that, it was also driven by the students' desire to make their parents happy.

A. Description of Discussion of Research Results

Based on the Confidence of Fighting Power and Motivation of Learning of IKIP-PGRI Pontianak Students in completing the Study "Odd Semester of Academic Year 2017/2018. Based on the results of the survey, observations supported by both quantitative and qualitative data analysis can be described as follows:

1. Self-confidence in learning independence

Independence is the level of development of a person where he is able to stand alone and rely on his own ability to carry out various activities and resolve various problems faced (Eddy-Wibwo 1992: 69) Whereas independence According to Masrun (1986: 8) is an attitude that allows someone to act free, do something on their own and for their own needs without help from others, or think and act original / creative, and full of initiative, able to influence the environment, have confidence and gain satisfaction from their business.

Psychological and mentalist independence is the condition of someone who in his life is able to decide and do something without help from others. Such ability is only possible if someone has the ability to think carefully about something he does or decides, both in terms of benefits or benefits, as well as negative aspects and losses that will be experienced (Hasan Basri, 2000: 53). Every activity carried out by someone in order to succeed according to his desires requires strong independence. While the understanding of learning is defined as a business process carried out by individuals to obtain a change of behavior that is new as a whole, as a result of the experience of the individual itself in the interaction of individuals with their environment. Learning according to Slavin in Catharina Tri Anni (2004) is a process of acquiring abilities that come from experience. According to Gagne in Catharina Tri Anni (2004), Learning is a system in which there are various elements that are interrelated so as to produce behavioral changes.

Thus it can be interpreted that Self-confidence in Learning Independence is not dependent on others, students are required to have their own activeness and initiative in learning, acting, national and state (Abu Ahmadi and Nur Uhbiyati, 1990: 13). Learning Independence according to Haris Mujiman (2005: 1) is an active learning activity,

which is driven by intentions or motives to master a competency to overcome a problem, and is built up with the knowledge or competence possessed. Determination of competencies as learning goals, and how to achieve them both the determination of study time, the place to learn rhythm learning, the tempo of learning, how to learn, and learning evaluation carried out by the students themselves. Independence of Learning here is interpreted as an effort for students to carry out learning activities based on their intention to master a particular competency. Understanding Independence Learning students according to Stephen Brookfield (2000: 130-133) is self-awareness, self-driven, learning ability to achieve its goals. Independence of Student Learning according to Merriam & Caffarella (1999), is a process where individuals take the initiative in planning, implementing and evaluating their learning systems. According to Grieve (2003) Learning Independence is a personal attribute, a person's psychological readiness in controlling or being responsible in the learning process.

Student learning independence according to Knowles (1989) is a learning process where each student or individual can take the initiative, with or without the help of others, in diagnosing learning needs, formulating learning goals, identifying learning resources (both in the form of people and materials), choosing and implementing Learning strategies that are appropriate for him, and evaluating his learning outcomes. Similar opinions were expressed by Kozma, Belle and Williams (1978), who stated that independent learning is a form of learning that provides opportunities for students to determine: learning objectives, learning resources and learning activities according to their own needs. Whereas according to Mocker & Spear (1984) Independence of Learning is a process where students control their own learning process and the purpose of the learning.

2. Student Learning Achievement.

Learning achievement is the result of one's achievement in the fields of knowledge, skills, and behavior as indicated by the numbers given by the instructor. There are many factors that influence student achievement. These factors are classified into internal factors, namely factors originating from within the student and external factors, namely factors originating from outside the student. Achievement "is the result of the emphasis of potential skills or possessed by a person whether it is a person's capacity or ability, while that can be seen from his behavior, including knowledge, ways of thinking, and skills possessed by someone" (Sukmadinata 2003: 101).

According to Shah (2008: 150) Learning Achievement is "changes in behavior that are considered important and are expected to reflect changes that occur as learning outcomes, both dimensions of creativity and taste and according to Sukmadinata (2003: 101) Achievement is "the result of the emphasis of skill- potential skills or possessions of a person whether it is a person's capacity or ability, while it can be seen from his behavior, including knowledge, ways of thinking, and skills possessed by someone ". According to the opinion of Shah (2008: 150) Learning Achievement is " changes in behavior which is considered important and can

reflect changes that occur as a result of learning, both in the dimensions of creativity and taste and dimensions of work ".

It can be concluded that learning achievement is a process of student learning activities to obtain a knowledge that all of them can be measured by value. These values are included in the KHS (study card). So that the value can be seen to what extent the learning process of each student in improving entrepreneurial learning achievement.

From the above understanding it can be concluded that learning achievement in a process of student learning activities to obtain a knowledge that all of them can be measured by value. These values are included in the KHS (study card). So that the value can be seen to what extent the learning process of each student in improving entrepreneurial learning achievement.

3. Student Learning Motivation and Spirit.

Motivation is a will that causes someone to do an action to achieve a certain goal. Motivation comes from the word motif which means "impulse" or stimulation or "driving force" that is in a person. According to Weiner (1990) cited Elliot et al. (2000), motivation is defined as an internal condition that arouses us to act, encourages us to achieve certain goals, and keeps us interested in certain activities. According to Uno (2007), motivation can be interpreted as an internal and external drive in a person that is indicated by; passion and interest; encouragement and need; hopes and ideals; appreciation and respect. Motivation is something that makes a person act (Sargent, quoted by Howard, 1999) stating that motivation is the impact of one's interaction with the situation they face (Siagian, 2004).

Motivation is a process that explains the intensity, direction, and perseverance of an individual to achieve his goals. The three main elements in this definition include intensity, direction, and perseverance. Based on the hierarchy theory of Abraham Maslow's needs, X theory and Douglas McGregor's Y theory and contemporary motivational theory, the meaning of motivation is the 'reason' that underlies an action carried out by an individual. Someone said to have high motivation can be interpreted the person has a very strong reason to achieve what he wants by doing his current job. Unlike motivation in the sense that develops in society which is often equated with 'enthusiasm', as in the example in the conversation "I want my child to be highly motivated". This statement can be interpreted as parents who want their children to have a high learning spirit. So, it needs to be understood that there are differences in the use of the term motivation in society. There are those who interpret motivation as an excuse, and some interpret motivation as spirit.

In the relationship between motivation and intensity, intensity is related to how actively a person tries, but high intensity does not produce satisfactory work performance unless the effort is associated with a direction that benefits the organization. Instead the last element, perseverance, is a measure of how long a person can maintain his business.

Motivation comes from the Latin "movere", which means to move. According to Weiner (1990) motivation is defined as an internal condition that arouses us to act, encourages us to achieve certain goals, and keeps us interested in certain

activities. According to Uno (2007), motivation can be interpreted as an internal and external drive in a person that is indicated by; passion and interest; encouragement and need; hopes and ideals; appreciation and respect. While Imron (1966) explained that motivation comes from English "motivation" which means encouraging or reasoning to do an activity to reach a goal. From a number of understanding of the experts above, it can be concluded that motivation is a reason that encourages someone to do; complete; stop; etc., an activity to achieve certain desired goals of the motivation.

4. *Self-confidence and student learning independence.*

According to Hygiene (2014) Self Confidence is a relatively fixed assessment of oneself, regarding abilities, talents, leadership, initiative, and other traits, as well as conditions that characterize human feelings (Iswidharmanjaya & Enterprise, 2014: 20-21). Self-confidence is a positive attitude of an individual who enables him to develop positive judgments, both on himself and on the environment or situation he faces (Fatimah, 2010: 149). People who are confident are better able to adjust to the new environment, people who are confident will be more easily mingled and adapted than those who are not confident. Because people who have confidence have a strong grip, are able to develop motivation, they are also able to learn and work hard to progress, as well as full of confidence in the role they live (Iswidharmanjaya & Enterprise, 2014: 40-41). Self-confidence is a person's mental or psychological condition, where an individual can evaluate the whole of him so as to give a strong belief in his ability to take action in achieving various goals in his life (Setiawan, 2014: 14). Self-confidence starts from yourself and supports from others. Self-confidence can change someone who is usually not brave in facing something, with a self-confidence someone becomes more confident and able to deal with or do something.

5. *Characteristics of Self-Confidence.*

There are 7 characteristics of individuals who have a proportional sense of self-confidence, among others, as follows (Fatimah, 2010: 149-150): Believing in competence / self-ability, so as not to require praise, recognition, acceptance, or respect for others. Not encouraged to show conformist attitudes accepted by other people or groups as follows.

- a. Dare to accept the refusal of others to dare to be themselves.
- b. Have good self-control (not mood and emotional stability).
- c. Having an internal Locus of Control (looking at success or failure, depending on self-effort and not easily giving up on fate or circumstances and not relying on other people's help).
- d. Making a positive view of yourself, others, and situations outside of him.
- e. Have a realistic expectation of oneself, so that when that expectation is realized, he is still able to see the positive side of himself and the situation that occurs.

6. *Characteristics of Self-Confidence*

The characteristics of someone who has a sense of self confidence include several parts as follows (Iswidharmanjaya & Enterprise, 2014: 48-49).

- a. Responsible for decisions that have been made by themselves,
- b. Easily adjust to the new environment.
- c. The life handle is strong enough, able to develop motivation,
- d. Want to work hard to make progress,
- e. Convinced of the role faced,
- f. Dare to act and take every opportunity he faces,
- g. Accept yourself realistically,
- h. Respect yourself positively, without thinking negatively, confident that he is capable,
- i. Confident of your own abilities and not affected by others, and
- j. Optimistic, calm in facing challenges and not easily anxious.

7. *Fighting Power of Students to complete their lecture assignments.*

According to Stoltz (2000), a person's ability to overcome difficulties and survive in overcoming these difficulties is called fighting power. Stoltz reveals that, when a person is faced with life's challenges and difficulties, most people will stop trying before they cross their limits.

With regard to the processing of data above Stoltz (2000) revealed that the fighting power of a person (IKIP-PGRI Pontianak students) is influenced by several things such as competitiveness, productivity, creativity, motivation, dare to take risks and make improvements, perseverance and learning, and be able to face change and optimism. A student with high fighting ability never lets obstacles prevent him from achieving success. They (students) are also quite able to withstand challenges and make use of some of their potential. In addition, a student with high fighting ability is easily recovered from adversity and continues to face the next challenge. Whereas a student who has a low fighting ability tends to use less of his potential and tends to make things more difficult because he feels powerless (Aziz, 2012).

Based on the problems mentioned above, it appears that the difficulties experienced by students are related to self-adjustment. This causes difficulties in communicating to build relationships with others and achieve. Phoolka and Navjot (2012), asserted that a student's fighting power is a predictor of success in facing difficulties, namely about how a student behaves and controls a difficult situation in his life and is optimistic that the difficulties in time will end too. Fighting power is the intelligence that a student has to overcome his difficulties in order to survive. The fighting power of a student in this context is measured by seeing his ability to overcome his life problems. There are no people who succeed without struggle (Agustian, 2001). Stoltz (2000), states that fighting power has the following aspects:

- a. Control. It is a situation where a person is able to empower difficult situations, control, control responses and the ability to not be discouraged in facing difficult situations. Based on the results of data analysis, Pontianak

IKIP-PGRI students were mostly (79%) able to overcome, respond and recognize themselves in difficult situations.

b. **Origin and Ownership (Origin and recognition).** Origin is the ability to see oneself as the main cause of the difficulties faced, not to regret any difficulties and to be able to assess the behavior done to correct his mistakes. Ownership is the ability to be responsible and recognize the consequences of difficulties. Based on the results of the survey, observation and data analysis, Pontianak IKIP-PGRI students 77% did not regret any difficulties and be able to assess the behavior he is doing and be ready to correct his mistakes. Reach

c. It is a person's ability to limit every difficulty so that it does not affect other activities and aspects of life and thinks that difficulties are not a disaster in his life. Based on the results of data processing, surveys, observation and data analysis, 79% of IKIP-PGRI Pontianak students think that difficulties are not a disaster in life in completing their studies.

d. **Durability.** About how long the difficulties and causes will take place. Someone who sees ability as the cause of failure tends to be less able to survive compared to someone who associates failure with the effort made. According to Stoltz (2000), the factors that influence fighting power include Internal factors

1. **Genetics** is a congenital factor that underlies a person's behavior, as well as the mood and level of anxiety a person has.

2. **Education** can affect intelligence, the formation of healthy habits, character development, skills of desire and performance produced.

3. **Confidence** is a very important factor in achieving success. This belief is related to expectations, actions, morality, contributions and how one treats others.

Stoltz (2000) adds factors that influence one's fighting power as follows.

1. **Competitiveness.** Competitiveness is closely related to hope, agility, and tenacity determined by the way a person faces challenges and failures in his life. Satterfield and Seligman (in Stoltz, 2000) argue that people who respond optimistically to difficulties will be more aggressive and take more risks, while people who respond to difficulties pessimistically will be passive and more careful.

2. **Productivity.** People who respond to difficulties well will look more productive compared to people who do not respond well.

3. **Creativity.** Creativity requires ability to overcome difficulties caused by uncertain situations. Someone who is unable to face difficulties becomes unable to be creative.

4. **Motivation.** A person who has high fighting ability is considered to have high motivation as well.

5. **Taking a resume.** A person who has a high fighting ability tends to take more risks than those who have a low fighting ability.

6. **Improvement.** A person who has high fighting power will always make improvements to be better. Meanwhile, someone who has a low fighting ability will be worse because he is unable to make improvements.

7. **Perseverance.** Perseverance is the ability to constantly try, even if faced with difficulties and failures.

8. **Learning.** Dweck in (Stoltz, 2000) reveals that someone with a pessimistic response to difficulties will not learn much and perform well compared to someone who has an optimistic response.

9. **Embracing change.** The ability to deal with uncertainties and difficulties that are always changing becomes increasingly important for survival. A person who responds to difficulties well will be able to embrace change by turning difficulties into opportunities.

10. **Tenacity, stress, pressure and setbacks.** Tenacity is needed to deal with the possibility of rising again. A person should have a flexible and resilient emotional and physical ability to recover from disappointment and fatigue. People who have hardiness will remain resilient in the face of difficulties. Whereas people who do not have hardiness will tend to be weak due to difficult situations.

Based on the results of data processing, surveys, observations and data analysis, it is known that the majority of Pontianak IKIP-PGRI students have hardiness that will remain resilient in the face of difficulties in completing their studies.

Next Stoltz (2000) divides fighting power into three levels as follows:

1. **Quitters (Stop)** It is a person who chooses to avoid his obligations, retreat and stop. People of this type reject opportunities and leave behind a lot of things life offers. Quitters lives a life that isn't too pleasant. Based on data analysis, surveys, and observations, it is known that there are still Pontianak IKIP-PGRI students who choose to leave, avoid their obligations, retreat and stop in the face of difficulties living as students.

2. **Campers (Camping).** Is a type that is easy to give up and easily satisfied and tends to not want to develop themselves. Campers are the type of people who get tired easily in climbing and tend to find a comfortable place. Campers tend to let go of opportunities that can actually be achieved by directing energy and resources properly. Based on data analysis, surveys, and observations, it is known that there are still Pontianak IKIP-PGRI students who are easy to give up and easily feel satisfied and tend not to develop themselves in the face of difficulties.

3. **Climbers (Climber)** A thinker who always thinks of possibilities and does not allow other obstacles to hinder his ascent. Climbers believe that everything can happen even if people are negative to him and even doubt it. Climbers have high enthusiasm and are able to motivate themselves to struggle to get the best from life. Climbers establish a close bond of friendship and dedicate themselves to lifelong learning and continuous improvement. Based on data analysis, surveys, and observations, it is known that most IKIP-PGRI Pontianak students have high enthusiasm and are able to motivate themselves to struggle to get the best out of their lives as students studying.

IV. CONCLUSION

A. Conclusion

Based on the results of the survey, observation and results of data analysis in this study, it can be concluded in general

that: "Fighting Confidence and Achievement Motivation of IKIP-PGRI Pontianak Students Complete Odd Semester 2017/2018 Study)." Categorized as Enough "Specifically according with the effect of the study in this study can be stated as follows:

1. Self-confidence and independence of learning for Pontianak IKIP-PGRI students in completing their studies on time is relatively low. This can be seen from more than half of the students saying the study period between 4.5 to 5 years even has more and less courageous students express opinions in lecture events and institutional group discussions.
2. The fighting spirit of Pontianak IKIP-PGRI students completes their initial assignments and their final assignments are relatively low. This can be seen from the large number of students who postpone completing their tasks in the final assignment (writing a thesis) after completing the KKM and integrated PPL in their respective places of origin, so that the study period which should be completed 3.5 to 4 years stretch be 5 to 6 years or even longer.
3. Motivation and Spirit of Learning Pontianak IKIP-PGRI students in following the lecture process are "sufficient". This can be seen from the fact that there are still many students who are not on time attending classes, the lack of students asking questions in following the lecture process and the lack of students expressing their opinions both in presentations and in group discussions.
4. The learning achievement of Pontianak IKIP-PGRI students is not maximal (enough). This can be seen from various factors such as internal factors and student external factors, the low value of training results in solving daily recovery questions including learning independence and lecturer and student interaction, student interaction with employees (employees) and contact and communication between lecturers and students on campus there has not been a maximum.

B. Suggestions

1. The IKIP-PGRI Pontianak institution through the Academic Field and each Study Program are expected to be able to help students foster self-confidence and independence of student learning through strengthening self-confidence, by providing appropriate treatments, using learning methods that can encourage more active students and assertive and provide assertive training to improve students' assertiveness through the intensity of increasing coaching by Academic Advisors (PA) so that they have high self-confidence and can complete their studies on time
2. The IKIP-PGRI Pontianak institution through lecturer lecturers of each Study Program needs to generate, improve, and maintain a spirit of continuous student learning, through activities that stimulate all achievements so as to create competitiveness both within the Study Program and within the scope of IKIP to creating competitiveness in completing final assignments (studies) in each Study Program, Faculty and in the IKIP Environment itself.
3. In carrying out teaching assignments subject lecturers need to use varied methods and use media that are

able to generate competitiveness in accordance with the learning objectives. Lecturers need to know each student who is taught personally so that they can provide guidance and direction in accordance with the growth of student personality.

4. For further researchers, if there are other researchers who are interested in continuing research on Confidence Fighting Power and Learning Motivation, they should associate it with other variables besides self-concept such as gender, personality type, intelligence level, age, self-esteem and the place of origin of students.
5. In taking the subject / object of research it is recommended not only in the campus area, but can be more extensive and multiplied so that students can learn the behavior of Fighting Confidence and Student Motivation in completing the Study ".

REFERENCES

- Agusta, Y. N. (2015). Hubungan antara Orientasi Masa Depan dan Daya Juang terhadap Kesiapan Kerja pada Mahasiswa Tingkat Akhir Fakultas Ilmu Sosial dan Ilmu Politik di Universitas Mulawarman. *eJournal Psikologi*. Vol. 3 No. 1 (369-381).
- Agustian, A. G. (2001). *Rahasia Sukses Membangun Kecerdasan Emosi dan Spiritual ESQ : Berdasarkan 6 Rukun Iman dan 5 Rukun Islam*. Jakarta
- Akbar, Y. R., Supriyono, Y. & Ramli, A. H. (2014) Peran Emotional Quotient dan Adversity Quotient Terhadap Kecemasan Menghadapi Dunia Kerja Pada Siswa SMK. (Research). Retrieved from <http://psikologi.ub.ac.id/wp.content/uploads/2014/09/Jurnal.pdf>
- Anggoro, Toha, M dan Andriani Durri (2007) *Metode Penelitian*. Jakarta: Universitas Terbuka.
- Arikunto, Suharsimi. (2006). *Prosedur Penelitian Suatu Pendekatan praktik*. Jakarta : Rineka Cipta.
- Arikunto S, (1992) *Dasar-dasar Evaluasi Pendidikan*, Penerbit Bumi Aksara, Jakarta.
- Aprianti Yofita Rahayu. (2013). *Menumbuhkan Kepercayaan Diri Melalui Kegiatan Berbicara*. Jakarta Barat : PT Indeks.
- Azhari, Akyas. (2004). *Psikologi umum dan perkembangan*. Jakarta Selatan : PT Mizan Publika
- Azwar, Saifuddin. (2003). *Sikap Manusia Teori dan Pengukurannya*. Yogyakarta: Pustaka Pelajar Offset.
- Azwar, S. (2005). *Tes prestasi dan pengukuran prestasi belajar*. Yogyakarta: Pustaka pelajar Akbar
- Beke, Agus Dairo.(2008). Pengaruh Motivasi Berprestasi Mahasiswa, Persepsi Kompetensi Dosen, dan Sikap Mahasiswa terhadap Hasil Belajar Mata Kuliah Manajemen Sumber Daya Manusia. *Bina Widya*. Volume 19 (3); 167-175.
- Bennu, S. (2012) Adversity Quotient: Kajian Kemungkinan Pengintegrasian dalam Pembelajaran Matematika. *Jurnal AKSIOMA*, 01 (01), 55 – 62.
- Berzonsky, M.D. (1981) *Adolescent Development*. New York: MacMilan Publishing
- Byrne, M.and Flood, B.(2008). "Examining the relationships among background variables and academic performance of first year accounting students at an Irish University". *Journal of Accounting Education*, Volume 26(4); 202-212.
- Burns, R. 1996. *Konsep Diri. Teori, Pengukuran, Perkembangan dan Perilaku*. Jakarta : Gramedia
- Canivel, L.D. (2010) *Principals' Adversity Quotient: Styles, Performance And Practice*. Disertation, The faculty of the College Education University of Philippines, Quezon City.
- Calboun dan Acocella.2010. *Pembentukan Kepribadian Anak*. Jakarta : PT Gramedia
- Cawood, D. 1997. *Manajer yang Asertif :Terampil Mengelola Karyawan Efektif dalam Komunikasi (Terjemahan)*. Jakarta : Gramedia Pustaka Utama
- Chin, PL. & Hung, ML. (2013) Psychological Contract Breach And Turnover Intention The Moderating Roles of Adversity Quotient And Gender. *Social Behavior and Personality Journal*. 41 (5), 843-860. <http://dx.doi.org/10.2224/sbp>. Creswell, John W. (2010)

- Darmadi Hamid (2012) "Kepercayaan Diri Daya Juang dan Motivasi Berprestasi Mahasiswa Menyelesaikan Studi (Hasil Penelitian)
- Darmadi Hamid (2014) Metode Penelitian Pendidikan, Dasar Konsep dan Implementasi Bandung, Alfabeta Darmawan, I. (2009). Kiat Jitu Taklukkan Psikotes. Yogyakarta : Pustaka Widyatama Desain Pendekatan Kualitatif, Kuantitatif, dan Mixed. Yogyakarta : Pustaka Pelajar
- David R. Krathwohl, (1993). *Method of Education and Social Sciences Research, an Integrated Approach*. Longman Publishing Group.
- Dunkin, Michael J. and Bruce J. Biddle. (1974). *The Study of Teaching*. USA: Holy, Rinehart and Winston, Inc.
- Djamarah, S.B. (2000) *Guru dan Anak Didik Dalam Interaksi Edukatif*. Jakarta: PT. Rineka Cipta.
- Elida Prayitno. 1989. *Motivasi Dalam Belajar*. Jakarta: Departemen Pendidikan Dan Kebudayaan.
- Fitrianiingsih. 2012. *Hubungan Antara Konsep Diri dan Motivasi Belajar dengan Kecenderungan Perilaku Membolos*. Thesis (tidak diterbitkan). Surakarta : UMS
- Fitri R. *Hubungan Antara Konsep Diri dengan Intensi Menyontek pada Mahasiswa*. Thesis (tidak diterbitkan). Surakarta : UMS
- Gall, Meredith D, Joyce P. Gall & Walter R. Borg. 2007. *Educational Research*. USA: Pearson Education Inc.
- Gay, L.R. (1983). *Educational Research Competencies for Analysis & Application*. 2nd Edition. Ohio: A Bell & Howell Company.
- Ghony, M. D., & Fauzan A. (2012). *Metode Penelitian Kualitatif*. Yogyakarta : Ar-Ruzz Media.
- Hadeli, (2006). *Metode Penelitian Kependidikan*. Penerbit: Quantum Teaching. Didistribusikan PT. Ciputat Press Jakarta Herawaty. Y. & Ratna W. (2013). *Hubungan antara Keberfungsian Keluarga dan Daya Juang dengan Belajar Berdasar Regulasi Diri pada Remaja*. *Jurnal Psikologi*. Vol. 9 No. 2 (138-147)
- Hakim. T. (2002). *Mengatasi Rasa Tidak Percaya Diri*, Jakarta: Purwa Suara.
- Hamzah B. Uno. (2008). *Teori Motivasi Dan Pengukurannya*. Jakarta: PT. Bumi Persada.
- Hopkins, David. (1993) *A Teacher's Guide to Classroom Research*. Philadelphia: Open University Press.
- Huijoun, Z. (2009) *The Adversity Quotient and Academic Performance Among College Students AT ST. Joseph's College Quezon City*. Thesis. Faculty of The Departments of Arts And Sciences.
- Iswanti, Yustiana Wiwiek. (2002). *Pengaruh Motivasi Berprestasi dan Peran Orang Tua Dengan Prestasi Belajar Siswa SMU Tarakanita I*. Tidak Diterbitkan
- James W. Popham dan Kenneth A. Siratnik. (1973). *Education Statistics: use and interpretation*, Harper and publishel, New York.
- Jarolimek, John. (1967) *Social Studies in Elementary Education*. 5th. edition. NY: McMillan Co. Inc.
- Jacob Utomo. (1980) *Kemandirian Belajar Siswa Perlu Ditingkatkan*. Jakarta: Bumi Aksara.
- John W. Best, (1982) *Metodologi Penelitian Pendidikan*, penerjemah Sanapiah Faisal dan Mulyadi Guntur Waseso, Usaha Nasional,
- Iskandar (2013) *Metodologi Penelitian Pendidikan dan Social*, Cetakan kelima, Ciputat Mega Mall. Jakarta
- Kirlinger, Fred N. (1973) *Foundations of Behavioral Research*. San Fransisco: Holt, Rinehart and Winston. Inc., Kruck, S.E dan Diane Lending. (2003). *Predicting Academic Performance in an Introductory College-Level IS Course*. *Information Technology, Learning, and Performance Journal*. Volume 21(2); 9-15
- Lestari, Puji. dan Irianing Kitch, S. L. (2002) *Claiming success: From adversity to responsibility in women's studies*. *NWSA Journal*; Spring, 14 (1), 160 – 181 ProQuest.
- Nikam, V. B., & Megha M. U. (2013). *Adversity Quotient and Defense Mechanism of Secondary School Students*. *Universal Journal of Educational Research*. Vol. 1 No. 4 (303-308).
- Nashori (2007) *Pelatihan Adversity Intellegence untuk Meningkatkan Kebermaknaan Hidup Remaja Panti Asuhan*. *Jurnal Psikologi* No.23 Thn. XII.
- Phoolka, E.R.S., & Navjot K. (2012). *Adversity Quotient : A New Paradigm to Explore*. *International Journal of Contemporary Business Studies*. Vol. 3 No. 4 (67-78).
- Poerwandari, K. (2011). *Pendekatan Kualitatif Untuk Penelitian Perilaku Manusia*. Jakarta : LPSP3 UI.
- Pusat Teknologi Informasi dan Pangkalan Data (PTIPD) Universitas Islam Negeri (UIN) Sunan Kalijaga.
- Rakos, R.F. (1991). *Assertive Behavior Theory, Research and Training*. London : Routledge
- Rees, S & Graham, R.S. (1991). *Assertion training: how to be who you really are. (Strategies for mental health)*. New York A Tavistock/Routledge Publication.
- Republik Indonesia (RI). (2003). *Undang -Undang RI No. 20 Tahun 2003 Tentang Sistem Pendidikan Nasional*. Jakarta : CV. Eka Jaya.
- Siregar, M., dkk. (2008). *Pedoman Pengembangan Mahasiswa Menjadi Pembelajar yang Sukses : Strategi Kunci Pengembangan Jati Diri dan Sukses Studi*. Yogyakarta : UIN Sunan Kalijaga.
- Stoltz, Paul.G. (2000). *Faktor Paling Penting dalam Meraih Sukses : Adversity Quotient Mengubah Hambatan Menjadi Peluang*. Jakarta : PT. Grasindo.
- Stoltz, Paul G. 2000. *Adversity Quotient (Mengubah Hambatan Menjadi Peluang)* terjemahan oleh T Hermaya. Jakarta : PT Gramedia Widiasarana Indonesia.
- Sulastri, T. (2007) *Hubungan Motivasi Berprestasi dan Disiplin dengan Kinerja Dosen*. *Jurnal Optimal*, 1 (1), 13 – 21.
- Sugiyono. (2011). *Metode Penelitian Kuantitatif, Kualitatif dan R & D*. Bandung : Alfabeta.
- Susanti, N. (2013). *Hubungan antara -Dukungan Sosial dan Daya Juang dengan Orientasi Wirausaha pada Program Profesi Apoteker Universitas Ahmad Dahlan Yogyakarta*. *Empathy Jurnal Fakultas Psikologi*. Vol. 2 No. 1.
- Sudjana, Nana. (2003). *Penilaian Hasil Proses Belajar Mengajar*. Bandung: PT. Remaja Rosdakarya.
- Sukmadinata, Nana Syaodih. (2003). *Landasan Psikologi Proses Pendidikan*. Bandung : Remaja Rosdakarya .
- Syah, Muhibbin. (2008). *Psikologi Pendidikan dengan Pendekatan Baru*. Bandung : PT Remaja Rosdakarya.
- Setyaningrum, R. (2013). *Hubungan Antara Konsep Diri Dengan Asertivitas Pada Siswa Kelas XI Di SMA Negeri 1 Kota Mungkid Magelang*.
- Sutrisno Hadi. (1987) *Analisis Regresi*. Yogyakarta: Yayasan Penerbitan Fakultas Psikologi U.G.M.,
- Suparlinah. (2010). *Analisis Faktor-faktor yang Mempengaruhi Prestasi Akademik Mahasiswa pada Mata Kuliah Pengantar Akuntansi*. *Jurnal Manajemen dan Akuntansi*, Volume 11(2); 144-152
- Slameto. (2003). *Belajar dan Faktor-Faktor yang Mempengaruhinya*. Jakarta : Rineka Cipta
- Weiner, B. (1986) *Attribution Theory and Attribution Therapy: Some Theoretical Observation and Suggestions*. *British Journal of Clinical Psychology*, 27, 93-104.
- Y. R., Supriyono, Y. & Ramli, A.H. (2014) *Peran Emotional Quotient dan Adversity Quotient Terhadap Kecemasan Menghadapi Dunia Kerja Pada Siswa SMK*.
- Zainuddin. (2010). *Pentingnya Adversity Quotient Dalam Meraih Prestasi Belajar*, Pontianak: Universitas Tanjungpura. *Jurnal Guru Membangun*. 26 (2). 2011. jurnal.untan.ac.id.

The Role of Zakat in Treatment Victims of Natural Disasters -Maqashid Review-

Harun Alrasyid, Rafika Nur Laili

Faculty of Economic and Business Universitas Islam Malang

Malang, Indonesia

harunalrasyid@unisma.ac.id

Abstract— Zakat is a means of social solidarity established by Islamic law to prevent anyone from falling into the cycle of poverty, whether for prevention or treatment. The study aimed to know the possibility of improving the role of Zakat as a solution to the government in responding needs of the victims of natural disasters in accordance with Maqasid Sharia goals. We often face funding problems during disaster management, reconstruction and rehabilitation. This study initially dealt with geographical situation of Indonesia, which is vulnerable to any natural disasters, and then discussed the jurisprudence of scholars on the ruling on issues related to Zakat payment for victims of natural disasters in addition to the amount since they are not included in the eight categories mentioned in the Koranic text. The study concluded that Zakat can be used as a preventive tool to prevent natural disasters by applying it as one of the obligations for society and state income and then treating its victims during alleviation, rehabilitation and reconstruction phase, In line with the purposes of Koranic texts related to zakat, by allocating parts of Fuqara, Masakiin, Muallaf, Gharimin and Ibnu Sabiil.

Keywords— Zakat, Maqashid, Natural Disaster

ملخ ص- الزكاة وسيلة التضامن والتكافل الاجتماعي تفرضها الشريعة الإسلامية لمنع أي شخص من الوقوع في دائرة الفقر، سواء على سبيل الوقاية أو العلاج. تهدف هذه الدراسة إلى معرفة إمكانية تحسين دور الزكاة كحل للحكومة في تلبية احتياجات مصابي الكوارث الطبيعية وفقاً لأهداف مقاصد الشريعة، لأننا نواجه غالباً مشكلات التمويل أثناء إدارة الكوارث وإعادة التأهيل والإعمار. وتناولت الدراسة في البداية توضيح الوضع الجغرافي لإندونيسيا الذي معرض لأي كوارث طبيعية، ثم ناقشت الآراء الفقهية حول مسألة صرف الأموال الزكوية لمصابي الكوارث الطبيعية بالإضافة إلى المبلغ المدفوع إليهم لعدم إدراجهم في الأصناف الثمانية المذكورة في النص القرآني. وخلصت الدراسة إلى أن الزكاة يمكن استخدامها كأداة وقائية لمنع الكوارث الطبيعية من خلال تطبيقها كأحد الآليات الزمات من المجتمع ودخل الدولة ومن ثم معالجة مصابيها أثناء مرحلة التخفيف وإعادة التأهيل والإعمار، وذلك تشبهاً مع أغراض النصوص القرآنية المتعلقة بالزكاة، من خلال تخصيص أسهم الفقراء أو المساكين أو المؤلفين قلوبهم أو الغارمين أو ابن السبيل.

الكلمات المفتاحية: الزكاة، مقاصد، الكوارث الطبيعية

مقدمة

تعد الكوارث الطبيعية من أخطر أنواع الكوارث التي تتعرض لها الكرة الأرضية مما يسبب إلى خسائر كبيرة في الأرواح والممتلكات، وقد يمتد تأثيرها إلى الإضرار بالاقتصاد القومي والاجتماعي للدولة ألواح 3. ومن الناحية الجيولوجية، تقع جمهورية إندونيسيا بين تكتونية، وهي لوحة أوارسيا ولوحة المحيط الهادئ ولوحة الهندي الأستارلي. وقد تسبب هذا في أن تكون إندونيسيا معرضة للكوارث الطبيعية، خاصة من زلازل وتسونامي وانفجارات بركانية وأنواع أخرى من الكوارث الجيولوجية. وينتشر تهديد مخاطر الزلازل في جميع أنحاء الأرخيبيل الإندونيسي، سواء على نطاق صغير أو على نطاق مدمر. وأظهرت العديد من الدراسات أن جزر كاليمانتان الغربية والوسطى والجنوبية هي لم يتم العثور عليها كمصدر للزلازل، ولكن هذا لا يعني أن هذه المناطق خالية من التهديدات لأن لها من المحتمل أن تتأثر الصدمات من مصدر الزلزال في بحر جاوا ومضيق (BNPB, 2017) .

(أن خلال عام BNPB ووفق تقرير الوكالة الوطنية لإدارة الكوارث)

شخص 4814 في إندونيسيا تسببت إلى وفاة 2573 وقعت 2018 شخص وتضرر 10239533 شخص ونشر 21083 وإصابة 1736 مرفق العبادة و857 مرفق الصحة و106 منزل و574838 مرفق التعليم⁶⁶ وتتسبب المشاكل دائماً عند حدوث الكوارث الطبيعية، مثل كيفية التغلب على آثار الكوارث وتقليلها إلى الحد الأدنى وإعادة التأهيل والإعمار ما بعد الكوارث.

وتعتبر الزكاة واحدة من الركائز الخمس الرئيسية للإسلام، وهي أداة إلهية أعدها الله لعباده ليتخذوها وسيلة للتكافل الاجتماعي. ووقوع الكوارث الطبيعية غير المتوقعة في السنوات القليلة الماضية أصبحت قضية تحتاج إلى الاهتمام من فقه الزكاة لظهور الفئات المتضررة لها احتياجات ملحة لتغطية نفقاتهم، وهم مصابي الكوارث. وفي الظروف الإندونيسية

مال وبدن على وجه مخصص ص". وتعريفها عند الحنابلة " حق واجب في مال مخصص لطائفة مخصصة في وقت مخصص ص". (2012) الزحيلي:

ومن هذه التعريفات في المذاهب الأربعة، نخلص أن معنى الزكاة هو إخراج جزء مخصص قدره الشارع في الواجب من الزكاة من

⁶⁶ . <http://bnpb.cloud/dibi/tabel1a>

مال مخصوص) نص الشارع أن أموال الزكاة هي المواشي والزرع والثمار وعروض التجارة والنقود والركاز (يعطى إلى شخص مخصوص) وهي الأصناف الثمانية التي ذكرت في سورة التوبة آية ، وهم الفقراء والمساكين والعاملون والمؤلفة قلوبهم والرقاب 60 والغارمون وفي سبيل الله وابن السبيل (بشرط مخصوص) وهو تمام الملك وبلوغ المال للنصاب ومضى الحول (ابتغاء لمرضاة الله .

والزكاة ركن من أركان الإسلام الخمسة ، والأدلة على فرض (27) بينها كثيرة من القرآن والسنة . وقد قرنت الزكاة مع الصلوة (في سبعة وعشرين موضعاً ، وهذا مما يؤكد أهمية الزكاة للأمة الإسلامية بعد أداء الصلوات المفروضة . فمن الآيات القرآنية : قوله تعالى : (42) البقرة : ﴿ وَأَقِيمُوا الصَّلَاةَ وَآتُوا الزَّكَاةَ وَكُونُوا مَعَ الرَّاكِعِينَ ﴾ [وَآتُوا حَقَّهُ كَمَا يُؤْتِيهِ اللَّهُ فِي الْوَسْطَى وَالْجَنَّةِ كَبِيرًا] ، وقوله تعالى : ﴿ خُذْ مِمَّا مَلَكَتْ أَيْمَانُكَ مِنْ مَالِ الْعِلَادِ وَالْجَنَّةِ كَبِيرًا ﴾ [وَآتُوا حَقَّهُ كَمَا يُؤْتِيهِ اللَّهُ فِي الْوَسْطَى وَالْجَنَّةِ كَبِيرًا] ، وقوله تعالى : ﴿ خُذْ مِمَّا مَلَكَتْ أَيْمَانُكَ مِنْ مَالِ الْعِلَادِ وَالْجَنَّةِ كَبِيرًا ﴾ [وَآتُوا حَقَّهُ كَمَا يُؤْتِيهِ اللَّهُ فِي الْوَسْطَى وَالْجَنَّةِ كَبِيرًا] .

وأما من السنة : قوله صلى الله عليه وسلم : « بني الإسلام على خمس : شهادة أن لا إله إلا الله وحده لا شريك له ، وإقرار أن محمدًا عبده ورسوله ، وإقامة الصلاة ، وإيتاء الزكاة ، وحج البيت وصوم رمضان » .

وإرشاد النبي صلى الله عليه وسلم لما بعث معاذًا إلى اليمن : « فأعلمهم الصلاة » .

2 ، وإيتاء الزكاة وحج البيت وصوم رمضان رواه البخاري ومسلم وإرشاد النبي صلى الله عليه وسلم لما بعث معاذًا إلى اليمن : « فأعلمهم الصلاة » .

افتراض عليهم صِدْقَةٌ فِي أَمْوَالِهِمْ تَمْخُ مِنْ أُنْيَاهُمْ وَتُرْدُ عَلَى فُقَرَاءِهِمْ . وأجمعت الأمة الإسلامية سلفها وخلفها أن الزكاة واجبة وهي أحد أركان الإسلام وفريضة من فرائضها . واتفق الصواب على أن الزكاة واجبة على كل مسلم بالغ عاقل مختار قادر على العمل والنفقة . وقد ورد في القرآن الكريم : ﴿ وَالَّذِينَ آمَنُوا وَعَمِلُوا الصَّالِحَاتِ لَنُدْخِلَنَّهُمْ فِي الصَّابِقِينَ ﴾ [وَآتُوا حَقَّهُ كَمَا يُؤْتِيهِ اللَّهُ فِي الْوَسْطَى وَالْجَنَّةِ كَبِيرًا] .

الاستدلال من هذه الآية أن الله عز وجل فضل بعض الناس على بعض في أرزاقهم ، وأوجب على الأغنياء منهم أن يعطوا فقراءهم حقاً واجباً .

المعرضة للكوارث ، من المطلوب أن تكون الزكاة قادرة على تلبية احتياجاتهم بشكل تعويضات مالية لمنعهم الوقوع في دائرة الفقر . وإذا رجعنا إلى آية الزكاة في سورة التوبة حول الأصناف الثمانية ، لم نجد أن مصابي الكوارث من ضمن الأصناف المذكورة ، وبالتالي تظهر مشكلات الدراسة تتركز على الأسئلة التالية :

1. ما الحكم الشرعي في صرف الزكاة إلى مصابي الكوارث الطبيعية؟ وكما المبلغ المدفوع لسد حاجاتهم؟
2. وهل دفع الزكاة لهم موافق لمقاصد فرضية الزكاة؟ وهذه الدراسة ستجيب الأسئلة الثلاثة المذكورة مستخدماً المنهج الوصفي الاستقرائي التحليلي ، بحيث يقوم الباحث بدراسة مقاصد الشريعة في فرضية الزكاة ثم جمع الآراء الفقهية حول دفع الزكاة لمصابي الكوارث وتحليلها ومناقشتها ودراسة مقاصد الشريعة . وستستعمل الدراسة على ثلاثة محاور ، وهي :

المبحث الأول : تعريف فرضية الزكاة المبحث الثاني : مقاصد الشريعة في الزكاة المبحث الثالث : الحكم الشرعي حول صرف الزكاة لمصابي الكوارث

المبحث الأول: تعريف فرضية الزكاة

الزكاة لغة من " الزكاء وهو: النماء والزيادة، ويقال: زكا الزرع إذا نما وازد". وقال ابن الأثير في النهاية: "أن الزكاة في اللغة: الطهارة والنماء والبركة والمدح، فالزكاة طهارة للأموال وزكاة الفطر طهارة للأبدان". (ابن الأثير) (وسمى المال الواجب إخراجه زكاة لأنه يزيد في المال نماء وبركة وتبخر منه من الأفات والهالك، ويظهر نفس المزمكي من البخل وحب الدنيا، ونفس المستحق من الحسد والحقد .

والزكاة شرعاً حق واجب في مال المسلم إذا توافرت شروطها ، وعرفها المالكية أن الزكاة "إخراج جزء مخصوص من مال بلغ نصاباً، لمستحقه، إن تم الملك، وحول، غير معدن وحرث". وللحنفية تعريف على أنها "تمليك جزء مال مخصوص من مال مخصوص لشخص مخصوص ، عينه الشارع لوجه الله تعالى". والزكاة عند الشافعية "اسم لما يخرج عن حوزة المستحق من ظل السؤال وحمائيتهم من أسباب الفقر الأخرى . وأما حفظ النسل من الزكاة يتمثل في تأمين حاجات الفقراء وتطمينهم من الجوع والفقر ، ويتم حفظ العقل بصرف الزكاة إلى طلبه العلم المتفرغ له ضمن أصناف المستحقين . وأما حفظ المال ، فإن الزكاة معناها النماء ، فالمسلم ذو مال يجب عليه استثمار ماله تجنباً من تآكل الزكاة له ، وبالتالي يسعى دائماً إلى استثمار ما يمكن من تحريك ماله ومن ثم دفع الزكاة من الربح لا من أصل المال .

والزكاة شرعت لمحاربة الفقر بشكل عام ، وهذا يظهر من الأصناف الثمانية المذكورة في القرآن . والأصناف الثلاثة (الفقراء والمساكين والرقاب) صرفت لهم الزكاة لمعالجة فقرهم ، بينما الأصناف الثلاثة الأخرى (المؤلفة قلوبهم والغارمون وابن السبيل) صرفت لهم الزكاة لمنعهم من الوقوع في الفقر بسبب دخوله للإسلام أو الدين أو السفر . بينما مصرف العاملين صرفت لهم الزكاة سداً لذريعة الفساد بسبب إدارة الأموال الزكوية لها لتتولى معالجة البطالة بتوفيرهم الشغل . وأما مصرف في سبيل فهو للحفاظ على عزة الإسلام وتأمين نشر الدعوة . ويظهر مقاصد الزكاة في صرفها للأصناف الثمانية على الجدول الآتي :

جدول

المستحق (الصنف)	التعريف	الغاية من صرف الزكاة لهم
الفقراء	من لا يملك ما يسد به حاجته وحاجة من يعول	محاربة الفقر وإغناء حاجاتهم
المساكين	من يملك ما لا يكفي لسد حاجته وحاجة من يعول	محاربة الفقر وإغناء حاجاتهم
العاملون فيه	الموظفون المكلفون بجمع الزكاة وتوزيعها	توفير الوظيفة والتشغول لمعالجة البطالة
المؤلفة قلوبهم	المسلمون حديثوا العهد بالإسلام أو غير المسلمين الذين يرد ترغيبهم في الإسلام	تقريبهم للإسلام وتأمينهم عند دخولهم للإسلام

67 . رواه البخاري في صحيحه ، ج 2 ص 505 باب "وجوب الزكاة"؛ رواه مسلم في صحيحه ، ج 1 ص 103 باب "بيان أركان الإسلام ودعائه العظام ."

ورواه مسلم في صحيحه ، ج 1 ص 111 باب "الدعاء إلى الشهادتين وشأنه في الإسلام". صحيحه ، ج 1 ص 103 باب "بيان أركان الإسلام ودعائه العظام ."

الرقاب	تحريق الرقاب وعتق العبيد من المسلمين	القضاء على الاسترقاق والاستعباد
الغارمون	المدينون الذين جاء موعد وفاء دينهم سواء أكان الدين لنفسه أو لمصلحة غيره ما دام ليس لمعصية الله	تسديد الديون وتخفيف العجز ومنع وقوع الناس في الفقر
في سبيل الله	العمل الموصل إلى رضا الله	المساهمة في الأعمال الخيرية ونشر الدعوة

مفروضاً من أموالهم، لا تطوعاً ولا مئةً من أنفسهم. وفضيلة الزكاة أولى الوسائل لعلاج مشكلة التفاوت بين الناس، وتحقيق التكافل أو الضمان الاجتماعي في الإسلام، يمتثل جوهرها في التواصل وتعزيز الشعور برعاية الآخرين المحتاجين من ذوي الفضل (الأغنياء). فعلى المسلم أن يدرك ويؤمن أن الأموال التي يسعى للحصول دائماً عليها ليست لمصالحه الشخصية فحسب بل فيها مصالح أخرى، منها مصالح المحتاجين والفقر وبناء المساجد والمدارس والمستشفيات وغيرها من الاحتياجات الاجتماعية الضرورية.

المبحث الثاني: مقاصد الشريعة في الزكاة

وجاءت الشريعة الإسلامية لجلب المصالح ودرء المفسدات للعباد التي تتمثل في تحقيق المصالح الأساسية التي ينص الشارع على حفظها، وهي حفظ الدين والنفس والعقل والمال والنسب سواء من جانب الإيجاد أو العدم. وقسم الشاطبي هذه المقاصد إلى ثلاث مارتب، وهي الضروريات والحاجيات والتحسينيات. فالضروريات هي "ما لا بد منها في قيام مصالح الدين والدنيا وبفواتها يحصل الفساد والخسارن في الدارين". وأما الحاجيات هي "ما كان مفقوداً إليها من حيث التوسعة ورفع الضيق المؤدي إلى الحرج والمشقة اللاحقة بفوات المطلوب". بينما التحسينيات هي "الأخذ بما يليق من محاسن العادات وتجنب الأحوال المندسات التي تألفها العقول الارجحات ويجمع ذلك قسم مكارم الأخلاق".

والزكاة جزء لا يتجزأ من نظام الإسلام الاقتصادي، فهو نظام فريد أصيل يعالج مشكلة الفقر أو ما يؤدي إليه، ومشكلة المال بشكل عام . فقال الجويني: "غرض الزكاة سد الخلة والحاجة"، وقال الشافعي:

"المقصود من الزكاة إنما هو سد الخلات، ودفع الجوعات، ورد الفاقات، والإحسان إلى الفقراء، وإغاثة الملهوفين، وإحياء المهج،...." (هشام:

(. وقال ابن اليم: "إن الله قسم خلقه إلى غني وفقير، ولا تتم 2010 مصالحهم إلا بسد خلة الفقير، فأوجب الله عز وجل في فضول أموال (2000) الأغنياء ما يسد خلة الفقراء". (ابن اليم:

بينما علاقة فرضية الزكاة مع مقاصد الشريعة، أن الزكاة شرعاً رعاية الكليات الخمس وإقامتها، من حيث أن مصرف المؤلف قلوبهم وفي سبيل الله مخصصاً لحفظ الدين من خلال نشر الدعوة وتمكين الدين في الأرض وتجهيز الغارة والمجاهدين والإنفاق عليهم ومنع نشر الفتن في الدين بمواجهة الحركات التنصيرية، بالإضافة إلى تأليف قلوب الناس إلى الإسلام. بينما مقاصد الزكاة في حفظ النفس من الهلاك وفوت الحياة

ت. من الذي لا يملك دون نصاب النقود والأموال الزكوية

(2007 الأخرى). (القرضاوي:

. القول الثاني: وتو طول الجمهو. ومسألة الفقر والمسكنة 2

عندهم لا يدور حول ملك النصاب أو لا، بل على عدم ملك

الكفاية. وقال المالكية والحنبالية ما يرد بالكفاية هو كفاية السنة، بينما قال الشافعية أنه كفاية العمر الغالب. والفقير هو "من لا مال له ولا كسب أصلاً، أو كان يملك أو يكتسب أقل من نصف ما يكفيه لنفسه ومن تجب عليه نفقته (ممنونه) من غير إسراف ولا تقتير". والمسكين: هو "من يملك أو يكتسب نصفاً يحتاجه فأكثر، ولكن لم يصل إلى قدر دارهم يومياً ولا يجد إلا أربعة 10 كفايته". ومن يحتاج إلى أو أقل فهو فقير، بينما من وجد سبعة أو ثمانية فهو مسكين. (2012) (الزحيلي:

ويعطى الفقراء والمساكين نصيباً من الزكاة بقدر ما يكمل لهم كفايتهم من النفقة (عاماً كاملاً) (كامل الحول)، باعتبار أن كفايتهم تشمل كفاية من يعولهم من الأكل والشرب والسكن والكسوة حتى تمكينهم بالزواج إن لم يكن قادراً عليه إلا أن يأخذ سهماً من الزكاة.

وقد أفنى مجلس الترجيح والتجديد لجمعية المحمدية بأن مصابيح الكوارث الطبيعية مع ظروفه التي تحتاج إلى مساعدة حية يمكن إدخالهم إلى مستحقّي الزكاة باعتبارهم فقراء أو مساكين، على الرغم من أنه كان في السابق قادراً أو غنياً، لأن الكوارث جعلته فقيراً أو بتلّف وقد ممتلكاتهم، أو أصبح معاقاً جسدياً حتى لا يستطيع أن يوفر حاجاته بنفسه

(Dedy Efendi) (2017) كحاله في السابق .

مصرف الغائبين

الغارمون: جمع غارم: وهم الذين تحملوا الأديون وتعين عليهم أدامها. وأصل الغرم في اللغة: "اللزوم، والغارم: العذاب اللازم، (ومنه 65) الفرقان: "لَلَّالِ عَابَهَا كَالِ - ار ما يومنه قوله تعالى: سمي الغارم لأن الدين قد لزمه، ويطلق الغريم على الدائن لملازمته المدين، وقد يطلق على المدين وسمي كل منهما غريماً لملازمته ص (احبه".) (الأص فهاني: 2009)

والغارمون عند الجمهور قس مان: أو: غارم لمصلحة نفسه في مباح؛ غارم استدان لمصلحة نفسه في أمر مباح، مثل الاستدانة لأجل النفقة أو الكسوة أو الزواج أو علاج المرض أو بناء المسكن أو شراء الأثاث اللازمة، أو التعويض على الشيء أتلفه من غيره سواء علس ببل الخطأ أو السهو، وغيرها. وهذا القس من الغارمين يعطى من

ابن السبيل	المسافر المنقطع عن بلده وأهله فيسفر غير معصية	تمكين الغرباء من العودة إلى بلدهم
------------	---	-----------------------------------

المبحث الثالث: الحكم الشرعي حول صرف الزكاة لمصابي الكوارث

ومن المشكلات الطارئة التي تعرض للبشر ويجب على جميع الناس التعاون بينهم في حلها، وهي الكوارث العامة كالمجاعات التي تنزل بالناس بسبب القحط والجفاف، أو الكوارث التي يعجز عنها كالفياضات التي تغرق الزرع وتهلك الحرث والنسل، أو كوارث الزلازل الطبيعية التي تهدم المباني وتقتل سكانها أو تشرد أهلها. وفي بعض الأحيان، اجتمعت هذه الكوارث كالزلزل والفيضانات، أو تسونامي وأمثلة، فيزداد البلاء والشقاء.

وهنا لا يترك الإسلام أمثال هؤلاء المصابين من فقد المال والولد أو فقدهما جميعاً، دون أن يقدم لهم معونة لازمة تساعدهم على استمرارية الحياة. والزكاة ركن من أركان الإسلام أول الحق الذي يلي حاجاتهم، لأنها شرعت لهذا الغرض، ولكننا لا نجد صراحة وجود مصرف مخصص لهم، فالزكاة مصارفها معلومة ومحددة. وفي هذا المبحث، سيورد الباحث قساً من معاصري لبعض مصارف الزكاة حتى يتمكن صرف الزكاة لمصابي الكوارث الطبيعية أو العامة.

مصرف الفقراء والمسكين

والفقراء جمع من فقير، والمسكين جمع من مسكين؛ وهما لفظان قديان بمعنى واحد إذا تم ذكرهما بشكل منفصل، واختلف الفقهاء على معناهما إذا تم ذكرهما في سياق واحد كما في آية الزكاة. وهما كالإسلام والإيمان من الألفاظ المقولة بين الفقهاء "إذا اجتمعوا افتترقا" لكل لفظ معنى خاص (وإذا افتترقا اجتمعوا) لهما نفس المعنى إذا ذكر منفردا ("المذاهب الأربعة اختلفوا في معنى الفقير والمسكين على قولين:

القول الأول: وتو طول الحنفية، وقالوا معنى الفقير هو 1 "منملك شيئا دون النصاب الشرعي في الزكاة، أو يملك ما قيمته نصاب أو أكثر من الأثاث والأمتعة والثياب والكتب وغيرها مما هو محتاج إليه لاستعماله والانتفاع به في حاجته الأصلية". بينما المسكين عندهم "من لا يملك شيئا"، والمسكين أسوأ حالا من الفقير عند الحنفية. والمستحق الزكاة من صنف الفقير والمسكين عند الحنفية هم: أ. المسكين الذي لا شيء ولا ملك له.

ب. الذي لديه متاع أو بيت أو أثاث أو ملابس ونحوها، وينتفع بها ولا يستغني عنها.

وقاد اختلف الفقهاء في صرف الزكاة للكفار من س هم المؤلفاة قلوبهم. فروي عن الحسن وأبي ثور وأحمد: أنهم يعطون من الزكاة، افعية وأكثر وهذا القول عناد المالكية. بينما قال الحنفية والش أهال العلم أناعطاءهم من الزكاة كان محص وار في عهد رس ول الله ص لى الله عليه وسلم في بداية الإسلام، عندما كانت الحالة المسلمين قلة وأعداءهم كثرة. وأما الآن فقد أعز الله عز وجل دينه الإس لام واس تغنى بأهله عن تال يكفار. ولهذا، فإن الخلفاء ال ارش دين رض ي الله عنهم بعد وفاة الرس ول صلى الله عليه وسلم لم يعطوا الكفار نصيبا من الزكاة. وقال عمر رضي الله عنه: "أنا لا نعطي على الإس لام شا بئنا فمن شا (2012ء فليؤمن ومن شا فليكفر".) الزحيلي:

وإذا كان الرس ول ص لى الله عليه وسلم لم قد أعطى ص نفا للمؤلفة قلوبهم من الكفار شائنا من الزكاة، بيميل الباحث إلى جواز صارف الزكاة لهم، لأن كلمة "المؤلفة قلوبهم" تش مل الكافر والمس لم من الناس، وهذا دليل على جواز تأليف الكافر للإس لام وإعطائه جزء من الزكاة. وعلهذا، يمكن صرف الزكاة لمصابي الكوارث من غير المسلمين مساعدتهم وتأليف لقلوبهم للميل إلى الإسلام.

مصرف ابن السبيل

والم ارد باين السبيل هو "المسافر الذي يجتاز من بلد إلى بلد، وانقطعت به الأسباب في سفره عن بلده ومستق ره وماله" (الأصفهاني:

(. فهو يعطى من الزكاة بقدر ما يوصله إلى بلده وإن كان غنيا 2009 في مسقط رأسه. وروي الطبري عن مجاهد قال: "لابن السبيل حق من الزكاة وإن كان غنيا إذا كان منقطعاً به". وعن ابن زيد قال: "ابن السبيل هو المسافر، سواء كان غنيا أو فقيرا إذا أصيبت نفقته أو فقدت (. 2000 أو أصابها شيء أم لم يكن معه شيء فحقه واجب") الطبري: وبعض العلماء اشتراطوا في إعطاء ابن السبيل من الزكاة ألا يجد من يقرضه ف يالبلد المنقطع، وهذا الشرط للصنف الذي له مال في بلده ويقدر على سداد القرض منه.

ومقدار ما يعطى لابن السبيل هو مقدار النفقة والكسوة والأجرة وغيرها من الحاجات لتمكنه للوصول إلى بلده، وهذا تأمين وإعانة للناس على السفر المباح لبلوغ القصد المشروع. وعلى هذا، يمكن صرف سهم ابن السبيل لمصابي الكوارث الذين جاءوا من خارج منطقة الكوارث، تأميناً لهم بإيصالهم إلى أهلهم وديارهم.

ويمكن تلخيص إمكانية صرف أسهم الأصناف الخمسة المذكورة

الزكاة بقدر ما يقضى به دينه إذا لزمه بالشروط التالية: أن يكون الغارمسا لما محتاجا، واسا تدان في طاعة أو أمر مباح، وأن يكون دينه حالا.

(2007)القرضاوي:

وثانيا: الغارم لمص لحة غيره؛ وهم يغرمون لإص لاح ذات اجر وعاداة في البيئوذلك بأن يقع بين القريتين أو المنطقتين تش الادماء أو الأموال سببها الشحاء، ويتوقف الصلح بينهم على شخص يتحمل تلكالمسؤولية فيتوسط بصلحهم وألزم نفسه مالا تعويضا عما حصل بينهم. وهذا الجهد أمر معروف لإص لاح الناس، وجاءت الش ربيعة باهتمام هذا الأمر وجعل لمن قام بالصلح س هما من الزكاة لثلا يقع المص لحة في الهلاك والجحف بعد قيامه بالأمر العظيم. والدليل على ذلك: قوله صالى

الله عليه وس لم: "يا طيبص لة لال المس ألة تحل لا لأحد ثلاثة: جل تحمل حمالة حت بص بيها ثم يمس أص و جل أص ابته جاحة اجتاحت ماله فحلت له المسألة حت يصيا طواما من أي أو طال سدادا من أي و جل أص ابته فاطة حت يقول ثلاثة من لوج الحجا من طومه:

لقد أصابت فلانا فاطة ص فحلت له المسألة حت يصيا طواما من أي أو طال سدادا من أي فما سواتن من المسألة يا طيبص سحت يأكلها

ص احبها س حتا". رواه أحمد ومس لم والنس اثي وأبو داود⁶⁸. وهذا الحديث يدل على مش روعية ص رف الزكاة للغارمين وإن كان غنيا، وعلى تحر يمس ألة الناس بغير حاجة، وأن من س ال غيره وليس له حاجة به فإنه قد أكل سحتا أي ح ارما .

واسا تنادا إلى هذا الحديث، أفتى القرضا اوي بجواز صا رف الزكاة لمص ابى الكوارث لأن الرس ول أباح ص رف الزكاة لمن أص ابته جائحة اجتاحت ماله، بالسؤال إلى ولي الأمر نصيبا من الزكاة حتى (2007)يتمكن منالبقاء واس تناف حياته مرة أخرى. (القرضا اوي: وكانت الزكاة بهذه الوظيفة نظاما ربانيا س بق نظام التأمين المعاصر ر بكثير لأنها تقوم بمهمة التأمين الاجتماعي للأمة ضد الكوارث ومفاجأة الحياة.

مصرف المملقة طلبهم

والم ارد بالمؤلفة قلوبهم، ض عفاء النية في الإس لام، ققص رف لهم الزكاة لتقوية إس لامهم. وهم قسامان: كفار ومسالمون، فالكفار ص نغان:

الص نف الأول: من يرجى إس لامه بيعطى من الزكاة لتقوى نيته للدخول في الإسلام وتميل نفسه إليه؛ والصنف الثاني: من يخشى شره فيرجى بإعطائه زكاة لكف شره وكف شر غيره ممن معه . العربية.

ابن ال يم الجوزية (2000)، لاعلام الموطعين عن ب العاليمين ص دار ابن الجوزي-المملكة السعودية العربية.

ال ارغب الأصفهاني (2009)، مفردات ألفاظ القرآن ص دار القلم، دمشق-سوريا.

الزحيلي، وهبة (2012)، الفقه الإسلامي وأدلته ص دار الفكر، بيروت-لبنان.

الطبري، محمد بن جرير بن يزيد (2000)، **جامع البیال فیتأویل القرآلص** مؤسسة الرسالة، بیروت-لبنان.

القرضاوي، يوسف (2007) **ص فقه الزكاة داسة مقأونة لأحكامها وفلسفتها في ضوء القرآل والسنة ص مؤسسة الرسالة** ناشرون، بیروت-لبنان.

القرضاوي، يوسف (2008)، **مقاصد الشريعة المتعلقة بالمالص** بحث مقدم إلى الدورة الثامنة عشر للمجلس الأوروبي للافتاء والبحوث، دبليو، يوليو 2008.

هشام بن سعيد أزره (2010)، **مقاصد الشريعة عند لامام الحرمين وأنأوتا في التصرفات المالية ص** مكتبة الرشد، الرياض- المملكة السعودية العربية.

- Badan Nasional Penanggulangan Bencana Alam (2017), **Buku Saku: Tanggap Tangkas Tangguh Menghadapi Bencana.**
- Dedy Efendi (2017), **Pendistribusian Zakat di Yayasan Baitul Maal Bank Rakyat Indonesia (YBM-BRI) Kanwil Medan Terhadap Korban Bencana Erupsi Sinabung**, At-Tafahum: Journal of Islamic Law, Vol.1, No.1, Januari-Juni 2017.

لمصابي الكوارث على الجدول التالية:

جدول

الفئات	مقدا مقدا العهية	الغاية من الإعهاء	الصنف
السكان المحليون الذين من فئات الفق ارء والمساكين قبل الكوارث	على قدر ما يسد حاجاتهم	معالجة الفقر ومنوقوعهم في حالة أكثر سوء	الفق ارء والمساكين
السكان المحليون أو غير ال ازنون المسلمي ن	على قدر الحاجة	تأليف قلوب الناس إلى الإسلام	المؤلفة قلوبهم
من أصبح فقير بعد الكارثة	على قدر الحاجة للتمكن من القوامرة أخرى	منع وقوع الناس في دائرة الفقر، وبالتالي سيزيد عدد الفق ارء	الغارمون
مصابي الكوارث منال ازنون	على قدر ما يوصل إلى منزله م	حماية الناس منالخطر المفاجئ	ابن السبيل

وتم تأكيد تصنيف مصابي الكوارث الطبيعية ضمن مستحق ي حول إدارة الزكاة والقانو 1999 سنة 38 الزكاة استنادا إلى القانو رقم ن ينص أنه بالإضافة إلناأصنا فالثمانية المذكورة فيالقرآن، يمكنصر فالزكاة إلى الضعفاء اقتصاديا، وهم الأيتام وكبار السن والمعاقين واللاجئين النازحين ومصابي الكوارث الطبيعية.

الخاتمة

الحمد لله بنعمته تتم كتابة هذا البحث، وتوصل الباحث إلى النتائج التالية:

1. أن الزكاة نظام رباني، شرعها الله لعباده كوسيلة التكافل والتضامن بين الفئات المحتاجة والفئات الفاضلة، وهي تهدف إلى معالجة الفقر ومنع وقوع الناس في دائرة الفقر .
 2. يمكن الحكومة صرف أموال الزكاة لتلبية احتياجات مصابي الكوارث الطبيعية باعتبارهم من إحدى الأصناف الثمانية، خاصة من أسهم الفق ارء والمساكين والمؤلفة قلوبهم والغارمين وابن السبيل.
- المارج ع**
- (، **النهاية في ربا 2000**• ابن الأثير، مجد الدين بن محمد الجزري)
- الحديث والأثرص** دار ابن جوزي-المملكة السعودية

HEALTH AND NURSING SCIENCES

The Identification of Potential Drug-Drug Interactions and the Factors Influencing the Interactions of the Coronary Heart Disease Patients Hospitalizing in Rumah Sakit Jogja during 2014-2017

Pramitha Esha N.D
 Department of Pharmacy Profession,
 Universitas Muhammadiyah Yogyakarta,
 Indonesia,
 pramithaesha@umy.ac.id

Reny Rosmasari
 Department of Pharmacy Profession,
 Universitas Muhammadiyah Yogyakarta,
 Indonesia,

Abstract- *The number of patients diagnosed with Coronary Heart Disease is at a quite high position in Indonesia, and it increases in each year. Various studies have shown that patients with cardiovascular disease are at risk of suffering from drug interactions. Drug interactions may affect the increase of mortality and morbidity in patients. The purpose of this research is to know the description of the types of potential drug-drug interactions and to evaluate the relationship among the number of drug interaction, the number of drugs consumed, the diagnosis number and how long of CHD inpatients treated in Rumah Sakit Umum Jogja (Jogja Hospital). This study is descriptive research with retrospective data collection method using a cross-sectional design from 91 medical record data of CHD inpatients in Rumah Sakit Umum Jogja in the period of 2014 - 2017. The data analysis uses the spearman test of the SPSS program. The result from 91 samples included in the inclusion criteria is that the number of potential drug interactions is fairly high that is as many as 151 kinds of events. The most frequent mechanism pattern is pharmacodynamics (50.33%). The pattern of potential drug interaction based on the biggest onset was onset delay (83.44%). The highest level of the potential interactions is moderate severity (35.10%). The most documentation is unlikely (35.10%), and the highest significance level is the level of significance 1 (25.17%). This study showed a correlation between the number of potential interactions and the number of drugs ($r = 0.496$, $p = 0,000$). There was no correlation among the number of potential interactions, the number of diagnoses ($r = 0.099$, $p = 0.350$) and how long is the hospitalization ($r = 0.115$; $p = 0.276$).*

Keywords- *Potential Drug Interaction, Coronary Heart Disease*

I. INTRODUCTION

Based on the statistical data from the World Health Organization (2015), Coronary Heart Disease caused around 7,4 million death cases of cardiovascular in 2015. The number of patients diagnosed with CHD in Indonesia is at the seventh position in the category of non-communicable disease (NCDs). Meanwhile, in Daerah Istimewa Yogyakarta Province (DIY), it reaches 1,3% or around 36.104 people (Riskesdas, 2013). Various researches show that the cardiovascular patients are at risk of suffering the drug interactions (Ismail et al., 2013).

Drug interaction is one of the Drug Related Problems which is still to be the main challenge in clinical practice (Krahenbuhl-Melcher et al., 2007). Drug interactions can influence the increase of mortality and morbidity of the patients. It is estimated that 4.8% to 16.8% of hospital losses are caused by drug interaction. The patients with more than one diagnosis must consume more drugs. It can trigger a worse drug interaction. The drug can interact with food, drinks, or with other drugs consumed by the patient (Becker ML et al., 2007).

Cardiovascular drugs are the drugs which often cause potential drug interaction with other drugs (Baxter & Preston, 2010; Mendell et al., 2011). It happens because of the complex dosage regimen and comorbid disease conditions in these patients (Straubhaar B et al., 2006). Based on the research conducted by Murtaza et al. (2015), from the total of the inpatients, 91.1% patients of cardiovascular disease suffer the drug-drug interaction. Patients with special treatment in the hospital need to get more attention related to the drug interaction. Several researches show that drug-drug interactions and the other adverse drug effects are the main clinical problem of heart disease inpatients (Passarelli et al., 2005).

II. METHODS

This is a descriptive study with retrospective data collection method using a cross-sectional design from the medical record data of CHD inpatients in Rumah Sakit Umum Jogja in the period of 2014 - 2017. The population of this research is all of the CHD inpatients in Rumah Sakit Umum Jogja from 2014 to 2017. It used total sampling technique. The tools used in this study are book reference related to drug interaction (Drug Interaction Facts oleh David S. Tatro 2010 and Stockley's drug interaction 8th edition 2008) and other related references. The research material used in this study is the archive of CHD patients' medical records in the period of 2014 - 2017

III. DATA ANALYSIS

The data obtained was analysed with statistics descriptive, then the data is presented in the form of quantitative and qualitative. Quantitative data are presented in the form of the kind of potential drug-drug interaction percentage. Meanwhile, data qualitative is presented in the form of analysis result description with a literature approach. Data analysis to see the relationship among the occurrence of potential drug interaction, the amount of the drugs consumed, the number of the diagnosis and the duration of the CHD inpatient treatments used spearman test on SPSS program

IV. RESULT AND DISCUSSION

1.1 Patients Characteristics Based on the Gender

From the result of the data analysis, most of the CHD patients are men. It is in line with the study conducted by Yuliani et al. (2014). There is a significant relationship among the prevalence of men of CHD patients. For women, the risk of having CHD will increase after the menopause which causes the changes of fat metabolism in the body. So, the risk of developing CHD in women is 10-20 years slower compared to men. (Matthews et al., 2001).

TABLE I. PATIENT CHARACTERISTIC BASED ON AGE

Age (year)	The number of the patients (n)	(%)
26-35	1	1.10
36-45	4	4.40
46-55	27	29.67
56-65	29	31.87
> 65	30	32.97
Total	91	100

According to the data in table 1, most of the CHD patients are in the age group ≥ 65 years old of 32.97%. It is supported by the research data that coronary arteries will begin to change in the early 20th years old. Other changes will happen after the age of forty. For men, the changes in coronary arteries will happen in the age of 35-45 years old and will keep growing as the age grow (Supriyono, 2008).

1.2 Patients Characteristic Based on Comorbidities

Ischemic Heart Disease (IHD) is a disease with the biggest number in this study. IHD is the process of reduced oxygen or the cessation of blood flow to the heart due to narrowing of the coronary arteries by plaque (Sukandar et al., 2008). The second biggest number of diseases is hypertension. Someone with CHD can have 2, 25 times higher risk of hypertension compared those who didn't suffer CHD (Anwar, 2004). A lot of researches stated that the factor of CHC is dyslipidaemia. Dyslipidaemia is a condition caused by abnormal blood lipid level such as the decreased of HDL (High-Density Lipoprotein), the increase of LDL level (Low-Density Lipoprotein) and triglycerides (Kiran, 2010). The disease of diabetes mellitus can have a big role in the cause of CHD. According to the American Heart Association (2012), 65% of diabetes mellitus patients die because of heart disease

1.3 The Description of The CHD Drugs Use

From the table 2, it can be known that the most widely used drugs for CHD in Rumah Sakit Umum Jogja are the nitrate and antiplatelet drugs and drugs for heart failure such as diuretics. The typical chest pain is a result of the lack of oxygen flowing to the heart muscle. This lack of oxygen caused by atherosclerosis process (Almasdy *et al.*, 2013). Antianginal drugs aim to treat complaints of chest pain, and the most widely used with the percentage of 13.01% is nitrate drugs, Isosorbide Dinitrate (ISDN). The nitrate mechanism can dilate coronary arteries which experience atherosclerosis, and it is effective to remove acute chest pain (PERKI, 2015).

Table II.

Description of Drug Use

Type	The Number of Drug Use	Percentage (%)
ISDN	38	3.53
Furosemid	36	3.34
Clopidogre l	34	3.15
Aspirin	54	5.01
Other	916	84.97
Total	1078	100

Loop diuretic drug classes such as furosemide are the second largest drug use after ISDN in heart disease patients in Rumah Sakit Jogja with a percentage of 12.33%. Diuretics can relieve symptoms in patients with moderate to severe congestive heart failure. Diuretics work by reducing the volume of extracellular fluid without causing a reduction in cardiac output (Ooi & Colucci, 2008). Diuretics can control the symptoms of fluid retention and reduce the heart failure. The administration of diuretic combined with ACEI and β -Blockers can produce better therapy (Hunt *et al.*, 2005). Antiplatelet drugs such as clopidogrel and aspirin are widely prescribed in CHD patients with a percentage of 11.64%. Antiplatelet is given to prevent coronary thrombosis; aspirin is the first choice drug given every day for a long-term with a loading dose of 150-300 mg and maintaining a dose of 75-100 mg. Clopidogrel is recommended as an alternative for the patients who cannot get aspirin therapy. The loading dose of clopidogrel is 300 mg continued with 75 mg for daily use (PERKI, 2015).

1.4 The Analysis of the Potential Drug Interaction Based on Interaction Mechanism

The result of the analysis in Table 3 shows the number of potential drug-drug interaction in the mechanism of pharmacokinetics potential interaction as many as 28.48% or 43 incidences. The mechanism of potential pharmacodynamics interaction is 76 incidences (50.33%), and the mechanism of unknown potential interaction is 32 incidences (21.19%).

TABLE III. POTENTIAL DRUG INTERACTION BASED ON THE MECHANISM

Mechanism	Number of incidence	(%)
Pharmacodynamics	43	28.48
Pharmacokinetics	76	50.33
Unknown	32	21.19
Total	151	100

The result of the analysis in Table 3 shows the number of potential drug-drug interaction in the mechanism of pharmacokinetics potential interaction as many as 28.48% or 43 incidences. The mechanism of potential pharmacodynamics interaction is 76 incidences (50.33%), and the mechanism of unknown potential interaction is 32 incidences (21.19%).

The potential interaction between digoxin and furosemide is the potential pharmacodynamics interaction which has a number of incidences. Based on several researches, toxicity from digoxin will increase due to its use in conjunction with a diuretic agent, furosemide. It is caused by the furosemide diuretic agent can cause electrolyte disturbances in the body, namely a decrease in serum potassium and magnesium, thus affecting digoxin to induce arrhythmias. That interaction can be solved by adding the vitamin potassium and magnesium or by replacing the use of less potassium- diuretics while still controlling the levels of these ions in the blood (Tatro, 2010). Another research said that the use of drug combination of digoxin and diuretic such as loop diuretics, thiazide diuretics and fewer potassium-diuretics that can increase the inpatient risk of the heart disease patients with a threefold increase in risk (Wang *et al.*, 2010).

The next potential interaction is potential pharmacokinetics interactions with 43 number of incidences. The most potential interactions with the incidence number of 5 are the potential pharmacokinetic interactions between clopidogrel and simvastatin. The effect of this interaction is the decrease of antiplatelet effect from the clopidogrel. It is because the clopidogrel metabolism becomes its active form through CYP3A4 enzyme blocked by simvastatin (Tatro, 2010). Several researches showed that the daily use of clopidogrel 75 mg together with the use of simvastatin 20 mg for 7 days could decrease the antiplatelet response of 31%. However, in the random research to the patients, the administration of simvastatin at 24 hours before the administration of clopidogrel does not change the effect of antiplatelet. So, the interaction of clopidogrel and simvastatin can be avoided (Stockley & Baxter, 2010).

1.5 The Analysis of Potential Drug Interaction Based on Onset

From the research of potential drug-drug interaction based on its onset, rapid onset has 25 potential incidences with the percentage of 16.56% and onset *delay* has 126 potential incidences with the percentage of 83.44%. The potential interaction between bisoprolol or other beta blocker agents and aspirin NSAID agents portrays rapid onset

potential drug interaction with the most incidence number in this research. Aspirin can inhibit prostaglandin biosynthesis which has a mechanism of blood vessels dilatation. The effect of prostaglandins inhibited by aspirin is the increase in blood pressure and reduce the effects of bisoprolol (Tatro, 2010). The use of aspirin for more than one week can decrease the prostaglandin synthesis. Aspirin and bisoprolol can increase the serum of potassium in the blood. Thus it needs special attention such as blood pressure monitoring and monitoring of potassium serum (Medscape, 2018).

TABLE IV. THE POTENTIAL DRUG INTERACTION BASED ON ONSET

Onset	Number of Incidences	(%)
<i>Rapid</i>	25	16.56
<i>Delay</i>	126	83.44
Total	151	100

The onset *delay* potential interactions are mainly found in aspirin and clopidogrel with the interaction number of 16 incidences. Then, the second widely occur of potential drug interaction with onset *delay* is the potential interaction between digoxin and furosemide. If the use of these two drugs cannot be avoided, special monitoring such as the digoxin level in the blood and the risk of bleeding of the use of both antiplatelet agents (Tatro, 2010).

The Analysis of Potential Drug Interaction Based on The Severity

Potential drug interactions based on the severity in table 11 are among other; major is 39 incidences (25.83%), moderate 53 incidences (35.10%), the minor is 49 incidences (32.45%), and severity of unknown potential interaction is 10 incidences (6.62%).

TABLE V. PERCENTAGE OF POTENTIAL DRUG INTERACTION BASED ON SEVERITY

Mechanism	Number of Incidences	(%)
Major	39	25.83
Moderate	53	35.10
Minor	49	32.45
Unknown	10	6.62
Total	151	100

In the analysis of this research, the potential interaction between clopidogrel and aspirin is the interaction which most widely happens based on the major severity; it is 16 incidences. The interaction of digoxin and furosemide is the second most widely happens with the incidence number of 11 incidences. This interaction can increase toxicity from digoxin so that it can cause unwanted effects (Tatro, 2010).

The potential drug interaction between bisoprolol and aspirin are the most widely happen for the category of potential drug interaction based on moderate severity. The interaction between those two drugs can decrease the effect of bisoprolol as an antihypertensive agent so, it is necessary to monitor the patient's blood pressure (Tatro, 2010). The next is the interaction between ceftriaxone dan furosemide.

Several literatures said that the interaction between those two drugs could increase the kidney damage, but the mechanism of the cause of kidney damage due to this interaction is still unknown (Binay *et al.*, 2017; Jaferi & Geetha., 2017; Medscape, 2018).

The effect caused by the severity of minor potential interaction is harmless and does not affect therapeutic results. For example is the interaction between ranitidine and diazepam, some types of H2 receptors such as cimetidine are known to interfere with the metabolism of benzodiazepines by inhibiting enzymes in the liver. The interaction between methylprednisolone and furosemide can cause electrolyte disturbances which are the decrease of potassium level in the body. Although this interaction is included in minor severity, monitoring the response of patients who receive medication still must be conducted (OĞLU *et al.*, 2016).

TABLE VI. PERCENTAGE OF POTENTIAL DRUG INTERACTION BASED ON INTERACTION DOCUMENTATION

Documentation	Number of Incidence	(%)
<i>Established</i>	1	0.66
<i>Probable</i>	46	30.46
<i>Suspected</i>	27	17.88
<i>Possible</i>	24	15.89
<i>Unlikely</i>	53	35.10
Total	151	100.00

Based on this analysis, the highest number of potential interactions in this unlikely interaction documentation is 35.10% or as many as 53 potential incidences. The probable interaction documentation is 46 incidences with percentages of 30.46%. Suspected interaction documentation as many as 27 potential incidences (17.88%), and possible documentation as much as 15.89% or 24 potential incidences. In established interaction documentation there is only one potential interaction incidence with a percentage of 0.66%.

TABLE VII. PERCENTAGE OF POTENTIAL DRUG INTERACTIONS BASED ON SIGNIFICANCE LEVEL

Significance Level	Number of Incidence	(%)
1	38	25.17
2	29	19.21
3	4	2.65
4	18	11.92
5	28	18.54
Unknown	34	22.52
Total	151	100.00

Analysis of the highest level of significance is the type of significance level 1 with a percentage of 25.17% or as many as 38 potential interactions. The lowest level of potential interaction incidence is at the significance level 3 with the number of potential incidences of 4 or 2.65%. Table 7 shows that the potential interaction based on the level of significance 1 is mostly experienced by clopidogrel and aspirin drugs interactions. It is 16 incidences. The interaction between

digoxin and furosemide have the number of potencies as many as 11 incidences. The risk of the interaction with the level of significance 1 is that it can cause death effects in patients such as the increased of bleeding effects due to clopidogrel and aspirin drugs interaction, and arrhythmia induction due to furosemide use along with digoxin. If the drug combination cannot be avoided such as the use of combination drugs of clopidogrel and aspirin, the administration of this combination drugs must be conducted very carefully. The bleeding risk can be avoided by using aspirin with the dose of no more than 100 mg (Plavix, 2009). The interaction between furosemide and digoxin can be solved by adding the potassium vitamin and magnesium. Thus, the electrolyte levels in the blood remain controlled and do not result in arrhythmia induction in digoxin, or by replacing the use of less potassium- diuretics while still controlling the levels of these ions in the blood (Tatro, 2010).

4.7 The Analysis of the Relationship of Potential CHD Drug Interaction

Various factors thought to influence the drug interaction to the CHD inpatients in Rumah Sakit Jogja are the number of the drug consumed, the number of the diagnoses, and the duration of the inpatient. From those factors, a correlation analysis was conducted to know the relation among the number of potential drug interaction, the number of the drugs consumed, the number of the diagnoses and the duration of the inpatient with the *SPSS Spearman test* method. The number of the samples in this study is more than 50 or as many as 91 samples. Then the normality test with Kolmogorov-Smirnov is conducted, and the result is that the data distribution from the sample is not normal. The number of potential interaction incidences is taken from theoretical analysis results that include potential interactions based on severity, mechanism, onset, documentation, and level of significance.

TABLE VIII. RISK FACTORS FOR DRUG INTERACTIONS

Risk Factors	P Value	Correlation Coefficient
Number of Drugs Consumed	0.000	0.496
Inpatient Duration	0.276	0.115
Number of Diagnoses	0.350	0.99

If the value of r is about 0.00-0.199, its correlation power is very weak. Then if the value is 0.20-0.399, the correlation is weak. If the value is 0.40-0.599, the correlation is moderate. If the value is 0.60-0.799, the correlation is strong. And if the value is 0.80-1.00, the correlation is very strong. Table 16 shows the correlation power of 0.496. It means the power of that correlation is moderate. It is in accordance with the research conducted by Dasopang *et al.* (2015), as the number of drugs consumed increase, the higher the number of potential drug interactions.

The number of diagnoses and the duration of inpatient do not show the correlation result to the number of potential drug interaction incidences. The duration of CHD patients staying

in the hospital is not related to the number of potential interactions. It can be seen from the analysis which shows the *p-value* of 0.276 or > 0.05 that means there is no significant relationship between the number of potential drug interaction and the duration of the inpatient of CHD patients. It is different from the study conducted by Murtaza *et al.* (2015), which said that the duration of the inpatient is one of the factors related to potential drug interaction incidences. Other several researches such as the study conducted in Brazil showed that the patients with longer duration of inpatient have a significant relationship with the potential drug interaction incidences (Riechelmann *et al.*, 2005).

The value of *p-value* resulted for the number of diagnoses is 0.350 or > 0.05 which means that there is no relation between the number of diagnoses received by the patients and the number of potential drug interaction. It is different from several existed researches. What should happen is that there is a relationship between the number of diagnoses and the number of patient drug interactions. It is because the more diseases suffered by the patients resulted in the more drugs administered to the patients, thus increasing the number of drug interaction (Dasopang *et al.*, 2015).

V. CONCLUSION

The study reported the fairly high number of potential drug interactions as many as 151 events. The most frequent mechanism pattern is pharmacodynamics (50.33%). The pattern of potential drug interaction based on the biggest onset was onset delay (83.44%). The highest level of the potential interactions is moderate severity (35.10%). The most documentation is unlikely (35.10%), and the highest significance level is the level of significance 1 (25.17%). This study showed a correlation between the number of potential interactions and the number of drugs ($r = 0.496$, $p = 0,000$). There was no correlation among the number of potential interactions, diagnoses ($r = 0.099$, $p = 0.350$) and the hospitalization period ($r = 0.115$; $p = 0.276$).

REFERENCES

- Almasdy, D., Darwin, D., Kurniasih, N., & Handayani, V. 2017. Pola Penggunaan Isdn pada Penderita Angina Pektoris di Suatu Rumah Sakit Pemerintah Kota Padang. *Jurnal Sains dan Teknologi Farmasi.*, 18 (1), 61-68.
- Anwar, T.B. 2004. Faktor risiko penyakit jantung koroner. Diakses 1 Juni 2018, dari <http://repository.usu.ac.id/bitstream/123456789/3472/1/gizi-bahri4.pdf>.
- Baxter, K., Preston, C.L. 2010. Stockleys drug interactions 9th edition1. London: Pharmaceutical Press London.
- Binay, G., Jitty, J., Arun, R., Divya, J., Rajeswari, R., TV, V., Shashidhar, G. 2017. Study on polypharmacy and potential drug – drug interactions in drug therapy of elderly patients at a tertiary care teaching hospital. *Int J Pharm.*, 7(2), 60-68.
- Dasopang, E. S., Harahap, U., & Lindarto, D. 2017. Polifarmasi dan Interaksi Obat Pasien Usia Lanjut Rawat Jalan dengan Penyakit Metabolik. *Indonesian Journal of Clinical Pharmacy.*, 4 (4), 235-241.
- Hunt SA et al. 2005. Guideline update for the diagnosis and management of chronic heart failure in the adult. *European Journal Of Heart Failure*. Diakses tanggal 21 Desember 2011, dari <http://www.EuropeanHeartJournal.com/2011/>.
- Ismail, M., Iqbal, Z., Khan, M.I., Javaid, A., Arsalan, H., Farhadullah, H., Khan, J.A. 2013. Frequency, levels and predictors of potential drug-drug interactions in a pediatrics ward of a teaching hospital in Pakistan. *Trop. J. Pharm. Res.*, 12 (3), 401–406.
- Jaferi, F., & Geetha, K. M. 2017. Interaction Between Anti Hypertensive Drug and Other Classes Of Drug In Cardiac Patient. *J. Pharm.*, 8 (68), 567-570.
- Kra“henbu“hl-Melcher, A., Schlienger, R., Lampert, M., Haschke, M., Drewe, J., Kra“henbu“hl, S. 2007. Drug-related problems in hospitals. *Drug Saf.*, 30 (5), 379–407.
- Medscape. 2018. Drug Interaction Checker. Diakses tanggal 27 Juni 2018, dari <http://www.reference.medscape.com/drug-interactionchecker>.
- Murtaza, G., Khan, M. Y. G., Azhar, S., Khan, S. A., & Khan, T. M. 2016. Assessment of potential drug–drug interactions and its associated factors in the hospitalized cardiac patients. *Saudi Pharmaceutical Journal.*, 24(2), 220-225.
- OĞLU, M. G. İ., KÜÇÜKİBRAHİMOĞLU, E., Karaalp, A., SARIKAYA, Ö., Demirkapu, M., Onat, F., & GÖREN, M. Z. 2016. Potential drug drug interactions in a medical intensive care unit of a university hospital. *Turkish journal of medical sciences.*, 46 (3), 812-819.
- Ooi, H. and Colucci, W.S. 2008. Pengobatan Farmakologis Gagal Jantung. In: Goodman and Gilman. *Dasar Farmakologi Terapi*, (Edisi 10). Jakarta: Penerbit Buku Kedokteran EGC.
- PERKI. 2015. Pedoman Tatalaksana Hipertensi pada Penyakit Kardiovaskular, (Edisi 4). Perhimpunan Dokter Spesialis Kardiovaskular Indonesia, Jakarta.
- Plavix. Clopidogrel hydrogen sulphate. 2009. Sanofi Pharma Bristol-Myers Squibb SNC., 34 (1), 89-93.
- Riechelmann, R.P., Moreira, F., Smaletz, O., Saad, E.D. 2005. Potential for drug interactions in hospitalized cancer patients. *Cancer Chemother. Pharmacol.*, 56 (3), 286–290.
- Stockley., Baxter, K. 2010. Stockley’s Drug Interaction, (9th Edition). London: Pharmaceutical Pr.
- Straubhaar, B., Kra“henbu“hl, S., Schlienger, R.G. 2006. The prevalence of potential drug-drug interactions in patients with heart failure at hospital discharge. *Drug Saf.*, 29 (1), 79–90.
- Tatro D.S. 2010. *Drug Interaction Facts: The Authority on Drug Interactions*. California: Wolters Kluwer Health
- Wang, M. T., Su, C. Y., Chan, A. L., Lian, P. W., Leu, H. B., & Hsu, Y. J. 2010. Risk of digoxin intoxication in heart failure patients exposed to digoxin–diuretic interactions: a population-based study. *British journal of clinical pharmacology.*, 70(2), 258-267.

21. Wijayanti, H. B. 2014. Evaluasi Penggunaan Obat Pada Pasien Jantung Koroner Dengan Komplikasi Hipertensi Di Instalasi Rawat Inap RSD dr. Soebandi Jember, Tesis, Universitas Jember, Jember.
22. WHO. 2018. World Health Statistics 2015. World Health Organization,2015. Diakses 25 Juni 2018, dari http://www.statisticshealth.gov/statistic-health-topics/lgbt/lgbt_report.html.
23. Yuliani, F., Oenzil, F., & Iryani, D. 2014. Hubungan berbagai faktor risiko terhadap kejadian penyakit jantung koroner pada penderita diabetes melitus tipe 2. Jurnal Kesehatan Andalas., 3 (1), 11-15.

Determining Nutritional and Health Habits of Bajao People in Relation to Their Health Status: Basis For Health Education

1st Abdullah Junior S. Mangarun
MSU-Iligan Institute of Technology,
College of Nursing
Iligan City, Philippines
abdullahjr.mangarun@g.msuiit.edu.ph

2nd Wraida D. Bacarat
MSU-Iligan Institute of Technology,
College of Nursing
Iligan City, Philippines
wraida.bacarat@g.msuiit.edu.ph

3rd Jomaira U. Hadji Jamil
MSU-Iligan Institute of Technology,
College of Nursing
Iligan City, Philippines
jomaira.hadjijamil@g.msuiit.edu.ph

Abstract— *Healthy diet and physical activity are proven to be key to a good nutrition and significant for a healthy and long life which everybody aspire to have. Eating nutrient-rich foods and maintaining a healthy lifestyle is essential in all stages of life. This study examined the demographic profile, level of knowledge regarding treatment of common health concerns and nutritional habits in relation to the badjao's health status. The study made use of descriptive research design specifically cross sectional design. Both standardized and self-made questionnaire were used to gather data. The study was conducted in Tambacan, Iligan City where Bajao people reside. It made use of purposive sampling wherein a total of 150 respondents are selected based on the criteria necessary to answer the objectives of the study. At least 12 years old and recognized by the tribe leader as member of the Bajao community. Results revealed that there was no significant relationship between the health status of the respondents and their personal food intakes. Moreover, there was a significant association between their health habits and their health status. Lastly, there was no significant relationship between their level of knowledge and health status. The study concluded that their nutritional habits cannot be a determining factor for their health status specifically risk for having diet-related health concerns, but health education could still create impact in regards with disease prevention and medical treatment awareness. Creation of significant awareness programs and activities focusing directly to Bajao people of Barangay Tambacan in Iligan City by the Local Government Unit and Non-Government Organizations are highly recommended.*

Keywords— *Nutritional habits, Bajao, Health status*

Introduction

It has been a proven fact that eating a balanced diet is vital for good health and well-being. Food undeniably provides our bodies with the energy, protein, essential fats, vitamins and minerals to live, grow and function properly. Every human being needs a wide variety of different foods to provide the right amounts of nutrients for good health yet enjoyment of a healthy diet can also be one of the great cultural pleasures of life. Many research were conducted which proved an increased risk of many diet-related diseases that arise from unhealthy diet and disregarded proper nutrition.

It is somehow disregarded information that nutritional risk factors are possible and if not rendered enough attention then

it could really affect health of a person. The main grounds of illness, disability and death in which nutrition and diet play a vital role include stroke, coronary heart disease, hypertension, obesity, atherosclerosis, osteoporosis, some forms of cancer, dental caries, Type 2 diabetes, gall bladder disease, nutritional anemia and dementia [4]. It cannot be denied that due to widespread of poor lifestyle habits especially concerning nutrition, those aforesaid illnesses are undeniably and slowly becoming common to people. It is an unwanted reality that the Bajao community doesn't receive as much attention and won't be able to grab significant information about health concerns.

The researchers came up to bringing this concept into research because they firmly believe that it is a very significant topic and widens awareness of the nutritional risk it carries that might lead to alarming health concerns that must be given attention even more especially in research studies. Through proper assessment of the Bajao's nutritional habits, this could strongly support the other studies made concerning about role of nutrition on health status that could further implement health education, and more importantly gaining and eventually additional information to be gathered.

The purpose of this study is to determine and assess the nutritional habits in relation to the health status among Bajao people which in turn could build collaborative interaction leading to formulation of appropriate actions through properly planned measures. Most importantly, this study aims to render nursing education in proportion to the core of the study.

Methodology

Descriptive type of research specifically cross sectional study design was used as the method by the researchers. A quantitative research aims to explain the causes of phenomena through objective measurement and numerical analysis. Descriptive research was used to describe the appearance of a population being studied. This implies that use of systematic procedures to obtain numerical data that are subjected to a rigorous statistical analysis is needed. A cross-sectional study includes looking at people who vary on one key characteristic at one specific point in time.

The respondents of this study came from one single location in Iligan City, Philippines specifically in barangay of Tambacan where most Bajao people reside.

Tambacan is one of the 45 barangays of Iligan City. It is bounded by Tubod river and Barangay Poblacion. There is a hanging bridge located nearby the wet market which is the common route to enter Barangay Tambacan. The specific location of the Bajao people is near the seashore.

Purposive sampling was utilized in this study wherein participants were selected basing on the criteria needed to obtain the study objective. Criteria in choosing the respondents are as follows: 1) He/she should be at least 12 years old. 2) He/she should be recognized by the tribe leader as member of the Bajao community. 3) Resident of Barangay Tambacan, Iligan City wherein majority of Bajao in Iligan City resides. A total of 150 respondents were interviewed.

To gather the necessary data and information, both standardized and a researcher made questionnaire which was pilot tested were used. It is all about the health habits and demographic profile of the participants. This encompassed the age, weight, height, gender, personal food choices, family history, clinical signs of potential nutrient deficiencies and typical drugs they used to treat common health problems.

Survey questionnaires and proper objective observation were used. The researchers initiated in reading each question and explained in a simpler and understandable manner. Most of the chosen Bajao respondents knew and understand the Bisaya dialect. For those few research participants who have difficulty understanding the Bisaya dialect, the chieftain, Sir Ronni, initiated to translate the questions in their own dialect. Before leaving, the researchers ensured that the respondents were able to answer the necessary items in the questionnaire. The questionnaires were retrieved as soon as the respondents were done.

Chi-Squared Test, also written as χ^2 test was used for data analysis.

Frequency and Percentage Distribution was a tool that was also used for the respondents demographic profile in terms of Age and Gender.

The researchers ensured the protection of the rights of the study participants and no ethical wrongdoings were committed while conducting the study. Also, the participant's rights were protected by explaining the nature, purpose, goal and the expectations of the study.

Informed consent was secured before the conduct of the study with the participants. They were instructed that they can withdraw or refuse to continue to be part of the study as participants.

RESULTS AND DISCUSSION

Demographic Profile

Age is one of the most significant characteristics in understanding the participants views about the specific problems, and large age indicates level of maturity of individuals in that sense age turn out to be more important to examine the response. Obtaining the gender of the participants could be a significant factor to determine any differences in terms of their health and nutritional habits.

Table 1. Frequency and Percentage Distribution in terms of Age and Gender

	ADOLESCENCE (12-18 years old)		ADULT (19-64 years old)		ELDERLY (65 years-above)		TOTAL	
MALE	27	35.5%	4	59.2%	4	5.3%	76	100%
FEMALE	28	37.8%	4	55.4%	5	6.8%	74	100%
TOTAL	55	37%	8	57%	9	6%	150	100%

As observed, Bajao people are curious and participative. Objectively, it is evident that both male and female Bajao people have equal share of responsibilities in terms of livelihood and they subjectively shared about it.

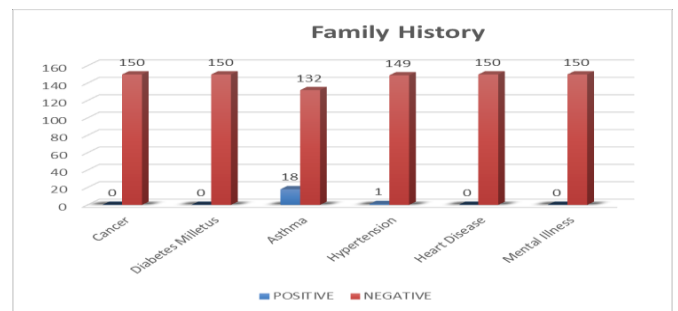

Fig. 1. Family History Graph

Figure 1 represents the family history of the respondents. It shows that the common illnesses present in their family were asthma and hypertension. Out of 150 respondents, 18 shared prevalence of asthma in their family while 1 respondent spoke about having family history of hypertension. The Philippines ranked 161 out of 224 in terms of average life expectancy According to Central Intelligence Agency's World Factbook,. The illnesses presented in the family history were part of the top 10 deadliest diseases prevalent in the Philippines which are hypertension, Coronary Heart Disease, stroke, and Pneumonia and Influenza, tuberculosis, breast cancer, lung disease, kidney disease, Diabetes Mellitus and asthma. Compared to the world the Philippines' life expectancy seems promising however, the aforesaid types of fetal diseases and health complications affect health and decrease a person's life expectancy [6]. The result shown in Figure 3 implies that Asthma was prevalent in the Bajao community, yet they do not have enough knowledge and awareness about its proper treatment.

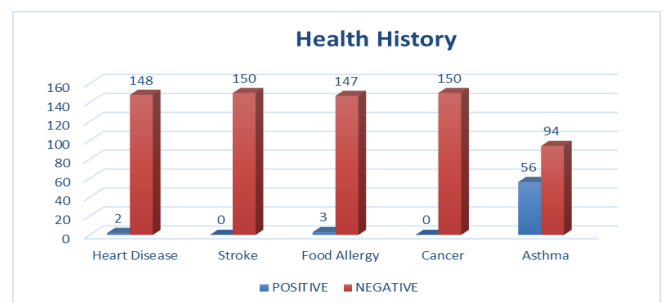

Fig. 2. Health History Graph

Figure 2 represents the health history of the respondents. It shows that 2 respondents shared having health history of heart disease, 3 having food allergies specifically to eggs and dried fish. According to WebMD (2018), 90% of food allergy reactions came from: milk (mostly in children), eggs, soy, peanuts, wheat, shellfish and fish which are common in adults.

Out of 150 respondents, 56 shared to have asthma which is also connected to the prevalence of asthma in their family history as what was shown in Figure 3. According to the Central Intelligence Agency’s World Factbook, it seem harmless, but asthma can be deadly if not given enough attention and right treatment. In the Philippines, asthma affected more than 10 million people, and instigated over 2% of mortality nationwide [6].

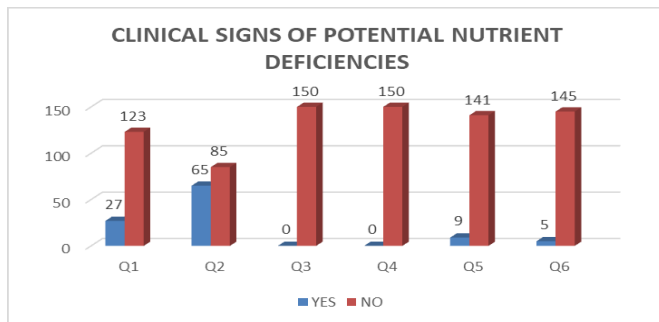

Fig. 3. Clinical Signs of Potential Nutrient Deficiencies Graph

Figure 3 shows the response of research participants to the different questions which are stated below and are connected in determining presence of any clinical signs of potential nutrient deficiencies. Having such signs opens possibility of lacking some of the vital nutrients that the body needs to function optimally. An insufficiency in Nutrient affects normal functioning and processes of the body. These processes include digestion, water balance, nerve signaling, metabolism and enzyme function. Solving these insufficiencies is vital for function, optimal growth and development. Deficiencies in Nutrient can also lead to illnesses [1].

Table 2. Frequency and Percentage Distribution in terms of BMI

BMI	FREQUENCY DISTRIBUTION	PERCENTAGE
Underweight(<18.5)	117	78%
Normal(18.5-24.9)	30	20%
Overweight(25-29.9)	3	2%
TOTAL	150	100%

As shown in Table 2, It is undeniable that most of them are underweight because they do not have enough financial resources to buy foods that they want to eat.

HYPOTHESES: *There is no significant relationship between the BMI and the personal food intake of the respondents.*

Table 3. Descriptive Statistics between BMI and Nutritional Habits

	NUTRITIONAL HABITS			TOTAL
	Everyday	Not at all	Once a week	

BMI	UNDERWEIGHT HT	6	105	6	117
	NORMAL	3	26	1	30
	OVERWEIGHT HT	0	2	1	3
TOTAL	9	133	8	150	

As shown in Table 3, out of 150 research participants, 117 were underweight. It was strengthened by the result that 105 of the respondents don’t eat the food choices presented. According to Centers for Disease Control and Prevention, Body Mass Index is a person's weight in kilograms divided by the square of height in meters. A high BMI indicates high body fat. It is not a diagnostic of the health of an individual, but it can be used as a tool to screen for weight categories that may lead to problems of health [2].

Table 4 Relationship between BMI and Nutritional Habits

Tests – Chi-squared			
	Value	df	Asymptotic Sig. (2-sided)
Pearson Chi-Square	5.965	4	.202
N of Valid Cases	150		

The p-value of 0.202 shows that the hypothesis is not rejected since it is greater than 0.05. Therefore, there is no significant relationship between the BMI and the personal food intake of the respondents. Considering that the research participants regardless of age has the same preferred foods like *balanghoy* and fish, their nutritional habits doesn’t play a big factor in determining their BMI.

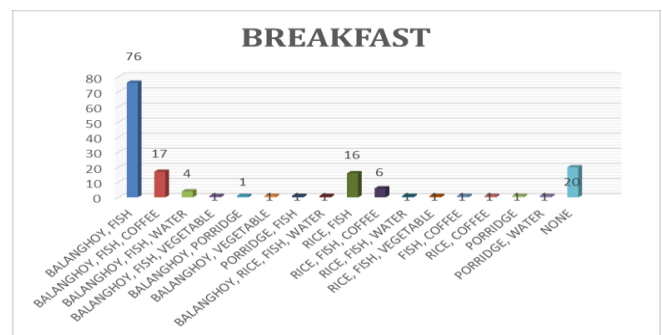

Fig. 4. Common Food Intake during Breakfast

The common food intakes of the respondents during breakfast are shown in Figure 4. It shows that 76 out of 150 respondents, eat *balanghoy* and fish compared to 16 respondents who prefer commercial rice and fish. 15 eat *balanghoy* and fish with coffee, 5 of them prefer commercial rice and fish with coffee, 4 were used to eating *balanghoy* and fish with water and 20 of them do not eat breakfast. *Balanghoy* is a Bisaya term referring to cassava. They preferred eating *balanghoy* than any commercial rice because it is more affordable. They also stated that their hunger was easily relieved by eating *balanghoy*. Most of them chose to combine their meal for breakfast and lunch for a reason that they can only afford two meals within a day. In order for them

to compensate for the missed meal and to sustain their hunger for the whole day, they usually eat breakfast around 10AM. They shared that they start earning through asking for alms from other people and leave their homes around 6AM to comeback at 10AM with foods bought from money earned.



Fig. 5. Common Food Intake During Lunch

Figure 5 represents the common food intake of the respondents during lunch. It shows that out of 150 respondents, 112 do not prefer eating during lunch, 24 like to eat *balanghoy* and fish, 8 eat commercial rice and fish. Bajao people do not eat lunch because according to them they were not used to having lunch due to the reason that they cannot afford a meal for their lunch. As what they shared, they gave more importance to eating breakfast rather than lunch because they felt that they can contain their energy for the whole day

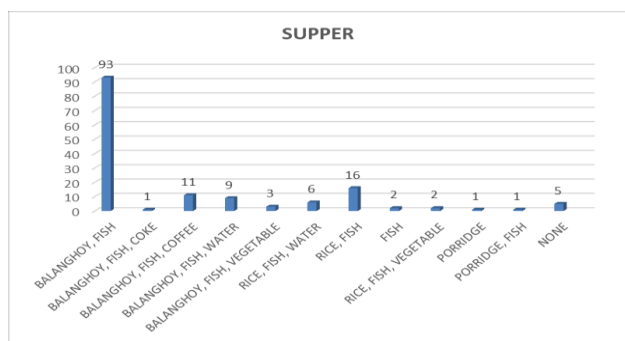

Fig. 6. Common Food Intake during Supper

Figure 6 represents the common food intake of the respondents during supper. It shows that out of 150 respondents, 93 prefer eating *balanghoy* and fish, 16 like eating commercial rice and fish, 11 eat *balanghoy* and fish with coffee, 9 prefer *balanghoy* and fish with water, 6 like commercial rice and fish with water, and 5 of them do not eat at all. Same with breakfast they also preferred eating *balanghoy* because it is affordable and can easily relieved their hunger. They like to have *balanghoy* with fish because their main source of food is through fishing and having the fact that they live near the sea it is more convenient for them to fish. The research participants stated that they preferred steamed way of cooking their meals than other means because they can make more servings and seasonings to accommodate the whole family.

Hypothesis: *There is no significant association between the health status and the level of knowledge of the respondents.*

Table 5. Descriptive Statistics between BMI and Level of Knowledge on Treatment

		Knowledge level on medicine on five common disease			Total
		1 medicine	2 medicines	3 medicines	
B M I	Underweight	60	44	13	117
	Normal	15	14	1	30
	Overweight	1	2	0	3
Total		76	60	14	150

The researchers stated five common symptoms like fever, cough, pain (abdominal, head, tooth), diarrhea and wounds. Almost all of them mentioned certain medications like Paracetamol for fever, Mefenamic for any pain, Amoxicillin for wounds. Only a few mentioned Solmux for cough remedy.

Table 6. Relationship between BMI and Knowledge Level on Treatment

Test Statistics – Chi-Square			
	Value	Df	Asymptotic Sig. (2-sided)
Level of Knowledge	3.057	4	.548
N of Valid Cases	150		

The p-value = 0.548 shows that the hypothesis is not rejected since it is greater than 0.05. Therefore, there is no significant association between the health status and the knowledge level of the respondents considering the fact that they don't have enough awareness regarding treatment especially of the five common symptoms introduced to them in the survey questionnaire. Most of them claimed to have asthma without formal medical diagnosis from a physician but do not have any knowledge about its treatment.

Hypothesis: *There is no significant association between the health status (BMI) and the health habits (smoking and drinking alcohol) of the respondents.*

As displayed in table 7, most of the respondents do not smoke nor drink alcoholic beverages, 115 out of 150 respondents do not smoke, and 131 out of 150 do not drink alcoholic beverages whether they are underweight, normal, or overweight.

Most of the research participants do not smoke nor did drink on a daily basis for a fact that they would rather prioritize using their money in buying foods for their meals than spending it in buying cigarettes or alcoholic beverages. During data gathering, the researchers found out that among the 35 research respondents who smoke, they stated that they started at an early age which was 12 years old. Among the 19 respondents who engaged in drinking alcoholic beverages, they stated that they started at the age of 10 years old.

Table 7. Descriptive Statistics between BMI and Health Habits

		Smoking		Drinking Alcohol		Total
		No	Yes	No	Yes	
BMI	Underweight	98	19	108	9	117
	Normal	16	14	21	9	30
	Overweight	1	2	2	1	3
Total		115	35	131	19	150

According to World Health Organization (WHO), the short-term effects of smoking among young people include non-respiratory and respiratory effects, the associated risk of another drug use, and nicotine addiction. Long-term health effects, smokers have a lower level of lung function than those individuals who have never tried smoking. Smoking decreases the lung growth rate [7]. As eloquently stated by National Institute on Alcohol Abuse and Alcoholism, among youth, alcohol is the drug of choice. Many young adults are experiencing the consequences of taking too much alcohol at young the age. Those who started drinking as young age as 15 were four times more likely to also report meeting the criteria for alcohol dependence at some point in their lives. About 5,000 young adult under the age of 21 die as an end result of underage drinking each year [5].

Table 8. Relationship between BMI and Health Habits

Test Statistics – Chi-square			
	Value	Df	Asymptotic Sig. (2-sided)
Smoking	15.571	2	.000
Drinking Alcohol	11.923	2	.003

Table 8 shows that health habits, smoking and drinking alcohol, having p-value of 0.000 and 0.003, respectively, is less than 0.05. Indeed, there is a significant association between the health status and the health habits of the respondents. Having the fact that those research respondents who smoke and drink alcoholic beverages started those habits at an early age, it could be a significant factor in determining their health status.

Based on a research, [smoking affects](#) everyone’s health, even secondhand smokers. However, it affects young people more profoundly in lots of ways. In addition, according to the [Surgeon General](#), for every 1,200 deaths caused by smoking are replaced by roughly about two young adults. It was found out that early signs of stroke and [heart disease](#) are detected in young people who are smoking. Youth smoking leads to subnormal, limited, or stunted development of the lung. It could even lead to underdeveloped lung capacity. Younger smokers are at higher risk for developing cancer of the [lungs](#), to suffer from psychological or emotional distress, and suffer three times more from shortness of breath than those who do not smoke [6].

Various scholars believe that heavy alcohol intake at an early age may cause long-lasting damages in brain functions such as motor skills, coordination, and memory [3].

Conclusion

Based on the overall result we found out the fact that the research participants have limited resources and income to afford eating three times a day and only eats specific foods like *balanghoy* and fish in every meal of the day. They preferred eating *balanghoy* because it is affordable and can easily relieved their hunger. They like to have *balanghoy* with fish because their main source of food is through fishing and having the fact that they live near the sea it is more convenient for them to fish. The research participants stated that they preferred steamed way of cooking their meals than other means because they can make more servings and seasonings to accommodate the whole family.

Most of them chose to combine their meal for breakfast and lunch for a reason that they can only afford two meals within a day. In order for them to compensate for the missed meal and to sustain their hunger for the whole day, they usually eat breakfast around 10AM. They shared that they start earning through asking for alms from other people and leave their homes around 6AM in order to comeback at 10AM with foods bought from money earned.

Out of 150 Bajao respondents, 117 are underweight, 3 are overweight and 30 has the normal BMI which was still the effect of having no source of livelihood for living. Considering the fact that most of them are underweight, they are highly at risk of having health related problems based on their Body Mass Index (BMI) like growth and development issues, malnutrition, decreased immune function especially in children and teenagers. They lack awareness on treatment of cough and diarrhea which are part of the most common symptoms the researchers mentioned. Asthma which was proven to be part of the top 10 deadliest diseases in the Philippines was prevalent in the Bajao community. The researchers found out that the research participants lack awareness of its treatment. Therefore, this information played a big factor that their nutritional habits is not a determining factor for their health status specifically risk for having diet-related health concerns, but health education could still create impact in regards with disease prevention and medical treatment awareness.

Recommendations

For the development of the study, the researchers have drawn the following recommendations:

To Community/Local Government Unit

1. Encourage the LGU officials and employees to conduct more health awareness programs focusing directly to the Bajao people in Barangay Tambacan, Iligan City.
2. Assess and check the Bajao community more often for potential risks or problems related to their health and to encourage the Bajao people to visit the health center for health assistance.

- Use their connections to introduce the Bajao community to give more attention to their health status that could lead them to come up with properly planned measures to help them.

To Non-Government Organization

1. Formulate programs that focuses on the needs of the Bajao community.
2. Collaborate with different government bodies in providing solutions to the health care needs of the Bajao people.

To Bajao Community

- Participate in the programs conducted by the government especially on health awareness activities.

To Mindanao State University-Iligan Institute of Technology

- Facilitate interventions which will include thorough assessment, action plan, and implementation of proper nutrition programs.

To Future Researchers

1. Expand the scope of respondents in terms of the locale in Iligan City
2. Conduct more research or studies about the Bajao people

References

- [1] [Bowers, E \(2017\). Common Nutrient Deficiencies: Know the Signs. Retrieved from https://www.everydayhealth.com/hs/guide-to-essential-nutrients/common-nutrient-deficiencies/](https://www.everydayhealth.com/hs/guide-to-essential-nutrients/common-nutrient-deficiencies/)
- [2] [Centers for Disease Control and Prevention. 2015. Retrieved from https://www.cdc.gov/healthyweight/assessing/bmi/index.html \(?\)](https://www.cdc.gov/healthyweight/assessing/bmi/index.html)
- [3] HelpGuide, 2018. Alcoholism and Alcohol Abuse. Retrived from <https://www.helpguide.org/articles/addictions/alcoholism-and-alcohol-abuse.htm>
- [4] [Khan, S. \(2018\). Nutritional complications and its effects on human health. Retrieved from https://www.researchgate.net/publication/323357852_Nutritional_complications_and_its_effects_on_human_health](https://www.researchgate.net/publication/323357852_Nutritional_complications_and_its_effects_on_human_health)
- [5] [National Institute of Health \(2006\). Underage Drinking. Retrieved from https://pubs.niaaa.nih.gov/publications/AA67/AA67.htm](https://pubs.niaaa.nih.gov/publications/AA67/AA67.htm)
- [6] Vaping Daily (2018). Tobacco Explained: One of the Most Addictive Substances. Retrieved from <https://vapingdaily.com/quit-smoking/tobacco/>
- [7] World Health Organization, 2018. Retrieved from https://www.who.int/tobacco/control/populations/youth_health_effects/en/

Factors Affecting the Motivation of Nursing Students in Joining the Student Exchange Program

Farida Juanita
Nursing Department
Universitas Muhammadiyah Lamongan
Lamongan, Indonesia
faridajuanita@umla.ac.id

Arifal Aris
Nursing Department
Universitas Muhammadiyah Lamongan
Lamongan, Indonesia
arifalaris@umla.ac.id

Diaz Innova
Nursing Department
Universitas Muhammadiyah Lamongan
Lamongan, Indonesia
diazinnova@umla.ac.id

Abstract— Nursing student exchange is one of the programs held to improve the quality of students, especially in developing nursing cultural competence. However, in its implementation, not all students are motivated to take part in the program. The purpose of this study was to determine the factors that influence student motivation in participating in the international student exchange program. This study uses a descriptive & analytic cross section method. Two hundred and sixty five students were taken using quota sampling via online survey from total population of 481 undergraduate level students in second, third and last year. The results showed that the students' motivation towards the exchange program was high (74.3%) with the most important reason is for career development (86.8%), world enlightenment (5.7%), entertainment (1.5%) and personal growth (6%). However, there were obstacles faced by some students, there are financial barrier (37.7%), lack of confidence in English (35.5%) and lack of family support (8.7%). Other factors that were significantly proven to be related to student motivation were tested using the Wilcoxon sign rank test with $\alpha = 0.05$, there are English ability ($p = 0,000$) and information obtained about student exchange ($p = 0,000$).

Keywords— *motivation, factor, nursing student, student exchange.*

INTRODUCTION

The acceleration of campus development towards internationalization and the need to achieve transcultural nursing competencies are the main reasons for implementing student exchange programs abroad. Student exchange nursing is a program organized by nursing study programs to improve the quality of students, especially in developing the transcultural nursing competence.

Study abroad programs offer great potential to benefit students who take part in this program. Broad discussion among educators about the benefits of study diversification abroad has developed, but students participating in studies abroad may face many obstacles [6]. The results of the study indicate that institutional factors (academic scheduling difficulties, the absence of relevant programs, lack of information) can hinder students from participating in study abroad programs [6].

In the selection process of student exchange conducted by Universitas Muhammadiyah Lamongan, it still showed low interest among students to participate in the program. In 2017, there were only 14 of 216 final year students (6.5%), who took part in the selection process. While in 2018, there were no students interesting in participating in the selection process for the student exchange program.

From some literature review of previous research, there are relatively similar factors throughout the world about the reasons for making decisions in participating in student exchange programs. These factors include the adequacy of information about the program especially at the beginning of the lecture period, interest in foreign cultures, and the availability of academic and family staff that motivate students to take part in the program, while the biggest obstacle is financial capacity and language barriers [5].

From the background stated, the researcher wanted to know how much motivation of nursing students of Universitas Muhammadiyah Lamongan participated in the student exchange program and what factors influenced the motivation of the students. This paper aims to the researchers use the results of this study, together with broader literature, to recommend strategies to increase student participation in study abroad programs.

The purpose of this study was to determine the factors that influence student motivation in participating in the international student exchange program. This research was conducted to meet the needs and demands of the internationalization of the campus so that the results of this study can later be used to recommend strategies to increase student participation in study abroad programs.

LITERATURE REVIEW

Study Abroad

The study abroad is interpreted as a series of learning credit programs; courses and learning experiences that take place abroad [13]. There are short-term programs and long-term programs. Student Exchange is a short-term learning experience abroad involving students less than eight weeks. This learning is the most common type of undergraduate study abroad. Short-term student exchange programs are increasingly popular for a variety of reasons: they are generally more affordable, more attractive to students who may or may not commit to one semester or one year abroad, and allow students in academic programs to be structured like nursing to study abroad without missing their study program [9].

While almost all institutions define short-term studies abroad as programs that last less than one semester, there are many variations in short-term categories. Short-term programs can range from week-long programs conducted during the holidays together with one course, three or four weeks program conducted during the summer, or a longer

program of up to eight weeks that can involve homestays, travel to several sites, and experience of service community or research. Many short-term programs include some of these elements [9].

Short-term programs are appealing to students with limited flexibility due to financial or academic demands. For baccalaureate students, short programs may be appealing to student athletes and others who are concerned about being gone for an extended period. Moreover, short-term trips can help students gain the confidence and desire to participate in longer-term trips. Graduate students may not be eligible for traditional study abroad programs designed for undergraduates, and they may be unable to access international internships due to lack of availability through their school or life responsibilities that prohibit their absence for a semester [16].

Factors that influence student motivation in the student exchange program.

Living life in another country is an important decision that can change lives, so that various reasons and motives including economics, politics, and religion play a role in it. Many models of migration and cultural adaptation have included motivational factors as important determinants of the process of migration and adaptation [7].

Although there is plenty of evidence about the strength of learning experiences abroad, there is far less information about the factors associated with that experience. Some existing studies explain the desires or intentions of students to study abroad. It seems that the same factors influence the choice of goals for students who choose to participate in study abroad programs. There are six factors that influence students' decisions to study abroad: fear of unknown things, curricular problems, financial considerations, commitments, prior travel experiences, and social obligations [4].

Other research found that personality factors such as student achievement motivation, neophilia, migrant personality, and the desire to help distinguish between high motivation and low motivation to study abroad. Their study shows that understanding student characteristics can help educators in developing various types of better promotion programs and strategies to attract a wider range of students to participate in overseas study programs [14].

Literature that examines the motivation of study participants abroad is relatively limited. The results of the two previous studies on student motivation abroad can generally be categorized into four categories of motivation including cross-cultural experiences, academics, future careers and family heritage. While other studies have found that most individuals participating in short-term studies abroad are to gain broader global awareness, add experiences about exciting new cultures, and to have experiences of social interaction and meeting new people [18].

In addition to factors such as costs, historical ties, institutional arrangements, the level of socio-economic development, experience and social ties, goals or geographical preferences can also influence student motivation [18]. The results of other studies show that institutional factors (academic scheduling difficulties, lack of relevant programs, lack of information), can hinder students from participating in study abroad programs [6].

Some student demographic characteristics also influence plans to study abroad. The family's socio-economic status is positively related to the intention to study abroad. Students from families who are eligible for financial assistance outside of school are less likely to plan to study abroad compared with students from higher income families. This shows that finance is not only a barrier, but a lack of resources shapes student expectations about study abroad [20].

The results of study abroad for students vary from internal to external, as evidenced in some literature. The internal results identified were personal development, personal autonomy, and the development of identity, flexibility, and cross-cultural competence. Some of the external results identified were language competence, increased international knowledge, increased motivation in the academic field, and academic and career development [12].

The experience of students about international exchange programs is an interesting resource for clarifying the ideological and cultural relations that underlie the education and health systems [10]. The experience of students undergoing an exchange program is also proven to increase cultural awareness and understanding of the underlying behavior, as well as attitudes and beliefs in their view of the world [3].

The Motivation to Study Abroad (MSA)

An instrument is available to measure students' motivation to participate in study programs abroad. It seems that the study abroad chosen by students, the living arrangements they like, and the activities they choose to engage in and the benefits they get from participation will be influenced by their motivation to travel abroad. Without an instrument to categorize motivation, it is impossible to test the impact of motivation on these program factors. The Motivation to Study Abroad (MSA) instrument has high statistical validity and reliability, meets acceptable reliability criteria, and can be managed easily [1]. First, confirm that you have the correct template for your paper size. This template has been tailored for output on the A4 paper size. If you are using US letter-sized paper, please close this file and download the Microsoft Word, Letter file.

METHODOLOGY

This research used descriptive & analytical research design cross section method and qualitative approach. The sample was 265 students selected by a quota sampling who were willing to fill out an online survey of a total population of 481 nursing undergraduate students at levels 2, 3 and 4.

This research will explore about how much student's motivation towards student exchange programs and their reasons, and what obstacles students face in the program. Another factor that tested was whether it is related to student motivation, they are English ability and information obtained about student exchange. Measurement of student motivation using the MSA instrument (Motivation Study Abroad) with a few modifications, measuring 4 dimensional statements: World Enlightenment, Personal Growth, Career Development, and Entertainment [1]. While the factors that influence motivation are financial, family support, and information obtained in which measured through an open questionnaire. Overall English skills (reading, listening,

speaking, and writing) were assessed through exam scoring and observation for 2 semesters in English lessons.

RESULTS & ANALYSIS

Globalization in the academic context provides the opportunity for sharing knowledge and innovations between institutions in different countries, through the creation of study abroad and academic mobility programs. For nursing students, studying abroad facilitates the development of cultural sensitivity so that they may care appropriately for an increasingly multicultural patient population in their own countries [11]

TABLE I. STUDENT’S MOTIVATION TO EXCHANGE PROGRAM AND THEIR AFFECTING FACTORS

	Frequency	Percent (%)	Cumulative Percent (%)
Motivation			
High	197	74.3	74.3
Moderate	50	18.9	18.9
Low	18	6.8	6.8
Total	265	100.0	100.0
Main motivation			
Career development	230	86.8	86.8
World enlightenment	15	5.7	92.5
Entertainment	4	1.5	94.0
Personal growth	16	6.0	100.0
Total	265	100.0	100.0
Obstacles			
Financial barrier	100	37.7	37.7
Lack of confidence in English	94	35.5	73.2
Lack of family support	23	8.7	81.9
Nothing	48	18.1	100.0
Total	265	100.0	100.0
Information about the program			
Know well	65	24.5	24.5
Maybe know	150	56.6	81.1
Do not know	50	18.9	100.0
Total	265	100.0	100.0
English ability			
Superior	87	32.8	32.8
Advanced	60	22.6	55.5
Intermediate	105	39.6	95.1
Novice	13	4.9	100.0
Total	265	100.0	100.0

Source: author

We know that not all students profit equally from a study abroad experience (Berg & Paige, 2009). They reported on the relationship between intercultural development and variables such as prior language study, prior study abroad experience, class composition, student housing, cultural similarity between home and host cultures, and time spent with host. It is intuitively reasonable that the parameters of a program (e.g., the duration of the program, living arrangements, language of

instruction, magnitude of cultural “distance”, etc.) impact the learning that occurs [2].

As shown in table 1, most student interests or motivations in student exchange programs are actually high (74.3%). Many students considered the importance of joining a student exchange program to add experience, especially in the field of nursing. Motivation that can be interpreted as the strength (energy) of a person can lead to a level of persistence and enthusiasm in carrying out an activity, both from within the individual itself (intrinsic motivation) and from outside the individual (extrinsic motivation). How strong the motivation that an individual has, will determine the quality of the behaviour he performs, both in the context of learning, work and in other life [21]. Likewise, the motivation for this program can also be influenced by motivation that comes from internal and external. Based on the questionnaire, most of the reported internal factors are the personal growth and to prepare for their careers. The career development dimension becomes the highest average score in student motivation. The desire to develop knowledge and experience in the field of nursing is largely the main reason for the dimensions of career development. This reason is proven in research that nursing students with international study experience report a higher competence at graduation [17]

While on the dimensions of personal growth and world enlightenment, both of them got an almost equal average score. The need to increase self-confidence becomes the highest average score in the dimension of personal growth. The willing to know the culture of other countries is the most reason students considering world enlightenment is important. Educational institutions in which their graduate students must have good self-efficacy are also responsible for making programs that can improve student self-efficacy [8]. Because of that, student exchange program is one of the ways to facilitate those needs. Educators should be aware of several nursing issues including the mandate to teach cultural competence training to undergraduate nursing students in their curriculum, the variety of strategies and methods to teach cultural competence training and resources for their students who are interested in study abroad immersion service-learning experience [15]. Therefore, it is both a legal and a moral obligation for nurses to be culturally competent in order to provide high-quality care to diverse patients [19]. Although it just a short- term trips, it can produce significant quantifiable change in students’ cultural adaptability after completing a short- term study abroad trip. Therefore, it is essential that social work educators help produce professionals capable of not only practicing in this environment but continuing to adapt to it as it changes [16].

In the entertainment dimension, almost all students stated that this was a priority with the lowest score. Entertainment in this context is refers to traveling to enjoy a new atmosphere, not including going out drinking, doing some serious partying, and experiencing the local nightlife (clubs, bars, etc.) because these are not in accordance with Indonesian culture.

Based on table 1, the biggest obstacle to the student exchange program is the cost constraint followed by language barriers. It is because the international student exchange program does require much cost. Subsidies from the campus for financing are sometimes still insufficient, especially if the

destination country is a developed country where the cost of living is greater than in Indonesia. Actually, this problem does not only happen in Indonesia but also in all regions. Based on research in several countries, financial barriers are also one of the biggest obstacles to study abroad programs.

Fewer students are also facing the lack of family support. Students from families who are eligible for financial assistance outside of school are less likely to plan to study abroad compared with students from higher income families. This shows that finance is not only a barrier, but lack of resources shapes student expectations about study abroad are [20]. Negative parental attitudes and other family issues also constrain the participation of specific multicultural groups of students in study abroad. Thus for the parents and families of multicultural students, several issues are exist. As indicated, one of the most basic of these issues is fear of racism and discrimination [6].

TABLE II. WILCOXON SIGN RANK TEST FOR STUDENT’S MOTIVATION TO EXCHANGE PROGRAM AND THEIR AFFECTING FACTORS

		N	Mean Rank	Sum of Ranks
motivation – English ability	Negative Ranks	150 ^a	90.29	13544.00
	Positive Ranks	20 ^b	49.55	991.00
	Ties	95 ^c		
	Total	265		
motivation - information	Negative Ranks	154 ^d	89.25	13744.50
	Positive Ranks	21 ^e	78.83	1655.50
	Ties	90 ^f		
	Total	265		

a. motivation < English ability

b. motivation > English ability

c. motivation = English ability

d. motivation < information

e. motivation > information

f. motivation = information

Source: author

In fact, most students are uncertain if they know information about the international student exchange program. This will affect the motivation of students who will consider participation in this program. This is proven by statistical analysis using Wilcoxon sign rank test (Table 2) with $\alpha = 0.05$ obtained z count -9,649 and $\rho = 0,000$ which indicates a relationship about the information received with the level of student motivation in participating in the student exchange program. Some students said they knew about students exchange programs from seniors or from their families who previously had experience following similar programs. Adequate information about the student exchange program will increase student motivation in participating in the program. This is in accordance with a literature review, which states that the experience of having family members who have been abroad is a key factor in motivating students to experience international clinic. Having nursing lecturers involved in global health problems also increases student awareness about global problems and motivates them to have international experience [5].

The ability to speak English was also influence the motivation level of students. It was testified by the statistical analysis using the Wilcoxon sign rank test (Table 2) with $\alpha = 0.05$ obtained z count -10.034 and $\rho = 0.000$ which indicates a relationship between English language skills and the level of student motivation in participating in the student exchange program. It clarifies that with good foreign language skills, students will be more confident that they will also increase their motivation to take part in the exchange program. This is in accordance with a study that conveys the main problem faced by students is that most students think that English needs to understand the language of the teacher and communication with the community. A better understanding of language cannot solve communication problem. The process of communication (including verbal communication) is a source of anxiety and pressure for students that is in accordance with personal, social, and academic characteristics, so that it can indirectly influence student motivation towards the exchange program [10].

CONCLUSION & RECOMMENDATION

The results of this research showed student motivation towards the exchange program was high (74.3%) with the most important reason is for career development (86.8%), world enlightenment (5.7%), entertainment (1.5%) and personal growth (6%). However, there were obstacles faced by some students, there are financial barrier (37.7%), lack of confidence in English (35.5%) and lack of family support (8.7%). Other factors significantly proven to be related to student motivation were tested using the Wilcoxon sign rank test with $\alpha = 0.05$, there are English ability ($p = 0,000$) and information obtained about student exchange ($p = 0,000$). From these results, the researcher recommends that educational institutions increase student motivation in participating in student exchange programs by providing sufficient information about student exchange programs, motivating students about the benefits that they will get if participating in the program, and conducting intensive English language training to optimize the ability of students to master foreign language. It appears that the instructors and advisors who are already involved in international programs are the ones most actively involved in encouraging students. This suggests the significance of making international travel opportunities available to all faculty members, as they will then relay their interest and credibility to their students. This is especially for students whose families have not encouraged international study, whose friends have not studied abroad, and who may experience “low expectations” from their teachers and advisors. The college can consider financial subsidies for students so that students are more enthusiastic in participating in this program.

REFERENCES

1. Anderson, P. H., & Lawton, L. (2015). *The MSA : An Instrument for Measuring Motivation to Study Abroad* (Vol. XXVI).
2. Berg, M. Vande, & Paige, R. M. (2009). The Georgetown Consortium Project : Interventions for Student Learning Abroad. *The Interdisciplinary Journal of Study Abroad*, 18, 1–75.

3. Bohman, D. M., & Borglin, G. (2013). Student exchange for nursing students: Does it raise cultural awareness? A descriptive, qualitative study. *Nurse Education in Practice*, 1–6. <https://doi.org/10.1016/j.nepr.2013.11.006>
4. Bott, J. P., & Mueller, C. B. (2008). FACTORS INFLUENCING STUDY ABROAD DECISIONS AMONG COLLEGE OF BUSINESS STUDENTS. *International Business: Research Teaching and Practice*, 2(1).
5. Brown, M., Appiah, E., & Evans, C. (2016). Should I stay or should I go? A systematic review of factors that influence healthcare students' decisions around study abroad programmes. *Nurse Education Today*, 39, 63–71. <https://doi.org/10.1016/j.nedt.2015.12.024>
6. Brux, J. M., & Fry, B. (2010). Multicultural Students in Study Abroad: Their Interests, Their Issues, and Their Constraints. *Journal of Studies in International Education*, 14(5), 508–527. <https://doi.org/10.1177/1028315309342486>
7. Chirkov, V., Vansteenkiste, M., Tao, R., & Lynch, M. (2007). The role of self-determined motivation and goals for study abroad in the adaptation of international students. *International Journal of Intercultural Relations*, 31, 199–222. <https://doi.org/10.1016/j.ijintrel.2006.03.002>
8. Dinther, M. Van, Dochy, F., & Segers, M. (2011). Factors affecting students' self-efficacy in higher education. *Educational Research Review*, 6(2), 95–108. <https://doi.org/10.1016/j.edurev.2010.10.003>
9. Donnelly-Smith, L. (2009). Global Learning through Short-Term Study Abroad. *Washington*, 11(4), 12–15.
10. Gonzalez, J. S., Ruiz, C. S., & Gutierrez, A. G. (2016). International Appraisal of Nursing Culture and Curricula: A Qualitative Study of Erasmus Students. *Scientifica*, 1–5. <https://doi.org/10.1155/2016/6354045>
11. Karina, A., Oliveira, M. De, & Tuohy, D. (2015). Communication and nursing: a study-abroad student's reflections. *British Journal of Nursing*, 24(21), 1080–1084.
12. Kasravi, J. (2009). *Factors influencing the decision to study abroad for students of color: Moving Beyond the Barriers*. UNIVERSITY OF MINNESOTA. Retrieved from https://conservancy.umn.edu/bitstream/handle/1129/9/55058/Kasravi_umn_0130E_10602.pdf?sequence=1&isAllowed=y
13. Kent-wilkinson, A., Dietrich, M., Luimes, J., Ferguson, L., & Murray, L. (2015). Studying abroad: Exploring factors in influencing nursing students' decisions to apply for clinical placements in international settings ☆. *Nurse Education Today*, 35(8), 941–947. <https://doi.org/10.1016/j.nedt.2015.03.012>
14. Li, Manyu; Olson, Josephine E.; Frieze, I. H. (2013). Students' Study Abroad Plans: the Influence of Motivational and Personality Factors. *The Interdisciplinary Journal of Study Abroad*, 23, 73–89.
15. Long, T. (2014). Influence of International Service-Learning on Nursing Student Self-Efficacy Toward Cultural Competence. *Research Brief*, 474–478. <https://doi.org/10.3928/01484834-20140725-02>
16. Mapp, S. C. (2012). Effect of Short-Term Study Abroad Programs on Students' Cultural Adaptability. *Journal of Social Work Education*, 48(4), 727–737. <https://doi.org/10.5175/JSWE.2012.201100103>
17. Nilsson, J., Carlsson, M., Johansson, E., Egmar, A., & Florin, J. (2014). Nursing in a Globalized World: Nursing Students with International Study Experience Report Higher Competence at Graduation. *Open Journal of Nursing*, 4, 848–858. <https://doi.org/10.4236/ojn.2014.412090>
18. Nyaupane, G. P., Paris, C. M., & Teye, V. (2011). Study Abroad Motivations, Destination Selection and Pre-Trip Attitude Formation. *International Journal of Tourism Research*, 13(October 2010), 205–217. <https://doi.org/10.1002/jtr.811>
19. Repo, H., Vahlberg, T., Salminen, L., Papadopoulos, I., & Leino-kilpi, H. (2016). The Cultural Competence of Graduating Nursing Students. *Journal of Transcultural Nursing*, 1–10. <https://doi.org/10.1177/1043659616632046>
20. Salisbury, M. H., Umbach, P. D., Paulsen, E. M. B., & Pascarella, E. T. (2009). Going Global: Understanding the Choice Process of the Intent to Study Abroad. *Res High Educ*, 50, 119–143. <https://doi.org/10.1007/s11162-008-9111-x>
21. Siagian, S. P., & Luthan, F. (2012). Teori-Teori Motivasi, (5), 1–7.

Factors that Positively Influence to Improve Exclusive Breastfeeding

Mina Yumei Santi

Center of Excellence Innovation of Applied Technology in Public Health,
Health Polytechnic Ministry of Health of Yogyakarta

Yogyakarta, Indonesia

minayumeisanti80@gmail.com, mina.yumei@poltekkesjogja.ac.id or ORCID: 0000-0001-5870-2070

Abstract—Based on World Health Statistics infant mortality rate in the world in 2016 is 41 per 1,000 live births. This value is still quite high if comparing with the Sustainable Development Goals (SDGs) at 25 per 1,000 live births. The optimal breastfeeding under two years of age has the greatest potential for survival of all precaution. An effort to prevent infant mortality is by exclusive breastfeeding. Coverage of exclusive breastfeeding in Special Region of Yogyakarta Province in 2017 amounted to 74.9% is still below from the national target of 80%. The aim of this research was to find the factors that positively influence to improve coverage of exclusive breastfeeding. The research method used analytic with cross-sectional design. The result of the study shows that four factors that positively influence to improve exclusive breastfeeding are mother’s knowledge, age of maternal, counseling and education, and social support of midwives. Knowledge factors have an important role in taking action to give exclusive breastfeeding. Education about breastfeeding is done during pregnancy and during pregnancy visits. Social support of midwives affect the mother’s choice to breastfeeding exclusively. The most common social support is emotional.

Keywords— *exclusive breastfeeding, midwife counselor, early initiation of breastfeeding, infant mortality*

I. INTRODUCTION

The under-five mortality rate in the world in 2016 was 41 per 1,000 live births [1]. This value is still quite large if comparing with the target of the Sustainable Development Goals (SDGs) aims to reduce under-five mortality by at least 25 per 1,000 live births [2]. Provision of breastfeeding optimally can have a major impact on any preventive intervention against child mortality [3]. Increasing duration or quality of breastfeeding could prevent 823,000 child deaths annually [4]. “Maternal under nutrition contributes to 800,000 neonatal deaths annually through small for gestational age births, stunting, and micronutrient” [2].

When the baby only receives breast milk without any additives including water, except for oral rehydration solutions or medicines, the baby is declared to have exclusive breastfeeding. World Health Organization (WHO) and the United Nation International Children’s Emergency Fund (UNICEF) recommend that breastfeeding be started within one hour after birth, continue without food or other fluids for the first six months of life and continue with additional age-appropriate feeding until the 2 year old baby [5]. The exclusive

breastfeeding rate was very low despite a high level of knowledge among mothers [6].

World Health Organization recommends all mothers in the world to give exclusive breastfeeding to their babies until the age of 6 months in order to optimize growth, development and health [7]. “The coverage of exclusive breastfeeding nationwide in 2014 amounted to 52.3% is still below the national target of 80%” [8]. The target of exclusive breastfeeding coverage in Indonesia is 80%, but until 2017 the coverage of exclusive breastfeeding in the Special Region of Yogyakarta only reached 74.90% [9]. The highest percentage of exclusive breastfeeding coverage is in Sleman Regency which is equal to 82.62% while the area that has the lowest exclusive breastfeeding coverage is Yogyakarta City at 66.13%. Figure 1 shows that exclusive breastfeeding coverage in the city of Yogyakarta is lower than the exclusive Yogyakarta Province breastfeeding coverage [9].

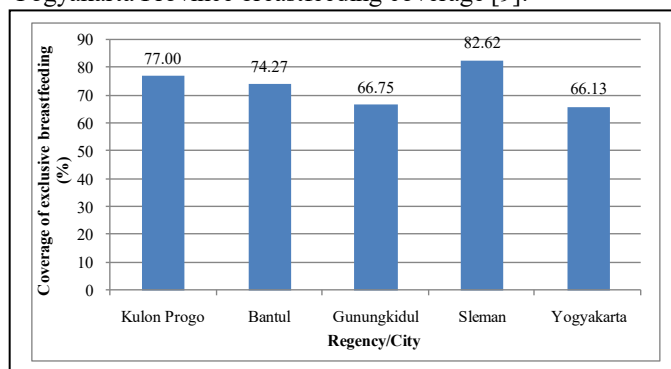

Fig. 1. Coverage of exclusive breastfeeding in Yogyakarta Province in 2017 [9].

The coverage of exclusive breastfeeding in 18 health center in Yogyakarta City can be seen in Table 1. The highest percentage of exclusive breastfeeding coverage is in Health Center Mantrijeron which is equal to 80.41% while the area that has the lowest exclusive breastfeeding coverage is Health Center Umbulharjo I at 35.38%.

TABLE I. COVERAGE OF EXCLUSIVE BREASTFEEDING IN YOGYAKARTA CITY IN 2017 [10]

No.	Health Canter	Baby until 6 month	Exclusive breastfeeding	Percentage (%)
1.	Mantrijeron	245	197	80.41
2.	Kraton	128	72	56.25
3.	Mergangsan	118	92	77.97
4.	Umbulharjo I	424	150	35.38
5.	Umbulharjo II	182	118	64.84
6.	Kotagede I	189	98	51.85
No.	Health Center	Baby until 6 month	Exclusive breastfeeding	Percentage (%)
7.	Kotagede II	98	67	68.37
8.	Gondokusuman I	507	251	49.51
9.	Gondokusuman II	65	48	73.85
10.	Danurejan I	77	53	68.83
11.	Danurejan II	79	39	49.37
12.	Pakualaman	76	38	50.00
13.	Gondomanan	106	46	43.40
14.	Wirobrajan	223	108	48.43
15.	Gedongtengen	134	50	37.31
16.	Ngampilan	26	15	57.69
17.	Jetis	201	155	77.11
18.	Tegalrejo	339	154	45.43
	Average	178.72	97.29	57.56

Based on data obtained from the health profile of the city of Yogyakarta, it can be seen that the health centers that have the lowest exclusive breastfeeding coverage are Health Center Umbulharjo I, which is 35.38% [10]. The low coverage of exclusive breastfeeding is influenced by several factors, one of which is inadequate maternal knowledge about exclusive breastfeeding. Breastfeeding is not just giving a drink by sucking on the nipples, because without proper and regular guidance from health workers it will cause many obstacles in providing breast milk. Some obstacles in breastfeeding are often faced by mothers, including experience, lack of patience in breastfeeding and lack of knowledge in breastfeeding [11].

Based on a study conducted at the Health Center Umbulharjo I, providing counseling on exclusive breast milk to pregnant women have been conducted routinely, but the enthusiasm of the participants is still lacking. Some pregnant women said that counseling is done in a long and tedious time. Counseling about exclusive breastfeeding is carried out on trimester III pregnant women using flipchart media. The aim of this research was to find the factors that positively influence to improve coverage of exclusive breastfeeding.

II. LITERATURE REVIEW

Appropriate counseling and education about breast-feeding can be adopted to achieve changing attitudes, perceptions of knowledge, and practices of breastfeeding. Pregnancy is the right time to start learning about breastfeeding. Pregnancy care is also a good opportunity to increase breastfeeding knowledge in pregnant women [12]. The results of study conducted by Nishimura et al. [13] showed that exclusive breastfeeding relates with maternal age, education during pregnancy, and the

number of attendance at pregnancy visits. Education about breast-feeding should also be done during pregnancy when the mother visits a pregnancy [13]. The success of initiation breastfeeding and exclusive breastfeeding was also related to the acceptance of information about breastfeeding during pregnancy visits and menu delay was also caused by no participation in the class of pregnant women [14]. There was a significant relationship between maternal knowledge of maternal attitudes in breastfeeding [15]. Factors that influence the increase in knowledge about breastfeeding are > 30 years of age and receive education in antenatal clinics [14].

Other factors that affect directly on mothers and infants include [16]: the hospital and health facilities environment, the home and peer environment, the workplace environment, the community environment, and the public policy environment.

“The importance of exclusive breastfeeding in the first 6 month of life is widely recognized, but most mothers still do not reach this goal” [17]. “Less than half of the mothers in our sample reported exclusive breastfeeding in a rural region of Karnataka, India in the first six months, a rate lower than national and state level rates” [13]. The result of a study in Ghana showed that the opportunity to breastfeed a baby in the first hour by being left in contact with the mother's skin can prevent 22% of neonatal deaths. Breastfeeding promotion programs should emphasize early initiation as well as exclusive breastfeeding [18].

III. METHODOLOGY

This research was an analytical survey research with cross sectional design. The study was conducted in the Umbulharjo Health Center I Yogyakarta in April 27th - June 28th. The subjects in this study were all third-trimester pregnant mothers who were willing to become respondents according to the criteria chosen with 46 respondents. Types of social support obtained from midwife include emotional, appreciation, instrumental, information, and social network. Data analysis in this study used uni-variable [19] and bi-variable analysis.

Seven categories of factors that affecting breastfeeding practices include [16]:

- Socio-demographic characteristics of mother and family.
- Structural and social support.
- Health and risk status of mothers and infants.
- Mothers' knowledge, attitudes and skills.
- Aspects of the feeding regime or practices.
- Health services (including hospital and health facilities) organization, policies, and practices.
- Socio-cultural, economic [20], [21], and environmental factors [16].

IV. RESULTS AND ANALYSIS

A. Characteristic of Respondent

Characteristics of 46 respondents based on the mother's age, parity, academic and work status of mother can be seen in Table 2. There are 4 respondents (8.69%) < 20 years old, 82.61% mother's age between 20-35 years old, and 8.69% mother's age > 35 years old. There are 35 respondents (76.09%) with parity 1-2 times and 11 respondents (23.91%) with parity 3-4 times.

TABLE II. CHARACTERISTICS OF RESPONDENTS IN HEALTH CENTER UMBULHARJO I YOGYAKARTA CITY

No.	Category	Frequency	Percentage (%)
1.	Mother age		
	a. < 20 years old	4	8.69
	b. 20-35 years old	38	82.61
	c. > 35 years old	4	8.69
	Total	46	100
2.	Parity		
	a. 1-2 times	35	76.09
	b. 3-4 times	11	23.91
	Total	46	100
3.	Academic		
	a. Junior high school	0	0
	b. Senior high school	39	84.78
	c. Higher education (DI-S2)	7	15.22
	Total	46	100
No.	Category	Frequency	Percentage (%)
4.	Job		
	a. Housewife	28	60.87
	b. Entrepreneur	7	15.22
	c. Laborer	3	6.52
	d. Private employees	4	8.69
	e. Civil servants	3	6.52
	f. Farmer	1	2.17
	Total	46	100
5.	Salary/month		
	a. < IDR 500,000	6	13.04
	b. IDR 600,000-1,000,000	20	43.48
	c. IDR 1,000,000-3,000,000	16	34.78
	d. > IDR 3,000,000	4	8.69
	Total	46	100

B. Factors Influence to Improve Exclusive Breastfeeding

Four factors that positively influence to improve exclusive breastfeeding are mother’s knowledge, age of maternal, counseling and education, and social support of midwives. Counseling can increase knowledge and attitudes of the pregnant women about exclusive breastfeeding. Types of social support obtained from midwife include emotional, appreciation, instrumental, information, and social network. The frequency distribution of midwife’s social support types during antenatal period from 46 respondents can be seen in Table 3. Frequency distribution of maternal choices for exclusive breastfeeding can be seen in Table 4.

TABLE III. FREQUENCY DISTRIBUTION OF MIDWIFE’S SOCIAL SUPPORT TYPES DURING ANTENATAL PERIOD

No.	Types of social support obtained from midwife	Category				Total	Percentage
		Positive		Negative			
		f	(%)	f	(%)	Σf	(%)
1.	Emotional	25	54.4	21	45.7	46	100
2.	Appreciation	24	52.2	22	47.8	46	100
3.	Instrumental	20	43.5	26	56.5	46	100
4.	Information	24	52.2	22	47.8	46	100
5.	Social network	21	45.7	25	54.4	46	100

Based on Table 3, the data shows that majority of respondents received emotional support as many as 25 mothers (54.4%). The least support obtained by respondents during the antenatal period was instrumental support as many as 20 mothers (43.5%) and social network support as many as 21 mothers (45.7%). “The modifiable factors that influence women’s breastfeeding decisions are breastfeeding intention, breastfeeding self-efficacy and social support. Existing midwifery breastfeeding promotion strategies often include social support but do not adequately address attempts to modify breastfeeding intention and self-efficacy” [22].

TABLE IV. FREQUENCY DISTRIBUTION OF MATERNAL CHOICES FOR EXCLUSIVE BREASTFEEDING

No.	Category	Frequency	Percentage (%)
1.	Giving the exclusive breastfeeding	26	56.5
2.	Not giving the exclu-sive breastfeeding	20	43.5
	Total	46	100

Based on Table 4 show that most mothers who plan to choose exclusive breastfeeding aged 0-6 months are 26 mothers (56.5%). Mother’s knowledge of exclusive breastfeeding has a relationship with the success of exclusive breastfeeding in infants. The results showed that there was a significant relationship between the level of knowledge of mothers about breastfeeding and exclusive breastfeeding. Therefore knowledge factors have an important role for a mother in taking actions to give exclusive breastfeeding to her baby [23].

One effort to improve the knowledge of exclusive breastfeeding is by counseling. Counseling can increase the knowledge and attitudes of pregnant women about exclusive breastfeeding [24]. Some media that can be used are teaching aids with counseling demonstration methods. The technique of providing counseling demonstration methods in health

education is considered more capable and more effective in changing one's knowledge or abilities [25]. Counseling with demonstration methods about breastfeeding was able to change the level of ability of breastfeeding mothers in conducting breastfeeding techniques [23]. The influence of the demonstration counseling also affected the level of knowledge of the mother. This is because the demonstration method is considered to be more attractive and stimulates the spirit of mothers learning about exclusive breastfeeding [26]. Chandrashekar [27] stated that the rate of exclusive breastfeeding was higher in mothers who had breastfeeding early initiation. "Despite the higher rates of initiation and exclusive breastfeeding, practices such as pre-lacteal feeds and premature introduction of complementary feeds are of great concern in this urban population" [27].

Research related to the provision of education aimed at pregnant women to increase knowledge of breast milk is quite a lot done, while interventions that are usually carried out to increase maternal knowledge are using various methods and media, starting from the lecture method using media such as leaflets, videos, booklets, tools visual and support groups. Some studies suggest that more research is needed to identify methods and supporting facilities or media that can be used by pregnant women to support success breastfeeding [24], [28].

TABLE V. CROSS TABLE OF MIDWIFE'S SOCIAL SUPPORT IN THE ANTENATAL PERIOD FOR THE CHOICE OF MOTHERS GIVING EXCLUSIVE BREASTFEEDING

Midwife's social support	Mother choice						x ²
	Yes		No				
	f	%	f	%	Σf	%	
Positive	19	67.9	9	32.1	28	100	0.02
Negative	6	33.3	12	66.7	18	100	
Total	25	54.3	21	45.7	46	100	

Based on Table 5, it can be seen that the majority of pregnant mothers who received positive social support from midwives planned to choose to give exclusive breastfeeding for babies aged 0 to 6 months as many as 19 mothers (67.9%) while pregnant mothers who received negative social support from midwives were more likely choose not to give exclusive breastfeeding for babies aged 0-6 months as many as 12 mothers (66.7%). To determine the effect of midwife's social support in the antenatal period on the choice of mothers to give exclusive breastfeeding, the results were obtained by Chi Square Test with a value of 0.02. This value of 0.02 shows a value of <0.05, so it can be concluded that there is an influence of midwife's social support in the antenatal period on the choice of mothers to give exclusive breastfeeding.

The prevalence ratio value is 2.1. The value of the prevalence ratio 2.1 shows that it belongs to the category of more than 1, and then the factors studied are of increased risk. This shows that negative social support from midwives in the antenatal period has 2 times more chance of influencing mothers not to plan giving exclusive breastfeeding to their babies at ages 0-6 months than those who receive positive social support from midwives. The Confidence Interval (CI) from 1.12 to 5.03, included in the category passing number one, can be concluded that the results of this study have a meaningful relationship.

The results of the study prove that midwife's social support obtained during the antenatal period includes emotional support, appreciation, instrumental, information, and social networks. The most support obtained by mothers is emotional support, while the support that is least obtained by mothers during the anti-social period is the support of social networks and followed by instrumental support. From the research obtained, most of the pregnant mothers who plan to give exclusive breastfeeding to their babies aged 0-6 months, but there are still 20 out of 46 pregnant mothers who plan not to give exclusive breastfeeding to their babies. One of the factors causing failure of exclusive breastfeeding is the lack of support from health professionals, especially birth attendants [29]. Midwife's social support in introducing about breastfeeding can begin since pregnancy occurs. Preparing pregnant women who will later breastfeed affects the success of breastfeeding. Education about the importance of breast milk must be obtained by every pregnant woman before birth occurs [30].

Based on the results of the bi-variable test on the influence of midwife's social support in the antenatal period on the choice of mothers to give exclusive breastfeeding the results were 0.02, this figure shows that midwife's social support in the antenatal period affected the choice of mothers to give exclusive breastfeeding. Giving education and support at the time of antenatal have a positive relationship with breastfeeding in the breast and reduce the tendency to suckle with bottles [31]. The most influential interventions on the behaviour of exclusive breastfeeding are a combination of face to face intervention education, support and guidance in the antenatal period [22].

Based on the results of the calculation of prevalence ratios on midwives' social support in antenatal period towards the choice of mothers to give exclusive breastfeeding with the value 2.1, it could be concluded that the factors studied were increase the risk [32]-[34]. Negative social support from midwife in the antenatal period has 2 times more chance of influencing mothers not to plan to give exclusive breastfeeding for their babies at ages 0-6 months than those who receive positive social support from midwife. "Public health practitioners need to understand how local cultural practices influence early initiation of breastfeeding to promote adequate infant weight" [35]. "Breastfeeding counseling by midwives counselor of breastfeeding has not done well, socialization efforts not optimally, lack of human resources and inadequate support facilities" [36]. The average length of time working as breastfeeding counselor's is 43.2 months [37].

Breastfeeding counseling including different Information, Education and Communication (IEC) materials like pamphlets, videos, pictures, discussion and all forms of counseling and peer groups support are considered as the appropriate method of breastfeeding counseling that enhance the breastfeeding outcome [38]. Midwives of breastfeeding counselors who work at the Public Health Centers have additional basic tasks and assignments which is very complex so it is not uncommon to experience difficulties in carrying out each of its tasks properly and has an impact on its performance that is not optimal [39].

V. CONCLUSION AND RECOMMENDATION

Four factors that positively influence to improve exclusive breastfeeding are mother's knowledge, age of maternal, counseling and education, and social support of midwives.

Mother's knowledge about breastfeeding related with the provision of exclusive breastfeeding. Midwife's social support obtained during the antenatal period includes emotional support, appreciation, instrumental, information, and social networks. The most common social support is emotional. Most respondents plan to give exclusive breastfeeding for their babies. The influence of midwife's social support in the antenatal period on the choice of mothers to give exclusive breastfeeding was 0.02 with an alpha value of 0.05.

REFERENCES

- [28] World Health Organization, World Health Statistics 2017: Monitoring health for the SDGs (Sustainable Development Goals), World Health Organization, 2007. <http://www.undp.org/content/undp/en/home/sustainable-development-goals/goal-5-gender-equality.html#targets>
- [29] Z. A. Bhutta, J. K. Das, A. Rizvi, M. F. Gaffey, N. Walker, and S. Horton, "Evidence-based interventions for improvement of maternal and child nutrition: What can be done and what cost?," *Lancet*, vol. 382, pp. 452-477, 2013. [https://doi.org/10.1016/S0140-6736\(13\)60996-4](https://doi.org/10.1016/S0140-6736(13)60996-4).
- [30] N. C. Rollins, N. Bhandari, N. Hajeerbhoy, S. Horton, C. K. Lutter, and J. C. Martines, "Why invest and what it will take to improve breastfeeding practices?," *Lancet*, vol. 387, pp. 491-504, 2016. [https://doi.org/10.1016/S0140-6736\(15\)01044-2](https://doi.org/10.1016/S0140-6736(15)01044-2).
- [31] UNICEF, World Health Organization, 1000 Days, and Alive & Thrive, Nurturing the Health and Wealth of Nations: The Investment case for Breastfeeding, 2016. <https://www.who.int/nutrition/publications/infantfeeding/global-bf-collective-investmentcase/en/>.
- [32] A. K. A. Diji, V. Bam, E. Asante, A. Y. Lomotey, S. Yeboah, and H. A. Owusu, "Challenges and predictors of exclusive breastfeeding among mothers attending the child welfare clinic at a regional hospital in Ghana: A descriptive cross-sectional study," *Int. Breastfeed. J.*, vol. 12, pp. 1-7, 2017. <http://doi.org/10.1186/s13006-017-0104-2>.
- [33] U. O. Uchendu, A. N. Ikefuna, and I. J. Emodi, "Factors associated with exclusive breastfeeding among mothers seen at the University of Nigeria Teaching Hospital," *South African Journal of Child Health (SAJCH)*, vol. 3 (1), pp. 14-19, 2009. <https://www.ajol.info/index.php/sajch/article/view/50529>.
- [34] World Health Organizations (WHO), Exclusive breastfeeding for six months best for babies everywhere, World Health Organizations, 2011. https://www.who.int/mediacentre/news/statements/2011/breast-feeding_20110115/en/.
- [35] M. Y. Santi, "Upaya Peningkatan Cakupan ASI Eksklusif dan Inisiasi Menyusu Dini (IMD)," *Jurnal Kesmas Indonesia*, vol. 9 (1), pp. 69-80, 2017. <http://jos.unsoed.ac.id/index.php/kesmasindo/article/view/230/199>.
- [36] Dinas Kesehatan Provinsi Daerah Istimewa Yogyakarta, Profil Kesehatan DIY 2017, Dinas Kesehatan Provinsi Daerah Istimewa Yogyakarta, Yogyakarta, 2017.
- [37] Dinas Kesehatan Kota Yogyakarta, Profil Kesehatan Kota Yogyakarta 2017, Dinas Kesehatan Kota Yogyakarta, Yogyakarta, 2017.
- [38] S. L. D. Astuti and A. Surasmi, "Pengaruh penyuluhan kesehatan tentang menyusui dengan metode demonstrasi terhadap kemampuan ibu menyusui di rumah bersalin wilayah Banjarsari, Surakarta," *Jurnal Terpadu Ilmu Kesehatan*, vol. 5 (2), pp. 110-137, 2016. <http://jurnal.poltekkes-solo.ac.id/index.php/Int/article/view/235>.
- [39] E. Wahyutri, M. Jasmawati, K. K. Dharma, and M. Ratnawati, "The effect of infant feeding planning education on nutrition and breastfeeding knowledge, mothers attitude, and husband support to expectant mother," *J. Nurs Educ. Prac.*, vol. 8 (1), pp. 87-93, 2018. <https://doi.org/10.5430/inpep.v8n1p87>.
- [40] H. Nishimura, K. Krupp, S. Gowda, V. Srinivas, A. Arun, and P. Madhivanan, "Determinants of exclusive breastfeeding in rural South India," *Int. Breastfeed. J.*, vol. 13 (40), 2018. <https://doi.org/10.1186/s13006-018-0178-5>.
- [41] H. Raheel and S. Tharkar, "Why mothers are not exclusively breastfeeding their babies till 6 months of age? Knowledge and practices data from two large cities of the Kingdom of Saudi Arabia," *Sudan J. Paediatr.*, vol. 18 (1), pp. 28-38, 2018. <https://www.ncbi.nlm.nih.gov/pmc/articles/PMC6113778/>.
- [42] H. Saied, A. Mohamed, A. Suliman, and W. Al Anazi, "Breastfeeding knowledge, attitude, and barriers among Saudi women in Riyadh," *J. Nat. Sci. Res.*, vol. 3 (12), pp. 6-13, 2013. <https://www.iiste.org/Journals/index.php/JNSR/article/viewFile/8501/8440>.
- [43] D. J. Hector, L. King, and K. L. Webb, "Factors affecting breastfeeding practices: Applying a conceptual framework," *NSW Public Health Bull.*, vol. 16 (3-4), pp. 52-55, 2005. <https://doi.org/10.1071/NB05013>.
- [44] E. Albernaz, C. G. Victora, H. Haisma, A. Wright, and W. A. Coward, "Lactation counseling increases breastfeeding duration but not breast milk intake as measured by isotopic methods," *J. Nutr.*, vol. 133 (1), pp. 205-210, 2003. <https://dx.doi.org/10.1093/jn/133.1.205>.
- [45] K. M. Edmond, C. Zandoh, M. A. Quigley, S. Amenga-Etego, S. Owusu-Agyei, and B. R. Kirkwood, "Delayed breastfeeding initiation increases risk of neonatal mortality," *J. Pediatr.*, vol. 117 (3), pp. 380-386, 2006. <https://dx.doi.org/10.1542/peds.2005-1496>.
- [46] G. Sugiyanto and S. Malkhamah, "Determining the maximum speed limit in urban road to increase traffic safety," *Jurnal Teknologi (Sciences and Engineering)*, vol. 80 (5), pp. 67-77, 2018. <https://doi.org/10.11113/jt.v80.10489>.
- [47] G. Sugiyanto, P. B. Santosa, A. Wibowo, and M. Y. Santi, "Analysis of hub-and-spoke airport networks in Java Island, Indonesia based on cargo volume and freight ratio," *Procedia Eng.*, vol. 125, pp. 556-563, 2015. <http://dx.doi.org/10.1016/j.proeng.2015.11.061>.
- [48] G. Sugiyanto, "The effect of congestion pricing scheme on the generalized cost and speed of motorcycle," *Walailak J. Sci. & Tech.*, vol. 15 (1), pp. 95-106, 2018. <http://wjst.wu.ac.th/index.php/wjst/article/view/2347>.
- [49] S. Meedya, K. Fahy, and A. Kable, "Factor that positively influence breastfeeding duration to 6 month: a literature review," *Women Births*, vol. 23 (4), pp. 135-145, 2010. <https://dx.doi.org/10.1016/j.wombi.2010.02.002>.
- [50] D. Lestari, R. Zuraida and T. A. Larasati, "Related mother's knowledge level on breast milk and work in the provision of exclusive breastfeeding Fajar Bulan Village Lambar Regency," *Med. Journal of Lampung University*, vol. 2 (4), pp. 88-99, 2013. <http://joke.kedokteran.unila.ac.id/index.php/majority/article/download/66/65>.
- [51] Hendra, T. Rumijati, and Y. Sarinengsih, "Pengaruh penyuluhan ASI eksklusif terhadap pengetahuan ibu hamil di Desa Sindangraja, Kecamatan Sukaluyu, Kabupaten Cianjur Tahun 2013," *Bhakti Kencana Media*, vol. 4, pp. 1-74, 2014. <http://ejournal.stikesbhaktikencana.ac.id/file.php?file=jurnal&id=573&cd=0b2173ff6ad6a6fb09c95f6d50001df6&name=pengaruh%20penyuluhan%20ASI.pdf>.
- [52] S. H. W. Sulistyawati, "The differences of effectiveness of health education method for audiovisual Basic Life Support (BLS) with demonstration of live saving ability to students of nursing science FIK Kadiri University," *Journal of Nursing Care & Biomolecular*, vol. 2 (1), 2017.
- [53] W. A. R. Merdhika, "Pengaruh penyuluhan ASI eksklusif terhadap pengetahuan ibu tentang ASI eksklusif dan sikap ibu menyusui di Kecamatan Kanigoro, Kabupaten Blitar," *Teknologi dan Kejuruan*, vol. 37, pp. 65-72, 2014.

- [54] T. S. Chandrashekar, H. S. Joshi, S. Binu, P. R. Shankar, M. S. Rana, and U. Ramachandran, "Breastfeeding initiation and determinants of exclusive breastfeeding a questionnaire survey in an urban population of western Nepal," *Public Health Nutr.*, vol. 10 (2), pp. 192-197, 2006. <https://dx.doi.org/10.1017/S1368980007248475>.
- [55] K. Wijayanti, T. Indrayana, and Kuswanto, "Mother's knowledge and level of family support toward exclusive breastfeeding practice," *Int. J. Sci. Basic Appl. Res.*, vol. 29 (1), pp. 57-63, 2016. <http://gssrr.org/index.php?journal=JournalOfBasicAndApplied&page=article&op=download&path%5B%5D=6047&path%5B%5D=2994>.
- [56] F. D. Permana, "Faktor-faktor penyebab kegagalan pemberian ASI eksklusif pada ibu yang tidak bekerja Kecamatan Mranggen Kabupaten Demak Tahun 2006," Undergraduate thesis, Diponegoro University Semarang, 2006.
- [57] S. E. Arisna, S. Hastuti, and M. Y. Santi, "Social support midwife during the antenatal period against mother's choice to provide exclusive breastfeeding," *Midwifery Department, Health Polytechnic Ministry of Health of Yogyakarta*, pp. 1-11, 2014.
- [58] A. S. McMillan, J. Barlow, and M. Redshaw, *Birth and beyond: a review of the evidence about antenatal education*, Department of Health Great Britain, 2009.
- [59] R. Handoko, *Statistik kesehatan belajar mudah teknik analisis data dalam Penelitian kesehatan plus aplikasi software SPSS*, Mitra Cendikia Press, 2012.
- [60] G. Sugiyanto, A. Fadli, and M. Y. Santi, "Identification of black spot and equivalent accident number using upper control limit method," *ARNP Journal of Engineering and Applied Sciences*, vol. 12 (2), pp. 528-535, 2017. http://www.arnpjournals.org/jeas/research_papers/rp_2017/jeas_0117_5650.pdf.
- [61] G. Sugiyanto, "The cost of traffic accident and equivalent accident number in developing countries (case study in Indonesia)," *ARNP Journal of Engineering and Applied Sciences*, vol. 12 (2), pp. 389-397, 2017. http://www.arnpjournals.org/jeas/research_papers/rp_2017/jeas_011_5631.pdf.
- [62] H. M. Wren, N. W. Solomons, A. M. Chomat, M. E. Scott, and K. G. Koski, "Cultural determinants of optimal breastfeeding practices among indigenous Mam-Mayan women in the Western Highlands of Guatemala," *J. Hum. Lact.*, vol. 31 (1), pp. 172-184, 2015. <https://doi.org/10.1177/0890334414560194>.
- [63] M. Y. Santi, A. Margawati, and A. Mawarni, "Faktor Komunikasi dan Ketersediaan Sumber Daya dalam Implementasi Konseling Air Susu Ibu oleh Bidan Konselor ASI," *Jurnal Kesmas Indonesia*, vol. 7 (3), pp. 190-208, 2015. <http://jos.unsoed.ac.id/index.php/kesmasindo/article/view/131/120>.
- [64] M. Y. Santi, NurDjanah, and Margono, "Hubungan Beban Kerja dengan Kinerja Bidan Konselor ASI di Provinsi Daerah Istimewa Yogyakarta," *Jurnal Kesmas Indonesia*, vol. 8 (2), pp. 29-43, 2016. <http://jos.unsoed.ac.id/index.php/kesmasindo/article/view/155>.
- [65] A. Chimariya, *Breastfeeding counseling in maternity health care clinic: The mothers experiences of supports received from their spouses*, Master's Thesis, Health Promotian in Nursing Science, Faculty of Health Sciences, University of Eastern Finland, 2014. http://epublications.uef.fi/pub/urn_nbn_fi_uef20140588/urn_nbn_fi_uef20140588.pdf.
- [66] M. Y. Santi, "Implementasi Kebijakan Pemberian Air Susu Ibu Eksklusif melalui Konseling oleh Bidan Konselor," *Kesmas Jurnal Kesehatan Masyarakat Nasional*, vol. 8, pp. 346-352, 2014. <http://dx.doi.org/10.21109/kesmas.v8i8.403>.

Effect of Behavior and Environment on Common Cold in Children

1st Arfah Husna
Public Health Faculty
Teuku Umar University
Aceh Barat, Aceh, Indonesia
arfahhusna@utu.ac.id

2nd Afriani Maifizar
Political and Social Faculty
Teuku Umar University
Barat, Aceh, Indonesia
afriani.maifizar@utu.ac.id

3rd Enda Silvia Putri
Public Health Faculty
Teuku Umar University
Aceh Barat, Aceh, Indonesia
endasilviaputri@utu.ac.id

4th Marniati
Public Health Faculty
Teuku Umar University
Aceh Barat, Aceh, Indonesia
marniati@utu.ac.id

Abstract— Introduction common cold is a disease caused by rhinovirus which will heal by itself because the life span of the virus is limited. Cases of cold commissions in Meureubo puskesmas in 2018 were 147 cases. The purpose of the study was to determine the effect of behaviour and environment on the incidence of Common Cold in children in the Work Area of Meureubo Health Center in West Aceh Regency. The method of researched was an analytical survey with cross sectional design, a population of 60 people and a sample of 60 people which is a total sampling, the data were analyzed using simple linear regression analysis. The results of the study have an influence between behaviour and environment Common Cold in children. The conclusion is the influence between behaviour, and environment on Common Cold in children. The Recommended to the Meureubo Health Center are expected to be able to provide information to the community about Common Cold disease, how to prevent and treat Common Cold in children

Keywords—common cold, behaviour, environment, children

INTRODUCTION

One symptom of the disease that is most often treated by the people themselves is a symptom of diseases associated with respiratory problems, namely the Common Cold (Tjay and Rahardja, 2012). Common Cold is a symptom of respiratory problems characterized by coughing, sneezing, nasal congestion, sore throat, mild fever and headaches. These disorders greatly disrupt daily activities (Azwar, 2013). Common Cold is a disease caused by rhinovirus which will heal by itself because the life span of the virus is limited, or referred to as a self-limiting disease. In fact, anti-viral drugs are needed to stop the symptoms of this disease. However, because antiviral has not been found especially for this rhinovirus, only symptoms that appear are treated if it is felt to disturb the patient. So, the treatment is only to relieve or eliminate symptoms (symptomatis), without killing the causative virus (Puspitasari, 2012). based on the results (Basic

Health Research (Riskesdas), 2018) prevalence common cold in Indonesia around 25.0% and 13.8% of cases after being diagnosed definitively by a doctor. Whereas in the Province of Central Java prevalence common colds around 28.0% and in Surakarta City with 4.0% of them have been diagnosed definitely by doctors. This prevalence is highest in infants and toddlers. Common cold in toddlers in Indonesia is estimated at 3 to 6 times per year, this means that an average toddler gets a cold cough attack 3 to 6 times a year. Efforts to deal with common cold earlier are expected to prevent complications in infants that can have fatal consequences such as pneumonia, in addition to other complications such as Otitis Media Akuta (OMA), and mastoiditis (Ministry of Health, 2018).

Based on data from the Aceh Health Office the number of cases of cold common in 2015 was 5,237 cases, the number of cases of cold common in 2016 was 7,423 cases, the number of cases of cold commissions in 2017 was 8,952 cases (Health Office of Aceh, 2016).

Based on West Aceh Health Office data, the number of cases of cold common in 2015 was 2,509 cases, the number of cases of cold common in 2016 was 3,099 cases, the number of cases of cold common in 2017 was 4,298 cases (West Aceh Health Office, 2017).

Based on data from Meureubo Community Health Center, the number of cases of cold common in 2017 was 216 cases, the number of cases of cold common in 2018 was 147 cases (Meureubo Health Center, 2017).

Based on the initial survey in the working area of the Meureubo Community Health Center where interviews with 4 mothers were found in the field, where 1 mother stated that she was unaware of the causes of cold commissions and symptoms, they said that it was a common cold without follow up. Mothers only give ordinary medicines purchased at the pharmacy. Then 1 mother is still ignoring the prevention of the child where the mother is normal when her child experiences sore throats, coughs and cold sores in the head of fever, and nasal congestion. Mothers assume that children only exposed to regular fever without responding wisely should take the child to the puskesmas or doctor. Furthermore, 1 mother does not act quickly when her child experiences

symptoms of cold common, this I know from the statement of the mother where when the child coughs up a cold and sore throat the mother only gives fever medicine that is already at home and compresses the child. Furthermore, 1 mother stated that her child was left to play with friends outside the home, where sometimes there were friends of children who had fever. Based on the background above, the author would like to examine further about "Factors Affecting Common Cold in Children in the Work Area of Meureubo Health Center in West Aceh Regency".

LITERATURE REVIEW

Common Cold

Common cold is a nasopharyngeal and nasal primary infection that often affects infants and children. This disease can also affect adults but has different characteristics. In infants and children, this disease tends to be more severe because the infection includes the paranasal sinus area, middle ear and nasopharynx accompanied by high fever, whereas in adults only limited and does not cause high fever (Ngastiyah, 2012).

Symptoms

The most common symptom in this disease is nasal congestion, secreting from the nose and coughing. Common cold is included in a disease that does not require medication or self-limited disease if the period is still less than 10 days. Therefore treating flu symptoms (nasal congestion) is more effective than treating the infection. The use of antibiotics to treat common cold is not effective because the etiology is a virus. (Dicpinigaitis PV, et al, 2014)

Etiology and Pathophysiology

The most common pathogenic virus that causes rhinitis is rhinovirus, although it can be caused by other viruses. Rhinovirus has more than 100 serotypes and is a cause of 30-50% rhinitis per year. (Naning R, Triasih R, Setyati A. 2012) Other viruses that cause rhinitis include: coronavirus, RSV, human metapneumovirus, influenza, parainfluenza, adenovirus, enterovirus and bocavirus. (Turner RB, Hayden GF. 2011)

Factors Affecting Common Cold

Behaviour

According to Notoatmodjo (2012), an attitude has not been automatically manifested in an Behaviour (overt behavior). To realize attitudes into real actions, supporting factors are needed or a possible condition, including facilities. Besides the facilities factor, a support factor from other parties is also needed.

Environment

Something that is outside or around living things. Environment is a complex system where various factors influence reciprocally with each other with the community (Notoatmodjo, 2012).

METHODOLOGY

Before This study uses a quantitative analytical method with a cross sectional approach. The population in this study were all mothers who had children 6-10 years in the Working Area

Identify applicable funding agency here. If none, delete this text box.

of the Meureubo Community Health Center in West Aceh Regency, which were 60 people. The sample in this study were all mothers who had children 6-10 years in the Working Area of the Meureubo Health Center in West Aceh Regency, namely 60 people (total sampling). This research was carried out in the Meureubo Meulaboh Health Center District of West Aceh District in February 2018. The variables in the study were Knowledge, Attitudes, Behaviour and Environment. The tools used for collecting data in this study were questionnaires. The ethics of this study were researchers made informed consent (consent sheet to become respondents), anonymity (confidentiality of name / identity) and confidentiality (confidentiality of results).

RESULT AND ANALYSIS

Univariate analysis

Univariate Analysis is to see the characteristics of respondents displayed in the form of frequency distribution tables.

Table 1 : Frequency Distribution Based of Common Cold in Children In The work Area of Meureubo Health Center in West Aceh Regency in 2018

Number	<i>Common Cold</i>	<i>Frequency</i>	<i>Percentage</i>
1	Light	22	36,7
2	Weight	38	63,3

Table 2 : Respondent Frequency Distribution Based on Respondent Behaviour Affecting Common Cold in Children In The work Area of Meureubo Health Center in West Aceh Regency in 2018

Number	<i>Behaviour</i>	<i>Frequency</i>	<i>Percentage</i>
1	There is	24	40
2	There is no	36	60

Table 3 : Respondent Frequency Distribution Based on Respondent Behaviour Affecting Common Cold in Children In The work Area of Meureubo Health Center in West Aceh Regency in 2018

Number	<i>Environment</i>	<i>Frequency</i>	<i>Percentage</i>
1	Good	28	46,7
2	Not Good	32	53,3

1. *Bivariate Analysis*

Table 4 : simple Regression Analysis of Behaviour

Model	Unstandardized Coefficients		Standardized Coefficients
	B	Std. Error	Beta
(Constant)	.111	.062	
Behaviour	.639	.098	.649

Dependent Variable: Common Cold

Table 5 : simple Regression Analysis of Environment

Model	Unstandardized Coefficients		Standardized Coefficients
	B	Std. Error	Beta
(Constant)	.125	.073	
Environment	.518	.107	.536

Dependent Variable: Common Cold

Effect of Behaviour on Common Cold in Children

Based on the results of the X3 regression coefficient (action) of 0.639, it means that there is an influence between the Behaviour on Cold Commodity in Children in the Work Area of Meureubo Health Center in West Aceh Regency, as evidenced by a significant value = 0.000 α 0.05

Based on observations in the field researchers see that the respondents who take precautionary measures against Common Cold in children and their children experience mild Common Cold because mothers have tried to make prevention such as children are prohibited from playing rain, children should not eat fried foods, children may not play outside with friends friend who is Common Cold. However, the respondent's children still experience Common Cold because the immune system of children who are weak and children are quickly affected by the disease, this is the respondents know from the results of examinations with health workers when their children are taken for treatment.

Whereas respondents who did not take preventive measures and their children experienced Common Cold weight because when children experience Common Cold their mother do not directly bring their children to medical treatment but only give medicines at home. This makes the child experience severe Common Cold

According to Notoatmodjo (2012), an attitude has not been automatically manifested in an behaviour (overt behavior). To realize attitudes into real behaviour, supporting factors are needed or a possible condition, including facilities. Besides the facilities factor, a support factor from other parties is also needed.

This research is supported by Maula's research (2016), the results of the study state that there is an effect of behaviour

with the incidence of cold commond in Sumedang District in evidence with a value of p Value = 0.031.

Environmental Effects on Common Cold in Children

Based on the X4 regression coefficient (environment) of 0.518, it means that the environment obtained by the officer has an effect on Common Cold in Children in the Work Area of Meureubo Health Center in West Aceh Regency, as evidenced by a significant value = 0.000 α 0.05.

Based on observations in the field, the researchers saw that respondents who were in good environment and their children experienced mild cold because the mother's environment was clean and the children around the respondent's residence did not experience Common Coldakan but when their children were left to their parents or grandmothers the children were allowed to play rain and make children experience Common Cold

Where as respondents who have a poor environment and their children experience Common Cold weight because in the respondent's neighborhood the children are allowed to play as they wish without any restrictions from parents, mother is allowed to play rain and heat

Something that is outside or around living things. Environment is a complex system where various factors influence reciprocally with each other with the community (Notoatmodjo, 2012).

This research is supported by the study of Palumulo (2012). The results of the study state that there are environmental influences, especially the cleanliness of the environment with Common Cold disease in toddlers in the Gorontalo City Health Center working area in 2012 with evidence p value = 0.031.

ACKNOWLEDGMENT

Thankyou to Head of Meurebo Community Health Center, Aceh Barat who provided their support so that t he research was completed.

REFERENCES

1. Azwar, B., 2013, *Bijak Mengkonsumsi Obat Flu*, 2-17, PT. Kawan Pustaka, Depok.
2. Cohen MTHD, Vodicka TA, Blair PS, Buckley DI, Heneghan C, Hay AD. 2013. Duration of symptom of respiratory tract infections in children: systematic review. *BMJ*. 2013; 347:f7027.
3. Department of Child and Adolescent Health and Development World Health Organization. 2011. *Cough and cold remedies for the treatment of acute respiratory infections in young children. Switzerland*. Worl Health Organization.
4. Enggar. 2017. *Pengaruh Pengetahuan Dan Sikap Ibu Yang Mempunyai Anak Balita Dengan Kejadian Penyakit Infeksi Saluran Pernapasan Akut (ISPA) di Puskesmas Tinggede*. Jurnal kesehatan tadulako vol. 3 no. 2, juli 2017 : 1-75 ISSN. 2653-3241. Akademi kebidanan palu sulawesi tengah
5. Kastiano. 2017. *Faktor-faktor yang berhubungan dengan sikap orangTua dalam penatalaksanaan kejang demam pada Balita usia 1-5 tahun di rumah sakit cito karawang tahun 2016*. Jurnal Ilmiah Keperawatan

- STIKes Medika Cikarang. vol. 2 no 3, 2017, ISSN. 2346-3147.
6. Maula. 2016. *Pengaruh tindakan dengan Terapi Herbal dan Alternatif pada Flu Ringan atau ISPA non-spesifik*. Majalah Farmasetika, Vol.1 No.2, 2016 e-ISSN : 2528-0031. Fakultas Farmasi Universitas Padjadjaran, Sumedang, Jawa Barat, Indonesia.
 7. Naning R, Triasih R, Setyati A. 2012. *Rinitis. Dalam: Rahajoe NN, Supriyatno B, Setyanto DB penyunting. Buku Ajar Respirologi Anak Edisi I*. Badan Penerbit IDAI. h.278-87.
 8. Palumulo. 2012. *Pengaruh Sanitasi Lingkungan Dengan Kejadian Penyakit Common Cold Pada Balita Di Wilayah Kerja Puskesmas Tamalate Kota Gorontalo Tahun 2012*. Jurnal Kesehatan, Vol 1 No. 2. ISSN 2563-2431. Universitas Negeri Gorontalo.
 9. Puspitasari, I., 2012, *Cerdas Mengenali Penyakit dan Obat*, 13 – 20, Gajah Mada University Press, Yogyakarta.
 10. Roberts G, Xatzipsalti M, Borrego LM, Custovic A, Halken S, Hellings PW, et al. 2013. *Paediatric rhinitis: position paper of the European academy of allergy and clinical immunology*. Allergy. 68:1102-16.
 11. Turner RB, Hayden GF. 2011. The common cold. In: Kliegman RM, Stanton BF, St.Geme JW, Schor NF, Behrman RE editor. *Nelson Textbook of Pediatrics*. 19th ed. Philadelphia. Elsevier Saunders. p.1434-36.

User Acceptance in Using the Primary Health Care Management Information System: Literature Review

Fauzan Kurniawan

Master of Hospital Management Universitas Muhammadiyah Yogyakarta fauzankurniawan95@gmail.com

Arlina Dewi

Master of Hospital Management Universitas Muhammadiyah Yogyakarta dewi_koen@yahoo.co.id

Abstract-Background: Health information system users have an influence on the efficiency of a system in providing health services so that it can increase the value of patient safety. We conducted a literature review in knowing how the user acceptance in using a health information system. **Method:** Literature review is conducted by looking for articles from 2008 to 2018 using a database from PubMed. Articles are accepted in this study if they examine the influence of user attitudes on the running of health information systems in hospitals and primary services. Sorting articles through abstracts and free full text articles. **Results:** A total of 148 articles on the influence of user acceptance towards health information systems, 25 articles included inclusion criteria. Various user acceptance assessment models such as the Technology Acceptance Model (TAM), and the Unified Theory of Acceptance and Use of Technology (UTAUT) are used in a number of these articles. Most articles explain that cooperative users can make health information system become efficient, but several environmental and personal factors can influence the system. **Conclusion:** Making an efficient health information system, a cooperative user attitude and acceptance is needed. The existence of environmental and personal factors is an obstacle in the system, so it needs an effort from the hospital management and primary services to improve the quality of existing resources to achieve the main goal of improving patient safety. Future research is needed to examine how the hospital or primary care management can increase existing resources.

Keywords : *Health Information System, Primary Health Care, user attitude, patient safety*

I. INTRODUCTION

Based on the Permenkes No. 75 in 2014, The Indonesian Primary Health Care (PHC) has a task that provide a health care based on the individual health care and public health care which focused on the promotive and preventive activity. To perform the task, Indonesian PHC must have strategies, one of the strategies is developing the PHC management information system which has aim to provide informations which needed by health care giver, PHC management, and health department to manage patients [1].

Health information system users have an influence on the efficiency of a system in providing health services so that it can increase the value of patient safety. However, there are

several factors that affect the users in using management information system. The factors are some users are not discipline and delay to input the data, a minimum supervision, do not have enough time, and lack of skill [2]. So, we conducted a literature review in knowing how the user acceptance in using a health information system.

II. RESEARCH METHOD

This study is a literature review on health information systems studies in Indonesia from 2008 to 2018. We searched PubMed for relevant papers in English. Keywords which used in this study were “user acceptance”, “health information system”, “primary health care”, “public health care”, “urban area”, “rural area”, “Indonesia”. We used two different strategies using the advanced search function to search relevant studies in the PubMed database. We used “OR” and “AND” to combine each keyword. Sorting articles through abstracts and free full text articles. The inclusion criteria were an original study reported on the paper, paper evaluated user acceptance aspect of health information system, evaluated system used in hospital and primary health care facilities. The exclusion criteria were paper which did not include the inclusion criteria.

III. RESULTS

A total of 148 articles were retrieved from PubMed database. After removing irrelevant studies from abstract and free full text, there were 25 studies included inclusion criteria. Various user acceptance assessment models: Technology Acceptance Model (TAM), and the Unified Theory of Acceptance and Use of Technology (UTAUT) are used in a number of these studies [3]. Most articles explain that cooperative users can make health information system become efficient, but several environmental and personal factors can influence the system. Several factors that affect the acceptance in using health information system: administrative and medication errors were decreased, working and human resources costs were reduced, security of information of patients and documents were increased, data accessibility were increased, quality and efficiency of services and medical care were improved, task time were reduced and costs imposed to the health care provider were increased [4].

IV. DISCUSSION

This study evaluating the acceptance in using health information system that has several benefits such as

providing quality service and medical care, increasing accuracy and accessibility, reducing errors and tasks time [4]. But, there are several negative effect to the user acceptance, such as increasing the cost of health care provider to maintenance the system, and requiring more time to adopt a new system. The concern of the benefit in using health information system is to increase patient safety by reducing the medical errors. When the health care provider not using the information system, there were several reports that medical errors were increased [5]. By using the health information system, medical and health care staffs are believed that the systems can reduce errors. Medical errors that can be reduced are miscommunication between staffs to gather patient information, workload of the medical staffs, and illegibility of the staffs' handwriting [6].

There are several factors that affect the implementation of health information system in rural area. The factors were regrouped into seven groups, such as the characteristics of health care provider, characteristics of medical practice, voluntariness of use, performance expectancy, effort expectancy, social influence, facilitating or inhibiting conditions [3,6]. These factors are explained as health information in primary health care was poorly utilized and unless there were any corrective measures made, the effectiveness and service quality of health facilities might be greatly affected. Another factors such as technology access were limited, less supportive supervision, poor awareness about data management, and input data were depend on the location of infrastructure and geographical [4,6,7,8]. Immediate actions to improve health information system data are needed for these problems such as training of healthcare workers, health information system data use workshop, managing data information of user guideline, awareness on the importance of health information management system data use are made, to increase the user acceptance and quality of healthcare services [6,9].

I. CONCLUSION

Making an efficient health information system, a cooperative user attitude and acceptance is needed. The existence of environmental and personal factors is an obstacle in the system, so it needs an effort from health care management and primary services to improve the quality of existing resources in order to achieve the main goal to improve patient safety. Future research is needed to examine how the health care, especially primary care management can increase existing resources.

REFERENCES

- [1].Aulia, N. R., 2017. Faktor Human, Organization, dan Technology dalam Penggunaan Aplikasi SIMPUS untuk Pendaftaran Pasien di Puskesmas Mulyorejo Surabaya. *The Indonesian Journal of Public Health*, 12(2), pp. 237-248.
- [2].Handayani, P. et al., 2016. Acceptance Model of a Hospital Information System. *International Journal of Medical Informatics*.
- [3].Kim, S., Lee, K.-H., Hwang, H. & Yoo, S., 2016. Analysis of the Factors Influencing Health Care Professionals' Adoption of Mobile Electronic Medical Record (EMR) using the Unified Theory of Acceptance and Use of Technology (UTAUT) in a Tertiary Hospital. *BMC Medical Informatics and Decision Making*, 16(12).
- [4].Shiferaw, A., Zegeye, D., Assefa, S. & Kindie, M., 2017. Routine Health Information System Utilization and Factors Associated thereof Among Health Workers at Government Health Institutions in East Gojjam Zone, Northwest Ethiopia. *BMC Medical Informatics and Decision Making*, 17(116).
- [5].Sinaga, E. & Haryanto, 2016. Evaluasi Penerapan Sistem Informasi Puskesmas di Kabupaten Sleman. *Journal of Information Systems for Public Health*, 1(2), pp. 44-5
- [6]. Ahmadian, L., Salehi Nejad, S., Khajouei, R., 2015. Evaluation methods used on health information systems (HISs) in Iran and the effects of HISs on Iranian healthcare: A systematic review. *Int. J. Med. Inf.* 84, 444-453.
<https://doi.org/10.1016/j.ijmedinf.2015.02.002>
- [7]. Asemahagn, M.A., 2017. Determinants of routine health information utilization at primary healthcare facilities in Western Amhara, Ethiopia. *Cogent Med.* 4. <https://doi.org/10.1080/2331205X.2017.138797>
- [8]. Katurura, M.C., Cilliers, L., 2018. Electronic health record system in the public health care sector of South Africa: A systematic literature review. *Afr. J. Prim. Health Care Fam. Med.* 10. <https://doi.org/10.4102/phcfm.v10i1.1746>
- [9]. Patterson, B.W., Pulia, M.S., Ravi, S., Hoonakker, P.L.T., Schoofs Hundt, A., Wiegmann, D., Wirkus, E.J., Johnson, S., Carayon, P., 2019. Scope and Influence of Electronic Health Record-Integrated Clinical Decision Support in the Emergency Department: A Systematic Review. *Ann. Emerg. Med.* <https://doi.org/10.1016/j.annemergmed.2018.10.03>

Improving Healthcare Workers' Compliance On Informed Consent: A Literature Review

Roshynta Linggar Andatu
Master of Hospital Management
Universitas Muhammadiyah Yogyakarta
roshyntalinggar@gmail.com

Arlina Dewi
Master of Hospital Management Universitas
Muhammadiyah Yogyakarta
dewi_koen@yahoo.co.id

Abstract

Background: *Informed consent is an ethic and legal obligation, given before invasive procedure by the healthcare worker to the patient or family, part of patient safety implementation. Objective: To identify and describe qualitatively on how to increase healthcare worker's compliance on informed consent. Methods: Systematic searches of the literature were conducted using the major database, PubMed, by typing keywords (example compliance, healthcare worker, doctors, informed consent, agreement) which published from 2015 to January 2019. We summarized and analyzed the factors, intervention, and approach that can be used to increase healthcare worker's compliance on informed consent. Results: We identified 10 systematic review journals from 2015 to 2019. Most of the studies were in hospitals and the population consisted of doctors, dentists, nurses, and pharmacists. Factors that influence the compliance of healthcare worker in implementing informed consent include self-confidence, habits, knowledge, ability, gender, age, empathy, workload, socio-cultural, and health system. The interventions that can improve the compliance of healthcare worker in implementing of informed consent, in terms of education combined with audits and feedback, remind each other between healthcare worker, psychological interventions, attitudes and behavior, compare pre and post, and monitoring. Conclusions: Healthcare worker's compliance on informed consent influenced by socio-culture, workload, gender, knowledge, and ability. To improve compliance, it is necessary to conduct audits, feedback and improve cognitive behavior.*

Keywords: *Compliance, healthcare workers', informed consent*

I. INTRODUCTION

Medical practice is a service that provides help or assistance on the basis of the patient's trust in healthcare workers' especially to the doctors and not merely profit-oriented business relationships. In medical practice, doctors often do not provide standard information when going to take medical action. This is very important as a guarantee of legal protection for healthcare workers', hospitals and patients if medical or legal problems arise later.

Things that are not expected in a therapeutic transaction are required for informed consent. Informed consent is the doctor's obligation to explain everything about the patient's illness and to obtain approval for medical action. Approval is given by the patient after getting information from the doctor.

Informed consent are ethic and also legal obligation performing the invasive procedures. Consent is a conversation between the patient and the doctor. Consent requires good communication and interpersonal skills to build the trust, explore patients understanding and concerns, and delivers accurate information based on the procedure which has been planned before. Patients who will probably get the certain harm or develop complication following the surgery may feel that this possible outcome was not explained explicitly as a recognized risk of the procedure. This type of patient may choose to report their complaints and find legal advice to ask the compensation.

Informed consent is a complex process and at first the doctor have to define the indication of the procedure which lead to an informed decision or refusal to the procedure. Informed consent also understands as a formal activity which will be explained after the intervention has been made if the case is emergency.

In a study conducted on patients regarding informed consent obtained 77.3% of respondents did not understand medical terms and an explanation of informed consent was given, 27.4% were dissatisfied with the explanation delivered before surgery, 5% did not fully know the diagnosis before surgery, and 38.2% did not know their right to get informed consent before action.

II. RESEARCH METHOD

This research is a literature review on studies of healthcare workers' compliance on informed consent in many countries from 2015 to January 2019. Systematic searches of the literature were conducted using the major database, PubMed, by typing keywords "compliance", "obedience", "healthcare workers", "medical staff", "physician", "doctors", "informed consent", "agreement". We used two different strategies using the advance search function to find relevant studies in the PubMed database. We used "OR" and "AND" to combine each keyword. Sorting articles through abstracts and free full text articles. We summarized and analyzed the factors, intervention, and approach that can be used to increase healthcare worker's

compliance on informed consent. The inclusion criteria were applied that the study should be published as a full text original article, the participant were healthcare workers' consist of doctors, nurses, dentists, and pharmacists, working in hospital, and explained about how to improve the compliance of informed consent.

III. RESULTS

A total of 324 articles were taken from PubMed database. After removing, irrelevant studies from abstract and free full text, there were 10 studies included in inclusion criteria. Healthcare workers' compliance influenced by sociodemographic factors such as high burnout, age, work experience, income, and marital status.

Burnout itself associated with the decreasing of efficiency and productivity in workplace, practice income, and bigger probability to order non-essential tests or procedures for patient by the doctor. The most effective way to reduce burnout while improving compliance of healthcare workers' on informed consent is multi-pronged strategy.

IV. DISCUSSION

Some studies found that doctors with burnout are usually relevant in patient safety incidents, lack in some aspects like professionalism which show the quality of patient care (eg, compliance to treatment standard, communication skill, and also empathy), and get lower patient satisfaction ratings.

Some studies of the doctors' burnout were actually limited in Asian compared to the West. In Yemen, 63.2% of respondent physicians showed high emotional exhaustion, 19.4% showed high depersonalization, and 33.0% showed low personal accomplishment. The reported burnout rate among physicians in Asia, specifically in Malaysia represented a rate of 36.6% and 31.4% in Hong Kong.

Based on sociodemographic factor, younger age doctors have higher burnout than the old one. The prevalence usually under the age of 35. Doctors with less work experience under 10 years also have higher number in burnout. Another factors related to burnout are less family income and also among unmarried doctors compared with married doctors.

There are some individual elements, such as truancy, job turnover, and early secession affect the burnout. All of them relate in greater unnecessary medical fees (indirect and direct) and patient load. There is a way to reduce and erase the burnout with some intervention that we can do by changing organizational policies and regulation, such as reducing working time, caseloads, and on call periods. So, the intervention can be mixed and likely to be the result of individual and organizational level.

An effective strategy to increase healthcare workers compliance is a multi strategy. The combination of

management support, ease the access for supply, education, observation, training, reminders from the workplace also people surround it, surveillance, and feedback of the performance could raise the compliance about 30% (from 51.5% to 80.1%).

Studies on healthcare discuss the improvement which are the leaders' idea, educational gathering, printed educational stuff, educational outreach visits, audit, and feedback tell positive result in repairing professional practice, even the effects are small and do not always happen. Identify barriers and facilitators are generally recommended to tailor strategies to select or develop the implementation strategies for increasing healthcare consignment and optimising chance of effectiveness.

A multipronged oncoming may be required to improve the consent process. The researchs suggests that additional practice and examination for obtaining consent should be integrated into medical and surgical curricula. Both generic communication as non-technical, as practice, as well as consent as specific modules based on standardized patient simulation and assessment should be considered. Patient education can be given by written, web, or video-based information packages. It may be use to help patients better understand the implications of consenting to medical procedures and surgery.

To initiate behaviour change, patient feedback is more likely to be chosen if the participants consider about the process, instrument and also provider to be credible. It measures the specific behavioural change through reflective discussion. They will discuss the feedback, guided by a skilled facilitator who use open ended questions and will receive narrative comment.

Informed Consent process have to be seen as a two-way process with active participation from both sides to reduce conflict and increase satisfaction. Implementation of simple measures, such as use of information instruments (brochures, web pages, smartphone applications), explain time for parental interests/ questions, and optimizing the setting in which informed consent is gain, may increase overall satisfaction in informed consent process.

V. CONCLUSION

Awareness and intention from healthcare workers' to change a better habit is important. One of the responsibility that must be taken to the patient is giving informed consent before doing the medical procedure. Based on some studies, they found a big problem in healthcare system especially in the compliance of healthcare workers' particularly the doctors to explain clearly about informed consent. The factors which influenced it compliance can be solved by giving an effective intervention.

REFERENCES

1. Alshehri, A.A., Park, S., Rashid, H., 2018. Strategies to improve hand hygiene compliance among healthcare workers in adult intensive care units: a mini systematic review. *J. Hosp. Infect.* 100, 152–158. <https://doi.org/10.1016/j.jhin.2018.03.013>
2. Bagnall, N.M., Pucher, P.H., Johnston, M.J., Arora, S., Athanasiou, T., Faiz, O., Darzi, L.A., 2017. Informing the process of consent for surgery : identification of key constructs and quality factors. *J. Surg. Res.* 209, 86–92. <https://doi.org/10.1016/j.jss.2016.09.051>
3. Baines, R., Regan de Bere, S., Stevens, S., Read, J., Marshall, M., Lalani, M., Bryce, M., Archer, J., 2018. The impact of patient feedback on the medical performance of qualified doctors: a systematic review. *BMC Med. Educ.* 18, 173. <https://doi.org/10.1186/s12909-018-1277-0>
4. Chotai, P.N., Nollan, R., Huang, E.Y., Gosain, A., 2017. Surgical informed consent in children: a systematic review. *J. Surg. Res.* 213, 191–198. <https://doi.org/10.1016/j.jss.2017.02.047>
5. Clough, B.A., March, S., Chan, R.J., Casey, L.M., Phillips, R., Ireland, M.J., 2017. Psychosocial interventions for managing occupational stress and burnout among medical doctors: a systematic review. *Syst. Rev.* 6. <https://doi.org/10.1186/s13643-017-0526-3>
6. Ebben, R.H.A., Siqeca, F., Madsen, U.R., Vloet, L.C.M., van Achterberg, T., 2018. Effectiveness of implementation strategies for the improvement of guideline and protocol adherence in emergency care: a systematic review. *BMJ Open* 8, e017572. <https://doi.org/10.1136/bmjopen-2017-017572>
7. Erkan, I., Mayadagli, Y., Akbaba, M., 2017. Assessment of patients' knowledge level regarding the informed consent from the ethical aspect. *Romanian J. Leg. Med.* 25, 120–124. <https://doi.org/10.4323/rjlm.2017.120>
8. Lo, D., Wu, F., Chan, M., Chu, R., Li, D., 2018. A systematic review of burnout among doctors in China: a cultural perspective. *Asia Pac. Fam. Med.* 17. <https://doi.org/10.1186/s12930-018-0040-3>
9. Lühnen, J., Mühlhauser, I., Steckelberg, A., 2018. The quality of informed consent forms. *Dtsch. Aertzblatt Online.* <https://doi.org/10.3238/arztebl.2018.0377>
10. Mayasari, D.E., 2017. Tinjauan Yuridis Tentang Informed Consent Sebagai Hak Pasien Dan Kewajiban Dokter 13, 10.
11. Panagioti, M., Geraghty, K., Johnson, J., Zhou, A., Panagopoulou, E., Chew-Graham, C., Peters, D., Hodgkinson, A., Riley, R., Esmail, A., 2018. Association Between Physician Burnout and Patient Safety, Professionalism, and Patient Satisfaction: A Systematic Review and Meta-analysis. *JAMA Intern. Med.* 178, 1317. <https://doi.org/10.1001/jamainternmed.2018.3713>
12. Rusad, I., 2007. (Studi Pada Rumah Sakit Umum Puri Husada Tembilahan) 120.

Use of Failure Mode Effect Analysis Method to Reduce Medication Error in Hospitalized Patients: Literature Review

Nur Laela

Master of Hospital Management
Universitas Muhammadiyah Yogyakarta
nurlaela139@yahoo.com

Arlina Dewi

Master of Hospital Management
Universitas Muhammadiyah Yogyakarta
dewi_koen@yahoo.co.id

Abstract

Background: medication error is a preventable event can cause inaccurate use of the drug so that it endangers patient when the drug is in the control of health personnel and patients. Failure Mode and Effect Analysis (FMEA) is a prospective analysis method to identify potential risks and can be implemented to improve patient safety. **Objective:** to identify potential and risk of failure in medication error by using Failure Mode and Effect Analysis as a method of preventing and evaluating medication errors in hospitalization. **Methods:** literature review regarding the journal about Failure Mode and Effect Analysis Method and medication error. Journal searches are accessed from Pubmed database. All journals are from abroad and in English. The results of literature review from 2009-2018 found 15 journals related to FMEA method with medication errors. From literature review on medication errors in 2006-2018, 17 journals were found. **Result:** this review shows that medication errors that often occur are medication administration, dispensing, prescribing, preparation, transcription, reconciliation errors. Failure Mode Effect and Anlysis Method used to identify a potential risks and can be implemented to improve patient safety. The FMEA method is based on teamwork to identify, evaluate, prevent, control the effects on risks before they have an effect on patients. From 15 journals the FMEA method can improve patient safety in terms of intravenous nutrition administration, treatment processes, laboratory results, blood transfusions and transplants. **Conclusion:** This review explains that the FMEA method can be useful in reducing the number of risks and improving the quality of health services in hospitals.

Keyword : Failure Mode and Effect Anlysis, medication error, hospitalized patient, potential risk, patient safety

I. INTRODUCTION

Medication errors are one of the biggest problems in the health care system. Medication error is a preventable event can cause inaccurate use of the drug so that it endangers patient when the drug is in the control of health personnel and patients. The best way to prevent medical errors is to identify errors that can occur and identify systemic causes, then learn the problem, and finally warn the system to prevent it from happening again. In this regard, the prospective risk analysis technique is one of the famous risk management and analytical tool using a prospective approach based on group risk analysis and efforts to prevent potential errors[1].

Failure Mode and Effects Analysis (FMEA) technique is a prospective risk analysis method. Root cause analysis is the example that most often uses this approach.

One of the most used Porspective Hazard Analysis (PHA) analysis techniques is Failure Mode and Effect Analysis (FMEA) or Health Failure Mode and Effect Analysis (HFMEA) or Failure Modes, Effects, and Criticality Analysis (FMECA)). FMEA may be the first method that appears when many health risk managers consider PHA, which is far from the only method available[2].

The prospective risk analysis tool most commonly applied in healthcare is FMEA. It has been defined as a proactive tool that can be used to identify potential vulnerabilities to occur in complex and high-risk processes and to produce corrective and preventive actions to prevent adverse events from occurring [3].

FMEA is the first step for system reliability. FMEA also involves several components of the subsystem review that serve to identify the mode of failure that occurred, as well as the potential damage (cause and effect) that occurred. in each component, the failure mode and its effect on the entire system will be recorded on a particular FMEA worksheet. The approach using FMEA allows each element or component that consists of the process to be investigated in relation to the cumulative numerical value, risk priority number (RPN)[4], which can be used to prioritize actions to be taken based on the severity, probability and detection ability of each failure mode [3].

the stages and structural model of FMEA is to form a team of experts to determine the process and identify conditions, failure modes and effects that occur, besides also determining the probability of failure, the severity of the effect, and the probability of failure and effects before the patient or staff is harmed due to the failure mode not identified. Repetition, severity and probability of identification receive a score between 1 and 10, and ultimately, the Risk Priority Number (RPN) which is the same as the multiplication is determined and finally this number will be recalculated after applying corrective strategies to determine the effectiveness of the model [5]. The present study attempted to review unveiled risks by the FMEA technique in various hospital wards. It also tried to identify main aspects of the FMEA model in the hospital wards which include target equipment or process, steps of implementing the FMEA model, the cooperating team, the riskiest and safest activities, and the final impact of model implementation. The implementation included these stages: 1) the process identification, 2) the analysis of risks and determining RPN, 3) planning and forming an S, O, D (severity, occurrence, detectability) matrix and dividing it

into 4 areas (high-risk or urgent, force majeure, programming and control), 4) the interventions and 5) implementing the model again[3].

Risk management is the ability to identify risk factors that are on the one hand, and risk analysis and selection of appropriate strategies to prevent, control and eliminate them on the other. Clinical service quality is always viewed from various perspectives such as safety, acceptance, and reliability. Admission refers to the level of acceptance of the risk of health services by patients, doctors, or other health related staff who are exposed to these risks[3]. Reliability of a system refers to the possibility of satisfactory system performance in certain working conditions for a certain period of time [6].

II. RESEARCH METHOD

Literature review regarding the journal about *Failure Mode and Effect Analysis Method* and medication error. Journal searches are accessed from Pubmed database. All journals are from abroad and in English. The results of literature review from 2009-2018 found 15 journals related to FMEA method with medication errors. From literature review on medication errors in 2006-2018, 17 journals were found. Systematic searches of the literature were conducted using the major database, PubMed, by typing keywords “Failure Mode and Effects Analysis”, “healthcare failure mode and effect analysis”, “prospective risk analysis”, “proactive risk analysis”, “systemic risk analysis”, “prospective risk assessment”, “proactive risk assessment”, “dispensing”, “dispensing error”, “pharmacists”, “pharmacy”, “probabilistic risk assessment”, “socio-technical probabilistic risk assessment”. We used two different strategies using the advance search function to find relevant studies in the PubMed database. We used “OR” and “AND” to combine each keyword. Sorting articles through abstracts and free full text articles. We summarized and analyzed the factors, intervention, and approach that can be used to identify potential and risk of failure in medication error by using *Failure Mode Effect Analysis* as a method of preventing and evaluating medication errors in hospitalization. The inclusion criteria were applied that the study should be published as a full text original article, the participant were healthcare workers consist of doctors, nurses, dentists, and pharmacists, working in hospital, and explained about how *Failure Mode and Effect Analysis* as a method of preventing and evaluating medication errors in hospitalization[7].

III. RESULTS

A total of 218 articles were taken from PubMed database. After removing, irrelevant studies from abstract and free full text, there were 17 journals were found in inclusion criteria. The literature review shows that medication errors that often occur are medication administration, dispensing, prescribing, preparation, transcription, reconciliation errors. *Failure Mode and Effect Analysis Method* used to identify potential risks and can be implemented to improve patient safety. The FMEA method is based on teamwork to identify, evaluate, prevent, control the effects on risks before they have an effect on patients. From 15 journals the FMEA method can improve patient safety in terms of

intravenous nutrition administration, treatment processes, laboratory results, blood transfusions and transplants.

IV. DISCUSSION

Medication errors often occur in the hospital causing side effects to the drug and the length of stay of the patient in the hospital. Medication errors can occur in one of three steps in the treatment process, namely prescription, drug administration and administration[1,8].

The treatment process is vulnerable and prone to errors because it is a complex five-phase process, namely (a) prescribing, (b) verifying, (c) preparing / dispensing (d) administration, and (e) monitoring. Medication errors can come from all of these phases[9].

Medication safety is part of the quality of care, service and patient safety. Medicines are therapeutic interventions to reduce harm to patients, promote healing and improve health and quality of life, but all drugs have potential side effects. Medication errors and drug side effects can endanger the patient. Medication errors are errors that occur during the treatment phase, but most errors occur in the administration, expenditure, preparation, delivery and documentation of drugs prescribed, ordered and given [7, 10,11,12].

Medication errors and drug side effects can endanger the patient. Medication errors are errors that occur during the treatment phase, but most errors happen in the administration, dispensing, preparation, delivery and documentation of prescribed, ordered and given medication [10].

Failure Mode and Effect Analysis (FMEA) is a method that can be used to analyze failure modes systematically in order to improve security. FMEA is commonly used in military systems, such as aerospace, automotive, and health care systems. The FMEA process is a method for identifying potential failures as well as the impact caused. While using a new retrospective analytical technique the Root Cause Analysis (RCA) method can be used if the results occur with a drug labeling system [13].

Using the FMEA methodology allows in-depth understanding to uncover the roots of danger and take steps to reach acceptable strategies for patient safety, effective pharmaceutical activities, and economic management. This is a proactive and effective risk assessment tool to help make possible mistakes and reduce potential risks. Conducting the FMEA: [4]

- Step 1: selecting the process
- Step 2: establishing a multidisciplinary action team
- Step 3: mapping the process
- Step 4: targeting and listing the possible failure modes
- Step 5: prioritization of the failure modes.
- Step 6: development of action plans

In step 5, each team provides a hazard analysis estimate by prioritizing the failure mode. We have identified failure modes identified using the FSP rating scale [4]:

1. Frequency of occurrence (F)
2. Effect of severity (S)
3. Probability of detection (P).

Products from RPN, which is an index for identifying hazards for modes that have the greatest potential risk (higher values represent a greater risk) [4].

From some of the literature reviewed by Setiasih's narrative, Zhila Najafpour, et al in Tehran, 2017, explained that FMEA can help them reduce the potential risk of blood transfusion. The structured FMEA in this study was conducted in 2014, and corrective action was implemented and evaluated after 6 months. During the analysis, all steps of blood transfusion were detected based on direct analysis and opinions of related experts. In this study, the score of the FMEA score decreased from before and after further intervention. However, according to the researchers, the application of FMEA requires experts to [13]

Research by Giovanna Bonfant, 2010, in Italy, stated that all FMEA processes were carried out by researchers, increasing the total RPN resulted in a substantial increase in the process of hemodialysis services in patients. There is a decrease in RPN scores before and after FMEA implementation. In this study there were suggestions from FMEA researchers to contribute to medical reporting and auditing at the Aosta Valley Health Care Organization, to verify the control and utilization measures [13].

By preventing failures identified by the FMEA process, that the results of medical errors can be prevented by applying FMEA in the service and maintenance process, and assessments to determine the impact of the greatest failure, making policies can determine the priority of potential failures found. Of course, every policy maker has a variety of views and reasons that are tailored to the current conditions of the hospital [13].

Although the use of FMEA is exhausting and requires a lot of time in its use, but this technique is useful in improving the health care process and improving patient safety, thereby increasing the alertness of hospital leaders and owners. Can be developed [13,14].

The conclusion of Setiasih's literature review literature is that FMEA is proven to reduce the number of potential failures before being repaired, so that medical errors can be prevented. In implementing FMEA, any errors can occur during the determination of potential failures and the determination of scores on the RPN, therefore, it is expected that the team involved in making FMEA experts in the service process is designed. Some studies also suggest that to verify the effectiveness of FMEA use, it is important to compare the potential failure of FMEA with other risk management tools to identify failure modes, such as incident reporting reports and medical audits [13].

Articles from Rodriguez-Gonzales, et al in Spain, 2015, explain that the systematic implementation of failure modes, effects and critical analysis of FMECA by multidisciplinary teams is a method that is useful in supporting and detecting failure modes, then identifying safety strategies and proactively evaluating an increase in administrative security, especially when it is difficult to directly measure results because of a very low incidence [15,16].

An article from Lee in Seoul, 2017, explains that FMEA is a powerful tool for improving clinical and

comprehensive quality that enhances the quality of potential risks [17].

The systematic review of Dastjerdi in Iran, 2017, describes the results of a study that shows a model of Failure Mode and Effects of Analysis that has been mostly applied in Pediatric and Oncology wards and most have studios about the process. Most papers have been called model steps, and they have recalculated the RPN to determine the application model. However, they only consider a few issues. In general, the most recommended and considered models have become useful instruments to reduce the number of elements that improve and improve service quality[1,18,19,20].

V. CONCLUSION

Failure Mode and Effect Analysis Methods are useful and efficient for reducing the number of risks and improving the quality of services in hospitals. FMEA can be utilized in identifying potential risks and then practiced and implemented to improve patient safety[2]. This systematic method is based on team work to identify, evaluate, prevent, control or eliminate potential risk causes and causes in a system before the final product is sent to the end user[1].

REFERENCES

1. Dastjerdi, H. A. (2017). Evaluating the application of failure mode and effects analysis technique in hospital wards: a systematic review. *J Inj Violence Res*, 9 (51-60).
2. Alsaidan, J. (2018). Systematic review of the safety of medication use in inpatient, outpatient and primary care settings in the Gulf Cooperation Council countries. *Saudi Pharmaceutical Journal*.
3. Setiasih, P. I., & Junadi, P. (2017). Effectiveness of Failure Modes Effect Analysis (FMEA) to Reduce Medical Error. *Vol. 02, No. 2, hal 25 - 29*.
4. Card, A. J. (2012). Beyond FMEA: The structured what-if technique (SWIFT). *American Society for Healthcare Risk Management of the American Hospital Association*.
5. Ofek, F. (2016). Introducing a change in hospital policy using FMEA methodology as a tool to reduce patient hazards. *Israel Journal of Health Policy Research*, 5:30.
6. Walsh, E. K. (2017). Economic impact of medication error: a systematic review. *pharmacoepidemiology and drug safety*.
7. Stojkovic, T. (2017). Using Prospective Risk Analysis Tools to Improve Safety in Pharmacy Settings: A Systematic Review and Critical Appraisal. *Journal Patient Safety*.
8. Saedder, E. A. (2014). Identifying high-risk medication: a systematic literature review. *Eur J Clin Pharmacol*, 70:637–645
9. McDonald, K. M. (2013). Patient Safety Strategies

- Targeted at Diagnostic Errors . *Annals of Internal Medicine*, 158:381-389.
10. Whittaker, M. H. (2015). Risk Assessment and Alternatives Assessment: Comparing Two Methodologies. *Society for Risk Analysis*, Vol. 35, No. 12.
 11. Smeulders, M. (2015). Quality Indicators for Safe Medication Preparation and Administration: A Systematic Review. *PLoS ONE*, Vol 10, Pages 4.
 12. Metsala, E., & Vaherkoski, U. (2014). Medication errors in elderly acute care – a systematic review. *Scand J Caring Sci*, 28; 12–28
 13. Anthony, L. (2008). What’s Wrong with Risk Matrices? *Society for Risk Analysis*, Vol. 28, No. 2.
 14. Sarfati, L. (2018). Human-simulation-based learning to prevent medication error: A systematic review. *J Eval Clin Pract*, 1–10.
 15. Salmasi, S. (2018). Medication Errors in the Southeast Asian Countries: A Systematic Review. *PLOS ONE*.
 16. Rodriguez-Gonzalez, C. G., Martin-Barbero, M. L., Herranz-Alonso, A., Durango-Limarquez, M. I., Hernandez-Sampelayo, P., & Sanjurjo-Saez, M. (2015). Use of failure mode, effect and criticality analysis to improve safety in the medication administration process. 21 (549–559).
 17. Lee, H., Lee, H., Baik, J., Kim, H., & Kim, R. (2017). Failure mode and effects analysis drastically reduced potential risks in clinical trial conduct.
 18. Reader, T. W., & Gillespie, A. (2013). Patient neglect in healthcare institutions: a systematic review and conceptual model. *Bio Med Central*, 13:156.
 19. Walsh, E. K. (2017). Economic impact of medication error: a systematic review. *pharmacoepidemiology and drug safety*
 20. Berdot, S., Roudot, M., Schramm, C., Katsahian, S., Durieux, P., & Sabatier, B. (2015). Interventions to reduce nurses’ medication administration errors in inpatient settings: A systematic review and meta-analysis. *International Journal of Nursing Studies*.

The Analysis of Determinan Factors Affecting Patient Safety Culture in Hospital

Yusuf Susanto, Nur Hidayah
 Master of Hospital Management
 Muhammadiyah University of Yogyakarta
 Yogyakarta
 mmr_ummy@yahoo.co.id

Abstract:

Patient safety is important and fundamental thing in the daily activities of the hospital. This is one measure of the success of a hospital in carrying out its policies so that patients feel safe, comfortable and satisfied. This paper aims to identify determinant factors that influence the patient safety culture at the hospital.

The literature search procedure to answer the problem is by searching the library online using the Pubmed search instrument, Cochrane Library, Google Scholar, Google and the relevant text book. The keywords used are "patient safety", "patient safety culture", "hospital", "determinant factors in patient safety culture", and "patient safety dimensions" using limits, studies conducted at the hospital to hospital employees, publications English and Indonesian, the last 10 years publication. With the search method, initially there were 30 articles, 22 of which met the criteria, published until 2018.

The results of the analysis from the literature review show that the patient safety culture is influenced by various determinant factors, including perceptions of management, work team support, work stress, job satisfaction towards the patient safety culture in the hospital. These factors were assessed by using some international standardized questionnaires such as the Safety Attitudes Questionnaire (SAQ) and questionnaire from the Agency for Healthcare Research and Quality (AHRQ). Leader factors in hospitals play an important role in the realization of a patient safety culture.

Keywords: Patient safety, determinant factors, hospital, patient safety culture

INTRODUCTION

Patient safety is an important and global issue in health services. The issue has been a concern since the 1990s and has increasingly become a concern since the 1999 report from the Institute of Medicine (IOM), states that in the United States it is projected to have 44,000 to 98,000 deaths each year due to medical errors which can actually be prevented. In Indonesia the Safety Incident Report found that there were reports of cases of Unexpected Events (14.41%) and Nearly Injured Event (18.53%) caused by clinical processes or procedures (9.26%), medication (9.26%), and patients falling (5.15%) (in James, 2013).

Patient safety is a hospital system that makes patient care safer, prevents injuries that are caused by misconduct or does not take the necessary actions. According to The Health Foundation, 2011, safety culture is concerned with the extent to which organizations prioritize and support safety enhancement.

The effort to create or build a safety culture is the first step in achieving patient safety, as stated in "Seven Steps Towards

Hospital Patient Safety" in Indonesia, namely building a patient safety culture, leading and supporting staff, integrating risk management activities, improving reporting activities, involving and communicating with patients, learning and sharing experiences about patient safety and implementing

solutions to prevent injury. Safety culture is built by various factors (dimensions), dimensions of safety culture are leadership, teamwork, communication, workload and security systems (Indonesian Ministry of Health, 2008).

Based on the above, the writer wants to compile articles related to issues in the patient safety culture at the Hospital. This article aims to analyze the factors that influence the culture of patient safety based on literature review

LITERATURE REVIEW

Patient Safety Culture

According to WHO, patient safety is no preventable danger to patients during the health care process. The discipline of patient safety is a coordinated effort to prevent damage that occurs to patients, which is caused by the health care process itself (WHO, 2009). While the definition of patient safety according to the Hospital Patient Safety Committee is the freedom of patients from harm / injury that should not occur or free from harm that will potentially occur (such as illness, physical / social / psychological injury, disability, death, etc.), related to health services (Guidelines for Reporting Patient Safety Incidence).

The patient safety culture is an important factor in efforts to reduce adverse risks in hospitals and improve patient safety. This study by Wang et al. (2014) aims to describe nurses' perceptions of the culture of patient safety and the frequency of adverse risks, and examine the relationship between the two.

Assessment of Hospital Safety Culture

Patient safety is the most important component in the quality of health services. Hospitals as health care organizations must be able to improve patient safety by seeking the realization of a safety culture. In building a safety culture, it is very important for hospitals to measure cultural development by taking cultural measurements regularly. The first measurement is very important as the basic data that will be used as a reference for the preparation of the program. The Hospital Survey on Patient Safety Culture, issued by the AHRQ (American Hospital Research and Quality) in November, 2004, is designed to measure opinion hospital staff regarding patient safety issues, medical errors, and incident reporting. This survey consisted of 42 items that measured 12 dimensions of patient safety.

The survey also contains two questions to respondents regarding the level of safety culture in their respective work units and the large number of incidents they have reported in the past year.

There are 3 stages to building a safety culture:

1. Stage 1: Initial assessment with assessment of facilities, resources, and hospital patient safety environment, as well as cultural survey of safety and measurement of data. Based on measurements, is the hospital ready? If not, go to the development of a safety climate and return to the initial cultural survey. If the initial assessment has been carried out, go directly to stage 2.
2. Stage 2: planning, training, and implementation. Training is held to support the implementation of interventions. Interventions include trials and then proceed to stage 3
3. Stage 3: Maintain / maintain. This stage includes integrating, planning monitoring (with re-survey), and sustainable development. Sustainability development includes retraining to bring about change towards a better safety culture.

RESEARCH METHODS

The procedure for searching literature to answer these clinical problems is by searching the library online using the Pubmed search instrument, Cochrane Library, Google Scholar, Google and the relevant text book. The keywords used are "patient safety", "patient safety culture", "hospital", "patient safety culture determinant factors", and "patient safety dimensions" using limits, studies conducted at the hospital to hospital employees, publications English and Indonesian, the last 15 years publication. With the search method, initially there were 30 articles, of which 22 articles met the criteria published until 2018. Further searches manually in the relevant bibliography produced several articles outside of that time period. After searching the title and abstract of the articles, 22 articles were relevant to the problem.

RESULTS AND DISCUSSION

This paper describes the factors that influence the patient safety culture at the hospital. Based on and sourced from the literature search that is relevant to the issue, the author will explain various dimensions related to patient safety.

Safety has become a global issue including hospitals. Therefore, patient safety is a top priority to be implemented and this is related to the occurrence of Patient Safety Incidents in hospitals. According to the Indonesian Ministry of Health (2008) in the National Hospital Patient Safety Guide, the first step in the patient safety program at the hospital is to build a patient safety culture or raise awareness of all employees on the importance of the value of hospital safety. So, to improve the quality of patient safety services at the unit level, efforts must be made to change the patient safety culture in all hospital units.

The Brown & Wolosin study (2013) tried to explore the relationship between staff perceptions of safety culture and ongoing steps in the hospital based on the structure of the nursing unit, the treatment process, and the risks that harm patients. The relationship between nursing measures, hospital performance and safety culture was explored in 9 California hospitals and 37 nursing units. Significant relationships found are process steps for prevention of falls. Several associations were identified from safety culture and the structure of care delivery, such as a mix of skills, staff turnover, and workload intensity that showed a significant relationship with safety culture.

To improve the patient safety culture, nurses' awareness also needs to be improved. Research conducted by Kim et al. (2013) aimed to identify factors that influence perceptions of the importance and practice of patient safety management among hospital employees in Korea. These results indicate the need to develop strategies to improve the perception of the importance of building and implementing a patient safety culture among all hospital employees (Kim et al, 2013).

Refers to four patient safety goals, namely the exact location accuracy, the right procedure and the right patient operation. One of the targets is the use of a surgical checklist. Research conducted by Urbach, et al. (2014) in hospitals in Ontario, Canada, conducted a natural experiment to assess the effectiveness of a surgical safety checklist in hospital practice regulations. The results showed that during the 3 months before and after the application of the surgical safety checklist, from a total of 101 hospitals with 109,341 and 106,370 procedures performed by each hospital: From these results it can be concluded that the implementation of the surgical safety checklist in Ontario, Canada, was not associated with a significant reduction in operative mortality or complications (Urbach *et al*, 2014).

The patient safety culture is an important factor in efforts to reduce adverse risks in hospitals and improve patient safety. One study by Wang et al. (2014) was aimed at describing nurses' perceptions of the culture of patient safety and the frequency of adverse risks, and testing the relationship

between the two. The results of the Patient Safety Culture response varied from 23.6% to 89.7%. There were 47.8-75.6% nurses who estimated that adverse events had occurred in the past year. After controlling for all factors, there was a significant decrease in the incidence of pressure ulcers (OR = 0.249), prolonged physical restraint (OR = 0.406), and complaints (OR = 0.369). These results confirm that improving the patient safety culture is associated with a reduction in the occurrence of adverse risks (Wang, et al., 2014).

The culture of patient safety is an important quality indicator in health services and has been associated with patient outcomes obtained by patients in the hospital. Research conducted by Hawkins & Flynn (2015) aimed to examine the relationship between patient safety culture and adverse events reported by nurses in hemodialysis outpatient facilities. The method of this research is correlational, using a cross-sectional survey design. The analytic sample consisted of 422 nurses working in outpatient dialysis facilities in the United States. The results of the study show all the relationships between items of patient safety culture and events that harm patients are in the expected direction. The findings of this analysis show that a positive patient safety culture is an important variable for optimal patient outcomes in outpatient settings (Hawkins & Flynn, 2015)

Research from Mulyati et al, 2016 regarding the safety culture of patients in Kuningan District Hospital with the results that most 51.1% of respondents stated that the work team supported the culture of patient safety, while 58% had a good perception of RS and 61 management, 4% stated stress, 67% of respondents stated that their working conditions were not good, but most 84.1% of respondents said they were satisfied with the work they are currently doing. The data shows that the possibility of an error or unexpected event in patients treated at the Kuningan Government Hospital is still high.

Unexpected events or near-injury events are not only errors of human factors / negligence of service providers but there are other factors that contribute to the occurrence of adverse events for patients. There are four layers that comprise the occurrence of an accident, namely: organizational management policy in the occurrence of accidents, unsafe supervision (precautionary supervision), precondition for unsafe acts (conditions that support the emergence of unsafe activities) (Reason et al., 2008).

The democratic leadership style is the leadership style used by the leadership of the Kuningan District government hospital and has an organizational structure with clear lines of communication, so there is no difficulty in communicating issues especially issues regarding patient safety, but there is still a culture of shaming and blaming. so that there are concerns in reporting unexpected events and near-injury events, so that if this happens to be only a conversation or addressed at the managerial level where the incident occurred, only certain events were reported but no feedback. Hospital management has a commitment to improve the patient safety culture but has not been thoroughly socialized to every employee.

Based on the results of this study found the fact that the work team that supports most (57.8%) has a good patient safety culture while respondents who feel the work team is less supportive (90.7%) have a poor patient safety culture. Based on the results of the bivariate analysis, the work team has a significant relationship with the patient safety culture (p-value 0.0005) and the odds ratio 13.34 means that the support team has a 13 times greater chance of creating a patient safety culture (Mulyati, et al, 2013).

The work team is fundamental in improving the quality of care and the culture of patient safety because the work team will provide color to the work atmosphere, therefore the leadership or management of the hospital needs to ensure the effectiveness and conduciveness of the work team. In addition to creating a work safety culture, there must be a synergy between the leadership, the team leader and team members who interact directly with the patient. .

Kanz-Navon et al., (2005), found the fact that when safety culture is a top level manager's priority, hospital service units experience fewer errors in the implementation of care. Shipton et al., (2008) in their study showed that there was relevance between staff perceptions of managerial leadership effectiveness which was associated with a lower number of patient complaints and a better level of clinical mastery.

The process of building good perceptions of leaders / managers must show their commitment to patient safety, in other words the leaders must be role models, each behavior must show patient safety efforts. In addition, one of the factors in creating a patient safety culture is reporting incident / unexpected conditions and the existence of a feedback system, this condition has not been entrenched in health care agencies because there are factors of fear or concern or even consider the incident a disgrace to health workers must be covered. The culture of learning from mistakes and not blaming the officers who make mistakes must be shown by the leadership (Ricci et al, 2017).

The application of the transformational leadership model has an impact at both the organizational and individual levels. According to Indonesian Ministry of Health (2008), transformational leadership has 4 dimensions namely; 1) idealized influence, 2) inspirational motivation, 3) intellectual stimulation (intellectual stimulation). 4) individualized considerations, in other words transformational leaders must be able to be role models (admired, respected and trusted), able to inspire team spirit in the organization, able to grow new ideas, provide creative solutions to the problems faced subordinates, and provide motivation to subordinates to look for new approaches in carrying out organizational tasks, and want to listen attentively to subordinates 'input and pay attention to the subordinates' needs for career development.

CONCLUSION

The work team, perceptions of leadership, stress and job satisfaction have a meaningful relationship to the patient safety culture. Perception of leadership is a determinant factor for the creation of a patient safety culture, therefore leadership style,

communication techniques and leadership managerial abilities are things that really need to be considered in creating a conducive working atmosphere in an effort to create a patient safety culture.

RECOMMENDATION

This paper presents a culture of patient safety in several health care facilities taken from relevant sources. It is hoped that the results of discussing the patient safety culture at the hospital can help to get an idea of things related to the patient safety culture. This paper is expected to help readers to broaden their knowledge related to the factors that influence the culture of safety at the hospital. A better and more complete paper presentation in the future is expected to increase knowledge.

BIBLIOGRAPHY

- Achakzai, Haroon. 2014. "Research proposal for Assessing Patient Safety Culture in Public Hospitals under the Essential Package of Hospital Services (EPHS) in Afghanistan." Thesis, Georgia State University, 2014. https://scholarworks.gsu.edu/iph_theses/342
- Ascroft. 2005. What is Patient Safety Culture? A Review of the Literature: Patient Safety Culture. *J. Nurs. Scholarsh.* 42, 156–165. <https://doi.org/10.1111/j.1547-5069.2009.01330.x>
- Brown & Wolosin., 2013. The outcomes of recent patient safety education interventions for trainee physicians and medical students: a systematic review. *BMJ Open* 5, e007705–e007705. <https://doi.org/10.1136/bmjopen-2015-007705>
- Depkes RI. (2008). Panduan Nasional Keselamatan Pasien Rumah Sakit (Patient Safety): Utamakan Keselamatan Pasien. Jakarta: Depkes RI.
- Hawkins & Flynn. 2015. The patient safety culture: a systematic review by characteristics of Hospital Survey on Patient Safety Culture dimensions. *Int. J. Qual. Health Care* 30, 660–677. <https://doi.org/10.1093/intqhc/mzy080>
- James. 2013. Relationship between Patient Safety Culture and Safety Outcome Measures among Nurses 80.
- Katz-Navon, T., Naveh, E., & Stern, Z. (2005) Safety climate in healthcare organisations: A multidimensional approach. *Academy of Management Journal*, 48, 1075–1090.
- Kim et al, 2013. Identifying patient-centred recommendations for improving patient safety in General Practices in England: a qualitative content analysis of free-text responses using the Patient Reported Experiences and Outcomes of Safety in Primary Care (PREOS-PC) questi. *Health Expect.* 20, 961–972. <https://doi.org/10.1111/hex.12537>
- Kirkman MA, Sevdalis N, Arora S, et al. 2015. The outcomes of recent patient safety education interventions for trainee physicians and medical students: a systematic review. *BMJ Open* 2015;5:e007705. doi:10.1136/bmjopen-2015-007705
- Mulyati, L., Rachman, D., Herdiana, Y., 2016. Faktor Determinan yang Memengaruhi Budaya Keselamatan Pasien di RS Pemerintah Kabupaten Kuningan 4, 12.
- The Health Foundation 2011. A National Study of Patient Safety Culture in Hospitals in Sweden: *J. Patient Saf.* 1. <https://doi.org/10.1097/PTS.0000000000000369>
- Urbach, D. R., Govindarajan, A., Saskin, R., Wilton, A. S., & Baxter, N. N. (2014). Introduction of Surgical Safety Checklists in Ontario Canada. *The New England Journal of Medicine*, 1029- 1038.
- Patient Safety Project. 2012. Determinants of Hospital Efficiency and Patient Safety in the United States 158.
- Reason, J. (2008). *The human contribution: Unsafe acts, accidents and heroic recoveries.*
- Reiz et al. 2018. The patient safety culture: a systematic review by characteristics of Hospital Survey on Patient Safety Culture dimensions. *International Journal for Quality in Health Care*
- Rosyada, S.D., n.d. Gambaran Budaya Keselamatan Pasien Pada Perawat Unit Rawat Inap Kelas Iii Rumah Sakit Umum Daerah Pasar Rebo Bulan Juni Tahun 2014 174.
- Sammer et al. 2010. What is Patient Safety Culture? A Review of the Literature. *Journal of Nursing Scholarship.* 2010; 42:2, 156–165.
- Wang, X., Liu, K., You, L. M., Xiang, J. G., Hu, H. G., Zhang, L. F., et al. (2014). The relationship between patient safety culture and adverse events: a questionnaire survey. *International Journal of Nursing Study*, 1114-1122.
- Zhou, P., Bundorf, M.K., Gu, J., He, X., Xue, D., 2015. Survey on patient safety climate in public hospitals in China. *BMC Health Serv. Res.* 15. <https://doi.org/10.1186/s12913-015-0710-x>

The Cost Analysis and the Prediction of Complication Rate among People with Diabetes Mellitus Type 2

Firman Pribadi

Universitas Muhammadiyah Yogyakarta, Indonesia, firmanpribadi@umy.ac.id

Iman Permana

Universitas Muhammadiyah Yogyakarta, Indonesia, imanpermana@umy.ac.id

Abdul Ghofir

Universitas Muhammadiyah Yogyakarta, Indonesia, agifandi@gmail.com

Abstract-Background: *The implementation of package payment system for healthcare in Indonesia, or INA CBGs, as part of the National Health Security program, has been a focus of scrutinized studies. Indeed, for any private hospital, profit has been served as the main focus in supporting its operational. On the other hand, the prevalence of non-communicable diseases such as diabetes with the wide range of possible complications has proven to be costly. Therefore, to maintain the sustainability of its service, private hospitals have to put the more efficient and effective cost management system into place, especially in the existence of INA CBGs. Objectives:* The objectives of this study is to predict the development of complication and the rate of medication cost among the member of JKN in one diabetes outpatient department in a hospital in Yogyakarta. **Methods:** *The study using bivariate analysis to show the correlation between complications and medication cost and medication, and using Multiple Discriminant Analysis to predict diabetes complications in future. Result:* The results showed that the complication rate has positively influenced the medication cost delivered by the hospital. Furthermore, the increased number of complications has led to the increased number of medication utilization which in turn has raised hospital's operational cost. The Multiple Discriminant Analysis has successfully showed the prediction of diabetes complications with accuracy rate of prediction classification of 62.2%. Therefore, it is regarded as essential to increase additional cost to cover the complication. **Conclusion:** *The finding show that a more preventive measure program should be a key to prevent further complication which in turn would generate more profit.*

Keywords: healthcare cost, hospital profit, Multiple Discriminant Analysis, National Health Security Program.

Introduction

In accordance with the advancement of technology, the changing of lifestyle has been witnessed to grow. Lack of physical activity, less fiber and high calory diets, and smoking has been more prevalent among the people. Studies have shown the correlation between this current phenomenon with the increased prevalence of non-communicable diseases such as hypertension, stroke and diabetes mellitus. Moreover, inadequate management of the diseases, in particular diabetes

mellitus, leads to the increasing number of complications such as heart problems, kidney diseases and stroke^[1].

Currently in Indonesia, in the implementation of the National Security Service (NSS) or Jaminan Kesehatan Nasional (JKN) program, with the Indonesian Case Base Groups, or INA CBG's packaging payment system, the service cost for people with diabetes has been established as a single unit cost regardless the existence of complications. Indeed, the prevalence of complications has served as additional concern for the treatment in diabetes; the more complicated the more complicated the cases, the higher cost are needed. Moreover, the establishment of universal cost for diabetes has proven to be inappropriate which might lead to the possibility of profit loss, especially in complicated cases^[2]. Indeed, participants of the NSS cannot be charged for any cost incur from their conditions, as mentioned in the Government Regulation Number 28 2014 about the implementation guidelines for National Health Insurance Programme^[3].

Therefore, it is regarded important to shed some lights on how the healthcare service cost might influence the development of complications among NSS self-paid participants with type 2 DM in Yogyakarta, and to determine whether multiple discriminant analysis might help to predict the development of complications. The uniqueness of this study lies in the use of multiple discriminants in the scope of medicine in which it is usually used in the scope of biology, and economy.

Literature Review and Hypothesis Development

Inadequate management of diabetes might lead to the development of a wide range of complications both macrovascular or microvascular^{[4][5][6]}. Diabetes has been correlated to the development of atherogenic episodes compared to the non-diabetic, hypertensive, obese or people with lipid abnormality^[7] or to the increased risk of developing ischemic cardiomyopathy^[8] or other severe cardiovascular complications^[9]. Moreover, this condition has also been regarded as the main etiology of the end-stage renal disease chronic kidney disease, non-traumatic amputation or blindness in the United States^[10].

Financial aspect has also been regarded as a major concern in diabetes healthcare delivery. IDF reported for every person with diabetes living in high-income countries, the cost of

healthcare may reach a range of USD5,374 to USD9,641 (ID5,458 to ID9,755) per person^[1].

In UK diabetes care costs approximately £23.7bn in the UK in 2010/2011: £9.8bn in direct cost (£1bn for Type 1 diabetes and £8.8bn for Type 2 diabetes) and £13.9bn in indirect cost (£0.9bn and £13bn) while complications related to the disease account for a substantial proportion of the direct health cost^[11].

In the US, the total estimated cost of diagnosed diabetes in 2017 is \$327 billion, including \$237 billion in direct medical costs and \$90 billion in reduced productivity. Care for people with diagnosed diabetes accounts for 1 in 4 health care dollars in the U.S., and more than half of that expenditure is directly attributable to diabetes^[12]. In Singapore, the mean annual direct medical cost was found to be \$2,034, of which 61% was accounted for by inpatient services, 35% by outpatient services, and 4% by A&E services and the cost of DM treatments and DM related complications were found to be strong determinants of costs^[13]. The care cost mean of diabetes mellitus type 2 per patients with diabetes mellitus type 2 in 2011 was EUR 156.14^[14].

In the low-and Middle income Countries the range falls into USD401 to USD688 (ID765 to ID1,312) per person ^[1], whereas Indonesia shows USD 80.22 per person^[14]. Moreover, according to the data from PT ASKES, previously known as the main agency in delivering health insurance in Indonesia until 2014, people with diabetes without complications cost to USD 40 per year, compared to USD 800 per year for cases with complications ^{[14][15]}.

Therefore, based on above statements, the first hypothesis is: “There is a positive correlation between healthcare cost and type of complications and medication among the self-paid NSS participants with diabetes”.

Multiple Discriminant Analysis (MDA) is a statistical technique that has been applied into various discipline since the first establishment in 1930 ^[16]. Among the earliest users were biology and behavioral sciences who considered the main discipline.

Currently, this procedure has been regarded as one among the most well-known models in business as well as academics. Utilizing Financial Ratio into the model of MDA might predict the possibility of bankruptcy among companies^[17]. In the field of health^[18], the utilization of this model has been shown by? ^[19]in predicting the development of different type of diabetes based from 7 measured variables including patients’ age, weight, height, systolic and diastolic blood pressure, body mass index, and fasting blood sugar^{[19][18][17][16]}.

Therefore, it is hypothesized that “Multiple Discriminant Analysis could be utilized to determine and predict aspects that might influence complications rate among self-paid NSS participants with diabetes type 2”.

Method

The study was a quantitative study to analyze the relationship

between healthcare cost and the type of complications with bivariate analysis and multiple discriminant analyses was utilized to predict the type of complication among people with type 2 diabetes. Empirical Model of Hypothesis Testing Below is the empirical model of the Multiple Discriminant Analysis:

$$Z = W_1X_1 + W_2X_2 + W_3X_3 + W_4X_4$$

Where:

Z = Discriminant Score

W = Discriminant Weight

X₁ = Medication variation (VarObt)

X₂ = Non-insulin medication cost (NonInsulcost)

X₃ = Insulin medication cost (Insulcost)

X₄ = Hospital profit

Results

Table 1. Monthly medication cost according to complications and the percentage cost among self-paid NSS participants with type 2 diabetes in a hospital in Yogyakarta

Complication status	Non-Insulin medication cost		Insulin medication cost		Hospital's Income IDR/month
	IDR/month	%	IDR/month	%	
Without complications	149,956	34	459,863	105	436,089
With 1 complication	264,492	52	529,864	104	508,688
With more than 1 complication	660,317	155	995,233	233	427,183

The results showed the average hospital cost and profit in managing people with type 2 diabetes. Average cost consisted of average cost of non-insulin medication and average cost of insulin medication.

The table 1 shows that medication cost was correlated with the complications’ status, either non-insulin or insulin type of medication. The more complications occurred will lead to the higher of the medication’s cost.

The percentage is refers to the proportion of the medication’s cost to hospital’s profit; the higher the percentage, the less profit hospital will receive. Furthermore, insulin medication’s cost shown to be more expensive compared to non-insulin, and has higher percentage compared to non-insulin. It is also shown that insulin medication’s cost is higher than hospital’s profit, which means loss of profit.

Based from INA CBGs, the hospital will gain a payment package of IDR 165,000 which constitute of specialist consultation’s fee, and medication. Nonetheless, the result also shows that more complications are related to lesser cost than only one complication, which makes the percentage of profit falls lesser.

Bivariate Test

This result shows that the correlation between complications and medication cost and medication's type.

Table 2. Bivariate analysis between complication and hospital's profit and medication's type

	CO MP L	Hospital's profit	NonInsulMed Cost	InsulMed Cost	MedVar	
Spearman's rho	Correlation Coefficient Sig. (2-tailed) N	1.00 .052 58	.052 .699 58	.507** .000 58	.257* .051 58	.432** .001 58
Hospital's profit	Correlation Coefficient Sig. (2-tailed) N	.052 .699 58	1.00 .136 58	.198 .136 58	.640*** .000 58	.203 .126 58
NonInsulMed Cost	Correlation Coefficient Sig. (2-tailed) N	.507*** .000 58	.198 .136 58	1.00 .000 58	.589*** .000 58	.814*** .000 58
InsulMed Cost	Correlation Coefficient Sig. (2-tailed) N	.257* .051 58	.640*** .000 58	.589** .000 58	1.00 .000 58	.589*** .000 58
MedVar	Correlation Coefficient Sig. (2-tailed) N	.432*** .001 58	.203 .126 58	.814** .000 58	.589*** .000 58	1.00 .000 58

***. Correlation is significant at the 0.01 level (2-tailed).

*. Correlation is significant at the 0.1 level (2-tailed).

The table shows that complication rate was correlated with non-insulin medication cost, insulin medication cost and medication variation with the level of significance 0.01, 0.1 and 0.01 respectively. These results supported the first hypothesis which is there was a positive correlation between medication cost and complication's variation and medication's variation. Furthermore, the result shows that complications (COMP) was directly correlated with the medications variation (MedVar) which meant the more complicated the cases, the more medications were needed. Indeed, this would lead to the more medications were needed to be prescribed, which constituted direct cost of hospital operational cost, and lesser profit.

Multiple Discriminant Analysis

Table 3. Function Coefficient of Discriminant Canonical

	Function
	1
VarMed	.676
(Constant)	-2.621

Based on the table above, the discriminant function could be determined as follow by utilizing stepwise method:

$$Z = -2,621 + 0,676 \text{ VarObt}$$

Table 4. Structural matrix on simple correlation between variables and discriminant function.

	Function
	1
VarMed	1.000
NonInsulMed ^a	.523
Insul ^a	.442
Hosprofit ^a	.059

The analysis shows that coefficient structure in this matrix was used to determine the label or the meaning in the function of the discriminant. The result shows that the variation of medication (VarMed) is the label discriminant function which can be used.

Table 5. Fungsi Centroid Group Function/Group Average

COMPL	Function
	1
Type 2 DM without complication	-.419
Type 2 DM with 1 complication	.027
Type 2 DM with > 1 complication	1.770

Table 5 shows that the cutting point of cases classification with group 1 without complication, group 2 with 1 complication and group 3 with more than 1 complication. The centroid score reveals that the variation of medication group as the main source of difference score. Furthermore, the cutting point between group 1 and 2 is -0.0745 (0.5 X (0.027 - 0.419)). This formula, then, reveals a patient would be classified into type 2 DM with 1 complication if Z score ≥ -0.0745, whereas, a patient would go into a group without complication if the Z score was ≤ -0.0745. The cutting point between group 2 and 3 is 0.8715 (0.5 x (1.770 - 0.027)) which means that the patients would be classified as type 2 DM with more than 1 complication if the Z score ≥ 0.8715. While, if the Z score ≤ 0.8715 was classified with type 2 DM with 1 complication.

The establishment of this discriminant function has proven the hypothesis that variation of medication instead of medication cost, able to determine the level of complication in type 2 diabetes between without complication, and with 1 and more than 1 complication. This means that, medication variation was referring to level of complication. This study found that patients with type 2 DM without complication would need 1 - 2 medication variation, whereas 3, 4 or 5 medication variation was referred to type 2 DM with 1 complication, and more than 6 medication variation for type 2 DM with more than 1 complication.

Table 6. Sample analysis for classification of complication

			Predicted Group Membership			Total
			Type 2 DM without complication	Type 2 DM with 1 complication	Type 2 DM with > 1 complication	
Original	COMPL	Type 2 DM without complication	16	7	4	27
		Type 2 DM with 1 complication	11	11	3	25
		Type 2 DM with > 1 complication	0	1	5	6
	%	Type 2 DM without complication	59.3	25.9	14.8	100.0
		Type 2 DM with 1 complication	44.0	44.0	12.0	100.0
		Type 2 DM with > 1 complication	.0	16.7	83.3	100.0
Cross-validated ^a	COMPL	Type 2 DM without complication	16	7	4	27
		Type 2 DM with 1 complication	11	11	3	25
		Type 2 DM with > 1 complication	0	1	5	6
	%	Type 2 DM without complication	59.3	25.9	14.8	100.0
		Type 2 DM with 1 complication	44.0	44.0	12.0	100.0
		Type 2 DM with > 1 complication	.0	16.7	83.3	100.0

The results showed that 59.3% patients with DM would develop without complication, whereas 25.9% patients would have 1 complication and 14.8% would have more than 1 complication. Moreover, the results explained the tendency of complications status among patients with type 2 DM. Forty-four percents of patients with type 2 DM and 1 complication would remain similar, whereas another 44% patients with 1 complication would no longer have complication and 12% patients with 1 complication would develop more complication.

The results also showed that among patients with type 2 DM with more than 1 complication 83.3% would remain in similar circumstances, whereas 16.7% patients would have lesser complication to only 1 complication and none patients would develop to have no complication. The accuracy rate of this prediction classification was found 62.2%, which meant there was a different median between the 3 groups of complication among patients with type 2 DM.

Discussion

The analysis of cost treatment showed, in general, the more complicated were the cases the higher were the cost; both for

non-insulin or insulin treatment. Complications variable was significantly correlated to the non-insulin treatment cost at the significance level of 1% and 10% with insulin treatment cost. Furthermore, the difference between the significance level was referring to the strong direct correlation between oral medication cost and level of complications. Insulin, which was considered expensive treatment, was only prescribed to the clinically required cases. Thus, the results revealed the complication level could be explained by the variation medication; the more complicated were the cases the more medication were needed.

The study also revealed that the multiple discriminant analysis has successfully determined the level of complication among patients with type 2 DM (no complication, 1 or more than 1 complications) with the utilization of medication variation instead of medication cost. In addition, the analysis was also successful in predicting the development of complication's level or the diminishing of complication. The study revealed that there was a greater tendency of developing more complications lesser tendency of diminishing complications. This prediction was found to be accurate with the level of 62.2%.

Inspite of the ability to perform statistical prediction of complication development, Multiple Discriminant Analysis was not able to predict based on clinical analysis. In practice, clinically the development of complication would depend on many factors such as patients' compliance on diet, medication and physical activity, stress management, psychology, and comorbidity. Thus, this limitation would serve as a basis for further longitudinal study in seeking clinical prove based on the development of complication in long term evaluation.

Conclusion and Recommendation

The complication rate has positively influenced the medication cost delivered by the hospital. Furthermore, the increased number of complications has led to the increased number of medication utilization which in turn has raised hospital's operational cost.

Therefore, it is regarded as essential to increase additional cost to cover the complication. Indeed, a more preventive measure program should be the key to prevent further complication which in turn would generate more profit.

References

1. International Diabetes Federation. IDF diabetes atlas. Brussels: International Diabetes Federation; 2015.
2. FITRI E, Andayani TM, FRS S, Suparniati E. ANALISIS BIAYA PENYAKIT DIABETES MELLITUS DI RSUP Dr. SARDJITO YOGYAKARTA. 2015;
3. PMK No. 28 Th 2014 ttg Pedoman Pelaksanaan Program JKN.pdf.
4. Tapp RJ, Shaw JE, Harper CA, De Courten MP, Balkau B, McCarty DJ, dkk. The prevalence of and factors associated with diabetic retinopathy in the Australian population. Diabetes care 2003;26(6):1731–1737.
5. Waspadji, S. Komplikasi Kronik Diabetes: Mekanisme Terjadinya, Diagnosa dan Strategi Pengelolaan. Dalam: Sudoyo, A., Setiyohadi, B., Alwi, I., Simadibrata, M., Setiati, S. ed. Buku Ajar Ilmu Penyakit Dalam. Balai Penerbit FKUI - Jakarta 2006;1884–93.

6. Fowler MJ. Microvascular and macrovascular complications of diabetes. *Clinical diabetes* 2008;26(2):77–82.
7. Creager MA. Diabetes and Vascular Disease: Pathophysiology, Clinical Consequences, and Medical Therapy: Part I. *Circulation* [Internet] 2003 [dikutip 2018 Feb 9];108(12):1527–2. Available from: <http://circ.ahajournals.org/cgi/doi/10.1161/01.CIR.0000091257.27563.32>
8. Hess K, Marx N, Lehrke M. Cardiovascular disease and diabetes: the vulnerable patient. *European Heart Journal Supplements* [Internet] 2012 [dikutip 2018 Feb 5];14(suppl B):B4–13. Available from: <https://academic.oup.com/eurheartjsupp/article-lookup/doi/10.1093/eurheartj/sus002>
9. Grundy SM, Benjamin IJ, Burke GL, Chait A, Eckel RH, Howard BV, et al. Diabetes and cardiovascular disease: a statement for healthcare professionals from the American Heart Association. *Circulation* 1999;100(10):1134–1146.
10. Fauci AS, Harrison TR. *Harrison's manual of medicine* [Internet]. New York: McGraw-Hill Medical; 2009 [dikutip 2018 Feb 9]. Available from: <http://site.ebrary.com/id/10318278>
11. Hex N, Bartlett C, Wright D, Taylor M, Varley D. Estimating the current and future costs of Type 1 and Type 2 diabetes in the UK, including direct health costs and indirect societal and productivity costs: Estimating current and future costs of Type 1 and Type 2 diabetes in the UK. *Diabetic Medicine* [Internet] 2012 [dikutip 2019 Jul 6];29(7):855–62. Available from: <http://doi.wiley.com/10.1111/j.1464-5491.2012.03698.x>
12. Economic Costs of Diabetes in the U.S. in 2017. 2018;41:12.
13. Shuyu Ng C, Toh MPHS, Ko Y, Yu-Chia Lee J. Direct Medical Cost of Type 2 Diabetes in Singapore. *PLoS ONE* [Internet] 2015 [dikutip 2019 Jul 6];10(3):e0122795. Available from: <https://dx.plos.org/10.1371/journal.pone.0122795>
14. Domeikienė A, Vaivadaitė J, Ivanauskienė R, Padaiga Ž. Direct cost of patients with type 2 diabetes mellitus healthcare and its complications in Lithuania. *Medicina* [Internet] 2014 [dikutip 2019 Jul 6];50(1):54–60. Available from: <http://linkinghub.elsevier.com/retrieve/pii/S1010660X14000081>
15. Soewondo P. Harapan Baru Penyandang Diabetes Mellitus pada Era Jaminan Kesehatan Nasional 2014. *eJournal Kedokteran Indonesia* 2014;
16. Soewondo P, Ferrario A, Tahapary DL. Challenges in diabetes management in Indonesia: a literature review. *Globalization and health* 2013;9(1):63.
17. Altman EI. Predicting financial distress of companies: revisiting the Z-score and ZETA models. *Stern School of Business, New York University* 2000;9–12.
18. Altman EI. Financial ratios, discriminant analysis and the prediction of corporate bankruptcy. *The journal of finance* 1968;23(4):589–609.
19. Ghozali Imam. *Aplikasi Analisis Multivariat dengan program SPSS*. Semarang Badan Penerbit UNDIP 2002;Ed 3.
20. Asamoah-Boaheng M. Application of discrimination and classification on diabetes mellitus data. *Int J Appl* 2014;4(6).

Relationship between Knowledge and Physical Activity in Diabetes Melitus Patient

Shinta Wulandari
Faculty of Pharmacy
Ahmad Dahlan university
shintaeswe@gmail.com

Akrom
Faculty of Pharmacy
Ahmad Dahlan University,
akrom@pharm.uad.ac.id

Abstract - Diabetes mellitus has high prevalence which is influenced by several factors, that is lack of knowledge, physical activity and diet. The purpose of this research to look at the relationship between physical activity and knowledge in outpatients with type II diabetes mellitus at the Jets I Health Center, Bantul with Cross Section design with 71 patients as sampel. Data collection was prospective and interviewing using questionnaires of physical activity and knowledge. Data analysis using SPSS, descriptive test with chi square and the significant level of 0,05. There were no significant between knowledge and physical activity with p-value 0,536 > 0,05. There is no statistically significant difference between gender with knowledge and gender with physical activity. The p value in the knowledge group is 0,306 and the physical activity group 0,273.

Keywords : diabetes melitus, counselin phisical activity, knowledge

Introduction

Studies from 91 countries to estimate the prevalence of diabetes national population for 2010 and 2030 said that there will be a 69% increase in prevalence of diabetes national population from 285 million adults in 2010 to 439 million adults in 2030. In Southeast Asia, there will be 72,1% increase in total adult population with diabetes mellitus [1]. Diabetes mellitus (DM) became the disease that caused 5.1 million deaths in 2013 [16]. In Riskesdas in 2018, D. I Yogyakarta had the second highest prevalence of diabetes mellitus in Indonesia, where D.K.I Jakarta kept the first position with 2.6% and D.I Yogyakarta percentage 2.4% [2].

The high prevalence of diabetes mellitus in D.I Yogyakarta, requires further attention to the supporting factors for therapeutic success, including patient knowledge about diabetes mellitus and the physical activity of patients being administered daily. This study aims to see the relationship between knowledge and physical activity of patients with type II diabetes mellitus at Jetis I Health Center, Bantul.

The lack information to understand about the type, duration, and timing of physical activity became a barrier to patient in having a good physical activity [4]. Patients should be given sufficient knowledge about the physical activity that

they are running to be committed so that the ultimate goal is better management of diabetes mellitus.

Literature Review

Diabetes Melitus

The primary type of diabetes are type 1 and type 2. Type 1 diabetes happen from deficient insulin, which is the result from cellular-mediate autoimmune destruction on pancreas β -cells. Type 2 diabetes result from progressive loss of insulin secretion then usually follows by insulin resistance. The type 1 diabetes only exists in 5-10% of diabetes cases and type 2 diabetes occur in 90-95% cases [11].

Knowledge about diabetes

Knowledge and health outcome are having an inconstant relationship. Risk- reducing behavior, not always starting with good knowledge. People will still have unhealthy behaviour while the area having risks [9]. Lack of awareness, knowledge and practical skill about physical activity and health lifestyle is becoming some barrier factor in eighty percent diabetes patients [18]. Another study, shows that patients with better knowledge score also having fewer barriers in controlling blood glucose (r: 0,211; p: 0,006). However Patient with high knowledge in diabetes not always having a good self-care and exercise [19].

Physical activity

All movement that increase energy use, whether exercise planned or structure is called physical activity. Walking, cycling, jogging and swimming are having an energy-producing system as same as on aerobic. Strength training using some machines, body weight improves motion around joints [13]. Recommendations physical activity in diabetes type 2 are, 150 min/week of physical activity and dietary change to lose weight about 5-7%, and daily exercise or exercise with maximum delay interval of 2 days [11].

Methodology

Indonesian adults with diabetes type 2 with complication and without complication who became outpatients of Jetis I Health Center from December 2018 to March 2019. The exclusion criteria are, people with hearing loss (i) patient in insulin treatment (ii) and person with mental disorder (iii). All participants were interviewing one by one with

questionnaires as guidance. The study protocol was approved by Ethic Comitee Ahmad Dahlan University.

Participants

Tabel 1. Descriptive statistic of participant based on control and treatment group

Variabel	Men	Women
N	25	46
weight, mean (SD)	61,2 (11,7)	55 (8,4)
BMI categories, n (%)		
Underweight <18,5	3 (12)	4 (8,7)
Normal 18,5-22,9	10 (40)	18 (39,1)
Overweight 23-24,9	4 (16)	9 (19,6)
Obese I 25-29,9	7 (28)	11 (23,9)
Obese II ≥ 30	1 (4)	4 (8,7)
Duration DM, mean (SD)	6,4 (6)	6,4 (4,6)
Age, mean (SD)	60 (7,6)	59 (9,3)
FBG, mean (SD)	159 (44,8)	157 (51,5)
Complication		
Hypertension, n(%)	11 (44)	18 (39)
Hypercholesterol, n(%)	2 (8)	6 (13)
No complication , n(%)	10 (40)	21 (45,7)
Smoker		
Yes, n(%)	8 (32)	0
No , n(%)	17 (68)	46 (100)
Ex smoker , n(%)	15 (60)	0
Education		
Secondary education or below, n(%)	15 (60)	35 (76)
Tertiary education, n(%)	7 (28)	10 (21,8)
University education or above, n(%)	3 (12)	1 (2,2)

Measures Knowledge

The questionnaires consist of 21 items, that's rated on three options, yes, no and don't know. Score 2 was given in right answer, 1 given in wrong answer and 0 given in don't know. This questionnaire is validation by Gultom in 2012 and refree from knowledge questionnare by Anderson in Australia [19].

Physical activity

This study uses International Physical Activity Questionnaire (IPAQ) short version in the Indonesian form to measure levels of physical activity. The questions about time in respondent using for walking, moderate-intensity and vigorous-intensity activity, that performed minimum 10 minutes per session in the previous 7 days, which count in duration (minutes) and frequency (days) [5]. Calculation the amount of physical activity is done by frequency multiplied by the duration in each physical activity domain, then from the three domains it is summed and gets the results of participant physical activity in one week, which is calculated in MET-call units per week (MET / Cal / week) then classify

into their levels of physical activity: low, moderate, and high. High physical activity considers when consumption was more than 3000 met/Cal/week, then moderate physical activity when consumption of energy between 600 to 3000 met/Cal/ week and when consumption energy per week was lower than 600 met/cal/week [7].

Statistical Analysis

Mean and standard deviation (SD) were presented as descriptive statistics. Knowledge questionnaire was calculated using a percentage. Chi-square analysis were used to find the relationship between physical activity and knowledge. Statistical analyses were performed in SPSS 22.0, then P 0, 05 were considered as statistically significant.

Result and Analysis

Seventy one diabetes melts type 2 patients were enrolled in this study with 25 and 46 women in mean age in a men group was 60 years old and 59 years old in the women group. About 40% participants in a men's group and 39,1% in women's group had normal BMI (18,5-22,9). Eleven participants in the women's group had obese I (BMI 25-29,9) and 4 participants had obese II while in the men's group only 7 participants and obese II (BMI ≥ 30)had 1 participant.

Meanwhile, in a men's group there were still 10 participants with underweight (BMI 18,5) and 18 participants In women's group. Mean values for duration in consuming oral anti diabetes was 6,4 years in both groups.

Table 2 provides the explanation that patients with low knowledge of 19 (26.8%) men and 28 women (39.4%). Then the patient with high knowledge consists of 6 (8.5%) men and 18 (25.4%). Knowledge with a low category has a total of 47 (66.2%) patients and with a high category of 24 (33.8%) patients with a p-value of 0.306 > 0.05. So it can be concluded that there is no significant relationship between knowledge and gender.

Tabel 2. Proportions of knowledge and physical acitivity based on sex in DM Patients Jetis Health Center

	Knowledge		
	Men (n,%)	Women (n,%)	Total (n,%)
Low	19 (26,8)	28 (39,4)	47 (66,2)
High	6 (8,5)	18 (25,4)	24 (33,8)
Total	25 (35,2)	46 (64,8)	71 (100)
P-Value	0,306		
	Physical Activity		
	Men (n,%)	Women (n,%)	Total (n,%)
Low	19 (26,8)	39 (37,6)	58 (81,7)
High	6 (8,5)	7 (8,4)	13 (18,3)
Total	25 (35,2)	46 (64,8)	71 (100)
P-Value	0,273		

In physical activity with a low category, there were 19 (26.8%) and 39 (37.6) female patients with a total of 58 (81.7%) patients. Then in the high category, there were 6 (8.5%) male patients and 7 (8.4%) female patients with a total of 13 (18.3) patients. The p-value of physical activity was $0.273 > 0.05$ so there was no significant association with physical activity with sex.

Tabel 3. Proportions of knowledge and physical acitivity DM Patients in Jetis Health Center

Physical Activity	Knowledge		Total
	Low (n,%)	High (n,%)	
Low (n,%)	38 (53,5)	20 (28,2)	58 (81,7)
High (n,%)	9 (12,7)	4 (5,6)	13 (18,3)
Total	47 (66,2)	24 (33,8)	71 (100)
P-value	0,536		

Patients with low physical activity and low knowledge were 38 (53.5%) people. Then patients with low physical activity but have high knowledge as many as 20 (28.2%) people. Physical activity with a high category and low knowledge has 9 patients (12.7%) then 4 patients (5.6%) with high knowledge and knowledge. The total patients with low and high physical activity were 58 patients (81.7%) and 13 patients (18.3%). The p-value on knowledge and physical activity is $0.536 > 0.05$ by meaning there is no significant relationship between knowledge and physical activity.

Discussion

Table 2 shows that women have higher knowledge (18 patient) than man (6 patient). This result is similar to the study in the middle western-Brazilian city with the conclusion of the study that female patients had higher knowledge about diabetes than men [5]. The p value in the knowledge group is 0.306 and in the physical activity group 0.273 so that it can be interpreted that there is no relationship between gender with knowledge and gender with physical activity.

The category of low physical activity in women has more patients compared to men. In women, there were 39 people with low physical activity and 19 people in men. The results of this study are consistent with the study from kocapte et al where women have low physical activity because women spend more time doing house hold so they cannot take the time to carry out heavy physical activities [20].

Tabel 3 show us that there are no significant relationship between knowledge and physical activity (p-value 0,536). This study result similar to study did in in Iran, where using IPAQ questionnaires for physical activity and using psychological factor such as knowledge, attitudes and self-efficacy. Knowledge of physical activity using 13 items with a score of 1 given to correct opinion, score of zero given two incorrect options (no and I don't know answer). In this study shown that, knowledge didn't have significant association with physical activity (p-value: $0,14 > 0,05$) [6]. Knowledge not always been a motivation on individual in managing diabetes. Knowledge is needed, but not always influences on disease outcomes [8].

In Holmonstorn et al, individuals who had prescribed diabetes regimen, didn't know the reasons behind self-management strategies or the benefit in doing that actions [9]. More knowledge about diabetes influences in consuming healthy foods and lower alcohol consumption, but surprisingly people who know more about diabetes indicate in less physical activity and lead to more stressful live [14].

There were several limitations of our study, first giving counseling to participate until they were fully understood about knowledge in diabetes melitus takes time. Participant just giving information about diabetes melitus once, then there were any measurable to do before counseling was given. For further research about knowledge and physical activity, we recommend to measure the knowledge before giving counseling and after counseling. Second, this study was made in Jetis I Health Center in Yogyakarta, Indonesia with the limitation amount of participant then it can only describe the condition about diabetes patient in Jetis I Health Center.

Conclusion and Recommendation

There is not any significant relationship between gender with knowledge and gender with physical activity but the proportions data show that there are still differences between the men and the women goup.

Acknowledgment

This research was funded by KEMENRISTEKDIKTI (Kementrian Ristek, Teknologi dan Pendidikan Tinggi Republik Indonesia) which is part of the study entitled the modification of pharmaceutical short counseling.

References

- [1] Shaw, J.E., Sicree.R.A., Zimmet P.Z. (2009) Global Estimates of the prevalence of diabetes for 2010 and 2030. *Diabetes research and clinical Practice*, 4-14v
- [2] Badan Penelitian dan Pengembangan Kesehatan (2018) Laporan Nasional Risesdas 2018. Kementrian Kesehatan RI
- [3] Ranasinghe, P., Piger, A.S.A.,Ishara, M.H.,Jayasekara, L.M.D.T.,Jayawaerdena. R., Katulanda, P., (2015) Knowledge and perception about diet and physical activity among Sri Lanka adults with diabetes melitus : a qualitative study. *BMC Public*

Health, 1-10

- [4] Fattahi, A., Barrati, M., Bashirian S., Moghadam R. H., (2014) Physical activity and its related factors among type 2 diabetic patients in Hamadan. Iranian Journal of diabetes and obesity, 85-92
- [5] Forde, C., (2010) Exercise prescription for the prevention and treatment of disease : The University of Dublin
- [6] Heisler M, Piette JD, Spencer M, Kieffer E, Vijan S., (2005), The relationship between knowledge and recent HbA1c values and diabetes care understanding and self management, Diabetes Care
- [7] Anonim (2009). Coaching and Counseling Patients: American College of Preventive Medicine
- [8] Glasgow R. E., (2003) Integrating Self-Management for Chronic Illness and Preventing Behaviors into Health Care. Colorado: Kaiser Permanente
- [9] Colberg S.R., et al (2016) Physical activity/exercise and Diabetes: a position statement of American Diabetes Association, Diabetes Care, 2065- 2078
- [10] Tam C.L., Bonn G., Yeoh S.h., Wong P.C., (2014) Investigating diet and physical activity in Malaysia : education and family history of diabetes relate to lower levels of physical activity, Education, Family history of diabetes, and healthy lifestyle in Malaysia, 1-9
- [11] Shilubane H., Netshuukweta L., Ralibeba T., (2016) Beliefs and practice of diabetic patient in chembe district of limpopo province, African Journal of Primary Health Care & Family Medicine 1-6
- [12] Funnell MM, Brown TL, Childs BP, Haas LB, Hoseney GM, Jensen B, et al (2010), National Standards for diabetes self-management education, Diabetes Care 89-99
- [13] Holmstrom I.M., Rosenqvist U., (2005) Misunderstanding about illness and treatment among patients with type 2 diabetes, Adv Nurs
- [14] Gordon BA, Benson A.C., Bird S.R., et al, (2009) Resistance training improves metabolic health in type 2 diabetes : A systematic review. Diabetes Res Clin Pract
- [19] Gultom Yuni Theodore (2012). Tingkat pengetahuan pasien diabetes mellitus tentang manajemen diabetes mellitus di rumah sakit pusat angkatan darat gatot soebroto jakarta pusat: Skripsi. FKIK Universitas Indonesia
- [20] Kocatepe, Vildan KS. Physical Activity Level and Related Factors of Diabetic Adults According to Gender. International Journal of Caring Science 2017;10(3):1478-1489

The Influence of Evidence Based Practice to Improve Critical Thinking

Dina Alfiana Ikhwan

Lecture of nursing

STIKes Hamzar

Lombok, indonesia

dinaalfianaikhwan@gmail.com

Abstract— Evidence based practice is utilizing of the empirical evidence such as research, clinical expertise, and patient preference. Learning EBP with group discussion approach can be strategic to improve the critical thinking. The purpose of this research was to analyze the influence of the evidence based practice to improve critical thinking undergraduate student. **Method:** Research method was used Quasy Eksperiment pre test and post test without control group design. 61 responden with total sampling were given intervention EBP learning. **Result :** The result of statistical tests with wilcoxon showed there are significant differences in critical thinking students before and after the intervention. The critical thinking was significantly different (with the respective results p value $< 0,05$). **Conclusion:**The application of EBP is significantly to improve critical thinking. It is expected that EBP learning integrated into curriculum in nursing education.

Keywords— Evidence based practice, Critical Thinking,

INTRODUCTION

Background

Entering the second century the learning process experiences a paradigm shift that is globally oriented. Entering the 21st century, the paradigm or direction of the development of education is expected to be able to generate resources capable of implementing programs and resolving conflicts together in a smart, wise and peaceful way[7]. This is in line with the goal of the sustainable development goal (SDG'S) program in 2030 to promote lifelong learning.

expected characteristics of the learning process consist of learning that is interactive, integrative, holistic, scientific, contextual, collaborative, effective and student-centered. The saintfik or scientific approach taken must be based on evidence based. Evidence-based practice is the main competency that nurses must possess to be able to improve service to patients so that it must be integrated into the nursing curriculum [9].

Some experts define evidence based practice as a synthesis or use of empirical evidence which includes research (research), expert opinion, or case reports by considering patient preference or patient choice[3]. The evidence that has been found can be the basis for implementing evidence-based practice to make the best decisions. This is due to the positive impact it has had on both clinical nurses and nursing students who are still studying.

The positive impact of the use of EBP is supported by research [9]. Regarding the impact of evidence-based

practice in empowering RN showing a positive correlation. This is also reinforced by research from [14] which states that the application of EBP competencies in the practice of RN can improve the quality of patients' health, reduce length of care, and reduce patient care costs. In addition, EBP module learning or EBN I in undergraduate nursing students has a positive impact in increasing the confidence and implementation of EBP so that the integration of EBP into the undergraduate student curriculum is very important [15].

However, the ability of nurses and nursing students in finding evidence, analyzing results and their application is still lacking. This is supported by research [15]. which shows that nursing students' knowledge of EBP is still 47.1%. While for undergraduate students, students' understanding of EBP, especially in terms of interpretation, appraisal (assessment) and application of research is still low at 39% [11]. The implementation of EBP learning is applied based on constructivism theory which is an approach used in applying evidence-based practice. In addition, constructivist theory will stimulate students to find information, analyze, and conclude problem solving so that students can improve critical thinking [9].

Critical thinking is the process of critical thinking to achieve goals that will provide reasons based on evidence, conceptualization, context, methods, and criteria[6]. Critical thinking is a component that must be possessed by students in searching for and processing information independently. While the concept of EBP is a strategy to look for evidence or scientific evidence to improve the quality of health services. So that EBP can be a strategy or tool to increase critical thinking.

The results of the preliminary survey at the research institute in this case the Mataram STIKES showed that evidence-based learning practice had not been given although EBP knowledge is very important. so that the ability of students to search for scientific literature or journals was very low. Student results in a number of subjects over the past 3 years have tended to decline. Therefore prospective researchers want to examine the effect of the application of evidence-based practice to increasing critical thinking of nursing students.

Purpose

The purpose of this research is:

a. To Identify critical thinking of nursing student before evidence-based practice learning

b. To Identify critical thinking of nursing student after evidence-based practice learning

c. To Analyze the influence of evidence based practice to improve critical thinking nursing student

Contribution

1. Educational Institutions

This research is expected to provide benefits and provide input for educational institutions in order to be able to integrate evidence-based practice into the curriculum. So that the resulting output is to produce professional nurses who have knowledge and skills that can be realized

2. Nursing students

This research will help students in finding good and relevant literature and up-to-date learning that is very much needed for learning processes or discussion processes or making scientific papers and applying them in nursing care or nursing practice.

3. Nursing lecturer

This research can be additional information about EBP for educators that can be used as a reference in EBP learning.

Research result and implication

EBP learning is very important to be integrated in nursing curriculum.

Literature review

Evidence based practice (EBP) is a process that will help health workers to be able to update or ways to be able to obtain the latest information that can be used as material to make effective and efficient clinical decisions so that they can provide the best care to patients [12]. Whereas according to [4] evidence based practice is a strategy for obtaining knowledge and skills to be able to increase positive behavior so that it can apply EBP in practice. From the two terms of EBP, it can be understood that evidence based practice is a strategy to obtain the latest knowledge or knowledge based on evidence or clear and relevant evidence to make effective clinical decisions and improve skills in clinical practice to improve the quality of patient health. The definition, the main component in health education institutions that can be used as a principle is making decisions based on evidence based and integrating EBP into the curriculum is very important.

In line with the development of the health care system, the change towards patient-center-care has an impact on various efforts to improve the quality of patients' health. Such efforts include the use of evidence based practice concepts to integrate evidence based practice and practice based evidence. To realize this, the competence that is needed by a nurse is critical thinking. Critical thinking is the process of critical thinking to achieve goals that will provide

reasons based on evidence, conceptualization, context, methods, and criteria [6]. Whereas according to [10] critical thinking is an active mental process in analyzing, synthesizing and evaluating information both from the results of observations, experiences, finding causes, and processing information sharing to be applied in the form of actions or actions. Therefore, a good critical thinker is someone who always has the desire and motivation to "move" or move into a better situation by using evidence or strong evidence to make decisions and achieve goals.

METHODOLOGY

The research method used is Quasy Experiment research pre test and post test without control group design. This research was conducted on 1-31 March 2018. It is conducted for one month.

The sample used was all Bachelor of Nursing study program students, semester 8, University of Muhammadiyah Yogyakarta 2017/2018 academic year totaling 61 people. Sampling technique uses total sampling. The inclusion criteria of this study is the students who had received research methods and active in attending class.

Respondents were given interventions in the form of evidence-based training and learning practice. The training was carried out for 4 hours with training material, namely the presentation of evidence based nursing concepts or evidence based practice which included the evidence based evidence or practice, level of evidence, PICO, search literature, how to find relevant findings, and the stages in evidence based practice and role play implementing learning stages of evidence based practice with 4 cases. There are pretest and posttest before and after training.

During the study there were 8 students who dropped out. The instrument used is a Critical Thinking questionnaire that was constructed by the researcher himself and has been expert tested and validity tested. Bivariate analysis by Wilcoxon. Ethical principal in this research is self determination, privacy and dignity, anonymity, and fair treatment.

RESULT

Analysis of the characteristics of respondents in this study using frequency distribution analysis

based on age, gender, ethnicity and marital status are illustrated in the table below

Table 1 Distribution of frequency characteristics of respondents based on age and sex (N=61).

Category	Intervention group		P
	N=61	percent	
Gender			
Man	22	36%	0.806
Woman	39	64%	
Age			
≤20 old	10	16%	0.523
21-25 old	51	84%	

Based on the table, it can be seen that the majority of the sexes of the respondents were women, namely 39 people (64%). While for the age of the respondents, the majority

are 21-25 years, which is 51 people 84%. As for the statistical test results P value > 0.05.

Table 2 The critical thinking level before and after the intervention (N=61)

Variabel group	Level of <i>critical thinking</i>				P value
	Good	%	Poor	%	
	N=61	%	N=61	%	
Pretest	23	37.1	38	61.3	0,00
posttest	32	52.5	29	47.5	

From table 4.2 the results show that there is a difference or increase in critical thinking before and after intervention. Before the intervention, the critical thinking level of respondents in the good category was 23 people, after the intervention there was an increase to 32 people. Whereas for

the category of critical thinking level, it declined less than 38 people to 29 people. And P value 0,00 that means there are influence of evidence based practice to improve critical thinking.

Discussion

1. Characteristics of respondents Based on the results of recapitulation of research data, Based on table 1, it was found that the proportion of female respondents was greater than the number of male respondents. Female sex numbered 39 respondents or 64%. However, P 0.806 shows that the difference in the number of men and women is not a factor that influences students' critical thinking. This is consistent with research in Iran [16], which proves that there is no significant difference between men and women in critical thinking levels. In addition, this is supported in research [17] which states that although gender differences are very synonymous with differences in life style and differences in orientation, both men and women have critical thinking skills that tend to be the same. This ability is obtained from the ability to identify and justify almost the same. So that it can be concluded, the differences in men and women are not the main thing that supports respondents' critical thinking skills.

In this study, the proportion of respondents' ages showed relatively similar results. Part of the age of respondents is 21-25 years, namely 51 respondents or 84%. The level of thinking and emotional maturity of individuals is often associated with the level of maturity of age. Increasing age will improve experience in solving problems, and take important and best decisions in life. The

mature age is expected to have more roles and responsibilities towards the social. However, maturity is a choice. Because of several factors such as culture, family, environment or personal choices that helped shape maturity itself. Therefore, a person's maturity is not always accompanied by thinking maturity [2].

This is in accordance with the research [1] which shows that there is no significant relationship between age and the level of critical thinking. Critical thinking is an active process. Every time you find a problem, critical thinking is how to form a question before accepting new ideas or ideas as a solution to the problems found. Each will make a decision, then at that moment critical thinking starts. Critical thinking is the main fundamental goal of the educational process in a higher level. This is also supported by research [14] which shows that the increasing problems that arise in nursing practice and the increasing needs of patients, the nursing environment is demanded creative, innovative, analytical, and have good critical thinking. Age is not a factor the main thing that can improve or support one's thinking critical.

Based on the results of the study, with the level of significance (P = 0.523) which means there is no relationship between age and students' critical thinking. This is due to the age of the respondent according to the level of education undertaken.

2. Critical thinking before and after intervention The results of this study can show an increase in critical thinking in a number of respondents. Before intervention, the critical thinking level of respondents in the critical thinking category was 23 people (37.1%) and the poor category was 38 people (61.3%). After intervention, respondents who belonged to the category of critical thinking good increased to 32 people (52.5%) while those in the less category dropped to 29 people (47.5%). These results indicate that the application or learning of evidence based practice with a group discussion approach can increase student critical thinking. In research [17] shows that EBP learning using the active learning strategies approach is more effective than using *deductive teaching strategies*. EBP learning process actively such as group discussion and self direct learning can increase the level of ability to solve problems, the level of independence in learning, and also the ability of students to communicate and cooperate so as to increase learning satisfaction for students[13]. Unlike the case with EBP learning by using lectures or teacher centers, students' ability to raise clinical questions and seek evidence or journal articles tend to be low. Learning evidence based practice is a component that should be integrated into the nursing curriculum. EBP learning is very important because it is the first step in preparing students to become professional nurses. EBP learning undergraduated focused on 4 of the 5 main steps, because projects are based on scenarios and students are not asked to implement the best interventions. The EBP process includes ask, acquire, appraise, apply, and assess[14]. While [10] explains critical thinking is a combination of several skills including the ability to read and listen carefully, evaluate arguments or opinions, find and find hidden assumptions, and understand the consequences that might occur. Based on [8] In the world of nursing, with the increasing challenges to always

CONCLUSION

Based on the results of the study it can be concluded that there is a significant difference in the median value of critical thinking of students before and after the application of EBP learning conducted with 1 training and 4 cases of group discussion. In this research p value is 0,00, so thats

REFERENCES

- [1] Afsahi, S. E., & Afghari, A. (2017). The Relationship between Mother Tongue, Age, Gender and Critical Thinking Level. *Journal of Applied Linguistics and Language Research*, 4(1), 116–124.
- Belden, Catherine., Leafman, joan., Nehrenz,guy., Miller, patricia. (2012) The effect of evidence-based practice on workplace empowerment of rural registered nurses. *Journal of rural nursing and health care*
- [2] Benson, J. E., & Elder Jr, G. H. (2011). Young adult identities and their pathways: A developmental and life course model. *Developmental psychology*, 47(6), 1646.
- [3] Boström, A.-M., Rudman, A., Ehrenberg, A., Gustavsson, J. P., & Wallin, L. (2013). Factors

provide quality health services, the ability to critical thinking and make effective decisions is needed. In nursing education, strategies or efforts to increase critical thinking are very dependent on the learning approach used. While according to [12]critical thinking is a key component in nursing, education and knowledge practice. Basically the critical thinking disposition consists of inquisitiveness, truth seeking, self-confidence, analyticity, systematicity, and maturity. So that students who have good critical thinking are usually characterized by good grade point average (GPA) scores. in addition, students who have a good critical thinking disposition will have the ability to analyze the situation systematically

. Before the discussion began, respondents in this study were given an evidence based practice module so that respondents could understand the flow of research, the steps of learning or discussion, along with the case first. So that respondents have good preparation in following the discussion. Students can learn independently (self direct learning) or joint discussion (group discussion). Before the discussion begins, students actively practice looking for references in the form of journal articles according to cases that might be used in the discussion. So that students become more active in discussions because students have longer preparation times and because references used are more up-to-date and varied.

Unlike the case, with the implementation of the discussion before being given learning evidence based practice, students tend to be less active because of lack of preparation and distress in finding up-to-date sources. Students are more motivated to conduct searching journals and are more open in accepting new knowledge and have the ability to maintain arguments based on evidence that has been found. So that evidence based practice learning with a group discussion approach can spur students' critical thinking.

means there are influence of evidence based practice to improve critical thinking of nursing student.

This research can be input in educational institutions to integrate evidence-based practices into the curriculum using active learning method approach.

associated with evidence-based practice among registered nurses in Sweden: a national cross-sectional study. *BMC Health Services Research*, 13(1), 165.

- [4] Bostwick, L. 2013, *Evidence-Based Practice Clinical Evaluation Criteria for Bachelor of Science in Nursing Curricula*, College of Saint Mary
- [5] Burns, N., & Grove, S. K. (2008). *The practice of nursing research: Appraisal, synthesis, and generation of evidence*. Saunders.
- [6] Cone, C., Godwin, D., Salazar, K., Bond, R., Thompson, M., & Myers, O. (2016). Incorporation of an Explicit Critical-Thinking Curriculum to Improve Pharmacy Students' Critical-Thinking Skills. *American Journal of Pharmaceutical Education*, 80(3), 41. <http://doi.org/10.5688/ajpe80341>

- [7] Dikti (2014). Buku kurikulum pendidikan tinggi. Direktorat Jenderal Pendidikan Tinggi RI. Jakarta
- [8] Guyatt, G., & Rennie, D. (2002). Users' guides to the medical
- [9] Kibui, P. G. (2012). A critique of the contribution of constructivist learning approaches to the development of critical thinking. *Unpublished Master Thesis*. University of Nairobi, Kenya.
- [10] Kim, K., Sharma, P., Land, S. M., & Furlong, K. P. (2013). Effects of active learning on enhancing student critical thinking in an undergraduate general science course. *Innovative Higher Education*, 38(3), 223-235.
- [11] Leach, M. J., Hofmeyer, A., & Bobridge, A. (2016). The impact of research education on student nurse attitude, skill and uptake of evidence-based practice: a descriptive longitudinal survey. *Journal of Clinical Nursing*, 25(1-2), 194-203. <https://doi.org/10.1111/jocn.13103>
- [12] Macnee CL, McCabe S. (2011) Understanding nursing research: Using research in evidence-based practice. Philadelphia: Williams & Wilkins.
- [13] Mehrdad, N., Joolace, S., Joulace, A., & Bahrani, N. (2012). Nursing faculties' knowledge and attitude on evidence-based practice. *Iranian Journal of Nursing and Midwifery Research*, 17(7), 506-511.
- [14] Melnyk, B. M., Gallagher-Ford, L., Long, L. E., & Fineout-Overholt, E. (2014). The establishment of evidence-based practice competencies for practicing registered nurses and advanced practice nurses in real-world clinical settings: proficiencies to improve healthcare quality, reliability, patient outcomes, and costs. *Worldviews on Evidence-Based Nursing*, 11(1), 5-15.
- [15] Reid, J., Briggs, J., Carlisle, S., Scott, D., & Lewis, C. (2017). Enhancing utility and understanding of evidence based practice through undergraduate nurse education. *BMC Nursing*, 16(1). <https://doi.org/10.1186/s12912-017-0251-1>
- [16] Salahshoor, N., & Rafiee, M. (2016). The Relationship between Critical Thinking and Gender: A Case of Iranian EFL Learners. *Journal of Applied Linguistics and Language Research*, 3(2), 117-123.
- [17] Zetriuslita, H., Ariawan, R., & Nufus, H. (2016). Students' Critical Thinking Ability: Description Based on Academic Level and Gender. *Journal of Education and Practice*, 7(12), 154-164

Quality of Life in Hemodialysis Patients with Chronic Kidney Disease

Virgianti Nur Faridah

Universitas Muhammadiyah Lamongan, Indonesia,
virgianti_nf@yahoo.com

Trijati Puspita Lestari

Universitas Muhammadiyah Lamongan, Indonesia,
pipid.puspita@gmail.com

Isni Lailatul Maghfiroh

Universitas Muhammadiyah Lamongan, Indonesia,
isni.lailatul@gmail.com

Lora Permata Ariyastuti

Universitas Muhammadiyah Lamongan, Indonesia,
lorapermata@gmail.com

Abstract -- Chronic kidney disease (CKD) and its treatment have an important part in forming the QoL of patients who have hemodialysis. As a result, CKD affects the quality of life from the physical, psychological, social and environmental dimensions. A descriptive analytic study was conducted in the hemodialysis unit of the RSUD Dr. Soegiri Lamongan. A total of 88 CKD's patients with hemodialysis were studied. Patient's QOL was rated by WHOQOL-BREF questionnaires. The results showed that in the domain of quality of life, the low domain was physical with an average of 20 and the high domain was social with an average of 10. While most respondents with high quality of life as many as 78 people (88.6%) and a small respondent with medium quality of life as many as 10 people (11.4%). The results of this study can be concluded that most respondents have a high quality of life. However, the physical condition of CKD patients has significant problems. Thus, given the information by the hospital to overcome the physical disturbances that occur in CKD patients, so that his quality of life improved

Keywords—Chronic Kidney Disease, Quality of Life, Hemodialysis

INTRODUCTION

Chronic Kidney Disease (CKD) are among the main health problems around the world that influence quality of life and patient's lifestyle [1]. Quality of life is one of the main indicators for general well-beings [2]. Quality of life is turn out to be a trusty predictor for short and long term mortality in many pathological conditions [3], such as CKD [4].

End stage of renal disease patients in undergoing hemodialysis usually think that they are free to intake of water and food. Because after hemodialysis their health will be better with frequent visits to the center of dialysis and had a needle prick. They didn't understand that the progress of disease and complications related to their bad habits. Two study findings show that about half of patient's hemodialysis has not changed in the quality of life, while a quarter reported increase and the rest has experienced a fall in the quality of life [5], [6].

Chronic Kidney Disease is the important morbidity and mortality around the world. According to the study Global Burden of Disease (2013), CKD contributed 956.200 death around the world that rises around 134 % of 1990 [7]. Indonesia is a country with a high level of CKD sufferers, the Indonesian Nephrology Association (PERNEFRI) estimates that there are 70,000 people with CKD in Indonesia. This number will continue to increase by around

10% every year [8]. While based on data from the 2013 Basic Health Research (Riskesdas), the prevalence of CKD in Indonesia was 0.2% from the total diagnosis [9]. Based on the initial survey conducted by researchers at the RSUD Dr. Soegiri Lamongan obtained a total of 455 patients visiting CKD in 2015.

Assessment of health-related quality of life as a prediction indicators from the disease and hundreds of thousands that can be used in assessing the effectiveness of intervention therapy and survival of patients [10] [11]. The act of hemodialysis consisting of the procedure complex for patients who do visited to the hospital or center dialysis that it is often so have caused the changes substantial in the manner of normal life patients CKD [12] [13]. The purpose of this research is to explore the quality of life are patients CKD undergoing hemodialysis.

METHODS

Design and Patients

This descriptive analytic stud was conducted Maret 2017 in hemodialysis unit of the RSUD Dr. Soegiri, Lamongan city, Indonesia. The population on this study were all patient diagnosed CKD undergoing hemodialysis. The sampling method in this study was conducted using total sampling technique. A total of 88 patients CKD with hemodialysis were studied.

Instrument

Quality of Life (QoL) was measured using WHOQOL-BREF questionnaires. This has fourth domain, namely physical, phsicology, social relationship and environment. Physical domain has seven item question, phsicology domain has six item question, social relationship domain has three item question, and environment domain has eight item question [14]. In addition there are also two additional questions at the beginning, namely about feelings about quality of life and feelings about health. Total questions are 26 item, each item questions are scored from 5 to 1.

Statistical Analysis

The data obtained were analyzed descriptively and quantitatively. Data analysis is done with assistance SPSS statistical software version 22.

RESULT AND ANALYSIS

Result

The highest average quality of life score is in the social domain of 10 with a minimum value of 6 as many as 2

respondents and a maximum value of 14 as many as 2 respondents. And the lowest average quality of life score is in the physical domain of 20 with a minimum value of 12 as many as 2 respondents and a maximum value of 27 by 2 respondents (Table 2). The majority of respondents with a high quality of life were 78 people (88.6%), and a small proportion of respondents with moderate quality of life were 10 people (11.4%) (Table 3).

Table 1. Respondent Characteristic

Respondent Characteristic	Frequency	Percentage (%)
Age		
20-30 years old	6	6,8
31-40 years old	10	11,4
41-50 years old	35	39,8
51-60 years old	37	42,0
Gender		
Male	45	51,1
Female	43	48,9
Educational Degree		
Didn't school	3	3,4
Elementary	28	31,8
Junior High School	19	21,6
Senior High School	22	25,0
Bachelor	16	18,2
Occupational Distribution		
No Job	26	29,5
Entrepreneur	21	23,9
Government employees	14	15,9
Farmer	27	30,7

Table 2. The quality of life of patients CKD undergoing hemodialysis at RSUD Dr. Soegiri Lamongan based on the Domain in WHOQOL-BREF Questionnaires

Domain QoL	Score	Mean	Value	
			Min.	Max.
Physical	35	20	12	27
Environment	40	26	14	40
Psychological	30	12	7	27
Social	25	10	6	14

Table 3. The Level of quality of life of patients CKD undergoing hemodialysis at RSUD Dr. Soegiri Lamongan

QoL	Frequency	Percentage (%)
Low	0	0
Moderate	10	11,4
High	78	88,6
Total	88	100

Analysis

The kidneys function is to regulate the balance of water in the body, regulate the concentration of salt in the blood, and balance the acid-base blood, and excretion of waste materials and excess salt. If the kidneys fail to carry out their functions, the patient needs immediate treatment. The situation in which the kidneys gradually begin to not function properly is also called Chronic Kidney Disease (CKD) [15].

According to the Kidney Disease Outcome Quality Initiative recommends that there are 4 stage of CKD based on the rate of decrease in Glomerular Filtration Rate (LFG). 1st Stage: Kidneys abnormalities characterized by persistent albumin and normal LFG (>90 ml/minute/1.73 m2). 2nd Stage: Kidney abnormalities with persistent

albumin and LFG between 60-89 mL/minute/1.73 m2). 3rd Stage: kidney abnormalities with LFG between 30-59 mL/minute/1.73 m2), Stage 4: kidney abnormalities with LFG between 15-29mL/ minute/1.73 m2) Stage 5: kidney abnormalities with LFG <15 mL/minute/1.73 m2 or terminal renal failure [16].

CKD's patients who experience chronic kidney failure will undergo long-term hemodialysis. Hemodialysis is a procedure that the blood is removed from the patient's body and circulates in a dialiser. The frequency of hemodialysis varies depend on the stage of CKD. Average the patient undergoes hemodialysis are three times a week, while the duration of the implementation of hemodialysis is at least three to four hours every once hemodialysis [17].

CKD patients was over 40 years old with the highest number (42%) in the age range of 51-60 years old. Basically CKD can occur at all ages, but higher the age, the higher risk of systemic diseases. One of which is diabetes mellitus and hypertension which is the most common cause of CKD. Nonetheless, there are still CKD patients under the age of 40 with varying causes such as taking steroids for a long time, kidney inflammation or other kidney disease, and systemic lupus erytomatosus (SLE).

Age influences a person's perspective on life, future and decision making. Patients in productive age feel more motivated to recover because they have high life expectancy and are the most important member of role for family's income. Elderly patients tend to leave decisions to their immediate family. This will affect how patients seek health services in order to correct their physical complaints. Their gender is almost balanced between men and women with a percentage of 51.1% and 48.9%. This shows that CKD can occur in both men and women. Although in diseases that cause CKD (DM and Hypertension) have a tendency to occur in men, but in elderly the risk of this disease will increase in both men and women because a decrease in cell function [18].

The most (31.8%) recent education in CKD patients was elementary school. From these data indicate that they have a low level of education. The level of education plays an important role in determining a person's health status. Low education levels tend to have a low level of knowledge. Patients with chronic diseases have considerable challenges in managing clinical manifestations that appear as long as they live. Management of chronic diseases requires good knowledge and abilities so that they can improve their quality of life.

Education also influences how patients make prevention so that the prognosis of the disease does not get worse. A high level of education tends to be easier to understand information about the disease and its management. While a low level of education can result in someone having low knowledge about his health. This can worsen the physical condition of someone who is sick. Patients with higher education have broader knowledge, so that patients can control themselves in overcoming problems, have high self-confidence, experience, and have the right estimates in dealing with events, and easy to understand about what is recommended by health workers.

Most (30.7%) of them are farmers, but quite a lot (29.5%) of them do not work. A person's work indirectly can lead to an unhealthy lifestyle. Stress, fatigue, consumption of supplement drinks, consumption of herbs and dangerous drugs, foods containing preservatives, and lack of drinking water can be a trigger factor for various kidney problems. For example, that often occurs in society is the habit of drivers who consume supplement drinks to maintain energy. Consumption of these drinks for a long time will cause damage to the kidneys. In addition, consumption of herbs and drugs containing steroids without control is also a cause of CKD.

The lowest quality of life domain is the physical domain because during hemodialysis the respondent feels physical weakness that can occur due to anemia. Anemia is a cause of decreased physical function and mental disorders in patients CKD. Research shows that efforts to cure anemia will improve cognitive function, sexual function, general well-being, and quality of life [19]. Anemia that occurs in patients CKD undergoing hemodialysis can cause a decrease in quality of life and increase mortality, depressed immunity, reduced exercise capacity due to lack of energy, and reduced cognitive abilities [20]. Finklestein et al. conducted a study of the relationship between Hb levels and quality of life and found that Hb levels were related to quality of life. In this study also found that an increase in Hb levels can significantly improve the quality of life dimensions of physical health and health [21].

While the highest quality of life domain is the domain of social relations caused by chronicles and old according to social relations, respondents are already quite good because they are able to adjust to the social domain quite high. In addition, with good support in terms of family, friends, finance and the environment improve the quality of life for patients CKD [22]. According to Smeltzer & Bare, family support is part of social relations in providing support or help and assistance to family members who are supporting HD [18]. Germin et.al, states that patients with long-term HD more than one year will have lower physical and social functioning than less than one year [23].

The quality of life of patients as low make therapy correctly. Half of the patient's hemodialysis tending to fail to comply with the intervention [24]. Health professional would have had to develop intervention individually to boost compliance patients against regimen the treatment of cases decisions are made by. The quality of life of that it is more highly make patients are not the face of difficulties with their families or a social environment. According to Barnett et al., CKD affects both patients and their families due to the extensive lifestyle changes as well as fluid and dietary restrictions [25].

World Health Organization (WHO) defines quality of life as the individual perception about their position in life in the context of culture and value system and related to the purpose, hope, standard and their concern in their live [14]. CKD's patients undergoing dialysis are more sensitive to infections because of general frailty and depression in immunologic system and signs and symptoms of infection can be prevented by drug therapy [26]. Poor general health conditions are often associated with poor quality of life [27].

CKD can affect the quality of life of patients which can be observed in the social, environmental, physical, and psychological domains. the severity of the symptoms and the duration of the disease make it important to evaluate patient's quality of life [28].

QoL in CKD is an important thing that needs to be managed. Prolong survival of patients CKD is an important intervention. It has equal importance with given toward maintain of QOL [28]. QoL assessment in CKD's patients has become more important. This is to evaluate the influence of the disease and the renal replacement therapy they needed. QoL in CKD's patients with dialysis overall had low scores in all domains. Age, gender, level of education, employment status, and duration of disease diagnosed was affected domains of QoL [29],[30].

CONCLUSION AND RECOMMENDATION

Conclusion

The results of this study can be concluded that most respondents have a high quality of life. However, the physical condition of CKD patients have significant problems. Thus, given the information by the hospital to overcome the physical disturbances that occur in CKD patients, so that his quality of life improved.

Recommendation

Management of CKD must include QoL assessment and management. To increase kidney function is ckd patients with renal replacement therapy have to consider the needs and expectations. individual patientsIn addition, patients receiving hemodialysis action must be received psychological treatment, especially those who show, emotional problems to achieve better results in therapy and improve the quality of their lives. Family support may be important in improving the quality of life of CKD patients undergoing hemodialysis therapy

ACKNOWLEDGMENT

Spesial thanks to nurses at Hemodialysis Departement in RSUD Dr. Soegiri Lamongan.

REFERENCES

- [1] Ghiasi, B., Sarokhani, D., Dehkordi, A. H., Sayehmiri, K., & Heidari, M. H. Quality of Life of patients with chronic kidney disease in Iran: Systematic Review and Meta-analysis. *Indian journal of palliative care*. 2018;24(1), 104–111.
- [2] Kendrick, T. et al. Routine use of patient reported outcome measures (PROMs) for improving treatment of common mental health disorders in adults. *The Cochrane database of systematic reviews* 7; 2016.
- [3] Diouf, M. et al. Could baseline health-related quality of life (QoL) predict overall survival in metastatic colorectal cancer? The results of the GERCOR OPTIMOX 1 study. *Health and quality of life outcomes*. 2014: 12-69.
- [4] Porter, A. C. et al. Predictors and Outcomes of Health-Related Quality of Life in Adults with CKD. *Clinical journal of the American Society of Nephrology: CJASN*. 2016;11, 1154–1162.

- [5] Liebman, S., Li, N. C. & Lacson, E. Change in quality of life and one-year mortality risk in maintenance dialysis patients. *Quality of life research: an international journal of quality of life aspects of treatment, care and rehabilitation*. 2016;25, 2295–2306.
- [6] Perl, J. et al. Association between changes in quality of life and mortality in hemodialysis patients: results from the DOPPS. *Nephrology, dialysis, transplantation: official publication of the European Dialysis and Transplant Association - European Renal Association*; 2016.
- [7] Naghavi M, Wang H, Lozano R, et al. GBD 2013 Mortality and Causes of Death Collaborators. Global, regional, and national age-sex specific all-cause and cause-specific mortality for 240 causes of death, 1990–2013: a systematic analysis for the Global Burden of Disease Study 2013. *Lancet*. 2015;.385(9963):117–171.
- [8] PERNEFRI (Perhimpunan Nefrologi Indonesia). Naskah Lengkap : Simposium Peningkatan Pelayanan Hemodialisis, Penyakit Ginjal dan Aplikasi Indonesian Renal Registry Joglosemar 2012. PERNEFRI. Yogyakarta; 2013.
- [9] Kemenkes RI. Riset Kesehatan Dasar; RISKESDAS. Jakarta: Balitbang Kemenkes RI; 2013.
- [10] Unruh ML, Hess R. Assessment of health-related quality of life among patients with chronic kidney disease. *Adv Chronic Kidney Dis*. 2007;14(4): 345-352.
- [11] Kaufman SE. The increasing importance of quality of life research. *Clin Res*. 2001;1: 18-22.
- [12] Avramovic M, Stefanovic V. Health-related quality of life in different stages of renal failure. *Artif Organs*. 2012;36(7):581-589.
- [13] Landreneau K, Lee K, Landreneau MD. Quality of life in patients undergoing hemodialysis and renal transplantation - a metaanalytic review. *Nephrol Nurs J*. 2010;37(1): 37-44.
- [14] World Health Organization. The World Health Organization Quality of Life (WHOQOL) Geneva, Switzerland: World Health Organization; 1997.
- [15] Kazama, et al. The Risk of Gallbladder Stone Formation Is Increased in Patients with Predialysis Chronic Kidney Disease but Not Undergoing Chronic Hemodialysis therapy. *Nephron Clin Pract*. 2009:111.
- [16] Parwanti, Pebriyana. Hubungan Dukungan Keluarga Dengan Kualitas Hidup Pasien Hemodialisa Di RS PKU Muhammadiyah Yogyakarta unit II; 2015.
- [17] Brunner & Suddarth. Buku Ajar Keperawatan Medikal Bedah Edisi 8 volume 2. Jakarta : EGC; 2013.
- [18] Smeltzer, S. C., & Bare B. G. Buku Ajar Keperawatan Medikal Bedah Brunner & Suddarth (Edisi 8 Volume 1). Jakarta: EGC; 2009.
- [19] Drüeke TB, Locatelli F, Clyne N, Eckardt KU, Macdougall IC, Tsakiris D., et al. Normalization of Hemoglobin Level in Patients with Chronic Kidney Disease and Anemia. *N Engl J Med*. 2006: 355(20): 2071-84.
- [20] Clement FM, Klarenbach S, Tonelli M et al. The impact of selecting high hemoglobin target level on health related quality of life for patients with chronic kidney disease. *Arch Intern Med*. 2009: 16(9):1104-1112.
- [21] Finkelstein FO, Story K, Firanek C, et al. Health-related quality of life and hemoglobin levels in chronic kidney disease patients. *Clin J Am Soc Nephrol*. 2009;4:33-38.
- [22] Nurchayati, S. Analisa faktor-faktor yang berhubungan dengan kualitas hidup pasien penyakit ginjal kronik yang menjalani hemodialisa di Rumah Sakit Islam Fatmawati Cilacap dan Rumah Sakit Umum Daerah Banyumas. Tesis, Universitas Indonesia, Depok; 2010.
- [23] Germin-Petrovic D, Devcic I, Lesac A, Mandic M, Soldatic M, Vezmar D. Health related quality of life in the patients on maintenance hemodialysis: the analysis of demographic and clinical factors. *Coll Antropol*. 2011;3:687-93.
- [24] Kutner NG. Improving compliance in dialysis patients: does anything work? *Semin Dial*. 2001;14(5): 324-327.
- [25] Barnett T, Li Yoong T, Pinikahana J, Si-Yen T. Fluids compliance among patients having hemodialysis: can an educational program make a difference?. *J Adv Nurs*. 2008;61(3): 300-306
- [26] Hamissi J, Porsamimi J, Naseh MR, Mosalaei S. Oral hygiene and periodontal status of hemodialyzed patients with chronic renal failure in Qazvin, Iran. *East Afr J Public Health*. 2009: 6(1):108–111
- [27] Feroze U, Noori N, Kovesdy CP, Molnar MZ, Martin DJ, Reina Patton A, Benner D, Bross R, Norris KC, Kopple JD, Kalantar-Zadeh K. Quality-of-life and mortality in hemodialysis patients: roles of race and nutritional status. *Clin J Am Soc Nephrol*. 2011;6(5):1100–1111
- [28] Beiber, SD & Himmelfarb, J. Hemodialysis. In *Schrier's Disease of the Kidney*. 9th Edition. Editors Coffman, T.M., Falk, R.J., Molitoris, B.A., Neilson, E.C., Schrier, R.W. Philadelphia: Lippincott Williams & Wilkins; 2013. P. 473-505.
- [29] Cukor D, Ver Halen N, Fruchter Y, Kimmel PL. Psychosocial issues in chronic kidney disease patients. *Chronic Renal Disease*. 2014: 229–236.
- [30] Ferreira RC, da Silva Filho CR. Quality of life of chronic renal patients on hemodialysis in Marília, SP, Brazil. *J Bras Nefrol*. 2011;33(2):129–135

Exploration of Elder Neglect by Family on The Islamic Perspective in Kalirandu Village

1st Nadya Lestari

Department of Community in Nursing
School of Nursing, Faculty of Medicine and Health Science
Universitas Muhammadiyah Yogyakarta
Special Region of Yogyakarta, Indonesia
nadyalestari22@gmail.com

2nd Dinasti Pudang Binoriang

Department of Community in Nursing
School of Nursing, Faculty of Medicine and Health Science
Universitas Muhammadiyah Yogyakarta
Special Region of Yogyakarta, Indonesia

Abstract— *An increase in the elderly population will cause the elderly to be at risk of experiencing health problems, one of which is a problem experienced in the family that is neglect. Neglect is one of the most common acts of mistreatment for families towards the elderly in meeting their physical and mental health needs. The family has a very important role in meeting the needs of the elderly, but the perpetrators of neglecting the elderly are found more in family members. In accordance with the teachings of Islam which views the elderly with high respect and teaches to treat the elderly well, so that their existence is not considered a burden on the community, especially the family. This study is to identify the incidence of elder neglect by the family on the Islamic perspective in village of Kalirandu. The results of the study showed that all participants knew about how to care for parents who were elderly in an Islamic perspective. The obligation of child is to help parents fulfill their needs, in other words children are obliged to provide for the parents.*

Keywords— Family; Elderly; Elder Neglect.

I. INTRODUCTION

Aging is a process of biological, psychological, and social change that occurs over time and the age of a person or elderly (elderly). Regulations of government in Indonesia explained that is an elderly person is someone who has reached the age of 60 (sixty) and above. Every elderly person will experience the process but the aging experienced will be different for each individual, this is influenced by several factors including hereditary factors, environment, physical and psychological conditions [1], [2].

Globally in 2025 the elderly population has been predicted to experience an increase. World Population Prospects (2017) shows that from 2015 in the world, Asia, and Indonesia began to enter the era of aging population characterized by an increase in the number of elderly population [2]. The increase in the world reached a figure of 12.3% to 14.9%, while in Asia it increased from 11.6% to 15%, and in Indonesia it increased from 8.1% to 11.1%. This increase was caused by an increase in the number of life expectancy (UHH) in the elderly [3]. The high UHH will cause elderly people at risk of experiencing health

problems, one of which is psychological and social problems experienced in the family, that is neglect.

Neglect is one of the most common acts of persecution in the family towards the elderly in meeting their needs, both physical and mental health needs. Neglecting the elderly can also be done intentionally or unintentionally [1], [14], [15]. The neglect can cause a decrease in the level of health and well-being in the elderly, neglect is divided into 3 types, namely physical neglect, economic neglect, and psychological neglect [4], [5], [6].

World Health Organization (WHO, 2017) shows that the incidence of neglect of the elderly in developing and developed countries is recorded at 0.2 - 5.5% and found 1 in 10 elderly people are neglected every month [7]. Abandonment events in the elderly conducted by family members occupy the second position of the biggest problem in the world that is equal to 45% after financial violence of 63% [2], [8]. Indonesia is one of the country that has the highest incidence of neglect of the elderly with a percentage of 68.55% [9].

One of the family supports emphasized in Islam is dutiful to parents. In according with the teachings of Islam which views the elderly with high respect and teaches to treat the elderly well, so that their existence is not considered to be a burden on the community, especially the family. Indirectly, at this time family members do not care about the ethics of dutiful to parents, so it can making the elderly are often to neglected in their family [10], [12].

In Islam, it is explained that as a human being it has an obligation to do good to Allah SWT and to fellow human beings (parents) and direction in relating in society. *Birrul walidain* (dutiful to parents) is one of the important obligations for Islam. As a Muslim, even though a child who has a family, the responsibility and obligation to serve his parents will never be lost. Based on the word of Allah SWT in QS. Al-Isra' verses 23-24, that are:

﴿وَقَضَىٰ رَبُّكَ أَلَّا تَعْبُدُوا إِلَّا إِيَّاهُ وَبِالْوَالِدَيْنِ إِحْسَانًا ۖ إِمَّا يَبُلُغَنَّ عِنْدَكَ الْكِبَرَ أَحَدُهُمَا أَوْ كِلَاهُمَا فَلَا تَقُلْ لَهُمَا آفٌ وَلَا تُنْهَرُ هُمَا وَقُلْ لَهُمَا قَوْلًا كَرِيمًا﴾

Translation: Thy Lord hath decreed that ye worship none but Him, and that ye be kind to parents. Whether one or both of them attain old age in thy life, say not to them a word of contempt, nor repel them, but address them in terms of honour. (QS. Al-Isra' : 23).

﴿ وَالْخُفْيُ لَهُمَا جَنَاحَ الذَّلِيلِ مِنَ الرَّحْمَةِ وَقُلْ رَبِّ ارْحَمْهُمَا كَمَا رَبَّيْتَنِي صَغِيرًا ﴾

Translation: And, out of kindness, lower to them the wing of humility, and say: "My Lord! bestow on them thy Mercy even as they cherished me in childhood." (QS. Al-Isra' : 24).

The purpose of this study is to identify the neglect of the elderly by the family in an Islamic perspective in Kalirandu village. The benefit of this study is expected to contribute and become a reference for health services, especially community nursing services in providing health education about family health duties and family support for the elderly in preventing neglect of the elderly in the family.

II. METHODOLOGY

This study using a qualitative research and the phenomenology approach. Participants in this study are 7 families that living with the elderly in Kalirandu, Bangunjiwo, Kasihan, Bantul, Yogyakarta. The method used in selecting participants is purposive sampling. This study using interviews with semi structure techniques or in-depth interviews for 45-60 minutes for each participant and unstructured observation.

III. FINDINGS

The Characteristics of Participants

Characteristics	Quantity	Percentage
Gender		
1.) Male	3	42,85%
2.) Female	4	57,15%
Age		
1.) 25 – 35 years old	3	42,86%
2.) 36 – 45 years old	2	28,57%
3.) 46 – 55 years old	2	28,57%
Last Education		
1.) Senior High School	7	100%
Job		
1.) Housewife	4	57,15%
2.) Enterpriser	2	28,57%
3.) Worker	1	14,28%

A. Findings of Interview

“Being a child should be able to take care of parents, if we were treated first now we are caring for, starting from eating, washing clothes, we give medicine if parents are sick, we also have to keep the manners if we chat with parents, no talking harshly to parents, not fighting, not lying, and most of all it's a prayer for parents. if what is about the obligation of the child, as far as I am, is in the Al Isra' which explains not allowed to say "ah" to the parents.”

(P1: Daughter, 38 years old)

“Islam requires a child to pray for parents, caring, respect, and the last is dutiful, we must be able to maintain good manners to parents, for example, do not yell, say that the soft one does not need to be rude, because we know the parent is already it's hard to enlarge us until now, willing to do anything for his child, where might we as children have to bear all the sacrifices that have been given, now is the time for us to reciprocate to our parents, we who must care as we have been cared for as a child.”

(P2: Son, 47 years old)

“That I know there is Al Isra', the surah explained that we are the child, we cannot say "ah", we must obey and the main thing is the obligation of the child to pray for the parents, because that very noble practice is the prayer for parents, back again Ridho Allah is Ridho the parents, the wrath of Allah is the wrath of the parents.”

(P3: Daughter, 34 years old)

“Islam is a very noble religion that teaches manners to parents, because we know that the most important practice is devotion to parents, besides that we as children must obey parents' orders, help parents work at home according to our abilities, if soft talk, no need to use high notes, if we can't do it better talk good to reject it, the most important thing is after prayer don't let pray for parents.”

(P4: Son, 34 years old)

“The most important thing is praying for parents, from Islam also has explained that a child must pray for parents whenever it is, because it is obligatory for the child, Ridho Allah is in the hands of parents because Ridho Allah is the parent too, Al Isra explained that a child must care, respect, and others, no one teaches us to leave parents.”

(P5: Son, 40 years old)

“From the Islamic perspective, of course it a lot. We also know that is caring to parents has become an obligation of a child. The child must be reciprocated, which we were loved to be cared for, but now is the time our parents we care for sincerely, after all the obligation of the child is not just caring for the parents, especially the one praying for parents, I often hear that too children always pray for their parents so God will raise the second degree of parents in heaven.”

(P6: Daughter, 35 years old)

“Al Isra which means it is forbidden to say "ah" to parents, in the surah it is explained that if we become children, we must worship our parents, we should not yell at parents, not speak harshly, and the most important thing is to pray for parents because it is obligatory. the child is also responsible for the livelihood of the parents, especially the ones who can't work mean that there is no income, we as children are responsible for providing, we must believe that what is done in the world will certainly be the provision we will get in the hereafter.”

(P7: Daughter, 47 years old)

B. Findings of Observation

It seen that the elderly is only in the house and are not permitted to participate in social activities in the environment, it is influenced by the elderly who have a history of gout.

(P1: Daughter, 38 years old)

It seen that the elderly is in the living room, not allowed by their children to leave the house because the atmosphere around the house is a lot of dust from the knife production by their children, so their children and daughter-in-law are busy working and leaving their mothers alone.

(P2: Son, 47 years old)

(P3: Daughter, 34 years old)

It seen that the elderly is only at home, because their children are worried about the condition of their father who will quickly get tired when participating in social activities in the neighborhood.

It seen that the elderly didn't take part in social activities, because the elderly had a history of gout, so their children forbade them to participate it. It was also influenced by the medical costs that were a main problem in the family.

(P4: Son, 34 years old)

It seen that the elderly is only at home, because their children assume that if they take part in activities in the community it will be troublesome for others, this is influenced by those who care for their parents only while their other siblings are not in Yogyakarta.

(P5: Son, 40 years old)

It seen that the elderly is not allowed to participate in social activities, because the daughter is worried about the condition of her mother and the location of the house is so far away from the location of the activity, so she decides not to allow her mother to join it.

(P6: Daughter, 35 years old)

It seen that the elderly didn't take part in in activities in the community, because the daughter not interested in the activity, so the daughter decided not to join it.

(P7: Daughter, 47 years old)

IV. DISCUSSION

The results of the study showed that all participants knew about how to care for parents who were elderly in an Islamic perspective. Children and parents have the closest and inseparable relationship with the environment, so that both have authorization and obligations that must be fulfilled [13]. The authorizations and obligations that must be fulfilled are providing livelihood and praying for parents.

The child's obligation is to help parents fulfill their needs, in other words children are obliged to provide for their parents. The obligation to provide is one form of filial piety to both parents as instructed by Allah SWT, therefore the obligation to provide for parents is one of the things that cannot be ignored [11], [13]. This obligation is in accordance with the word of Allah SWT in QS. Al-Baqarah verse 215, that is :

﴿يَسْأَلُونَكَ مَاذَا يُنْفِقُونَ قُلْ مَا أَنْفَقْتُمْ مِنْ خَيْرٍ فَلِلَّوَالِدِينَ وَالْأَقْرَبِينَ
وَالْيَتَامَى وَالْمَسَاكِينِ وَابْنِ السَّبِيلِ وَمَا تَفْعَلُوا مِنْ خَيْرٍ فَإِنَّ اللَّهَ بِهِ
عَلِيمٌ

Translation: They ask you, (O Muhammad), what they should spend. Say, "Whatever you spend of good is (to be) for parents and relatives and orphans and the needy and the traveler. And whatever you do of good - indeed, Allah is Knowing of it.

The verse explains that someone who wants to spend his wealth, should be spent first on his parents, this is because parents have educated their children from childhood so that adults, therefore Allah SWT instructs a child to return the favor by caring for and providing a living, especially for parents who has been elderly. For a son, providing for his family is an obligation, especially if the child is married, because a man is a leader of his family, therefore as a leader he must be a good example for his family, able to protect and fulfill everything need (provide for) his family [11]. In accordance with QS. An-Nisaa' verse 34, that is:

﴿الرِّجَالُ قَوَّامُونَ عَلَى النِّسَاءِ بِمَا فَضَّلَ اللَّهُ بَعْضَهُمْ عَلَى بَعْضٍ
وَمَا أَنْفَقُوا مِنْ أَمْوَالِهِمْ فَاصْطَلِحْ فَبِتَتْ حِفْظٌ لِلْغَيْبِ بِمَا حَفِظَ اللَّهُ
وَالَّتِي تَخَافُونَ نُشُوزَ هُنَّ فَعِظُوهُنَّ وَأَهْجُرُوهُنَّ فِي الْمَضَاجِعِ
وَأَصْرِبُوهُنَّ فَإِنْ أَطَعْتَكُمْ فَلَا تَبْغُوا عَلَيْهِنَّ سَبِيلًا إِنَّ اللَّهَ كَانَ عَلِيمًا
كَبِيرًا

Translation: Men are in charge of women, because Allah hath made the one of them to excel the other, and because they spend of their property (for the support of women). So good women are the obedient, guarding in secret that which Allah hath guarded. As for those from whom ye fear rebellion, admonish them and banish them to beds apart, and scourge them. Then if they obey you, seek not a way against them. Allah is ever High, Exalted, Great.

Praying for parents is an obligation of a child who is obligatory and has been ordered by Allah SWT. A child's prayer to a sincere parent will raise the degree of parents to heaven. In essence, pray for salvation to both parents not only after both died, but when both are still alive and in near and far [10], [11], [13]. The obligation to pray for parents is stated in QS. Al-Isra' verse 24, that is:

﴿وَخُضِّعْ لَهَا جَنَاحَ الذَّلِيلِ مِنَ الرَّحْمَةِ وَقُلْ رَبِّ ارْحَمْهُمَا كَمَا رَبَّيْتَنِي
صَغِيرًا

Translation: And, out of kindness, lower to them the wing of humility, and say: "My Lord! bestow on them thy Mercy even as they cherished me in childhood."

The verse explains that as sons and daughters have an obligation to always pray for both parents as God has commanded. Praying for parents is a child's obligation that always flows during his life. Child's prayer to parents will get glory in His hereafter, this is because praying for both is one form of expressing gratitude and devotion for a child to parents [10], [13].

The difference with the elderly who do not have support from the family to participate in activities in the community is that the elderly experience isolation of social. Moreover, this happens continuously will cause the elderly to become depressed. This problem is inversely proportional to Islam which teaches that fellow human beings must establish a relationship, according to Rasulullah Shallallahu'alaihi Wasallam he say his people must to connect the relationship, in his the words:

من كان يؤمن بالله واليوم الآخر فليكرم ضيفه، ومن كان يؤمن بالله واليوم الآخر فليقل خيراً أو ليصمت

Translation: Whoever believes in Allah and the doomsday, then glorify the guests. Whoever believes in Allah and the doomsday, connect the relationship. Whoever believes in Allah and the doomsday, then say good or silent.

The hadhiths explains that as a Moeslim it is important for someone to establish the relationship. Connecting relationship is one of the noble deeds and obligations in religion. Many verses of the Qur'an and hadiths that cause us to connect the relationship and explain its various benefits. Based on the hadiths, as for the benefits of connecting the relationship is given a lot of sustenance, extended his age, and also it is one of the reasons for the entry of someone into heaven [16].

ACKNOWLEDGMENT

This research was supported by our colleagues from School of Nursing, Universitas Muhammadiyah Yogyakarta who provided insight and expertise that greatly assisted of this paper.

REFERENCES

- [1] Miller, C. A. (2012). *Nursing for Wellness in Older Adults* (Sixth). China: Wolters Kluwer Health.
- [2] Burnes, D., Pillemer, K., Caccamise, P. L., Mason, A., Henderson, C. R., Berman, J., ... Lachs, M. S. (2015). Prevalence of and Risk Factors for Elder Abuse and Neglect in the Community: A Population-Based Study. *Journal of the American Geriatrics Society*, 63(9), 1906–1912. <https://doi.org/10.1111/jgs.13601>
- [3] Kemenkes, R. (2017). *Analisis Lansia di Indonesia*. Jakarta Selatan: Pusat Data dan Informasi RI. Retrieved from <http://www.pusdatin.kemkes.go.id/article/view/18012600001/analisis-lansia-di-indonesia-2017.html>
- [4] Cooper, C., & Livingston, G. (2014). Mental Health/Psychiatric Issues in Elder Abuse and Neglect. *Clinics in Geriatric Medicine*, 30(4), 839–850. <https://doi.org/10.1016/j.cger.2014.08.011>
- [5] Anand, A. (2016). Exploring the role of socioeconomic factors in abuse and neglect of elderly population in Maharashtra, India. *Journal of Geriatric Mental Health*, 3(2), 150–157. <https://doi.org/10.4103/2348-9995.195640>
- [6] Rosen, T., Lachs, M. S., Teresi, J., Eimicke, J., Van Haitsma, K., & Pillemer, K. (2016). Staff-reported strategies for prevention and management of resident-to-resident elder mistreatment in long-term care facilities. *Journal of Elder Abuse & Neglect*, 28(1), 1–13. <https://doi.org/10.1080/08946566.2015.1029659>
- [7] WHO. (2017). *Global Survey on Geriatrics in the Medical Curriculum*. English.
- [8] Peterson, J. C., Burnes, D. P. R., Caccamise, P. L., Mason, A., Henderson, C. R., Wells, M. T., ... Lachs, M. S. (2014). Financial Exploitation of Older Adults: A Population-Based Prevalence Study. *Journal of General Internal Medicine*, 29(12), 1615–1623. <https://doi.org/10.1007/s11606-014-2946-2>
- [9] Saputro, S., Rustama, A., Sudarsana, Kusnandar, Istiqomah, N., Khoiriyah, S., ... Karyanta, N. A. (2015). Analisis Kebijakan Pemberdayaan dan Perlindungan Sosial Lanjut Usia. *Deputi Bidang Koordinasi Penanggulangan Kemiskinan Dan Perlindungan Sosial*.
- [10] Anggraini, L. D. (2017). Pandangan Islam Terhadap Lansia serta Berbagai Kesehatan Lansia. *Universitas Muhammadiyah Yogyakarta*.
- [11] I'annah, N. (2017). Konsep Relasi Orang Tua dan Anak dalam Islam. *Buletin Psikologi*, 25(2), 10. <https://doi.org/10.22146/buletin.psikologi.27302>
- [12] Acierno, R., Hernandez, M. A., Amstadter, A. B., Resnick, H. S., Steve, K., Muzzy, W., & Kilpatrick, D. G. (2013). Prevalence and Correlates of Emotional, Physical, Sexual, and Financial Abuse and Potential Neglect in the United States: The National Elder Mistreatment Study. *American Journal of Public Health*, 100(2), 292–297. <https://doi.org/10.2105/AJPH.2009.163089>
- [13] Bahri, S. (2016). Nafkah Anak Kepada Orang Tua dalam Pandangan Hukum Islam (Studi Kajian Hadits Tamlik), 11, 15.
- [14] Amstadter, A. B., Cisler, J. M., McCauley, J. L., Hernandez, M. A., Muzzy, W., & Acierno, R. (2015). Do Incident and Perpetrator Characteristics of Elder Mistreatment Differ by Gender of the Victim? Results from the National Elder Mistreatment Study. *Journal of Elder Abuse & Neglect*, 23(1), 43–57. <https://doi.org/10.1080/08946566.2011.534707>
- [15] del Carmen, T., & LoFaso, V. M. (2014). Elder Neglect. *Clinics in Geriatric Medicine*, 30(4), 769–777. <https://doi.org/10.1016/j.cger.2014.08.006>
- [16] Abdurrohman, Usman, & Aenul Latifah, N. (2014). *Akidah Akhlak*. Jakarta: Kementerian Agama RI. Retrieved from http://pendis.kemenag.go.id/file/dokumen/bukupaiarab/buku_akidah_akhlak_MA_10_guru.pdf

The Compliance of Hand Hygiene for Professional Nurses Student

Suratmi

Faculty of Health Science, Nursing
Department

Universitas Muhammadiyah Lamongan
Lamongan, East Java, Indonesia
suratmistikesmuhla@gmail.com

Sri Hananto Ponco

Faculty of Health Science, Nursing
Department

Universitas Muhammadiyah Lamongan
Lamongan, East Java, Indonesia
hanantoponco@yahoo.com

Nurul Hikmatul Qowi

Faculty of Health Science, Nursing
Department

Universitas Muhammadiyah Lamongan
Lamongan, East Java, Indonesia
nurulqowi@gmail.com

Abstract— Background: *The first-line infection control strategy in hospitals is the application of five-moment for hand hygiene. This study aims to explain the compliance of five moment for hand washing for professional practice nurses student. Method: This research was a quantitative descriptive study. The sampling method used total sampling with 183respondents. The compliance of five moment hand hygiene was measured using an observation sheet. Data were analyzed using frequency distribution. Results: The students who washed their hand before patient contact were 31%, and 69% student weren't. The student's compliance of hand hygiene on 2nd moment, before doing aseptic procedure, were 74%, 26% weren't obedient. The student's hand hygiene behaviour in 3rd moment, after body fluid exposure, were 98%. Students who washed their hand after patient contact were 100%, and 0% weren't. The student's hand hygiene behaviour in 5rd moment, after contact with patient surroundings were 46%. Conclusion: The student compliance for hand hygiene is obtained at 4th moment and non-compliance is obtained at the 1st moment. The efforts to increase student compliance in five moment of hand washing need to be improved to support patient safety goals in hospital.*

Keywords—*hand hygiene, five moments, nurses students*

INTRODUCTION

Every year, hundreds of millions patients are infected with Healthcare Associated Infection (HAI) worldwide [1]. Healthcare Associated Infection is infections occurring in patients during the treatment process in hospitals or other service facilities that do not exist when entering [1]. Prevention of HAI is the responsibility of all elements in the hospital. Everyone can transfer the infection to patients, especially who come in direct contact with patients. Health workers who provide care to patients are very potential in transmitting infections, including health students who are undergoing clinical practice in hospitals. Hand washing is the first step to prevent HAI [2], [3], [4]. Health and non-health care providers, families of patients, students, and everyone in the hospital must be able to wash their hands well in an effort to improve handwashing behavior. Some students ignore hand hygiene in high-risk situations, failing to protect patients and themselves against HAI [4]. The role of educational institutions in reducing HAI is the effort to increase compliance with handwashing for nursing students before they enter practice learning [5]. The handwashing skill had been included in the nursing curriculum, but nursing students are still considering why not washing hands [6]. The compliance of washing hands of students in five moments is unknown.

HAI that occurred in the world 23% came from contact with the environment, 12% from compliance with hand

washing in public agencies and 44% in private agencies [1]. In Ireland, the prevalence of infections associated with health care in acute care facilities was 5.2% [7]. Health workers who had the most role in transmission of HAI was nurses because they accompanied patients for 24 hours [8]. Based on Süzük et al. (2015) [9] stated that ICU nurses adherence to handwashing was 66.85% of 591 handwashing opportunities, inpatient nurse hand hygiene compliance was low (35%) [10]. In addition to nursing staff, students who practice clinics in hospitals were also involved in HAI transmission in hospitals. The compliance of nursing students in doing hand washing was 83.5% [4].

Hand hygiene compliance related to the factors that influence it. WHO (2009) [6] states that high workloads, lack of time for handwashing, location of handwashing materials that are difficult to access, presence of skin irritation, gender, perception, and profession of health workers affect the good and bad behavior of hand washing. Foote and El-Masri (2016) [11] mentions a number of things that stimulate handwashing behavior in students such as gender, knowledge of HAI, utilization and techniques of using handrubs, and exposure to situations that require hand washing. Reprimand for not complying with handwashing guidelines, individual motivation, having a handwashing, busy, forgetful mentor and fear of skin damage due to handrub can predict compliance with handwashing in nursing students [11].

Nursing students perform various tasks and nursing procedures for patients during clinical practice, so that they always make direct contact with patients [4]. The frequency of nursing students' hand washing that is less can be a bacterial transmission in the hospital. As a result, the number of HAI can increase, both for patients, families of patients, and nursing students themselves. Identifying the behavior of nurses handwashing is the first step to improving and maintaining their overall obedience [4], and nursing education has an important role in shaping and ensuring the competency of hand washing behavior before they conduct clinical practice [5]. Therefore, we want to observe compliance with hand washing in nursing students who undergo clinical practice. Hand hygiene observed at five moments, including before patient contact and an aseptic task, after body fluid exposure, patient contact, and after contact with patient surroundings.

METHODS

This research was a quantitative descriptive study that explain about the compliance of nursing students in five moment hand washing. The study was conducted with

observations on students in February-March 2019 in several hospitals which became the practice sites of professional nursing students. Observation was carried out at one time as long as students practiced according to the opportunity to wash their hands at five moments, there was two moments before, and three moments after. The first moment and second moment were before patient contact and an aseptic task. The three moment after include after body fluid exposure, after patient contact, and after contact with patient surroundings. The researcher conducted direct observations based on the observation sheet prepared by the research team. Compliance with hand washing observed is hand washing using soap and using handrub. The sample was observed by observing all professional student students with 183 students. The sampling method uses the total sampling method. All data collected was then recapitulated and analyzed using frequency distribution.

RESULTS

Observation of hand washing compliance was carried out on 183 professional nursing students. The researcher made direct observations of students regarding five-moment hand washing' compliance. Table 1. Explain the results of direct observation of student compliance in doing hand washing. Based on table 1, nursing students were very obedient to do handwashing at the 4th moment, that was after patient contact (100%) and 3rd moment, after patient's fluids exposure (98%). Washing the hands before patient contacs (31%) contributed the biggest contribution to non-compliance followed by 5th moment after touching the patient's surroundings (46%). Student compliance in washing hands before aseptic prosedures was 74%.

DISCUSSIONS

Hand hygiene is a general term that refers to various hand cleansing actions in different situations, including the act of rubbing hands with a handrub [7]. Sax (2009) [12] defines hand washing as an activity of rubbing hands with alcohol with a handrub or washing hands with soap and running water. Compliance with hand washing can be done at five moments of hand washing. The highest compliance of hand washing based on this reseach was the 4th moment. This result was supported by previous research which explained that the highest adherence of students in washing hands was after touching the patient [4]. The second compliance of nursing student's hand washing was after body fluid exposure. Sundal (2017) [4] and Kingston (2018) [7] was found results similar to this study.

During clinical practice, nursing students carry out various tasks and nursing procedures for patients, so that they always make direct contact with patients [4]. Nursing students will wash their hands in situations that they think need hand washing [11]. Allegranzi and Pittet (2009) [13] explain that the desire to wash hands is very high when their hands look dirty as after exposure to patient fluids. Motivation of students not to be infected by microorganisms from patients either from direct contact or direct fluids of patients can also be a reason to do hand washing. Mentors in hospital can encourage students to adhere to established guidelines, so students can contribute to increasing compliance with hand hygiene and patient safety, reducing HAI [4]. Facilities and resources that support the implementation of hand washing both in educational institutions, as well as in clinical services are provided to support the learning process [7], [2].

STUDENT COMPLIANCE IN THE IMPLEMENTATION OF FIVE MOMENTS FOR HAND WASHING

Compliance of Hand Hygiene	Yes	No
before patient contact	57 (31%)	126 (69%)
before an aseptic task	135 (74%)	48 (26%)
after body fluid exposure	180 (98%)	3 (2%)
after patient contact	183 (100%)	0 (0%)
after contact with patient surroundings	84 (46%)	99 (54%)

The observation results showed that nursing students rarely wash their hands after contact with the patient's environment. Kingston (2018) [7] said that non-compliance of hand washing was after touching the patient's environment. The patient's environment is also very influential in the transmission of infection to other patients. Bed dividers, lockers, patient tables, and door handles are the environment around patients who are often touched by nurses that contain norovirus, clostridium difficile and meticillin-resistant staphylococcus aureus [14]. Nurse student's hand can transfer microorganism from petient's environment to others.

Nursing students also rarely wash their hands and before taking aseptic prosedures. According to Fuller C et al (2011) [15], most health workers believe that hand washing does not need to be done before taking aseptic prosedures because they will wear gloves that will prevent transmission of microorganisms during aseptic procedures. Using gloves avoid contact with blood, infectious material, mucus buildup, and skin that is not intact when taking action to patients [16]. Fuller C et al (2011) [15] added that basically the use of gloves does not prevent cross infection. The use of gloves can reduce the chance of microorganisms being moved, but cannot replace hand washing [2]. Increasing handhygiene behavior is done by Integrating of hand washing learning based on evidence based practice academic and clinical environment [17] and monitoring the compliance of handwashing regularly between students and health workers [18], including timely feedback [4].

CONCLUSIONS

Hand washing is the most important step to prevent infection related to health services, and students are one of the components who must be involved in preventing infection in the hospital. Based on this research, the student compliance for hand hygiene is obtained at 4th moment, after patient contact, and non-compliance is obtained at the 1st moment, before patient contact. This result show that nursing students behavior is not obedient to hand washing. The description of compliance will be the basis of the intervention that will be carried out by the educational institution in improving the handwashing behavior of students in the hospital. The efforts to increase student compliance in five moment for hand washing need to be improved to increase patient safety in hospital.

REFERENCES

[1] Tyagi, M., Hanson, C., Schellenberg, J., Chamarty, S., & Singh, S. (2018). Hand hygiene in hospitals : an observational study in hospitals from two southern states of India. *BMC Public Health*, 18, 1–9. <https://doi.org/10.1186/s12889-018-6219-6>

- [2] Öncü, E., Köksoy, S., & Ebru, Y. (2018). Nurse Education Today An evaluation of the effectiveness of nursing students' hand hygiene compliance: A cross-sectional study. *Nurse Education Today*, 65(June 2017), 218–224. <https://doi.org/10.1016/j.nedt.2018.02.027>
- [3] Ribeiro, S., Rn, F., Marra, A. R., Augusta, R., Figueiredo, D. O., Fernando, O., ... Edmond, M. B. (2013). American Journal of Infection Control The effect of contact precautions on hand hygiene compliance. *American Journal of Infection Control*, 41(6), 558–559. <https://doi.org/10.1016/j.ajic.2012.08.010>
- [4] Sundal, J. S. (2017). The hand hygiene compliance of student nurses during clinical placements, 0–1. <https://doi.org/10.1111/ijlh.12426>
- [5] Labrague, L. J., McEnroe-Petite, D. ., Van de Mortel, T., & Nasirudeen, A. M. . (2017). A systematic review on hand hygiene knowledge and compliance in student nurses. *International Council of Nurses*, 1–13. <https://doi.org/10.1111/inr.12410>
- [6] WHO. (2009). *Guidelines for hand hygiene in health care*. Geneva, Switzerland: WHO.
- [7] Kingston, L. M. (2018). A comparative study of hand hygiene and alcohol-based hand rub use among Irish nursing and medical students. *Nurse Education Today*. <https://doi.org/10.1016/j.nedt.2018.01.022>
- [8] Tjiejjen. (2005). *Panduan Pencegahan Infeksi untuk fasilitas pelayanan kesehatan dengan sumber daya terbatas*. Jakarta: YBP Sarwono Prawiroharjo.
- [9] Süzük, S., Edis, Ç., Çalık, A., & Akdoğan, S. (2015). The Compliance Rates of Hand Hygiene in Intensive Care Unit and Surgical Services at a State Hospital in Turkey Türkiye ' de Bir Devlet Hastanesi Yoğun Bakım Ünitesi ve Cerrahi Servislerinde El Hijyeni Uyum Oranları. *J Turk Soc Intens Care*, 13(1), 107–111. <https://doi.org/10.4274/tybdd.77699>
- [10] Ernawati, E., Wiyanto, S. (2014). Application of Nurse ' s Hand Hygiene in Hospital ' s Inpatient units. *Jurnal Kedokteran Brawijaya*, 28(1), 89–94.
- [11] Foote, A., & El-Masri, M. (2016). Self-perceived hand hygiene practices among undergraduate nursing students. *Journal of Research in Nursing*, 21(1), 8–19.
- [12] Sax. (2009). The World Health Organization hand hygiene observation method. *Am J Infect Control*, 27, 827–34.
- [13] Allegranzi and Pittet. (2009). The role of hand hygiene in healthcare-associated infection prevention. *J Hosp Infect* 2009;73:305e315
- [14] Dancer SJ. The role of environmental cleaning in the control of hospital acquired infection. *J Hosp Infect* 2009;73:378e385
- [15] Fuller, C., Savage, J., Besser, S., Hayward, A., Cookson, B., Cooper, B., et al. (2011) "The dirty hand in the latex glove": a study of hand hygiene compliance when gloves are worn. *Infect Control Hosp Epidemiol* 2011;32:1194-9.
- [16] Malliarou, M., Sarafis, P., Zyga, S., Constantinidis, T. (2013). The importance of nurses hand hygiene . *International Journal of Caring Sciences September-December 2013 Vol 6 Issue 3*
- [17] Korhonen, A., Vuori, A., Lukkari, A., Laitinen, A., & Perälä, M. (2019). Increasing nursing students' knowledge of evidence-based hand-hygiene: A quasi-experimental study. *Nurse Education in Practice*. <https://doi.org/10.1016/j.nepr.2018.12.009>
- [18] Zhao, Q., Yang, M. M., Huang, Y., & Chen, W. (2018). How to make hand hygiene interventions more attractive to nurses: A discrete choice experiment. *PLOS ONE*, 1–11. <https://doi.org/10.1371/journal.pone.0202014> August

The Effect of Lavender Aromaterapy on Decreasing the Levels of Anxiety in Undergoing Osce for The Second Year Students of Nursing Bachelor of Universitas Muhammadiyah Cirebon 2019

1st Rully Annisa*

Lecturer in Nursing Bachelor Study
Faculty of Health Sciences,
Universitas Muhammadiyah Cirebon
rully@umc.ac.id

2nd Ima Nurhikmah

Student of Nursing Bachelor Study
Faculty of Health Sciences,
Universitas Muhammadiyah Cirebon

Abstract-- OSCE is a skills performance) based test observed when performing various clinical skills that are examined objectively and structurally. OSCE has a weakness which can arouse students' anxiety. The causes of anxiety during OSCE are partly due to pressure from the environment, family and students who will take the exam, failure past experience of the exam, and exaggerate fear on the results thus students' anxiety occurs. This study aims to analyze the effect of Lavender Aromatherapy on the Decrease of Anxiety Level in Undergoing OSCE for second year students of S1 Nursing, Faculty of Health Sciences, Universitas Muhammadiyah Cirebon. This research used Quasi-experimental design of pretest-posttest one group Design approach, with a total sampling technique. The number of samples was 36 respondents. Data collection was done using questionnaire and standard TAI-G scale checklist tool. The analysis technique used Paired T-test. Paired t Test results show the value of $p = 0.014$ ($p < 0.05$) with the value of t count = 2.583 (t count > t table ($df 35 = 1.6896$) with a positive value (+). Paired t Test test results concluded that the provision of lavender aromatherapy was effective in reducing the level of anxiety in undergoing OSCE for second-year students of Bachelor Nursing.

Keywords: Lavender Aromatherapy, Anxiety Level, OSCE , Nursing Students

I. INTRODUCTION

Nursing academic education is an educational process that must be taken at universities in Indonesia that provides theories and concepts understanding. The method of nursing education process consists of theoretical and clinical education. For the success of students' clinical practice readiness, the method that can be applied to assess is OSCE (*Objective Structured Clinical Examination*).

OSCE is a format test to determine students' competency skills. OSCE is a skills (performance) – based test observed when carrying out various clinical skills that are tested in an objective and structured manner. If the students are not able to perform OSCE actions well, the consequence that must be accepted is to retake the exam, therefore many students feel anxious before OSCE [5].

Anxiety management that is usually done is non-pharmacological anxiety management, such as distraction techniques, relaxation techniques and skin simulation

techniques. One non-pharmacological therapy that can be done is relaxation therapy with aromatherapy that can provide sensations to calm down the students and the brain, as well as the stress [1].

Lavender aromatherapy is a therapy that uses essential oils which are considered to help in reducing even overcoming psychological disorders and discomforts such as anxiety, stress, depression, and other negative factors. It was found that there was an effect of stress levels between before and after the intervention of lavender aromatherapy to students. Lavender aromatherapy can affect the stress level of students in undergoing OSCE [5].

Based on preliminary studies conducted by researchers on second year students of Nursing Study Program in Faculty of Health Sciences on January 21, 2019 at the Universitas Muhammadiyah Cirebon as many as 45 students of 2017 class, the results of interviews from 9 students stated that OSCE really made them worried; 6 students experienced severe anxiety level because they experienced dizziness, insomnia, confusion, feelings of helplessness; and 3 students experienced moderate levels of anxiety with symptoms of muscles becoming tense, the increase of heart rate and breathing, and the decrease of concentration.

II. METHOD

This study used a Quasi-Experimental Design. Researchers took pretest-posttest one group Design. The sample technique of this study used total sampling. The sample of this study were the second year students of Nursing Bachelor of Health Sciences Faculty in Universitas Muhammadiyah Cirebon with a total sample of 36 students, because 9 students had been used as the sample in preliminary studies. This study used the *Anxiety Inventory-G (TAI-G)* test instrument, TAI-G consisted of 21 statement items; 7 items of statements that measure *worry*, 7 items of statements that value *emotionality*, 4 items of statements that measure *interference*, and 3 items of statements that measure *lack of confidence*. Statement items used a 4-point

Likert scale. Researcher did not test the validity and reliability as the instrument had been tested to PSIK professional students from Gajah Mada University and done by Santi Dinda Putri Utami to students PSIK Muhammadiyah University of Yogyakarta to diniai validity and reliability. This instrument had a *Cronbach's Alpha* value of 0.827.

III. RESULTS

Table 1 shows that the level of anxiety in the experimental group decreased after the treatment. Students who experienced high levels of anxiety were 7 students (28%), then after being given lavender aromatherapy it showed a decrease in the students' anxiety level in undergoing OSCE.

Comparative Test of Pre-post Anxiety Level on Lavender Aromatherapy in the Experimental Group

	Experimental Group			The mean (SD)
	High	Fair	Low	
Pretest	7 (28%)	17 (68%)	1 (4%)	58.76 ± 6.863
Posttest	1 (4%)	17 (68%)	7 (28%)	51.36 ± 8.558

Table 2. describes the value of *Pre* and *Post Test* of Anxiety Level in Second year Students of PSIK Fikes UMC from experimental Group in Undergoing OSCE. Table 2 shows that the intervention group has a value of *mean difference* in the level of anxiety is 3.917 in positive score, which means there is a tendency impairment of anxiety levels after treatment with the average increase was 3.917 . Based on the value of $p = 0.014$, it can be concluded that there are significant differences in the *pre* and *post* values of lavender aromatherapy in the intervention group ($p < 0.05$) with t count = 2.583 (t count > t table (df 35 = 1.6896) with a positive value (+) indicates that the level of anxiety before the intervention of lavender aromatherapy is higher than the level of anxiety after the intervention of lavender aromatherapy, so it can be concluded that lavender aromatherapy is effective in reducing anxiety levels

Table 3. Comparative Tests of Pre-post Anxiety Levels of Lavender Aromatherapy Administration in the Experimental Group

Variable	Intervention Group		Mean Difference	t	Value of p	95% Confidence Interval of the Difference	
	Pre	Post				Upper	Lower
	Mean (SD)	Mean (SD)					
Anxiety Level	57.14 ± 8,142	53.22 ± 9.781	3,917	2,583	0.014	6,995	.839

DISCUSSION

Theoretically anxiety can be overcome by using pharmacological and non-pharmacological therapies. In this study researchers used lavender aromatherapy as one of aromatherapy that can be used to reduce anxiety levels. As lavender aromatherapy mostly contains *linalool* which can provide a relaxing effect. Aromatherapy is a method to cure diseases using fragrances made from plants that smell nice. Lavender aromatherapy is one of the aromatherapy oils that are widely used today, both by inhaled or massage techniques. Lavender contains *linalool* which has a calming / relaxing effect. Lavender also helps relieve insomnia, anxiety and depression [4].

It can be concluded that lavender aromatherapy can be felt directly by inhalation through deep breathing techniques accompanied by inhalation which can have an effect of calming the anxious feelings of students who are conducting OSCE exams.

This is in accordance with research conducted by Sarah in which concluded that the administration of lavender inhalation aromatherapy was effective in reducing student anxiety in undergoing OSCE [2]. Lavender is chosen as an alternative in the use of aromatherapy because it is one of the safest oils and has a strong antiseptic, anti-depressant with a sweet-smelling, floral, very herbal aroma so that it is widely used as the most popular aromatherapy that has many benefits.

This decreased score occurs due to the administration of lavender aromatherapy which is believed to be beneficial in calming and balancing emotions, improving memory and relieving tension and sleep difficulty. Lavender aromatherapy is one of the famous aromatherapy which has sedative, hypnotic, and anti-neurodepressive effects in humans because lavender oil provides a sense of calm so that it can be used as an alternative to reduce anxiety.

The main content in lavender oil is *linalool acetate oil* which is able to relax the working system of nerves and tense muscles, so that it can be used in stress management [1]. There are several things that occur after the administration of lavender aromatherapy techniques like effective as a sedative that functions to calm the central nervous system that can help overcome insomnia, especially by stress, anxiety, worry, tension, and depression [3].

Based on the data above, researchers believe that the decrease of anxiety levels that occur due to the administration of lavender aromatherapy. The positive impact of aromatherapy on reducing anxiety is due to lavender aromatherapy given directly (inhalation). The mechanism through smell is faster than other methods, because through inhalation it has direct contact with parts of the brain that stimulate the formation of effects caused by lavender aromatherapy.

CONCLUSIONS AND SUGGESTIONS

Paired t-test analysis results obtained p value = 0.014, thus it can be concluded that there are significant differences in the *pre* and *post value* of lavender aromatherapy intervention groups (where $p < 0.05$) with t count = 2.583 (t count $>$ t table (t df 35 = 1.6896)) with a positive value (+) indicates the value of anxiety level before the administration of lavender aromatherapy higher than the level of anxiety after the administration of lavender aromatherapy, so that it can be concluded lavender aromatherapy was effective in reducing anxiety levels. The results of this study are expected to be a source of information for students who will take part in the OSCE in order to better prepare before conducting OSCE, not only preparation for knowledge but also mentality in order to be able to maximize their abilities during exams.

BIBLIOGRAPHY

- Iga Prima. (2011). *Lavender aromatherapy as a Relaxation Media*. Bali: Pharmacy Section, Faculty of Medicine, Udayana University.
- Farahat, E., Rice, G., Daher, N., Heine, N., Schneider, L., & Connell, B. (2015). Objective Structured Clinical Examination. *Journal of Allied Health*, 208-214.
- McCluskey, D. (2008). *Essential practical abilities in OSCE in the field of Medicine (Riwanto, Trans)*. Jakarta: EGC.
- Mehtap, K., Sibel, K., & Mehtap, T. (2014). Effectiveness of aromatherapy in reducing test anxiety among nursing students. *Indian Journal of Traditional Knowledge*, 1 (1).
- Tricintia, Y., Ivana, T., & Agustina, D. (2017). The Effect of Lavender Aromatherapy on Stress Levels Undergoing OSCE for the 4th Semester Students of Class VIII at Stikes Suaka Insan Banjarmasin

Withdrawal Level of Cigarette Smoker on University Student

1st Resti Yulianti Sutrisno*

School of Nursing

Faculty of Medicine and Health Science,
Universitas Muhammadiyah Yogyakarta, Indonesia
restiyulianti@umy.ac.id

2nd Wisnu Tri Andono

School of Nursing

Faculty of Medicine and Health Science,
Universitas Muhammadiyah Yogyakarta, Indonesia

3rd Aoladul Muqarrobin

School of Nursing

Faculty of Medicine and Health Science,
Universitas Muhammadiyah Yogyakarta, Indonesia

4th Erfin Firmawati

School of Nursing

Faculty of Medicine and Health Science,
Universitas Muhammadiyah Yogyakarta, Indonesia

Abstract—*New smokers in Indonesia is increasing, especially in adolescence and adulthood. The number of smokers at an early age causes the consumption of cigarettes to be longer and increased so that it can increase nicotine levels in the body. The cigarette has nicotine that can make withdrawal conditions. This research aims to know the withdrawal of cigarette smoker levels on a university student. The research method used descriptive research with the cross-sectional design — the sampling technique used snowball sampling. The sample was 41 respondents. The inclusion criteria were the age of university students 20-24 years old, physical and mentally healthy, active smoker; the minimum number of cigarettes was one cigarette per day. questionnaire was used to know the withdrawal level of cigarette smokers. Data analyzed used descriptively. The results of the research showed that all respondents were male, the average age of respondents was 22 years with an age range of 20-24 years, the average smoking time was five years with duration of smoking for 3-7 years, smoking time was mostly 16 -30 minutes. Most of the cigarette smokers have a high and moderate withdrawal level; the mean withdrawal level of cigarettes was 9.70.*

Keywords— *withdrawal level, cigarette, smoker*

INTRODUCTION

Indonesia is a country with the highest prevalence of male smokers with more than fifteen years of age in the world at 76.2% (WHO, 2016). The high prevalence can be caused by younger smoking. This can be seen from result of Riset Kesehatan Dasar Republik Indonesia (2018), the increasing prevalence of smokers in children and adolescents aged 10-18 years, namely 7.2% in 2013, up to 8.8% in 2016, and 9.1% in 2018 [10]. Besides that, age rates start smoking at most in the adolescent phase and with an amount that always increases every year. The rate of starting smoking for ages 15-19 years in 2010 was 43.3% and increased to 55.4% in 2013. This increase also occurred in adolescents aged 20-24 years. In 2010, the rate of starting smoking was 14.6% and increased in 2013 to 16.6% [3].

A cigarette is a risk factor for disease which gives the biggest contribution compared to other risk factors. A smoker has a risk of 2 to 4 times as much for coronary heart disease and has a higher risk of developing lung cancer and other non-communicable disease [11]. NCDs are estimated to account for 71% of total deaths for Indonesia [17]. A 2015 National Research and Development Agency study showed that Indonesia accounts for more than 230,000 deaths due to consumption of tobacco products annually. Globocan 2018 states, of the total cancer deaths in Indonesia, lung cancer ranks first as the cause of death which is 12.6%. Based on data from Persahabatan Hospital 87% of lung cancer cases are related to smoking [11]

Cigarettes contain several substances that are harmful to the body. The nicotine levels contained in tobacco cigarettes are 1.54-260 mg per cigarette [6]. In adults, cigarettes can cause short-term and long-term effects. The impact of short-term smoking can cause respiratory problems as well as respiratory problems such as nicotine dependence. Cigarette smoking harms almost every organ of the body, causing many diseases. Smoking causes around 90% of all deaths from lung cancer. More women die from lung cancer each year. Smoking causes around 80% of all deaths from chronic obstructive pulmonary disease (COPD). Smokers have a greater risk for diseases that affect the heart and blood vessels (cardiovascular disease). Smoking causes coronary heart disease and stroke. Smoking can cause lung disease by destroy airways and small air sacs (alveoli) in lungs. Lung diseases caused by smoking include COPD, chronic bronchitis and emphysema. Cigarette smoking causes most cases of lung cancer. Smoking can cause cancer almost anywhere in body, Bladder, Blood (acute myeloid leukemia), Cervical, Colon and Rectal (colorectal), Esophagus, Kidney and ureter, Larynx, Liver, Oropharynx (including throats, throat) tongue, soft palate, and tonsils), Pancreas, Stomach, Trachea, bronchus and lungs. Smoking also increases the risk of death from cancer and other diseases in cancer patients and survivors [5]

The results of a preliminary study on three users of tobacco cigarettes obtained results, tobacco cigarette smokers using tobacco cigarettes approximately five times a day and for 15 minutes once smoking, they also said that they never woke up at night to smoke. They said it was very difficult to stop smoking, before using or recognizing tobacco cigarettes they were initially just curious about the taste and trial and error. Within one week they said they had a strong desire to smoke, and when they were banned from smoking they also found it difficult to resist the urge to smoke, and when they did not smoke it felt uncomfortable, but if they did not they did not feel anxious.

METHODOLOGY

The design of this research is descriptive research and uses cross-sectional techniques. Sampling in this study used a snowball sampling technique, and the study sample was 41 respondents. The inclusion criteria were the age of university students 20-24 years old, physical and mentally healthy, active smoker; the minimum number of cigarettes was one cigarette per day This research was conducted in May 2018. Data collection used a tobacco dependency level questionnaire. Analysis of data using descriptive. This research is carried out by taking into account the ethical principles and has passed the ethics number 117 / EP-FKIK-UMY / II / 2018.

RESULT

Table 1. Smokers of Tobacco Cigarettes by Age and Smoking Time

Variable	Mean	Median	Min-Max	Std. Deviation
Age of Respondents (Years)	22	22	20-24	1.31
Duration of smoking (years)	5	5	3-7	0.94

Source: Primary Data, 2018

Table 2. Smokers of Tobacco Cigarettes by Gender

Variable	Frequency (n)	Persentation(%)
a. Male	41	100%
b. Female	0	0%

Source: Primary Data, 2018

The results of this study found all respondents were male. The average age of respondents using tobacco cigarettes is 22 years, with the youngest age being 20 years old and the oldest being 24 years. The duration of smoking for respondents using tobacco cigarettes is five years. The lowest smoking period for respondents using tobacco cigarettes is three years. The highest smoking period for respondents using tobacco cigarettes is seven years.

Tabel 3. Level of Withdrawal in Cigarrate Smokers

Variable	N	Percentage (%)
a. Low	13	31,7%
b. Moderate	14	34,1%
c. High	14	34,1%

Source: Primary Data, 2018

Most respondents in tobacco smokers have a high and moderate level of withdrawal then low.

Tabel 4

The score of Withdrawal Cigarette Smoker

Variable	N	Min	Max	Mean
Score of withdrawal	41	5.00	13.00	9.70

Source: Primary Data, 2018

The average score of the level of withdrawal on tobacco smokers is 9.70, with the lowest withdrawal value, which is five and the highest level of withdrawal is 13.

DISCUSSION

The majority of respondents who use tobacco cigarettes are men. According to data obtained from Pusat Data dan Informasi Kementerian Kesehatan RI, Based on sex, the prevalence of smoking has similarities from previous years, namely the prevalence of smoking in men is always higher than women. In 2013, the adult smoking prevalence increased from 65.8% in 2010 to 66%. Likewise, the proportion of female smokers adults increased from 4.1% in 2010 to 7% [18]. This is supported by the research of Amelia [1] which shows that men are very easy to experience stress and one of their ways to escape stress is to do negative actions such as the use of cigarettes and alcohol.

The average age of respondents using tobacco cigarettes is around 22 years, with the youngest age of 20 years and the oldest age between 24 years. This age falls into the category of early adulthood for students at the university. Early adulthood is a transition period from adolescence and begins at the age of 18-40 years, and in general those belonging to early adulthood are those who have aged 20-24 years). This is supported by research Evie et al. [8] which states that individuals who enter early adulthood are when they are at the age of 18-25 years. In early adulthood is a transition period where students will usually experience problems and search for self-identity which can later influence the occurrence of behaviors for smoking and related to self-confidence.

The duration of smoking for respondents using tobacco cigarettes is five years. The lowest smoking period for respondents using tobacco cigarettes is three years. The highest smoking period for respondents using tobacco cigarettes is seven years. The data is supported by research conducted by Rini et al. [15] which states that the longer a person smokes, the more cigarettes consumed. Someone who has just smoked does not mean he consumes fewer cigarettes or otherwise someone who has smoked for a long time will consume more cigarettes. This is supported by Artana and Ngurah Rai [2] study that the higher the time of smoking, the higher the level of dependence on nicotine, and the younger the age of a person smokes, the higher the level of dependence suffered.

The level of withdrawal

The level of withdrawal on respondents using tobacco cigarettes showed that the majority of respondents had high and medium and low levels of dependence. This was caused by several things, namely the number of cigarettes consumed, the frequency of smoking, and the duration of smoking, which would affect the nicotine level that enters inside the body. The nicotine content contained in one tobacco cigarette is around 1.54-2.60 mg. Inside the cigarette, there is a nicotine substance. Nicotine substances are one of the substances that can affect the level of dependence. According to USHealth [16] and Perwitasari [12], someone who has been addicted to cigarettes and is caused by nicotine usually will continue to increase the number of cigarettes smoked in one day. When you have experienced addiction due to nicotine substances contained in cigarettes, it will usually be difficult to quit smoking.

The statement was supported by Elizabeth's research (2010) cit Rosita, Suwandany, and Abidin [14] which showed that the more frequent the frequency of smoking by a person, the higher the nicotine content contained in the body. If someone smokes cigarettes continuously, then the effects of nicotine contained in the body will also be stronger and have an effect on the level of dependence that is getting higher. When the dependence on cigarettes is high, then he will continue to smoke every day which will become a habit. Thus smokers will find it difficult to abandon smoking habits. The process of the occurrence of the level of withdrawal on cigarettes begins when cigarette smoke enters through the respiratory tract such as the lungs, skin, and mucous membranes such as the inner mouth and nose. Then the cigarette smoke is absorbed, and the nicotine in cigarettes is carried to the brain through the circulatory system. Nicotine substances will reach the brain for 15-20 seconds, and the cigarette smoke is in the lungs. After that nicotine binds certain nerves to the part of the brain and the nerve stimulates the release of dopamine (DA). The effects of dopamine (DA) release can make a person feel happy, relaxed and excited. After feeling happy, relaxed and excited, then a smoker will add to the amount of nicotine dose to be able to feel the feelings and sensations repeatedly. Nicotine that has entered the body will usually be accompanied by activation of the hormone adrenaline and inhibition of the hormone insulin. After that, the body will release glucose reserves into the blood, accompanied by the absorption of glucose by the cells of the body and cause smokers to increase blood sugar levels. After that the effects of hyperglycemia (sugar in high blood) begin and can result in smokers not feeling hungry. Then the body will also produce endorphin hormones in large quantities which can cause a person to feel calm and extraordinary happiness (euphoria).

Smoking activities are influenced by several factors. Based on the results of Fathin's research (2015), the factors that can influence someone to smoke are social relationships, curiosity to try, relieve stress and want to increase self-confidence. Besides, in this study, it was explained that the application of pictorial warnings on cigarette packaging could also motivate smokers to reduce the amount of cigarette consumption and even stop smoking. The longer a person is

exposed to a warning image about the effects of the dangers of smoking contained in cigarettes, it will be possible to distance themselves from smoking behavior.

CONCLUSION

The results of this study found all respondents were male. The average age of respondents using tobacco cigarettes is 22 years, with the youngest age being 20 years old and the oldest being 24 years. The duration of smoking in cigarette smoker respondents is five years with the lowest smoking period is three years and the highest smoking period is seven years. The average score of the level of dependence on tobacco smokers is 9.70 with the lowest dependency value, which is five and the highest level of dependency level is 13. Most of the cigarette smokers have a high and moderate withdrawal level.

ACKNOWLEDGMENT

Our research was supported by a research grant from the Division of Research and Development Universitas Muhammadiyah Yogyakarta. We would like to thank The Rector of Universitas Muhammadiyah Yogyakarta, The Head of Division of Research and Development Universitas Muhammadiyah Yogyakarta, and The Head of the School of Nursing Universitas Muhammadiyah Yogyakarta for their support.

REFERENCES

- [1] Amelia, A. (2009). *Gambaran Perilaku Merokok Pada Laki-Laki*. Universitas Sumatera Utara. Retrieved from <http://repository.usu.ac.id/bitstream/123456789/14536/1/09E00589.pdf>
- [2] Artana, B. I., & Ngurah Rai, I. (2010). Tingkat Ketergantungan Nikotin dan Faktor-Faktor yang berhubungan pada Perokok di Desa Penglipuran 2009. *Jurnal Penyakit Dalam*, 11(1). Retrieved from <https://ojs.unud.ac.id/index.php/jim/article/view/3919/2911>
- [3] Badan Penelitian dan Pengembangan Kesehatan. (2013). Riset Kesehatan Dasar (RISKESDAS) 2013. *Laporan Nasional 2013*, 1–384. <https://doi.org/10.1016/j.lanjut.2013.12.001>
- [4] Bam, T. S., Bellew, W., Berezhnova, I., Jackson-Morris, A., Jones, A., Latif, E., ... Wisotzky, M. (2014). Position statement on electronic cigarettes or electronic nicotine delivery systems [Official statement]. *The International Journal of Tuberculosis and Lung Disease*, 18(1), 5–7. <https://doi.org/10.5588/ijtld.13.0815>
- [5] CDC. (2018). Health Effects of Cigarette Smoking. Retrieved from https://www.cdc.gov/tobacco/data_statistics/fact_sheets/health_effects/effects_cig_smoking/index.htm
- [6] Dawkins, L., & Corcoran, O. (2014). Acute electronic cigarette use: nicotine delivery and subjective effects in regular users. *Psychopharmacology*, 231(2), 401–407. <https://doi.org/10.1007/s00213-013-3249-8>

- [7] Dockrell, M., Morrison, R., Bauld, L., & McNeill, A. (2013). E-cigarettes: prevalence and attitudes in Great Britain. *Nicotine & Tobacco Research: Official Journal of the Society for Research on Nicotine and Tobacco*, 15(10), 1737–1744. <https://doi.org/10.1093/ntr/ntt057>
- [8] Evie., et all. (2017). Perbedaan Kepercayaan Diri Pada Mahasiswa Perokok dan Bukan Perokok di Fakultas Kesehatan Masyarakat Universitas Sam Ratulangi. *Fakultas Kedokteran: Universitas Sam Ratulangi*
- [9] Hukkanen, J., Iii, P. J., & Benowitz, N. L. (2005). Metabolism and Disposition Kinetics of Nicotine. <https://doi.org/10.1124/pr.57.1.3>
- [10] Kementerian Kesehatan, RI. (2018). *Hasil Utama Riset Kesehatan Dasar 2018*. Jakarta. Retrieved from <http://www.depkes.go.id/resources/download/info-terkini/hasil-risikesdas-2018.pdf>
- [11] Kementerian Kesehatan, R. (2019). HTTS 2019: Jangan Biarkan Rokok Merenggut Napas Kita. Retrieved from <http://www.depkes.go.id/article/view/19071100001/world-no-tobacco-day-2019-don-t-let-tobacco-take-our-breath-away-.html>
- [12] Perwitasari, R. (2006). *Motivasi dan Perilaku Merokok pada Mahasiswa Ditinjau dari Internal Locus of Control dan External Locus of Control*. Univeesitas Negeri Semarang. Retrieved from <http://lib.unnes.ac.id/6302/1/3823.pdf>
- [13] Pusat Data dan Informasi Kemenkes, R. (2018). *Situasi Umum Konsumsi Tembakau di Indonesia*. Jakarta. Retrieved from http://www.depkes.go.id/download.php?file=download/pusdatin/infodatin/infodatin_tembakau_per_halaman.pdf
- [14] Rosita R, Suswardany DL dan Abidin Z (2012). Penentu Keberhasilan Berhenti Merokok Pada Mahasiswa Fakultas Ilmu Kesehatan Universitas Muhammadiyah Surakarta. Surakarta: *Jurnal Kesehatan Masyarakat. Kemas 8(1) (2012) 1-10*
- [15] Rini., et al. (2015). Lama Merokok dan Jumlah Konsumsi Rokok terhadap Trombosit pada Laki-laki Perokok Aktif. Cimahi: *Laboratorium Patologi Klinik FK Universitas Jendral Achmad Yani*.
- [16] US Dep Health Hum Serv (2001). Risk Associated with Smoking Cigarettes with Low Machine-Measured Yields of Tar and Nicotine. *Smoking and JOM FK Vol.2 No.2 Okt 2015 7.Tobacco Control Monograph. 2001;13*.
- [17] WHO. (2014). WHO Non-communicable Diseases Country Profiles 2014. Retrieved from http://www.searo.who.int/indonesia/areas/noncommunicable_disease/en/
- [18] WHO. (2016). Prevalence of Tobacco Smoking. Retrieved June 20, 2019, from http://gamapservers.who.int/gho/interactive_charts/tobacco/use/atlas.html

Chlorhexidine Gluconate Loading, Release and Degradation in Carbonate Hydroxyapatite Scaffolding for Drug Delivery System

Ika Andriani¹, Edwyn Saleh¹,
Catur Ayuliastika², Dila Rahmanida²

¹Lecturer of School of Dentistry, Faculty of Medicine and Health Sciences Universitas Muhammadiyah Yogyakarta

²Undergraduate Student of School of Dentistry, Faculty of Medicine and Health Sciences, Universitas Muhammadiyah Yogyakarta

Jl. Brawijaya, Tamantirto, Kasihan, Bantul, DIY. Kode pos 55183

Email : ikaandriani@yahoo.com

Abstract: Tissue regeneration is one of the most important goals in periodontal treatment. Carbonate Hydroxyapatite (CHA) is a synthetic scaffold that can help bone healing process after a periodontal treatment. One of the main problem that can cause a failure in periodontal surgery is bacterial reinfection. In this case, bacterial control and bacterial elimination are very important. Chlorhexidine (CHX) is a broad-spectrum antimicrobial that works as an antiseptic that effectively kills various types of microbes including bacteria, fungi and virus. The combination of CHA membranes with antimicrobial CHX is expected to reduce the reinfection of periodontal treatment that caused by microbes. The aim of this study is to determine the ability of CHA membrane to load and release antimicrobials, in this study CHX. This study is an experimental laboratory with research design using Post Test Design. Loading was carried out by soaking 10 mg CHA membranes into 300ul CHX concentration of 0.2% with loading time 5, 10, 20, 30 and 60 minutes. The release was carried out by soaking the CHA membrane that had been loaded with CHX in the Phosphate Buffer Saline (PBS) solution. Loading, release and degradation profiles were observed to study CHA as a membrane which has the potential to be a conduit for tissue regeneration. Loading data were analyzed with Kruskal-Wallis test showed that there was no significant difference between the mean in each group treatment time ($P > 0.05$) which indicates the weight of the CHX that is loaded every 5, 10, 20, 30 and 60 minutes is the same and based on the results of the observation graph the average loading percentage shows that the longer the loading time, the lower the percentage loading value. Analysis of CHX release data with One Way Anova test showed a significance value of 0.000 ($P \leq 0.05$), which means there are significant difference between treatment groups. The amount of released CHX in each group is different. The degradation profile was observed at 1, 2, 3, 6, 24, 48 and 72 hours, and then using HCL. Analysis using One Way Anova showed the significance of data 0.000 ($P \leq 0.05$). it means that there are differences in the number of degradation values from each time. The conclusion of this study shows that 0.2% Chlorhexidine gluconate can load and release hydroxyapatite carbonate scaffold. At the same time, the

CHA membrane is also being degraded. CHA membranes have potential as CHX antimicrobial delivery systems.

Keywords: Carbonate hydroxyapatite, Chlorhexidine gluconate, delivery system, periodontal treatment

Introduction

Anatomical deformity caused by periodontitis needed a corrective therapy. Bone regeneration is expected to restore the condition and function of bones that have experienced a defect back beside it can help improve the appearance aesthetically. Regeneration of lost periodontal tissue is one of the goals of periodontal treatment. Conventional periodontal treatments such as scaling and root planing are not able to support the regeneration of lost periodontal bones, so periodontal tissue regeneration is needed.

Bone graft material can be applied to stimulate bone formation and periodontal regeneration. Human bones actually have the ability to reconstruct the defected bone, but at some cases the defect of the bone is already extend, so that it needs an intervention for bone reconstruction such as bone grafting. Bone grafting is a method that this past years has been widely used in dentistry. It is a substitute material implanted into the body to help tissue regeneration, formation of the blood clots and also for tissue remodelling. Hydroxyapatite is one of the synthetic or man-made scaffolds. This material has been widely reported as a scaffold that is biocompatible, triggers the osteoconduction process and can be absorbed by the body.

Failure of bone regeneration can be caused by local infection and tissue inflammation by bacteria. Reinfection from pathogenic bacteria is a common cause of the failure, which can lead to the development of new diseases thus, bacterial control and elimination of bacteria are very important. The use of antimicrobial therapy both locally and systemically in extensive periodontal treatment are used as adjunctive therapy to prevent the growth and development of pathogenic bacteria.

Chlorhexidine is a bactericidal agent that have the ability to kill all types of microbes including bacteria, viruses and fungi. The superiority of this antimicrobial compared to other antimicrobials is that they are safe to use and not cause any development of resistant

microorganisms. Chlorhexidine is widely used in periodontal tissue therapy including bone regeneration.

The aim of this study is to find out the ability of Carbonate hydroxyapatite (CHA) scaffold in load and release drugs in the form of Chlorhexidine gluconate related to the drug delivery system. The combination of antimicrobials in the form of Chlorhexidine gluconate (CHX) into the scaffold is expected to increase the success of periodontal bone graft treatment.

Methods

This experimental laboratory research design using the Post Test Design. Performed at the Biochemistry and Pharmacy Technology Laboratory , Faculty of Medicine and Health Sciences Universitas Muhammadiyah Yogyakarta. The materials used are Chlorhexidine Gluconate (CHX) 0.2%, Carbonate Hydroxyapatite Scaffolding (CHA), Phospate Bafer Saline (PBS).

Research preparation. Preparation of CHA membranes weight of 10 mg each and CHX solution of 300 µl each.

Loading Profile. There are 5 loading time periods; 5 minutes, 10 minutes, 20 minutes, 30 minutes and 60 minutes. The loading process is done by measure the CHA weight using analytical balance. The membrane immersed in CHX solution of 300µl using 1.5 ml microtube for a predetermined time period.

After the CHA membrane immersed in CHX solution, it measured. One ml PBS solution is added in each group of CHX solution that has been loaded to observe the absorbance value with a spectrophotometer with a wave length of 255 nm.

Analyze the CHX weight difference data and absorbance data. The CHX weight difference calculation formula is as follows:

$$\text{Loading Ratio} = \frac{W_t - W_0}{W_0}$$

Wt: weight of the loaded membrane

W0: initial membrane weight

The result of loading of chlorhexidine gluconate 0.2% on the carbonate hydroxyapatite membrane can be determined by calculating the loading percentage, that is known by calculating the absorbance value before loading (A) and the absorbance value after loading (B). The absorbance value of chlorhexidine gluconate 0.2% contained can be determined by the formula:

$$\text{Chlorhexidine Gluconate Absorption Percentage} = \left(\frac{A-B}{B}\right) \times 100\%$$

Release Profile. After the membrane loaded into CHX 0.2% for 30 minutes, PBS solution in each microtube as much 1 ml was put into the membrane to see the release profile. The sample was put into an incubator with a temperature of 37° C. The sample was divided into 5 release time groups ; 1 hour, 2 hours, 3 hours, 4 hours and 24 hours. Each group was repeated 6 times to get more accurate results. The absorbance value was measured by using a UV-Vis spectrophotometer with 255 nm wave length to determine the value of CHX release at CHA.

Degradation Profile. CHA membrane was also observed by immersing the CHA membrane in a 1 ml PBS solution.

In intervals of 1 hour, 2 hours, 3 hours, 6 hours, 24 hours, 48 hours and 72 hours, the PBS solution was replaced with a new PBS solution. After 72 hours, the PBS solution was replaced by a strong acid solution in the form of HCl. The absorbing PBS solution was measured by using UV-Vis spectrophotometer with a wave length of 255 nm to determine the degradation value of the CHA membrane.

Result

Table 1. Loading Ratio in Each Group

Time (minutes)	5	10	20	30	60
W ₀ (mg)	10	10	10	10	10
W _t (mg)	60	55,3	63	50	54,3
Loading Ratio (mg)	5	4,53	5,30	4	4,43

The results of laboratory research. Loading ratio in each interval time is shown in table 1.

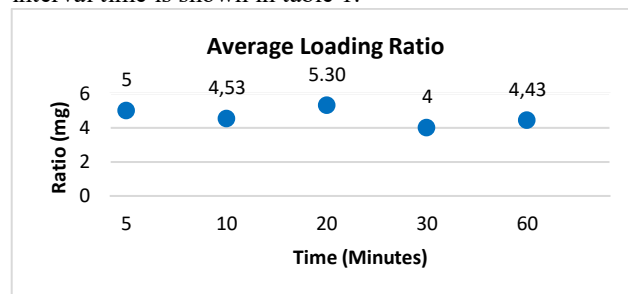

Graphic 1. Average of Loading Ratio to each group of time.

Table 2. The Result of *Kruskal Wallis* statistic test in Loading Ratio sample.

Time (minutes)	5	10	20	30	60	Asymp. Sig.
Mean Rank	10,17	7,50	12,33	4,00	6,00	0,157

Table 3. Loading Percentage of Absorbance of *Chlorhexidine Gluconate*

Time (minutes)	5	10	20	30	60
Loading Percentage (%)	19,028	18,661	18,331	16,623	15,876

The percentage of absorbance value of *chlorhexidine gluconate* is shown in Table 3.

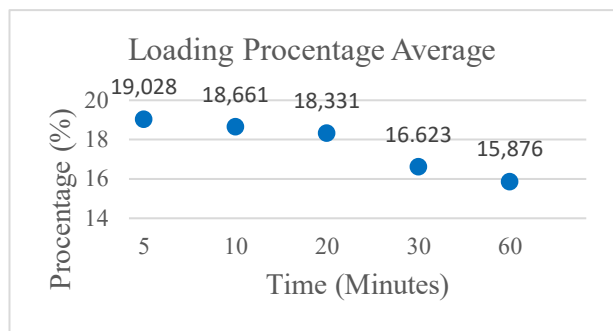

Graphic 2. Average of Loading Percentage in each group of time.

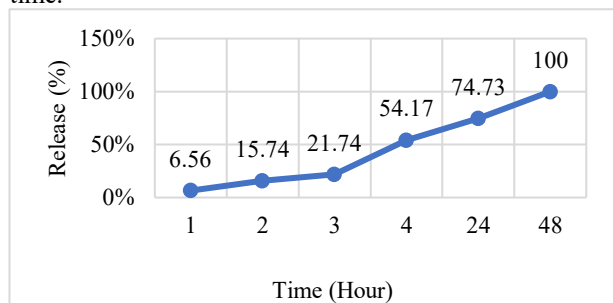

Graphic 3. Percentage of Chlorhexidine Release.

The graphic above shows that Chlorhexidine (CHX) contained in the CHA membrane has sustained release. The CHX release chart continues to increase and CHX is still released for up to 48 hours. One Way Anova test result is obtained a significance value of 0.000 ($p \leq 0.05$). A sig p value of 5 0.05 indicates that there are significant differences between these groups. That means there is a difference in the number of CHX that is separated from each time.

The degradation profile of CHA membrane can be seen from the absorbance value of CHA membrane that is immersed in Phosphate Buffer Saline (PBS) for 1 hour, 2 hours, 3 hours, 6 hours, 24 hours, 48 hours to 72 hours. At each of these times, the PBS solution was replaced with a new solution, and the PBS solution was measured for its absorbance value. After 72 hours, PBS solution was replaced with strong acid HCl. The average absorbance value data is converted into graphical form and the following graph is obtained:

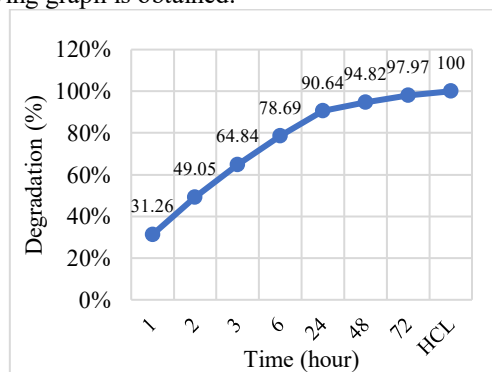

Graph 4. Percentage of Chlorhexidine Degradation

In graph 4, shows the significant degradation that took place at each time. Within 2 hours, almost 50% of the CHA membrane was degraded. At the same time, 15.74% CHX was released from this CHA membrane.

The percentage of Chlorhexidine release from the CHA membrane at each time followed by the degradation of the CHX membrane. Nearly 50% of the membrane is degraded within 2 hours, at the same time, as much as 15.74% CHX is separated from the membrane.

Discussion

Loading

The most effective time of membran loading is 20 minutes, illustrated on Graph. 1. The membran started to degradating in more than 20 minutes, indicated by reduction of CHX loaded, after 20 minutes. Research by Wacharanad et al., (2016) showed that the absorption of CHX has high value at the 20 minutes. Based on Kurskal Wallis statistic test, the difference weight of loaded CHX has a significant value of 0.157. It means, p value > 0.05, H0 accepted, which means there is no difference in each treatment group.

Absorbance result showed that the longer the loading time, the higher the absorbance value. The result of average percentage of loading illustrated on graph. 1, showed that the longer the loading time, the lower the value of loading percentage. This result is consistent with the research by Ardhani et al., (2016). This study showed that CHA membrane, not only designed as scaffold in regeneration of periodontal tissue, but also had a function to load a drug.

The mechanism that is used to load CHX into the CHA membrane is the electrostatic force. CHA membranes have tensile strength and a porous membrane structure. Therefore, when loading CHX into the CHA membrane, the attractive force between negative and positive charge drive CHX loading into the CHA membrane.

CHA membrane material in this research was made from gelatin and hydroxyapatite. Gelatin is the result of partial hydrolysis of collagen by natural products and is a protein that is able to dissolve and made of animal skin and bones. There are two types of gelatin, the type made of young animal skin through the softening process using an acid solution, while the type of gelatin that comes from the skin and bones of an old animal and its immersion uses a basic solution and takes a long time in the immersion process. From gelatin ingredients which are related to the presence of very high protein. It has a function as a binder, enriches nutrition, can form a thin film that is elastic, and forms a transparent and strong film.

Hydroxyapatite is a ceramic that has good biocompatibility properties, because the chemical and physical of the mineral content is same as bones and teeth in humans. Hydroxyapatite is a bioactive ceramic, it has a function as a medium for drug delivery (drug delivery).

Release

There are consistency between the result of this study and the research by Shubra Malik et al. (2015). The result of that study said that the release of CHX without membrane has faster release time, which is almost 100% within 4 hours. Meanwhile the release of CHX using membran CHA as delivery system, the release time is slower; only 59% of CHX was released. It shows that CHX membrane can provide a sustainable release for CHX.

Swelling of the microspheres that occur, can affect the mobility of the gelatin chain and thus, it can facilitate the release of drug by polimer diffusion. Drug release can be

controlled by a gelatin membrane depend on the composition of glutaraldehyde in gelatin which is responsible for the formation of cross bonds.

Both Gelatin with Hydroxyapatite are the basis ingredients to make membranes. Comparison between Gelatin with Hydroxyapatite can also influence the percentage of CHA membrane release and degradation. According to research by Nindiyasari et al., (2014), scaffold with various concentrations of gelatin will affect the structure of hydrogel porosity, which is, the smaller the concentration of gelatin will increase the porosity of hydrogel that can affects the attachment of surrounding cells, in that study, platelete rich plasma cells.

According to Ardhani's 2012 study, it stated that the CHA membrane is not only designed as a scaffold in the process of regenerating periodontal tissue, it can also has function as a delivery membrane.

The result of this study show that there are release of CHX combined with CHA membrane. The release of CHX followed by the degradation of CHA membrane. Beside it is used as delivery system, CHA membrane is also safe for human body tissue for it is biodegradability. This study also showed that CHA membrane can release CHX simultaneously.

Conclusion

Based on this research, it can be concluded that Carbonate Hydroxyapatite (CHA) membrane can be used as a drug delivery system.

Suggestion.

Further research for periodontopathogen antibacterial test followed by in vivo test are needed.

Acknowledgement.

This study funds was supported by LP3M Universitas Muhammadiyah Yogyakarta. We would also like to express our gratitude for Drg. Ika Dewi Ana, MKes., PhD for providing CHA membrane and for her full support on our research.

References

1. Reynolds, M. A., Aichelmann-Reidy, M. E., & Branch-Mays, G. L. (2010). Regeneration of periodontal tissue: bone replacement grafts. *Dental Clinics*, 54(1), 55-71.
2. Dumitrescu, L. (2011). Bone graft and bone graft substitutes in periodontal therapy. *Chemicals in Surgical Periodontitis Therapy*, 73-144.
3. Chaeriyana, R., Ridho, F., & Badriananto, A. (2013). Peningkatan jumlah pembuluh darah akibat aplikasi graft hidrogel-CHA pada soket pasca pencabutan gigi (kajian in vivo). *BIMKGI*, 1 no 2 edisi Januari-Juni, 14-18.
4. Valiense, H., Fernandes, G. V. D. O., Moura, B., Calasans-Maia, J., Alves, A. T. N. N., Rossi, A. M., & Calasans-Maia, M. (2012). Effect of Carbonate-apatite on bone repair in non-critical size defect of rat calvaria. In *Key Engineering Materials* (Vol. 493, pp. 258-262). Trans Tech Publications.
5. Lovegrove, J. M. (2004). Dental plaque revisited: bacteria associated with periodontal disease. *Journal of the New Zealand Society of Periodontology*, (87), 7-21.
6. Kaplowitz, G. J., & Cortell, M. (2005). Chlorhexidine: a multi-functional antimicrobial drug. *Peer reviewed publication. The Academy of Dental Therapeutics and Stomatology*.
7. Wacharanad, S., Sasimomthon, W., Wongyai, P., Vudhivanich, A., & Tippawan, K. (2016). Activity of chlorhexidine gluconate loaded at varying polyelectrolyte. *MATEC Web of Conferences*, 1-5.
8. Ardhani, R., Setyaningsih, Hafiyah, O. A., & Ana, I. D. (2016). Preparation of Carbonated Apatite Membrane as Metronidazole Delivery System for Periodontal Application. *Key Engineering Materials*, 696, 250-258.
9. Matsui, M., & Tabata, Y. (2012). Enhance angiogenesis by multiple release of platelet-rich plasma contents and basic fibroblast growth factor from gelatin hydrogels. In *Elsevier* (pp. 1-10).
10. Ardhiyanto, H. (2011). Peran hidroksiapatit sebagai bone graft dalam proses penyembuhan tulang. *Stomatognatic*, 8, 118-21.
11. Malik, S., Taneja, S., Chadha, R., & Kumari, M. (2016). Effect of Chitosan on sustained release chlorhexidine-an in study. *Journal of vitro Dental Specialities*, 4(1), 21-2
12. Dinarvand, R., Mahmoodi, S., Farboud, E., Salehi, M., & Atyabi, F. (2005). Preparation of gelatin microspheres containing lactic acid—Effect of cross-linking on drug release. *Acta pharm*, 55(1), 57-67.
13. Nindiyasari, F., Fernandez-Diaz, L., Griesshaber, E., Astilleros, J. M., Sanchez-Pastor, N., & Schmahl, W. W. (2014). Influence of gelatin hydrogel porosity on the crystallization of CaCO₃. *Crystal Growth & Design*, 14(4), 1531-1542.

Correlation between Internet Addiction Disorder and Prevalence of Withdrawal Symptoms in Late Childhood

Prima Hari Nastiti¹, Yelvi Levani¹, Sukadiono¹ and Irwanto²

¹Medical Faculty, Muhammadiyah University of Surabaya

primaharina99@gmail.com

²Growth and Development of Children Division, Department of Paediatric, Medical Faculty, Airlangga University of Surabaya

Abstract - As the internet is increasingly accessed by a wide variety of users – ranging from children to adults, such effects are inevitable, one of which is internet addiction disorder. Internet Addiction Disorder's risk develops 3.1 times higher during the late childhood stage. This affects dopamine activities which lead to withdrawal symptoms afterward. The objective is investigate the extent of internet addiction during late childhood and to examine its relationship to the withdrawal symptoms. Methods: This is an analytical observational study with the cross sectional approach. Stratified random sampling technique was conducted using questionnaires, with the total of 170 Elementary School students, aged 6-12 years. The data were analyzed using Chi Square. Results: Various levels of internet addiction disorders among the subjects (31% mild, 64.3% moderate, and 4.65 % severe) were obtained. The prevalence withdrawal symptom is 77% from total subjects with the internet addiction disorders. There was a significant positive correlation between internet addiction disorders and withdrawal symptoms. Conclusions: Internet addiction was present in late childhood and it has a significant correlation with withdrawal symptoms. Further study is required to deal with the internet addiction in this specific population.

Keywords: Internet addictive disorder, withdrawal symptoms, cyber kids

A Introduction

As the internet is increasingly accessed by a wide variety of users – ranging from children to adults, such effects are inevitable, one of which is internet addiction disorder. Consequently, if they are not careful in addressing and using, it can have a negative impact on them. The easy availability of the internet has its own problems that psychiatrists around the world have begun to realize recently. This has an addictive potential (1).

Children commonly called as cyber kids, as part of the society, greatly experience this social impact. Internet Addiction Disorder's risk develops 3.1 times higher during the late childhood stage. This affects dopamine activities which lead to withdrawal symptoms afterward. Parents who grant an internet access for children aged 3 -11 years must be assessed and reviewed, at least in the form of several screening devices or questions about media use. It is important to understand how children use their technology

and devices, in general, through a comprehensive media screening testing Health professionals as therapists have a clear perception on the behavior and functional analysis of the use of technology at home and at school in children (2). While the maximum use of the internet can still be controlled, the loss of the ability to control the frequency and duration of internet activity increasingly appears in some users. As a result, an excessive time spent on the internet use and the narrowing of the behavior can cause serious psychosocial outcomes. This phenomenon is referred to as "Pathological Internet Use" (PIU) or "Internet Addiction." Similar to the substance use disorder, most patients with Internet Addiction Disorder (IAD) experienced withdrawal symptoms. Individuals with chemical addictions often show psychotic symptoms; almost half of those who abuse cocaine (47.7%) or cannabis (44.8%) was reported experiencing psychotic symptoms during the use or withdrawal of certain substances. In other cases, it has been shown that addictive behaviors such as IAD can cause psychosis withdrawal in some vulnerable individuals. Withdrawal symptoms may occur when the internet is taken away: these symptoms are typically described as an irritability, anxiety, or sadness (3).

Based on the description above, the correlation between internet addiction and symptoms of withdrawal starts at the age of childhood. Therefore, the researcher was interested in calculating the number of the internet addiction disorder sufferers and their severity, as well as the prevalence of withdrawal symptoms and their correlation.

1. Methods

This paper was conducted by using an analytical observational study with the cross sectional approach. The sample was collected using the stratified random sampling technique with the total of 170 students aged 6-12 years from a private Islamic Elementary School. Since the respondents were considered not mature enough to complete questionnaires, the parents' respondents were asked to fill out Internet Addiction Test (IAT) questionnaires in Bahasa Indonesia. The respondents involved in this current study were the ones who used the Internet at least more than two months and whose parents agreed to fill out the questionnaires. Incomplete questionnaires were excluded from the study. Finally, the current project was reviewed and approved by the Ethics Committee of Medical Faculty Muhammadiyah University

of Surabaya. We determined the size of the sample population (p) being studied by means of a bilateral interval with a 95% confidence interval with an estimation of error limits $\pm 5\%$ ($B = 0.05$) and considering a conservative approach ($p = q = 0.5$) and using Chi square analysis.

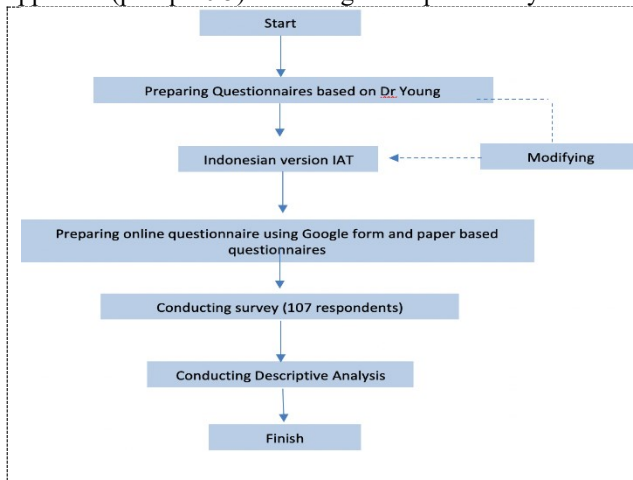

Figure 1. Research Workflow

The total IAT score is the number of rating given by participants willing to fill out the questionnaires comprised of 20 question items. Each item is rated on a 5-point scale from 0 to 5. The maximum score is 100 points. The total IAT score range is the higher score representing the higher level of compulsive severity and internet addiction. From the 20 questions above, the distributed IAT questionnaires had 20 questions each of which having a minimum value of 0 and a maximum of 5. The total assessment obtained was to add up the scores. Grouping total values are based on the following.

- 0-30: Normal internet usage
- 31-49: Mild internet addiction
- 50-79: Moderate internet addiction (moderate)
- 80-100: Severe internet addiction

Previous research addressing the sensitivity and validity of these score ranges has been published in several journals. The IAT is validated in several languages, so the examiner should review the correct study based on the language used for administering.

2. Results

This study was conducted at one of the private elementary schools in Surabaya. The characteristics of the students in this school varied in a considerable amount in terms of the socioeconomic level. Before conducting the study, the researcher asked for informed consent to the school committee chairman to distribute the research questionnaires. There were 170 parents agreed to fill out the questionnaire. With the distribution of research respondents aged 6 - 12 years, respondents in Class 1 were 31 students, 31 students from Class 2, 27 students from Class 3, 28 students from Class 4, 32 students from Class 5 and 21 students from Class 6.

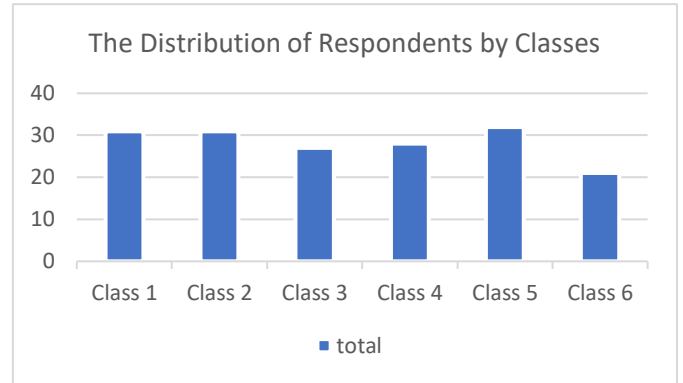

Chart 1. The Distribution of Respondents by Classes

Viewed from gender, the number of male respondents is 88 students and the female respondents is 82 students. The completed data about the distribution of respondents by gender can be seen in chart 2.

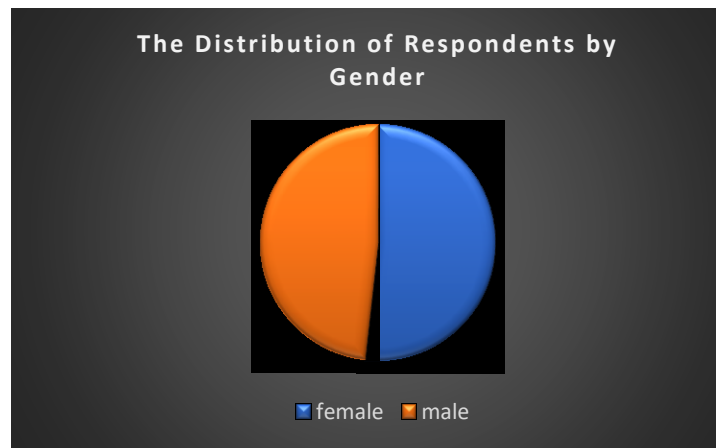

Chart 2. The Distribution of Respondents by Gender

On chart above, it can be seen that most of the respondents are male, that is equal to 51.76%, although the comparison with female gender shows not much difference.

The chart below shows the distribution of respondents based on the average length of internet usage per day.

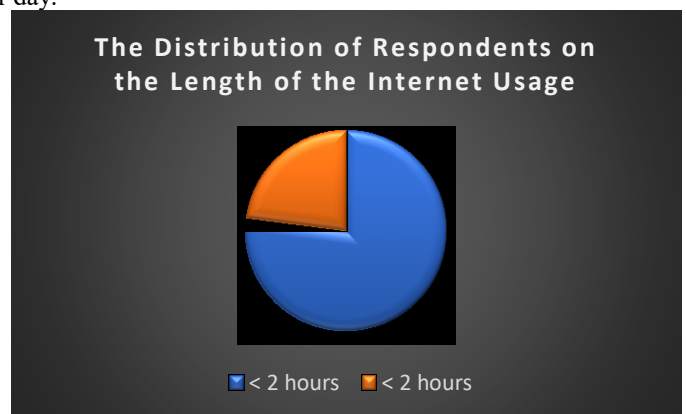

Chart 3. The Distribution of Respondents by Gender

Based on the chart above, most students use the internet on average > 2 hours per day. Moreover, 39 students (23%) use the internet < 2 hours per day.

The chart below shows the distribution of respondents based on the internet quota they get every month.

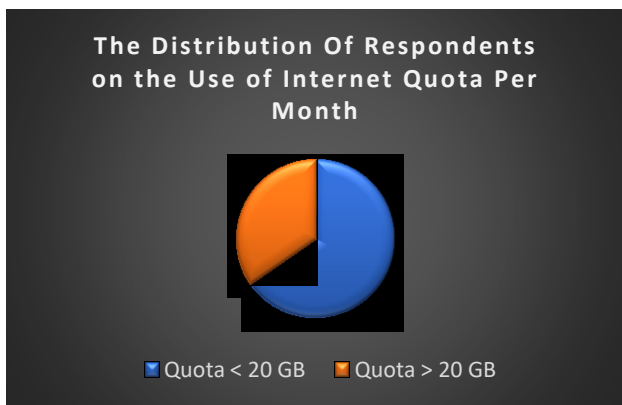

Chart 4. The Distribution of Respondents to the Use of Internet Quota Per Month

The chart above shows the internet quota characteristics used every month. It can be seen that most parents of students in this school buy quota > 2 GB per month. Meanwhile, 28 people use quota < 2 GB per month (30.8%).

The completed data regarding the distribution of respondents on internet sites that are often accessed can be seen in the chart below.

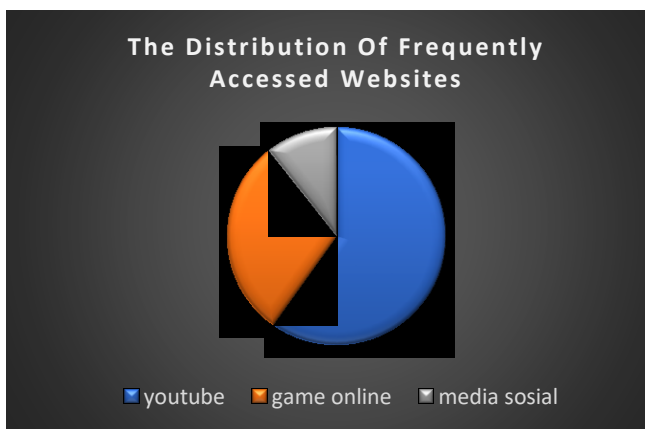

Chart 5. The Distribution of Frequently Accessed Websites

In the chart above, it can be seen that the sites most frequently accessed by students are YouTube at 94.5%, followed by online game applications, of 93.4% and the least is the social media of 8.8% where respondents explain, the examples are like Tiktok, Instagram and Whatsapp.

Various levels of internet addictive disorder among the subjects are 31% mild, 64.3% moderate, and 4.65 % severe. The prevalence withdrawal symptom is 77% from total subjects with internet addictive disorder.

Table 1. Level of Internet Addictive Disorder

Level of Internet Addictive Disorder	Number
Mild	48 students
Moderate	116 students
Severe	6 students
Total	170 students

A percentage is used to calculate the level of internet addiction among students. This is to ensure on which level the students in Private Elementary School belong to. The results are categorized in three categories, namely: Mild level, Moderate level, and Severe level users with the internet addiction. Therefore, the result will be analyzed using these three categories. Table 1 shows that students who experience mild internet addiction with the range of IAT 1-30 scores are 48 people (28,2%). Meanwhile, those of the moderate internet addiction with the IAT score range 31-60 are 116 people (68,2%). In addition, students with the severe internet addiction of the IAT 61-90 score range are as many as 6 people (3,5%). As a conclusion, the level of internet addiction among the students of the Private Islamic Elementary School is moderate and tends to minimal.

Table 2. Withdrawal symptoms

Withdrawal Symptoms	Number
Yes	141 students
No	29 students
Total	170 students

The percentage is used to calculate the prevalence of withdrawal symptoms among students. This is of the prevalence of withdrawal symptoms among students at the Private Islamic Primary School. The results are categorized into two categories: Yes and No withdrawal symptoms. Thus, the results will be analyzed based on these two categories. Based on table 2, 82.9% (n = 141) students were with withdrawal symptoms and only 17.1% (n = 29) without withdrawal symptoms. In conclusion, the prevalence of withdrawal symptoms among those students of the Private Islamic Primary School is higher than those without withdrawal symptoms.

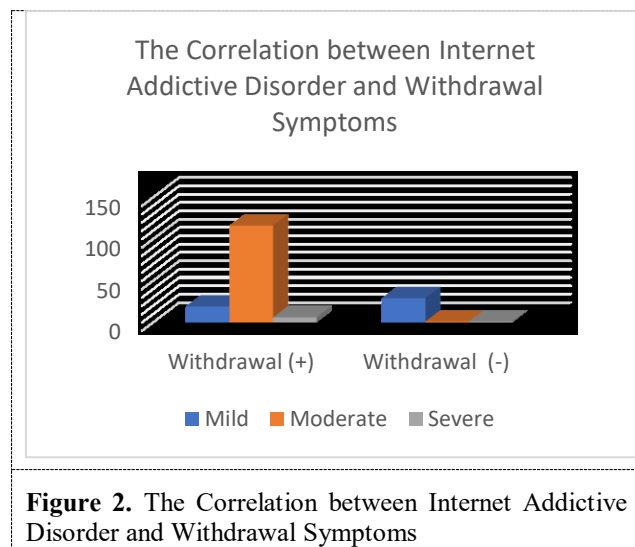

Figure 2. The Correlation between Internet Addictive Disorder and Withdrawal Symptoms

The results of Chi-square test show that there was correlation between internet addictive disorder and withdrawal symptoms among students of the Private Islamic Elementary School, $\chi^2 (1, n = 170) = 0.00$. Hence, the first hypothesis is accepted.

3. Discussion

The internet site most frequently accessed by late childhood is Youtube. This results are having conformity with the research conducted by the Association of Indonesian Internet Service Providers. This institution claimed that the type of internet content accessed by Indonesian internet users at the age of 10-14 is Youtube with a number of users reaching up to 768,000 people (4). According to a survey, there was a substantial increase in the internet usage between 2016 and 2017. YouTube usage is still the most frequently accessed website at the children age. Compared to the previous year, almost half of the age 3-4 years (45%) has used it and up to 89% at the age of 12-15 years. However, this year has shifted between the ages of 8-11 years in the way they prefer to see the content, with a significant increase in groups (who watch YouTube and TV) saying that they prefer watching YouTube content rather than watching TV programs (49% vs 40% in 2017). This increase between 8-11 means that there is a clear preference for watching YouTube content rather than TV programs, both between 8-11 (49% vs 14%) and 12-15 (49% vs 16%). (2)

According to the study results concerning internet addiction, the students who experience the mild internet addiction with the range of IAT 1-30 scores are 48 people (31%). Those with the moderate ones in the IAT score range 31-60 are 116 people (48%). Meanwhile, the severe internet addiction in the IAT 61-90 score range are as many as 6 people (4,65%). The prevalence of internet addiction varies throughout the world. This study results the same with that carried out in several developed countries, such as the United States and Europe, showing the prevalence of the internet addiction from 7.9% to 25.2% among adolescents (5). Furthermore, in the Middle East and surrounding areas, it has increased from 17.3% to 23.6% (6). Studies in Asia have shown a higher variation in the prevalence of young people and adolescents, ranging from 8.1% to 50.9% (7). In China, there has been an increase ranging from 6% to 10% (8).

Internet addiction is the behavior of computer use and internet access that is not well controlled and causes excessive preoccupation, which causes disruption or distress (9). Internet addiction was first investigated in 1996 by the American Psychological Association (APA). APA reviewed more than 600 cases of internet addiction showing clinical signs of addiction measured through a customized version of DSM-IV criteria for pathological gambling (10). Another study also linked internet addiction to addiction disorders, classifying it as an addition to alcohol and drug addicts, obsessive-compulsive disorder (11), and impulse control disorders (12). Internet addiction is excessive, or improperly controlled, preoccupation, and behavior about using the Internet causing disruption or difficulties in several domains of life.

The phenomenon of protracted online that happens to someone becomes one of the symptoms that someone has an internet addiction. The excessive use of the internet also damages family relationships, self-esteem, life satisfaction, academic achievement, and semantic verbal fluency. Internet addiction has characteristics, such as loss of control, disability to reduce the consumption of addictive things, and the feeling of intense pleasure. This can be in the form of dependence on online games, chat rooms, pathological online gambling, or compulsive online shopping. This study

requires improvements or adjustments for the questionnaires based on the development of the era and the subject under study. The description clinically found is preoccupation, having experienced a failure in the effort to stop or reduce the level of internet usage, longer online activities than planned. These are symptoms of withdrawal and psychosocial consequences (13). The research results of the analysis were obtained at 0.00, indicating the correlation between internet addictive disorder and withdrawal syndromes. A positive p value indicates that there is a positive correlation among the variables meaning that the higher the score of the independent variable (internet addiction), the higher the variable score (withdrawal symptoms). Research on internet addiction and withdrawal symptoms shows the excessive use of the internet to produce individual difficulties with the people around them associated with an increased frequency of withdrawal symptoms from them. Because of the excessive use of the internet, valuable time used to support with family, friends, are replaced into smaller social circumscriptions where win rates and stress are higher (14). In accordance with previous studies conducted in China, this study was conducted to determine the correlation between internet addiction and depression in children (ages 8-17 years). The results showed the depression carried out by children referred to as the internet (15).

One of the criteria which is often referred to as a withdrawal symptom is when an internet user feels dissatisfactory, extremely angry, or stressed out if they can't access the internet. It is not easy to stop suddenly from doing things intensively for sometimes then just stop doing it or the internet just disappears. Withdrawal symptoms are unpleasant feelings that occur due to the use of the internet that is reduced or discontinued, resulting in affecting the physical and psychological condition of the individual itself (16). Physical effects that often occur such as dizziness and insomnia, with psychological effects like irritability and moodiness. It can be concluded that withdrawal symptoms are a symptom causing dissatisfaction among individuals when not using the internet (1).

Related to issues such as students who feel sad, uncomfortable and irritable when not using the internet, the results revealed the level of internet addiction in early adolescents based on the indicators. Withdrawal symptoms are mostly in the moderate category, shown from 240 students examined, 118 students of whom have withdrawal symptoms that are in the medium category and only 20 students whose withdrawal symptoms were categorized as low (17).

Qualitative research studies conducted by Wan and Chou (2007) show that the factors influencing addiction behavior of playing online games include: self-control, motivation, psychological needs (desire for power), desire to achieve, and loneliness (18). The frequency of playing online games is also the reason why people are increasingly bound and become addicts (11). *The previous study* also states that there are two factors causing children to be addicted to playing online games, namely internal and external factors (16). Internal factors include the strong desire among children to get high scores in online games, the feeling of boredom when they are at home or at school, their inability to set priorities for

doing other important activities, and lack of self-control among them. External factors occur in the form of uncontrolled environment because their friends also play a lot of online games, their lack of good social relations. Moreover, their parents' expectations are too high for their children to take part in academic tutoring or activities.

The excessive internet using occurs because of poor time management by the internet users; they are easy to forget the time during online (19). Individuals who show symptoms of internet addictive disorder will lead to mental emotional problems, among which can cause time distortion, less attention, hyperactivity and irritability (16). Furthermore, from the results of the Brenner's study, 80% of the 600 respondents indicated at least five problems related to the internet usage, such as failure to manage time, not sleeping, not eating, and others. Based on several clinical evidence presented above the internet addiction has included in disorders in the latest DSM - V. Because of the internet addictive disorder, very broad negative effects on both mental and physical health of individuals have been reported. Earlier recognition for screening the internet addictive disorders in late childhood is very useful for quickly finding appropriate treatment and prevention measures to reduce the impact and can be a reference for other research in the future. The excessive internet using increases an urgency in dealing with this problem, especially if it has been done since the age of school children (20).

The researchers tried to raise the problem of internet addictive disorder (IAD) in school-age children as an issue that would be prevented using appropriate interventions. Researchers are interested in taking samples of school-age children because at this period, children are more often vulnerable to internet using.

4. Conclusion

This current study provides compelling evidence for the internet addiction that presents in late childhood. Moreover, it has a significant relation to withdrawal symptoms. Recommendations in this study include recommendations for parents, government and further research. Parents are advised to be more actively involved in their children internet use. They are advised to ensure that the websites accessed by their children contain educational entertainment content for elementary school-age children. For the government, it is recommended to make regulations regarding screening time on the use of late childhood.

5. References

- Jenni, O.G. Starting the debate: rethinking well-child care in Europe. *J Pediatr.* 2016;(179):276–277.
- Child Trends DataBank. Home computer access and internet use: indicators of child and youth well-being [Internet]. CTDB. 2015 [cited 2017 Oct 2]. Available from: https://www.childtrends.org/wp-content/uploads/2015/12/69_Computer_Use.pdf
- Goldberg I. Internet Addictive Disorder (IAD) diagnostic criteria [Internet]. webcitation. 2013 [cited 2017 Oct 2]. Available from: <http://www.webcitation.org/query?url=http%3A%2F%2Fwww.psycom.net%2Fiadcriteria.html&date=2013-02-06>
- Asosiasi Penyelenggara Jasa Internet Indonesia [APJII]. Profil Pengguna Internet Indonesia. In Jakarta: Asosiasi Penyelenggara Jasa Internet Indonesia; 2014.
- Durkee, T., Kaess, M., Carli, V., Parzer, P., Wasserman, C., and Floderus, B. Prevalence of pathological internet use among adolescents in Europe: demographic and social factors. *Addiction.* 2012;107:2210–2222.
- Ghasemzadeh L., Shahraray M., Moradi A. Investigation of the rate of prevalence of addiction to internet in female students, comparison of addicted female with non-addicted females concerning such variables as loneliness, self-respect and social skills. *Iran J IPA.* 2014;2(3):32–40.
- Kim K., Ryu E., Chon M. Internet addiction in Korean adolescents and its relation to depression and suicidal ideation: A questionnaire survey. *Int J Nurs Stud.* 2006;34(2):185–92.
- Koyuncu, T., Unsal, A., and Arslantas, D. Assessment of internet addiction and loneliness in secondary and high school students. *J Pak Med Assoc.* 2014;64:998–1002.
- Cheng, C. and Li, A.Y. Internet addiction prevalence and quality of (real) life: a meta-analysis of 31 nations across seven world regions. *Cyberpsychol Behav Soc Netw.* 2014;17:755–60.
- American Psychiatric Association (APA). Diagnostic and statistical manual of mental disorders. 5th editio. Washington, DC: APA Press; 2013.
- Kuss, D.J., Griffiths, M.D., Karila, L., and Billieux, J. Internet addiction: a systematic review of epidemiological research for the last decade. *Curr Pharm Des.* 2014;20:4026–4052.
- Shapira N, Goldsmith T, Keck Jr P, et al. Psychiatric features of individuals with problematic internet use. *J Affect Disord.* 2000;57:267–72.
- Kaess, M., Durkee, T., Brunner, R., Carli, V., Parzer, P., and Wasserman, C. Pathological Internet use among European adolescents: psychopathology and self-destructive behaviours. *Eur Child Adolesc Psychiatry.* 2014;23:1093–1102.
- Nie N., Erbring L. Debating the societal effects of the internet: connecting with the world. *Public Perspect.* 2008;11(3):42–3.
- Kawabe, K., Horiuchi, F., Ochi, M., Oka, Y., and Ueno, S. Internet addiction: prevalence and relation with mental states in adolescents. *Psychiatry Clin Neurosci.* 2016;70:405–412.
- Fitri, E., Zola, N., & Ildil, I. Profil Kepercayaan Diri Remaja serta Faktor-Faktor yang Mempengaruhi. *JPII (Jurnal Penelit Pendidik Indones.* 2018;4(1):1–5.
- Dhyan S. A systematic review of literature on effect of Internet use on students in India [Internet]. *Online International Interdisciplinary Research Journal.* 2017 [cited 2017 Oct 2]. Available from: https://www.researchgate.net/publication/273538253_A_Systematic_Review_of_Literature_on_effect_of_Internet_Use_on_Students_in_India.
- Wan, C.S. & Chou, W.B. The motivations of adolescents who are addicted to online games: a cognitive perspective. *Adolescence.* 2007;42(165):179–97.
- Rodgers, K. S. Y. & R. C. The Relationship Between Depression and Internet Addiction. *Cyberpsychology Behav.* 1998;1(1):22–8.
- Ferrara, P., Corsello, G., Sbordone, A., Cutrona, C., Ehrlich, J., and Pettoello-Mantovani, M. The role of pediatricians in caring for the well-being of children living in new types of families. *J Pediatr.* 2016;176:226–228.

Acknowledgments

We would like to thank to the rector of Muhammadiyah University of Surabaya, the dean of Faculty of Medicine Muhammadiyah University of Surabaya, our colleagues and family.

The Relation between Nurses’ Spiritual Intelligence and Patients Spiritual Needs Fulfillment: Cross Sectional Study

1st Syahruramdhani Syahruramdhani

School of Nursing, Faculty of Medicine and Health Sciences
 Universitas Muhammadiyah Yogyakarta
 Yogyakarta, Indonesia
 syahruramdhani@umy.ac.id

2nd Wawan Sugianto

School of Nursing, Faculty of Medicine and Health Sciences
 Universitas Muhammadiyah Yogyakarta
 Yogyakarta, Indonesia

Abstract—Nurses who have good spiritual intelligence are used to build awareness on the basis of worship and the help of human needs. Spirituality can help patients to understand the way of life and find their confidence. Therefore, they can be able to and find hope, inner harmony and composure. The purpose of this study was to determine the relationship between nurses spiritual intelligence with fulfilling patients spiritual needs in the hospital ward PKU Muhammadiyah Gamping. This research used quantitative method with cross sectional research design. The sample in the study were 91 nurses who worked and served in the wards of PKU Muhammadiyah Gamping Hospital and were willing to fill out the questionnaire which is determined by simple random sampling method. Most of the nurses at PKU Muhammadiyah Gamping have spiritual intelligence in good category (82.4%) and fulfilling patients spiritual needs with good category (62.6%). The result of statistical analysis showed that there is relation between nurses spiritual intelligence and fulfilling patients spiritual needs with value $p = 0.002 (<0.05)$. The findings indicated that nurses' spiritual intelligence is an important value and has relation with patients spiritual needs fulfillment. The better the spiritual intelligence a nurse has, the better the act of spiritual care that will be done to meet the spiritual needs of the patient. The further study is needed to know the effect of nurses’ spiritual intelligence toward patients spiritual needs fulfillment.

Keywords—spiritual intelligence, spiritual needs, nurses

I. INTRODUCTION

Humans are seen as holistic beings in nursing which include bio-psycho-spiritual-cultural. This is a nursing principle that not only is the biological aspect considered in nursing care but also looks at other aspects [1]. Spiritual aspects cannot be separated from the provision of nursing care to patients and an integral part of nurse-patient interaction. Spiritual distress can cause disharmony with oneself, others, the environment and God [2]. Wahab and Umiarso [3] argued that people with spiritual intelligence can maintain harmony in their daily lives and be humanistic towards others. According to Vaughan [4], one of the characteristics of a spiritually healthy person is someone who has social responsibility, showing concern for others, having a willingness to help when seeing other people's distress, and giving more than receiving.

Sukidi [5] stated that someone will live life wisely and feel the peace of the soul if spiritually intelligent and will have an impact on their interactions in daily life in the form of patient behavior, empathy, compassion, showing feelings of calm and peace, humility, warmth and inner strength. The study from

Wahyuni et al [6] with the title of the relationship between spiritual intelligence and pro-social behavior on nurses in the hospital Islamic Banjarmasin showed that there is a strong positive relationship between variables of spiritual intelligence and pro-social behavior on nurses. The other research conducted by Merianti and Anhdika [7] showed that there was a relationship between spiritual nurse quotient competence in spiritual care at Ibnu Sina Padang Panjang Islamic Hospital in 2013.

Based on this background, researchers want to do research about Relationship between Nurse Spiritual Intelligence and Fulfillment of Patient's Spiritual Needs..

II. METHODS

This study used a method quantitative descriptive with cross sectional approach. The study took place in April 2018. Respondents in this study were nurses in the wards of PKU Muhammadiyah Gamping Hospital with a population of 117 nurses and a sample of 91 nurses was determined using random sampling. The inclusion criteria in this study were nurses who work at PKU Muhammadiyah Gamping Hospital and served patients in wards. The exclusion criteria is nurses who were not present at the time of data collection and not on duty in the inpatient ward. This study has obtained an ethical licensed from Ethics Commission of Faculty of Medicine and Health Sciences Universitas Muhammadiyah Yogyakarta with letter number: 207/ EP-FKIK-UMY/IV/ 2018. The data were analyzed by univariate and bivariate analysis. Bivariate analysis was conducted using Spearman Rho.

III. RESULT

Table I shows that there are 68 (74.7%) female respondents who have more female characteristics, 82 (90.1%) in early adulthood, and 46 (50.5%) in Bachelor degree for education person.

TABLE I. CHARACTERISTIC OF SUBJECT

Characteristic	Total	Percentage (%)
Sex		
Female	68	74.7
Male	23	25.3
Age		
Early Adulthood	82	90.1
Late Adulthood	9	9.9
Level of Education		
Bachelor	46	50.5
Diploma	45	49.5

Table II shows that 75 (82.4%) respondents have good spiritual intelligence.

TABLE II. 2. NURSES SPIRITUAL INTELLIGENCE

<i>Spiritual Intelligence</i>	<i>Number</i>	<i>Percentage (%)</i>
Good	75	82.4
Fair	16	17.6
Poor	-	-
Total	91	100

Table III shows that 57 (62.6%) respondents had good spiritual needs.

TABLE III. PATIENTS SPIRITUAL NEEDS

<i>Patients Spiritual Needs</i>	<i>Number</i>	<i>Percentage (%)</i>
Good	57	62.6
Fair	33	36.3
Poor	1.1	1.1
Total	91	100

Table IV shows that the correlation between nurses' spiritual intelligence and meeting the spiritual needs of patients by nurses is said to be significant if the value of $p < 0.05$, in this study there was a relationship between spiritual intelligence and meeting the spiritual needs of patients by nurses in the wards of PKU Muhammadiyah Gamping Hospital ($p = 0.002 < 0.005$) while the connection strength is weak because the value is 0.314.

TABLE IV. 4. THE RELATION BETWEEN NURSES SPIRITUAL INTELLIGENCE AND PATIENTS SPIRITUAL NEEDS

<i>Method</i>	<i>P</i>	<i>R</i>
Spearman rho	0.002	0.314

IV. DISCUSSION

The results showed that the age range of respondents was 21-53 years old. This shows that nurses who work in the wards are in the adult age category. This research is in line with the research conducted by Asmuji [8] with the title Relationship between Nurse Characteristic Factors and Nurses' Performance in the Documentation of Nursing Care at the Inpatient Installation of Dr. H. Koesnadi Bondowoso hospital that vulnerable to nurse age is between 24-55 years. According to Riyadi [9], the age of nurses was closely related to the performance of nurses in providing nursing services, because the more mature the nurse's age, the more experience he had.

Nurses' education in this study had the most diploma education. This research is in line with the research of Ariyanti [10] with the title Relationship between Nurse Characteristics and Organizational Characteristics with Caring Behavior of Executing Nurses in Home wardss Kartika Husada Pontianak Hospital showed that most of the nurses who worked were Diploma with 93 (89.4%). Level education greatly influences a person's personality, with one's education will broaden insight, knowledge and skills so that they are able to face problems faced in their profession [11].

The percentage in this study shows more female nurses, 74.7% of male nurses as much as 25.3% in the inpatient ward of PKU Muhammadiyah Gamping Hospital. This research is

in line with the research conducted by Asmuji [8] that the population of female nurses was 71 more than male nurses as many as 35. Female nurses at generally have advantages compared to male nurses. The advantages lie in patience, thoroughness, responsiveness, gentleness, instincts of educating, caring, nurturing, serving, and guide who can minimize mistakes that are made so that they can cause differences in nurse competency itself [12]. Judging from gender, women are more likely to be diligent or diligent to carry out religious rituals that they believe in, such as religious places and other religious rituals [13].

Based on the results of the study it was found that the spiritual intelligence of nurses was included in the good category, this can be seen from the total sample of 91 respondents, 75 respondents (82.4%) from the total included in the good category, and 16 respondents (17.6%) including enough category. In line with the research conducted by Khotimah [14], show results that are on average the spiritual intelligence of nurses in the inpatient ward of Al Islam Bandung Hospital, from 97 nurses who were respondents there was an average score of 78.87 or near the highest value. This research is not in line with the research conducted by Anggriani [15] showed that 67.1% nurses had low spiritual intelligence and 32.9 nurses have high spiritual intelligence.

Influential age in shaping the level of knowledge of spiritual intelligence by nurses. This is reinforced by the statement Inayatullah [16] ages 18-40 years is a productive and creative early adulthood, where individuals have the mental ability to learn, adjust to new situations, such as remembering things that have been learned because there has not been a decline in memory, and is responsible for the burden given to him and apply the knowledge he has. In a study conducted by researchers in the PKU Hospital wards Muhammadiyah Gamping, the highest number of nurses is on average 29 years old.

Based on the results of the study showed that the fulfillment of the spiritual needs of patients by nurses to inpatients in PKU Muhammadiyah Gamping Hospital in good categories was 57 respondents (62.6%), enough as many as 33 respondents (36.3%) and bad as many as 1 respondent (1.1%). The results of this study are in accordance with the research conducted by Situmeang [17] with the title Knowledge, Attitudes and Actions of Nurses in Fulfilling Spiritual Needs in HIV Patients in RSUP H. Adam Malik Medan with the results that as many as 71.1% fulfillment of spiritual needs by nurses in good categories, 21.1% in the sufficient category and 7.9% in the bad category.

The first aspect that must be considered by nurses in meeting needs spiritual client is an increase in nurses' knowledge about the client's spiritual care and its benefits, because a person's positive or negative attitude towards an object is largely determined by the level of one's knowledge of the object's benefits [18]. Research on do by Archiliandi [19] obtain nurse results with a minimum Diploma's education can influence fulfillment of spiritual care needs be good, because at the stage Diploma's education is a level higher education, nurses with an education level will practice effective and efficient holistic nursing, with a good level of education will give a good contribution in nursing practice so that in the

advancement of the patient's spiritual needs can be maximally fulfilled.

As explained by Arini [20] in his research stated that the education level of Diploma is a higher education level. Nurses with good enough education will carry out effective and efficient nursing practices with a sufficient level of education that will contribute well in nursing practice so that in fulfilling the patient's spiritual care needs can be fulfilled. In a study conducted by researchers in the wards of PKU Muhammadiyah Gamping Hospital, the highest number of nurses was educated by Diploma.

Based on Spearman's rho test on two variables, namely the relationship between spiritual intelligence and the fulfillment of patients' spiritual needs with significance ($p = 0.002 < 0.05$) it means that there is a relationship between nurses' spiritual intelligence and meeting the spiritual needs of patients in PKU Muhammadiyah Gamping Hospital while the connection strength is weak because the value is 0.314. This is supported by Alaidin's [21] research with 90 nurse respondents in the RSJD Dr. Amino Gundhuto Semarang which shows the results that there is a relationship between the spiritual intelligence of nurses and meeting the spiritual needs of patients. This is also supported by research conducted by Emamgholian et al [22] showing that there is a relationship between the nurse's spiritual intelligence and competence in providing spiritual care with a correlation coefficient r of 0.23 with a significant level of $p = 0.001$. Different from research conducted by Wulandari (2016) states that there is no significant relationship between spiritual intelligence and fulfillment of spiritual needs by nurses.

Nurses who integrate professions with spirituality can make nurses better nurses. The influence of spirituality and spiritual intelligence used can enable nurses to solve their problems with a spiritual approach that can achieve well-being and self-actualization [23]. Meeting the patient's spiritual needs is one of the actions of nurses to meet holistic basic needs for patients [24]. Several factors can influence the practice of fulfilling spiritual needs patients include training and knowledge of spiritual nursing care, nurse's spiritual competence, perceptions of fulfilling the patient's spiritual needs as nurses' responsibilities, workloads and time spent by nurses [25].

In addition, other factors that can influence nurses to provide spiritual care to patients are nurses' awareness of spirituality, awareness of the existence of higher power, and the ability to search for meaning in life, where these components are part of spiritual intelligence [26]. The development of spiritual intelligence can increase spirituality and help a nurse provide spiritual care to patients [23]. Someone who is spiritually intelligent is not only intelligent in terms of knowledge, but also has a high level of awareness about spirituality, so that nurses can be more sensitive, reflective and responsive to their meanings and life experiences, and thus nurses tend to be easier to have a positive attitude towards providing spiritual care to patients [27].

ACKNOWLEDGMENT

The author would like to thank to nurses in PKU Muhammadiyah Yogyakarta for their participation in this study.

REFERENCES

- [1] Asmadi, N. Konsep dasar keperawatan. EGC. 2008.
- [2] Hubbell, S., et al. Spiritual care practices of nurse practitioners in federally designated nonmetro-politan areas of North Carolina. *Journal of the American Academy of Nurse Practitioners*, 18, 379385. 2006.
- [3] Wahab, A., & Umiarso. Kepemimpinan Pendidikan Dan Kecerdasan Spritual. Yogyakarta : Ar-Ruzz Media. 2011
- [4] Safaria, T. Spiritual intelligence: metode pengembangan kecerdasan spritual anak. Graha Ilmu. 2007.
- [5] Sukidi, I. Rahasia Sukses Hidup Bahagia, Kecerdasan Spritual. 2002.
- [6] Wahyuni, R., Mayangsari, M. D., & Fauzia, R. Hubungan Kecerdasan Spritual Dengan Perilaku Prososial Pada Perawat Di Rumah Sakit Islam Banjarmasin. *Jurnal Ecopsy*, 3(3). 2017.
- [7] Merianti, L., & Andhika, S. L. Kecerdasan Spritual Perawat Dalam Melaksanakan Kompetensi Perawat Melakukan Asuhan Spritual Kepada Pasien Rumah Sakit Islam Ibnu Sina Yarsi Padang Panjang Tahun 2015. *AFIYAH*, 3(1). 201
- [8] Asmuji, A., Faridah, F., & Handayani, L. T. Implementation of discharge planning in hospital inpatient room by nurses. *Jurnal Ners*, 13(1), 106-113. 2018.
- [9] Riyadi, T. G. S., Rahardjo, T. B., & Rumengan, G. Pengembangan Kebijakan Spritual Care Secara Menyeluruh dan Holistik Di Rumah Sakit Misi Lebak Banten. *Jurnal Bidang Ilmu Kesehatan*, 8(2), 16. 2018.
- [10] Ariyanti, S. Hubungan Karakteristik Perawat dan Karakteristik Organisasi dengan Perilaku Caring Perawat Pelaksana di Ruang Rawat Inap Rumah Sakit Kartika Husada Pontianak. *Jurnal Keperawatan Soedirman*, 12(3). 2017.
- [11] Vionita, V. G. Pengaruh Tingkat Pendidikan dan Motivasi Kerja terhadap Kinerja Pegawai Tata Usaha Smk Negeri di Kota Payakumbuh. *Jurnal Pendidikan Ekonomi*, 2(5). 2013.
- [12] Nursalam, & Efendi, N. F. Pendidikan dalam keperawatan. Jakarta: Salemba Medika. 2008.
- [13] Ramayulis. Pengantar psikologi agama. Jakarta: Kalam Mulia. 2002.
- [14] Khotimah SN. Hubungan kecerdasan spritual dengan otonomi profesional perawat di ruang rawat inap rumah sakit al islam bandung. Bandung: Fakultas Keperawatan Universitas Padjajaran. 2014.
- [15] Raya, N & Anggriani, N. Hubungan kecerdasan spritual dengan perilaku caring perawat pada praktik keperawatan di ruang rawat inap rumah sakit umum daerah. 201
- [16] Inayatullah, I., Isworo, A., & Kamaluddin, R. Hubungan Tingkat Pendidikan dengan Tingkat Pengetahuan Perawat tentang Asuhan Keperawatan dengan Pedoman NANDA NOC dan NIC di Rumah Sakit Umum Daerah Ajibarang. 2014.
- [17] Situmeang, D. M. Pengetahuan, Sikap dan Tindakan Perawat dalam Pemenuhan Kebutuhan Spritual pada Pasien HIV di RSUP. H. Adam Malik Medan. 2017.
- [18] Syaiful, Y., & Wibawa, S. Pengetahuan dan sikap perawat memenuhi kebutuahn spritual pasien kritis dengan implementasi keperawatan. *Journals of Ners Community*, 5(1), 29-35. 2014.
- [19] Archiliandi, A. Gambaran Pemenuhan Kebutuhan Spritual Care Oleh Perawat Kepada Pasien Rawat Inap RS PKU Muhammadiyah Bantul. 2016.
- [20] Arini, H. N., Susilowati, I., & Mulyono, W. A. Hubungan Spiritualitas Perawat Dan Kompetensi Asuhan Spritual. *Jurnal Keperawatan Soedirman*, 10(2), 130-140. 2015.
- [21] Alaidin, M. Hubungan Antara Kecerdasan Spritual Perawat Dengan Pemenuhan Kebutuhan Spritual Pasien Gangguan Jiwa di RSJD Dr. Amino Gundhuto Semarang. 2014.
- [22] Emamgholian, F., Hosseinabadi-Farahani, M. J., & Keshavarz, M.. The Relationship between Spiritual Intelligence and Competences in Providing Spiritual Care in Nursing Students. 2017.
- [23] Rani, A. A., Abidin, I., & Hamid, M. R. The impact of spiritual intelligence on work performance: Case studies in government hospitals of east coast of Malaysia. *The Macrotheme Review*, 2(3), 46-59. 2013. 2013.
- [24] McSherry, W., & Ross, L. Dilemmas of spiritual assessment: considerations for nursing practice. *Journal of advanced nursing*, 38(5), 479-488. 2002.
- [25] Wu, L. F., Tseng, H. C., & Liao, Y. C. Nurse education and willingness to provide spiritual care. *Nurse education today*, 38, 36-41. 201
- [26] Zohar, D., & Marshall, I. *SQ-Kecerdasan Spritual*. Mizan Pustaka. 2007.
- [27] Chiang, Y. C., Lee, H. C., Chu, T. L., Han, C. Y., & Hsiao, Y. C. The impact of nurses' spiritual health on their attitudes toward spiritual care, professional commitment, and caring. *Nursing outlook*, 64(3), 215-224. 2016.

Self Readiness of Women Who Were Married at Young Ages in Carrying Out A New Role After Being Married

Nur Azizah Indriastuti¹
 School of Nursing Medical
 Faculty and Health Sciences
 Universitas Muhammadiyah Yogyakarta
 Yogyakarta, Indonesia
 Email: azizah_indriastuti@yahoo.com

Rahmi Fahmawinda²
 School of Nursing Medical
 Faculty and Health Sciences
 Universitas Muhammadiyah Yogyakarta
 Yogyakarta, Indonesia
 Email: rahmifahmawinda@gmail.com

Abstract—*The marriage rate of women who get married at a young age in Indonesia is still high. The high rate of marriage at a young age can cause various problems in marriage, and this is due to the lack of preparation before women decide to get married. One of the readiness of women before deciding to get married is readiness in carrying out roles. More important role readiness is prepared by women because it deals with duties of wife which are more in the domestic sector such as doing household chores accompanying husbands and taking care of children. The purpose of this study is to describe the readiness of women who were married at a young age in carrying out new roles after marriage in Yogyakarta. This research uses qualitative method with phenomenology approach. Data collection is done with interview and observation. Participants totaling five people were determined by purposive sampling. The validity of the data used source triangulation and checked the data back to the participants. Analysis of data were by comparing among categories, marking and describing descriptively. The results show that not all participants have readiness to carry out new roles after marriage. There are things that prevent participants from carrying out roles.*

Keywords—*Readiness, Marriage, Women, Young Age, Roles*

INTRODUCTION

At present in Indonesia the number of women who get married at a young age is high. Data obtained from the Central Statistics Agency, the percentage rate of early marriage in Indonesia increased to 15.66% in 2018, compared to 2017 which was 14.18%. According to marriage data from the Ministry of Religion of the Republic of Indonesia, Bantul Regency of Yogyakarta, the number of married women at the age of 17-21 was 1,177 women in 2015, 1,111 women in 2016, and 440 women in mid-2017.

Marriage is a developmental task in early adulthood [5]. Marriage at a young age causes various problems in marriage due to the lack of readiness to get married to individuals who decide to marry at a relatively young age. According to the research results of Ghalili, Etemadi, Ahmadi, Fatehizadeh & Abedi [1], one aspect of marriage readiness is role readiness (a new role is appropriate to the role in married life). When a woman is married, she will have new responsibilities and duties that must be carried out according to her new role as a wife such as taking care of household chores sexual partners, and a mother that is to get

pregnant, give birth, and take care of children. If women do not have mature self-readiness in carrying out this role, it can cause psychological and emotional burdens [4]. Seen psychologically, the marriage of a young person has an impact that has the potential to become a trauma caused by the unpreparedness to carry out the tasks that arise after marriage, while this is not supported by the ability and maturity of oneself. In the aspect of emotional development, a person who gets marry at a young age does not yet have emotional maturity in resolving household conflicts resulting in negative emotions that result in unpleasant and troublesome situations while living in the household [16]. The purpose of this study is to describe the readiness of women who were married at a young age in carrying out new roles after marriage in Yogyakarta.

METHODS

This study used qualitative methods with a phenomenological approach. The study took place starting from February - March 2018. Participants in this study amounted to five women who were married at a young age determined by purposive sampling. Data retrieval was done by in-depth interviews and unstructured observation. The focus of observation will develop during the interview. The validity of the data was done using source triangulation, namely representatives of two husbands and one lecturer in the health department, as well as re-checking data with participants. Data analysis was done by comparing categories one category with the other marking in each unit, and describing descriptively about the essence of the phenomenon that has been obtained. The study was conducted in Tamantirto Village, Bantul Regency area of Yogyakarta. This research has passed the ethical test by the Medical faculty and health sciences Universitas Muhammadiyah Yogyakarta ethics committee with ethics number 042 / EP-FKIK-UMY / I / 2018.

RESULT

1. Characteristics of Participants

Tabel 1. Characteristics of Participants

Participants	Age	Education	Number of children
P1	20	Senior high school	-
P2	21	Senior high school	1
P3	21	Senior high school	-
P4	21	Senior high school	-
P5	20	Senior high school	1

First participant was 20 years old at the time of data collection and was 19 years old at the time of marriage. The age of the participant's husband was 27 years, and the condition was currently seven months pregnant. They are now pursuing their eighth semester undergraduate education at one of the private universities in Yogyakarta.

Second participant was 21 years old at the time of data collection and 19 years old at the time of marriage. The age of the participant's husband was 28 years old, the condition now they have one nine-month-old daughter. They are now pursuing a sixth semester undergraduate education at one of the private universities in Yogyakarta.

Third participant was 19 years old at the time of data collection and was 18 years old at the time of marriage. The age of the participant's husband was 21 years old, and the current condition they did not have children. They are now taking their second semester undergraduate education at one of the private universities in Yogyakarta.

Fourth participant was 21 years old at the time of data collection and 19 years old at the time of marriage the age of the participant's husband was 21 years old. She had a history of miscarriage and currently does not have children. They are now pursuing their eighth semester undergraduate education at one of the private universities in Yogyakarta.

Fifth participant was 20 years old when the data was taken and aged 19 when they were married. They have one 10-month-old boy. Participants are now pursuing their sixth semester undergraduate education at one of the private universities in Yogyakarta.

Self-readiness of women who get married at a young age to take on new roles after marriage

a. The new role that participants get after marriage

Married women will get a new role which is certainly accepted by participants in this study. The new role carried out by participants in this study is as wives and mothers. This is supported by quotations from the following interview:

- R1: "its role meets the needs of the husband"
- R2: " now I have two roles, namely as a wife and mother"
- R3: "wives should serve husbands"
- R4: "...but it turns out that being a wife is difficult, if it's not done with the heart ... first we have to take care of ourselves, husband, home, work, and all have to be handled"
- R5: "her role as a parent, her role as a wife serving a husband"

a. Special request from the participant's husband in caring for him

One of the roles carried out by the participant is as a wife that is serving a husband. Husbands also have special desires in how their wives serve and care for their husbands. This is supported by quotations from the following interview:

- R1: "my husband asked if he wanted to get it done when he was tired, if he asked to be accompanied he would be sure, ask him to be more frequent but I couldn't..."
- R2: "if my husband has come home from work, I have to be home soon. Sunday is usually the first time when there was an activity, now my husband does not ask much because it needs family day, gathering together, or at home"
- R3: "he often asked for massage, so I massage him when I was home"
- R4: "the habit is if he wants to do anything, I have to always accompany"
- R5: "husband doesn't demand too much....."

From this study it was found that there were participants' husbands who had special requests such as asking for massage from their wives, being served with home cook, always accompanying their husbands, or going home on time before their husbands arrived at home.

b. Things that prevent participants from carrying out roles

Participants while carrying out their roles also have barriers such as at present participants still have responsibility as students, this is in accordance with the quotations from the interview as follows:

- R2: "still in college too ..."
- R4: "even though my undergraduate thesis isn't finished ..."
- R5: "now it is in the sixth semester, and will repeat again in the fifth semester"

Meanwhile other obstacles were felt by participants in carrying out their role as wives because participants and husbands undergo long-distance relationship (LDR). Long distance relationships with their husband because they are separated by distance so that the intensity of meeting each other is getting smaller. This is supported by quotations from the following interview:

- R1: "I have LDR with my husband, so if you take care of your husband it is rare because it's far"
- R3: "now my husband and I are far apart"

c. The obligation of participants as wives to husbands

One of the roles of married women is to carry out their duties as wives to their husbands. The wife's obligations were stated by the participants are as follows:

R1: "prioritizing things related to my husband first"

R2: "ask for support and blessing from the husband"

R3: "if I already have a husband I can't go anywhere"

R4: "if I want to go out, I have to get permission from him"

R5: "now if you want to go somewhere you always get permission from your husband"

From this study it was found that participants said they always prioritized their interests, permission, or blessings. If the participants will go out, then the wives must ask permission from him first.

d. Work done by participants in the household

After marriage, participants are also responsible for taking care of household needs and chores. Some things that participants do in managing the household chores such as cleaning the house, cooking, washing clothes, washing dishes, ironing clothes, to managing family finances. This is supported by the interview quotations as follows:

R1: "clean and clean the room, wash my husband's clothes and clothes"

R2: "I've always been washing and ironing"

R3: "I used to do homework"

R4: "I have been able to cook, to wash clothes, and to manage finances"

R5: "I wash my husband's clothes and iron this early in marriage"

The results of source triangulation with the husband of participant four explain how the participants in taking care of the household are as follows: "Now my wife have begun to learn doing homework..."

e. The ability of participants to cook

One of the household chores done by participants is cooking. From the results of interviews, participants said that they were able to cook. This is supported by quotations from the following interview:

R2: "I often cook because my children must breakfast before going to school"

R3: "Alhamdulillah, I can cook ..."

R4: "I cook, if eating we must be together"

Participants who could not cook say that they still lacked confidence. Other participants also said they often bought side dishes outside the home rather than cooked at home. This is supported by quotations from the following interview:

R1: "if I'm cooking, I'm not confident because I'm afraid it won't taste good"

R5: "Every day just cooking rice (laughing)"

f. Open communication between participants and husbands

Participants also have a role as partner who can understand and communicate with their husbands. Participants said that they always opened communication like always sharing stories with their husbands. This is supported by quotations from the following interview:

R1: "I am very open with my husband"

R2: "I often discuss it with my husband"

R3: "I am always open with my husband, because if it is closed it will definitely be visible from body movements"

R4: "husband and wife must know each other"

R5: "I'm talking about it anyway (laughing) just say it. Very open,"

g. The way participants communicate with their husbands

The ways that the participants communicate with the husband are different. Participants have their own way of communicating according to the conditions of participants and husbands.

This is supported by quotations from the following interview:

R1: "phone or meet directly"

R2: "I ask all the little things"

R3: "I usually chat, call, video call, so every day"

R4: "by looking at his eyes"

R5: "husbands rarely take it seriously so if for example I want to talk seriously I must yell at him first"

The results of this study obtained several ways how participants communicate with their husband such as by meeting directly, always asking questions and telling stories, using a telephone or via social media because of the long distance, when talking had to look into his eyes, and yelling first because of the difficult nature of the husband of husband of the participant to be serious.

h. The way participants get closer to their parents-in-law

The next role is to recognize and to adapt to the family of the husband, especially the husband's parents. Participants say that the way to get closer to their parents-in-law is to consider them like their own parents. This is supported by quotations from the following interview:

R1: "I am with my parents-in-law and relaxed and just so cool, so I don't feel pressured, keep responding like my own mother"

R3: "my husband's family accepted me, instead he considered me as his own child. When I first met his family, I was worried, what should I do ... my mom said to be normal, if there is anything help "

R5: "I am very closed with my father-in-law who knows how close I am"

Other participants said that if they have feelings of anger at their parents-in-law, they were not directly shown before them. Participants are better informed to their husbands so that their husbands became intermediaries between participants and in-laws. This is supported by quotations from the following interview:

R2: "Alhamdulillah, my child is getting bigger and bigger, and this relationship with my father-in-law has grown more. How to improve my relationship with my father-in-law, in my Grandma's view, is by not immediately getting angry in front of my in-laws, just tell my husband then the husband becomes a fair mediator between his wife and mother, continue to pray and be patient"

Other participants said the way to get closer to in-laws is to communicate and to behave well. This is supported by the interview quotations as follows:

R4: "how to talk to in-laws don't fight, but it must be smooth ... for example you also buy snacks, you also have to buy for your in-laws".

I. Participation of participants in activities in the neighborhood

In addition to adapt to the family from the husband's side, participants also have a role to socialize with the community around the residence. The results of interviews with participants showed that only one participant who participated in community activities such as the gathering of mothers around the house. This is supported by quotations from the following interview:

R1: "if for the event for mothers in the surrounding environment I did not participate, because I was from high school the school was already far away, so I rarely gathered with the environment around the house"

R2: "for village events I was rarely invited because I was relatively new and rarely appeared ... I didn't get the invitation"

R3: "now because I'm still in college, so there is no one taking part in the events around the house..."

R4: "I currently don't participate if there are gatherings of mothers around the house like social gathering, then get together"

R5: "if the RT program for our service is taking part, PKK mother gatherings come along"

DISCUSSION

Readiness in carrying out new roles after marriage

Married women have a new role, namely as wives to meet the needs of husbands, mothers for their children, to take care of household needs, to become responsive community members and to be able to socialize with the surrounding community, and as workers if the woman also works [6].

In family life, each family member has the rights and obligations as well as their respective roles. A wife acts as

a housewife with the obligation to help her husband maintain a household, manage all household needs, pay attention to children's education, manage finance so that there is harmony between income and household needs [19].

a. New roles obtained by participants after marriage

The new role gained by participants after marriage is to become a wife and mother. The role that is conducted as a wife is to fulfill the needs and to serve the husband. Mother's role, starting from childbirth to take care of and caring of children. Subaidi, Sidiq, & Rahmawati [17] say that in a family, the husband acts as the head of the family and the breadwinner, while the wife is a housewife who is ready to serve her husband and children.

According to Lestari & Putri [7] it is said that the wife has a very important role in the family, namely as a companion of husband at all times and mother who are ready to take care and guide their children.

b. Things that prevent participants from carrying out roles

It is an obstacle for participants to be able to carry out their roles as wives and mothers maximally because participants are currently undertaking undergraduate education studies.

Participants also have responsibilities that must be done as students. Iklima [6] said that in the present, many women do not only carry out roles in the home, namely as wives or mothers, but they also have multiple roles such as working, continuing education, and being active in social movements. Women who have a dual role are required to be able to manage the time between work inside and outside the home.

It is an obstacle for participants in carrying out their role as a wife and mother, because now participants are undergoing a long-distance relationship with their husbands because participants must carry out their responsibilities as students, while the husbands of the participants are in a different city than the participant because he has to work. Prameswara & Sakti [14] said that long distance marriages are usually marked by the absence of a partner or the absence of physical attachment with a partner because it is difficult to meet each other. The intensity of meeting between husband and wife requires both parties to be independent of themselves.

b. Special request from the husbands of participants in caring for him

The husband of each participant has different background and character. There were husbands from participants who always asked to be massaged by the participants while at home. There was also a participant's husband asking participants to be at home before her husband returned home after work. Besides the husbands of the participants asked participants to always accompany their husbands when asked by their husbands and also have more time with family.

Islam teaches husbands and wives to have good morals with each other. Wives must show good morals to their husbands, namely obeying their obligations to fulfill their husbands' rights. According to the hadits, the moral demands of the wife towards the husband are fulfilling the

demands and needs of the husband. The wife is obliged to fulfill the demand and needs of the husband in accordance with the abilities possessed by the wife [9].

d. The obligation of participants as wives to husbands

The obligation of participants as wives to their husbands is to prioritize decisions made by their husbands as respect for their husbands. Participants said they always asked permission and blessings from their husbands when they would do something, and participants always asked permission from their husbands if they would leave the house and if the husband did not allow the participants would not leave the house. This is in accordance with what Nasution said [11] that wives must truly obey their husbands and even if they may bow down to other than Allah SWT, they will be ordered to prostrate to their husbands. The wife is obliged to ask permission from the husband if he goes out of the house, and the husband does not allow the wife, they cannot leave the house without the permission of the husband.

e. Work done by participants in the household

Participants say that the role is also carried out after marriage, namely taking care of the needs and doing household chores. The chores that can be done by the participants includes washing clothes, washing dishes, cleaning the house, arranging finances, cooking, and ironing clothes. Married women will have a dominant role in taking care of the household such as starting from shopping, cooking, washing, dressing up, managing finance, and giving birth, and caring for children. [19]. If women are married, they are expected to be able to take care of all matters related to housekeeping such as cooking, washing clothes, washing dishes, cleaning the house to caring for children [7].

f. The ability of participants to cook

Participants are able to cook because they are used to cooking before marriage. Participants have had independence since before marriage because they migrated and had to be independent including cooking by themselves. Participants said that they were used to and were used to cooking because participants felt cooking was an ability that women usually had. There are also participants who have not been able to cook because they still do not feel confident in the taste of the dishes that participants make. Participants who have not been able to cook choose to buy side dishes from outside the home. Subaidi, Sidiq, & Rahmawati [17] said that married women must be able to do homework, one of which is cooking, especially for families.

g. How to communicate with your husband

The way of communication carried out by participants with their husbands varies according to the conditions of the participants and the husbands. Participants use telephone and social media assistance such as chatting and video calls when participants are not close to their husbands. Participants said that they felt it was better to communicate face to face directly with their husbands. The way of communicating of the participants to their husbands when having face to face directly also varies according to the conditions of participants and husbands. Participants must

look directly at the husbands' eyes when communicating so that the husbands respond well to what the participants say. The way to communicate with the husbands is also adjusted to the character of the husbands who are difficult to take seriously and often jokes, so participants tend to shout at their husbands often before speaking seriously with their husbands.

One of the causes of misunderstanding between husband and wife is due to poor communication such as the way the husband communicates or vice versa. Every couple has their own way or strategy in communicating. Communication is sometimes blocked because the intensity of meetings between wife and husband is rare so that both parties are expected to maintain good communication and interaction [10].

One of the communication failures is the lack of empathy listening skills. The ability to listen to a couple's complaints becomes an important aspect in empathy communication. In young married couples the ability to hear is not possessed properly. This can be seen from the frequent pair angry with each other [8].

h. Open communication between participants and husbands

Participants said that communication made to husbands was open. Participants always tell stories, discuss, and ask anything to their husbands. Suraji [18] said that the family is a place for shelter, complaining, complaining, and even revealing the secrets that are owned, therefore it requires an open attitude of mutual trust, mutual reminder, and mutual forgiveness from each family member both husband, wife, and children.

In deliberation, the head of the family considers the opinions expressed by his wife and other family members and gives the wife an opportunity to express her opinion. The wife can also act as a partner or a pleasant partner to be invited to discuss about various kinds of problems both big and light things [7].

i. The way participants get closer to their parents-in-law

Every married individual automatically gets a new family group. They are family members of couples of different ages, ranging from babies to grandparents and sometimes with different backgrounds, different educational levels, different cultures and social backgrounds. Getting married means that someone will also often adapt to parents of a partner [13].

The way participants get closer to participants is to consider parents of husbands as their own parents so that participants feel comfortable and can be themselves when with their parents-in-law. Participants also said that they still need to maintain a good attitude when communicating or approaching in-laws. The role of the husband is also needed as an intermediary between participants and in-laws if there are things that are not liked by participants from their in-laws so that they do not directly offend their parents-in-law. Daughter-in-law will greet her in-laws as her own biological parents and dare to express what she feels to her parents-in-law because she is able to manage the environment according to her personal needs. For example, by assuming that your mother-in-law, like your own mother, can bring emotional closeness, so that you can feel

mutual understanding between your mother-in-law and daughter-in-law [15].

J. Participation of participants in activities in the neighborhood

From this study it was found that not all participants were active in participating in the activities of the local community or special activities of mothers in the neighborhood around the residence. The reason for the participants was because the participants were still in college so they did not take part in the activities around the neighborhood. Participants also still feel new in the new place of residence so they are still not invited directly by the community to participate in community activities around the house. Iklima [6] that in addition to women being responsible for carrying out roles in the home as wives and mothers, married women should have a role for responsiveness and response to the community in the surrounding neighborhood.

ACKNOWLEDGMENT

The authors thank to all respondent who participating and giving information for accomplish research data.

REFERENCES

- [1] Abedi, M. R., Ahmadi, S. A., Etemadi, O., Fatehizadeh, M., & Ghalili, Z. (2012). Marriage readiness criteria among young adults of Isfahan: A qualitative study. *Interdisciplinary Journal of Contemporary Research in Business*.
- [2] Daniel, M. I. (2016). Early marriage of young and adolescent girls: Causes and impact on children and society. Cofounder/Trustee, Unified Initiative for a Drug-Free Nigeria (UIFDN).
- [3] Hurlock, E.B. (1999). *Psikologi Perkembangan: Suatu Pendekatan Sepanjang Rentang Kehidupan*. Alih bahasa: Istiwidayati & Soedjarwo. Edisi Kelima. Jakarta: Erlangga
- [4] Iklima. (2014). Peran wanita karir dalam melaksanakan fungsi keluarga (studi kasus PNS wanita yang telah berkeluarga di balai kota bagian HUMAS dan protokol Samarinda). *Journal Ilmu Sosiatri*, Volume 2, Nomor 3, 77-89.
- [5] Lestari, S., & Putri, D. P. (2015). Pembagian peran dalam rumah tangga pada pasangan suami istri jawa. *Jurnal Penelitian Humaniora*, Vol. 16, No. 1, 72-85
- [6] Masturi, A. (2010). Membangun relasi sosial melalui komunikasi empatik. *Jurnal Dakwah dan Komunikasi*, IV, 14-31
- [7] Maulida, A. (2014). Kurikulum pendidikan akhlak keluarga dan masyarakat dalam hadits Nabawi. *Jurnal Pendidikan Islam* Vol. 03.
- [8] Najoan, H. J. (2015). Pola komunikasi suami istri dalam menjaga keharmonisan keluarga di desa Tondegesan II kecamatan Kawangkoan kabupaten Minahasa. *Journal "Acta Diurna"* Volume IV. No.4
- [9] Nasution, M. S. (2015). Perspektif filsafat hukum islam atas hak dan kewajiban suami istri dalam perkawinan. *Jurnal Studi Keislaman*, Volume 15, Nomor 1, 63-80.
- [10] Octavia, D. (2014). Penyesuaian diri pada remaja putri yang menikah muda. *Journal Psikologi*, 116-122
- [11] Prameswara, A. D., & Sakti, H. (2016). Studi kualitatif fenomenologis pada istri yang menjalani pernikahan jarak jauh. *Jurnal Empati*, 417-423.
- [12] Rini, D. P., & Lestari, R. (2017). *Subjective well-being pada menantu perempuan yang tinggal dengan ibu mertua*. Prosiding SEMNAS Penguatan Individu di Era Revolusi Informasi.
- [13] Setyawan, Jefri., Marita, Hasna Rizka., Kharin, Ismi & Jannah, Miftakhul. (2016). Dampak Psikologis pada Perkawinan Remaja di Jawa Timur. *Jurnal Penelitian Psikologi*. Vol 07. No 02. 15-39
- [14] Subaidi, Sidiq, M., & Rahmawati, A. (2015). Peran istri pelayanan dalam pemenuhan kebutuhan keluarga. *Jurnal Ilmu Kesejahteraan Sosial* Universitas Jember, 1-16.
- [15] Suraji, I. (2013). *Akhlaq dalam kehidupan berkeluarga*. Jurusan Stabiyah STAIN Pekalongan.
- [16] Tumengkol, S. M., Tasik, F. C., & Tumbage, S. M. (2017). Peran ganda ibu rumah tangga dalam meningkatkan kesejahteraan keluarga di Desa Allude Kecamatan Kolongan Kabupaten Talaud. *Jurnal Acta Diurna*, Volume VI. No. 2.

TECHNOLOGY, ENGINEERING, AND AGRICULTURE

Strengthening of Reinforced Concrete Slabs using Cold Formed Steel

1st Alamsyah

Department of Civil Engineering
Politeknik Negeri Bengkalis
Bengkalis, Indonesia
alamsyah@polbeng.ac.id

2nd Indriyani Puluhalawa

Department of Civil Engineering
Politeknik Negeri Bengkalis
Bengkalis, Indonesia
indriyani_p@polbeng.ac.id

Abstract—Low quality control in concrete work often causes a decrease in the quality of compressive strength. The effect of that, the function of the structure was not achieved as planned. There have been many studies aimed at increasing the strength of structures using CFRP, GFRP, Steel plates, steel wires, etc. This paper presents the results of the behavior of concrete slabs with cold formed steel as strengthening. Cold formed steel that easily obtained, has a high tensile strength and low prices was the ideal option for strengthening materials, particularly in flexural structures. The specimen test that has been made was the normal concrete slab (NS) and concrete slab with additional channel shape cold formed steel (SS). The test results showed an increase in stiffness and peak load on the SS specimen. On the other hand, there was no significant difference load when the first crack on the SS or NS specimens. The crack pattern that occurs in NS and SS was not much different and was still a flexural crack categories, and this was as expected that the addition of cold formed steel area considering the slab structure will not shear failure.

Keywords- Channel shape; cold formed steel; flexural strength; strengthening

I. INTRODUCTION

One reason for the low quality of concrete has been caused by the low quality of supervisors. This causes the function of the concrete structure that has been constructed will not meet the requirements as planned. For example, the floor slab originally planned as a library could not be realized because the concrete slab test results were much lower than they should be. So it is necessary to do special treatment on the slab, one of them is by strengthening. The strengthening of flexural structure that has been studied is using CFRP, and the result showed that the slab with CFRP sheets occur enhances the capacity, ductility and toughness (Fathelbab, 2014). The other materials have also been used for strengthened was GFRP that also showed better result for strength and stiffness compared to normal slab (Ali, 2016 and Tank, 2017).

Beside the materials that are already popularly used as strengthening, there are also other materials that can be utilized such as the addition of steel reinforcement or steel wires as has been studied by Hartono (2010) and Puluhalawa (2015).

After studying the research carried out using cold formed steel for flexural structure and providing the effective results for bending structures (Tan, 2015). This was interesting to use cold formed steel for strengthened material on the slab concrete. Cold formed steel that known as light steel has been high tension of strength, available in the market and easier to application in the existing concrete slab. It is expected that with

the use of cold formed steel, strengthening structural elements are not expensive and not hard to do because can be application by workers in general.

The specimens that has been made are a normal concrete slab (NS) and a strengthening concrete slab with the addition of channel shape cold formed steel (SS). Analysis of slab reinforcement and the addition of cold formed steel as strengthening have considered that the slab will not shear failure. The theoretical analysis uses the Response2000 software and compares with the experimental laboratory that used one point static load in the middle span of the slab. Furthermore, to avoid shears failure in the web of cold formed steel, the number of dinabolt installed has considered the amount of shear force.

II. LITERATURE REVIEW

The strengthening of existing concrete structures to resist higher design loads, correct strength loss due to deterioration, correct design or construction deficiencies, or increase ductility has traditionally been accomplished using conventional materials and construction techniques, ACI (2008). The difference with reinforced concrete slab in general is the addition of tension by cold formed steel (T_{cfs}) at the bottom side as in Fig. 1.

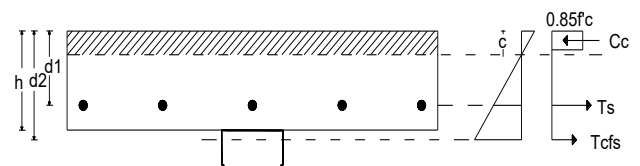

Fig. 1. Internal Strain and Stress Distribution for Strengthened Concrete Slab

This paper was comparing experimental test with analytic calculations stress block, in this case using the Response2000. Response-2000 is a program that able to calculate the strength of traditional beams, slabs and columns as well as or better than existing methods. There is no choice to make a cold formed steel model on the Response2000, so modeling was made by adding the area of cold formed steel on the bottom side of the slab.

The properties of cold formed steel and dynabolt refer to the test data of PT. NS BlueScope Lysaght Indonesia (2017). As for the data are:

- a. Cold formed steel mechanical properties
 - Minimum yield strength : 550 MPa
 - Modulus of Elasticity : 2.1×10^5 MPa
 - Shear Modulus : 8×10^4 MPa
- b. Protective coating
 - Aluminium (Al) : 55%
 - Seng (Zinc) : 43.5%
 - Silicon (Si) : 1.5%
 - coating thickness : 100 gr/m²
- c. Anchor bolt/ Dynabolt (Diameter 12 mm)
 - Shear : 5.2 kN
 - Tensile : 2.0 kN

III. METHODOLOGY

A. Material

The materials that have been used generally are projects on Bengkalis Island such as fine and coarse aggregate from Tanjung Balai Karimun. The results of the test properties are in the following Table I and Table II.

TABLE I. TEST OF FINE AGGREGATE

No	Test	Result
1	Zone	II
2	Water content	5.93%
3	Bulk specific gravity on SSD Basic	2.585
4	Water absorption	1.14%
5	Fineness Modulus	2.384

TABLE II. TEST OF COARSE AGGREGATE

No	Test	Result
1	Grading	Max. 20 mm
2	Water content	0.32%
3	Bulk specific gravity on SSD Basic	2.55
4	Water absorption	0.65%
5	Fineness Modulus	6.67

The longitudinal reinforcement that has been used was the 10 mm of diameter that has the Indonesia standard. Tensile test results as shown in the Table III.

TABLE III. TENSILE TEST OF STEEL Ø10 MM

Sample	Max. Load (N)	Yield Load (N)	fu (MPa)	fy (MPa)
Steel 1	42928.74	28871.82	546.58	367.60
Steel 2	43172.35	29283.31	549.68	372.84
Average				370.22

The strengthened slab has used cold formed steel C shape with a shear connector of dynabolt. The properties data of material has been described previously.



Fig. 2. Cold formed steel C75.65 and Dynabolt

Furthermore, the composition of the concrete mixture refers to the existing regulations with the results in Table IV.

TABLE IV. MIX DESIGN COMPOSITION, K225

Water (kg/m ³)	Portland composite cement (kg/m ³)	Fine Aggregate (kg/m ³)	Coarse Aggregate (kg/m ³)
215	371	698	1047

Source: Permen PUPR28-2016

B. Specimens

In this study two kinds of slab concrete specimens were made with dimensions of 1500 mm length, 450 mm width and 100 mm thickness. In addition, cylindrical specimens have also been made to determine the compressive strength of concrete. Detail of area reinforcement, strengthened and the result of compressive strength as shown in Table V and Fig. 3.

TABLE V. DETAIL OF SPECIMENS

Specimen	Longitudinal bars (mm ²)	Added area of Strengthened (mm ²)	Dynabolt (pcs)	fc (MPa)
NS	392.69	non	non	17.47
SS	392.69	100.36	8	17.47



Fig. 3. Normal and Strengthened Slab

C. Set-up test

Set-up of the test object with one point load in the middle of the span as shown in Fig. 4.

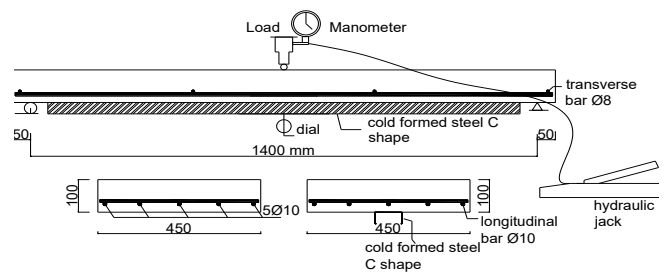

Fig. 4. Detail of slab and Set-up of test

IV. RESULT AND ANALYSIS

The experimental result of the normal slab (NS) and strengthened slab (SS) are presented in Table VI. The strengthened slab has been increase the load and stiffness compared to normal Slab with 15.38% and 6.05% respectively at peak load conditions. This was the same as the study using CFRP and GFRP which showed an increase in maximum load on strengthened specimens compared to normal slab (Rehman, 2018). Moreover, increased stiffness has also occurred in the slabs using strengthened using carbon fiber laminates and steel plates (Zheng, 2019).

TABLE VI. SUMMARY OF SPECIMENS TEST RESULT

Slab Specimen	Peak load (kN)	Deflection in mid-span (mm)	Stiffness (kN/mm)	Failure mode
NS	32.5	10.35	3.14	Flexural cracks
SS	37.5	11.27	3.33	Flexural cracks

Further, the result of comparison between the experiments and the theoretical analysis of all specimens are shown in Table VII and Fig. 5. Since the start of loading test, there was no significant difference between NS and SS, but when the load was above 20 kN, SS specimen was still able to accept the greater load up to peak loads.

On the other hand, a comparison of laboratory tests and theoretical results shows that the normal slab (NS) has a greater load difference of 12.06% for theoretical loads. But for SS it has a smaller difference of 10.71% of the theoretical load. This can be caused by the modeling of cold formed steel that cannot be perfect in the Response2000 but only models the addition of area on the bottom side of the slab. Overall, the theoretical stiffness was greater than laboratory tests, both on NS and SS.

TABLE VII. MOMENT COMPARISON BETWEEN EXPERIMENTAL AND ANALYTIC

Slab Specimen	Peak load (kN)	Moment capacity, M_u (kNm)	Predicted load (kN)	Predicted moment, M_R (kNm)	M_u/M_R
	Experimental		Analytic by Response2000		
NS	32.5	11.38	29	10.15	1.12
SS	37.5	13.13	42	14.70	0.89

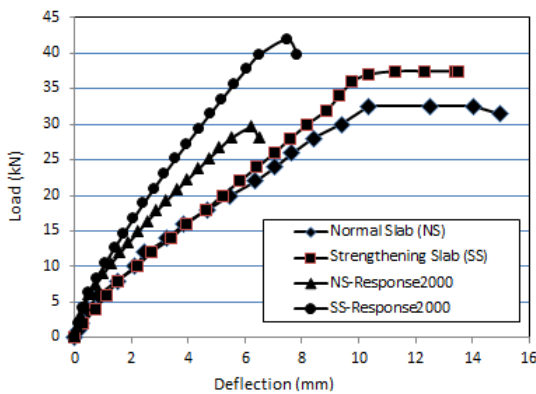

Fig. 5. Load-deflection experimental and theoretical

The difference of crack patterns between Response2000 models and laboratory tests has shown in Fig. 6. If viewed in number, the SS crack pattern was more than the NS, and its position was also closer to the support. This has also happened to modeling and experimental. However, the whole test specimen shows a flexural crack pattern as planned to not shear failure. This result was effective compared to slab strengthened using steel wires that debonding failure (Puluhulawa, 2015).

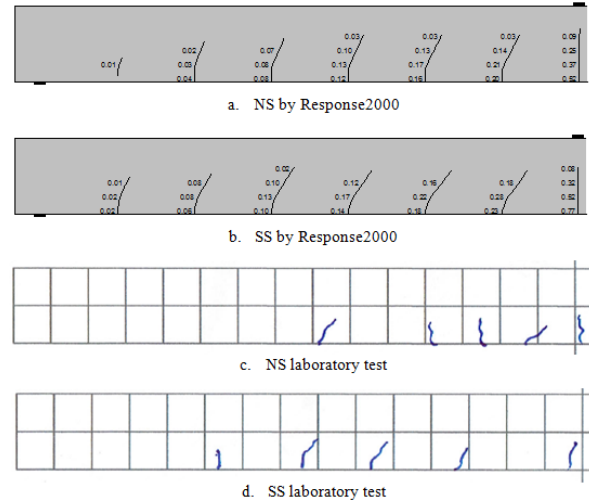

Fig. 6. Crack pattern (half of span)

V. CONCLUSION AND RECOMMENDATION

From the test results it has been concluded that the addition of cold formed steel was easily carried out by work in general because it only attaches cold formed steel to the bottom side of the slab and put the dynabolts as a shear connector. Moreover, the addition of 0.65 mm thick C75 cold formed steel on the bottom side of the slab has been able to increase the flexural strength and stiffness of the slabs. For further research, it is necessary to add a larger area of cold formed steel and keep in mind that the specimens will fail flexural and then make a variety of shear connectors and also use software that can be better in the modeling.

ACKNOWLEDGMENT

The publication of this paper cannot be separated from the contribution of the material testing laboratory and Bengkalis State Polytechnic Research Center.

REFERENCES

ACI (American Concrete Institute). (2008). Guide for the design and construction of externally bonded FRP systems for strengthening concrete structures. ACI 440, Farmington Hills, MI

Ali, T; Yehia, S. (2016). Study on Strengthening of RC Slabs with Different Innovative Techniques. *Open Journal of Civil Engineering*, (6), 516-525.

Anonim. (2016). Pedoman Analisa Harga Satuan Pekerjaan Bidang Pekerjaan Umum. PERMEN PUPR. Jakarta

- Fathelbab, F. A.; Ramadan, M. S.; Al-Tantawy, A. (2014). Strengthening of RC bridge slabs using CFRP sheets. *Alexandria Engineering Journal*, 53 (4), 843-854.
- Hartono, J., Satyarno, I., Triwiyono, A. (2010). Flexural Strengthening of Rectangular Concrete Slab using Tension Reinforcement and Composite Mortar. *Jurnal Ilmiah Semesta Teknika*, 13 (1), 1-11.
- Puluhulawa, I. (2015). Flexural Capacity of Strengthening Reinforced Concrete Plates Using Steel Wires and Mortar. *Jurnal Inovtek*, 5 (1), 61-68.
- Rehman, M.A.; Dhoke, S.V.; Shirbhate, S.R. (2018). Experimental Study on Strengthening of RCC by using CFRP and GFRP Sheets. *International Journal of Engineering Development and Research*, (6), 60-68
- Tank, T.; Modhera, C.D. (2017). Finite Element Modelling of RC Slab Strengthened with GFRP. *Material Today: Proceedings*, 4 (9), 9748-9791.
- Tan, C.S; Lee, Y.L; Mohammad, S; Lim, S.K; Lee, Y.H; Lim, J.H. (2015). Flexural Behaviour of Reinforced Slab Panel System with Embedded Cold Formed Steel Frames as Reinforcement. *Jurnal Teknologi (Sciences & Engineering)*, 74 (4), 39-44.
- PT NS BlueScope Lysaght Indonesia. (2017). Spesifikasi Rangka Atap Baja Ringan Sistem Smartruss® Classic. Retrieved March, 4, 2019 from <http://kji-kbgi-2017.polinema.ac.id/file/kji/Spesifikasi%20Smartruss%20Classic%20-%20Canai%20Dingin.pdf>
- Zheng, X; Wan, B; Huang, P; Huang, J. (2019). Experimental Study of Hybrid Strengthening Technique using Carbon Fiber Laminates and Steel Plates for Reinforced Concrete Slabs. *Construction and Building Materials*, (210), 324-327

Analysis of The Type of Dominant Damage at The Drainage Pump (Case Study: Surabaya City Pump Station)

1st Andi Candra Septaprasetya
Civil Engineering Department, Faculty
of Civil, Environmental & Geo
Engineering
Institut Teknologi Sepuluh Nopember
(ITS)
Surabaya, Indonesia
bearelits42@gmail.com

2nd Umboro Lasminto
Civil Engineering Department, Faculty
of Civil, Environmental & Geo
Engineering
Institut Teknologi Sepuluh Nopember
(ITS)
Surabaya, Indonesia
umboro.lasminto@gmail.com

3rd Vita Ratnasari
Statistics Department, Faculty of
Mathematics, Computation, and Data
Science
Institut Teknologi Sepuluh Nopember
(ITS)
Surabaya, Indonesia
vitaratnasari@gmail.com

Abstract— *Most of Surabaya area is lowland, which is 80.72% with an altitude between 3-8 meter above sea level, with a slope of less than 3%. Therefore, the city drainage system requires pump station operations to drain rainwater. One of the factors that can hinder the performance of pump stations in flood management is the damage to the drainage pump unit. This study has succeeded in finding motor damage as the type of dominant damage at drainage pump in Surabaya. The analysis of the types of dominant damage using the Analytical Hierarchy Process (AHP) by determining the type of dominant damage as the objective in the first level hierarchy, the dominant damage criteria are at the second level, and the types of damage are at the third level as an alternative decision. The types of damage are obtained by processing historical-data of pump damage in 2017 to 2018, while the criteria for determining the dominant kind of damage and the assessment in the AHP analysis are obtained from interviews and questionnaire with experts from the Surabaya city government and pump companies. The results of this study can be used to find the dominant causes of damage and forms of mitigation.*

Keywords— *AHP, Dominant Damage Type, Drainage, Multi-Criteria Decision, Pump Station*

I. INTRODUCTION

Surabaya as one of the big cities in Indonesia is located on lowland area, which is 80.72% with an altitude between 3-8 meter above sea level with a slope of less than 3% (BPS-Statistic of Surabaya Municipality, 2018). Surabaya has a high population density and narrow open space that can be used for water absorption. All conditions above are the basis for the need for a decent and effective city drainage system and supported by proper drainage facilities and infrastructure such as pump station as a form of anticipation of the flood hazards in the city of Surabaya when the rainy season arrives. The role of the pump station is very strategic for flood prevention in the Surabaya City drainage system. Pump station performance will significantly affect the performance of the overall drainage system in its efforts for flood management. This effort requires that the pump station and all the facilities inside can optimally operate whenever needed, especially in the rainy season.

One of the factors that can hinder pump station performance is the damage to the drainage pump unit. The

damage can reduce the workflow of the pump station as a whole in flowing water in the channel so that the pump station's performance decreases, this will be very detrimental and can cause inundation or overflow on the channel. Especially if there is very high rainfall and the water level condition on the channel at the side of the pump inlet is high, while it is not possible to drain water gravitationally due to the low channel slope or the tide of sea water. Efforts to minimize the occurrence of damage can be made by mitigating the factors that cause damage. By finding the dominant type of damage with various criteria, it is expected that the mitigation efforts carried out can be targeted and have a significant influence in reducing the incidence of damage to the drainage pump.

From the explanation above, study or research to identify the types of dominant damage that occur in the drainage pump at the Surabaya pump station is necessary to be conducted. This study will show how multi-criteria decision analysis can be used to solve problems related to efforts to reduce the damage incidence of drainage pump damage. The results of the study can be used as a basis for determining preventive policies for local government in reducing the rate of damage to the drainage pump.

II. LITERATURE REVIEW

A. Drainage Pump

A pump is a device that emits energy to raise, transport, or compress liquids (Encyclopedia Britannica). According to Fox and McDonald (1994), machines that add energy to the fluid by doing business/work on it are called pumps if the flow is liquid or slurry, and the fan, blower, or compressor, depending on the increase in pressure for gas or steam. The fan usually has a small pressure increase (less than 1 inch of water) and the blower has a moderate pressure (maybe 1 inch of mercury); pumps and compressors have very high rising pressure. Industrial system flow operates at pressures up to 150.000 psi (104 atmospheres). The type of pump commonly used in drainage systems is a type of centrifugal pump. The following are the fundamental components that are generally present in the centrifugal (electric) pump, added motor, which is inseparable from the pump system :

1. Motor
2. Chasing
3. Impeller
4. An assembly of mechanical components that makes it possible for the impeller to be rotated within the pump casing (shaft and bearing)

Some study related to damage to the drainage pump had been done by some researcher. Korving et al. studied the statistical modeling of the serviceability of the sewage pump (Korving, 2006). Tulleken has Identified and categorized problems that occur at sewage pump stations on his thesis (Tulleken, 2012).

B. Surabaya Pump Stations

Pump stations are one of the drainage facilities, complementary buildings, which are buildings that help regulate and control rainwater flow systems to be safe and smoothly pass through the canal. Inside the pump station there are several components/ supporting devices; submersible pump type flood pump, sludge pump type mud pump, submersible pump type electrical panel, sludge pump type electrical panel, column pipe and exhaust pipe, generator set, transformer, incoming and outgoing cubicle, Watergate, bar screen and pump station building.

To deal with flood problems in the city of Surabaya, the city government has carried out structuring and upgrading of urban drainage systems that refer to the Surabaya City Drainage Master Plan of 2000. In the Drainage Master Plan, the Surabaya City drainage system is divided into 5 (five) areas, Genteng, Gubeng, Jambangan, Wiyung, and Tandes. The total area was approximately 36396.46 Ha.

Based on the history of the development of urban drainage in Surabaya, some of the channels that were previously designed for the provision of irrigation are now switching functions as drainage channels along with the rapid growth of the built area. In the transition of irrigation channel functions into drainage channels, it requires a lot of repairs and excavations at lower elevations. The principle of construction of the drainage channel is different from the principle of irrigation channel construction, which generally narrows downstream. The efforts that have been made by the Surabaya City Government are to turn irrigation canals into drainage channels and to place pump stations on these channels. Until now, Surabaya City has 54 pump stations spread throughout the city. These pump stations are used to help drain rainwater, which cannot flow smoothly due to the low slope of the channel. Meanwhile, to protect low-lying coastal areas during the highest tides and prevent back water from occurring, dams and sea gates are built on the primary canal.

C. Multi-Criteria Decision Analysis

The Analytic Hierarchy Process (AHP) was developed first by Saaty (1980). Since then, some related study about the application of multi-criteria decision using the Analytic Hierarchy Process (AHP) had been done by some researcher. Saaty in 2008 introduced the decision making with the analytic hierarchy process (Saaty, 2008). Maletic et al. studied the application of the analytic hierarchy process (AHP) for the evaluation/ selection of maintenance policy (Maletic, 2014). Yudiono studied the implementation of the analytic hierarchy process (AHP) to analyze the selection of primary electrical power resources for pump station (Yudiono, 2018).

Aminbakhsh et al. studied risk assessment using the analytic hierarchy process (AHP) during the planning and budgeting of construction projects (Aminbakhsh, 2013). Andriani et al. determined the most frequent (dominant) land subsidence impact using the analytic hierarchy process (AHP) (Andriani, 2018).

III. METHODOLOGY

This study began with the identification of the type of damage to the drainage pump and continued with determining the criteria for determining the kind of dominant damage in the drainage pump. The multi-criteria analysis of the types of dominant damage will use the Analytical Hierarchy Process (AHP) by determining the type of dominant damage at drainage pump as the objective in the first level hierarchy, the dominant damage criteria are at the second level, and the types of damage are at the third level as an alternative decision.

A. Damage Type Identification

The types of damage are obtained by processing and grouping historical data of pump damage at Surabaya Public Works Agency.

B. Determining the Criteria

The criteria for determining the dominant type of damage are obtained through literature study and interviews with experts from the Surabaya city government and pump companies.

C. Analytical Hierarchy Process

According to Saaty (2008), decisions involve intangibles that need to be traded off. To do that, they have to be measured alongside tangibles whose measurements must be evaluated too, how well they serve the objectives of the decision maker. AHP is a method for solving unstructured and complicated problems that may have correlations and interactions among different objectives and goals. The Analytic Hierarchy Process (AHP) is a theory of measurement through pairwise comparisons and relies on the judgments of experts to obtain priority scales. To make a decision systematically and to generate priorities, we need to decompose the decision into the following steps.

1. Define the problem and the kind of knowledge sought.
2. Structure the decision hierarchy from the top level, the decision goal, then the objectives from a broad perspective, through the intermediate levels (criteria on which subsequent elements depend) to the lowest level (which usually is a set of the decision alternatives).
3. Construct a set of pairwise comparison matrices. Each element in an upper level is used to compare the elements in the level immediately below concerning it.
4. Use the priorities achieved from the comparisons to weigh the priorities in the level immediately below. Do this for every element. Then for each component in the level below add its weighed values and obtain its overall priority. Continue these actions of weighing and adding until the final priorities of the alternatives in the bottom-most level are achieved.

To make comparisons, we need a scale of numbers that indicates how many times more important or dominant one element is over another element with respect to the criterion or property with respect to which they are compared.

Saaty (1980) has shown that to maintain reasonable consistency when deriving priorities from paired comparisons, the number of factors being considered must be less or equal to nine. AHP allows inconsistency but provides a measure of the inconsistency in each set of judgments. The consistency of the judgmental matrix can be determined by a measure called the consistency ratio (CR), defined as:

$$CR = \frac{CI}{RI} \tag{1}$$

Where CI is called the consistency index, and RI is the Random Index. Furthermore, Saaty (1980, 2000) provided the average consistencies (RI values) of randomly generated matrices (table 2). CI for a matrix of order n is defined as:

$$CI = \frac{\lambda \max - n}{n-1} \tag{2}$$

In general, a consistency ratio of 0.1 or less is considered acceptable; this threshold is 0.08 for matrices of size four and 1.11 for matrices of size five.

TABLE I. THE FUNDAMENTAL SCALE OF ABSOLUTE NUMBERS (Saaty 1980)

Intensity of Importance	Definition	Explanation
1	Equal Importance	Two activities contribute equally to the objective
2	Weak or slight	Experience and judgment slightly favor one activity over another
3	Moderate importance	
4	Moderate plus	
5	Strong importance	Experience and judgment strongly favor one activity over another
6	Strong plus	An activity is favored very strongly over another; its dominance showed in practice
7	Very strong or demonstrated importance	
8	Very, very strong	
9	Extreme importance	The evidence favoring one activity over another is of the highest possible order of affirmation
Reciprocals of above	If activity i has one of the above non-zero numbers assigned to it when compared with activity j, then j has the reciprocal value when compared with i	A reasonable assumption
1.1–1.9	If the activities are very close	May be difficult to assign the best value but when compared with other contrasting activities the size of the small numbers would not be too noticeable, yet they can still indicate the relative importance of the events.

TABLE II. THE AVERAGE CONSISTENCIES OF RANDOM MATRICES (RI VALUES) (Saaty 1980)

Size	1	2	3	4	5	6	7	8	9	10
RI	0.00	0.00	0.52	0.89	1.11	1.25	1.35	1.40	1.45	1.49

Pairwise comparison analysis used an expert choice application to simplify the pairwise comparison matrix calculation. The assessment in the AHP analysis is obtained from interviews and questionnaire with experts from the Surabaya city government and pump companies.

IV. RESULT AND ANALYSIS

A. Damage Type

Based on historical data on damage to the drainage pump at the Surabaya pumping house, various damages can be grouped into types of damage based on the grouping of the drainage pump parts added electrical panel part which is inseparable from pump system on pump station, as follows:

TABLE III. DAMAGE TYPE CLASSIFICATION AND GROUPING

Damage on Drainage Pump	Damage Type Grouping
Damp motor coil	Motor damage
Burnt motor coil	
Cable band leaked out	
Wear out cover section	Chasing damage
Cracked cover section	
Cracked Impeller	Impeller damage
Disposition impeller blade	
Wear out the shaft-impeller spindle	
Eroded impeller blade	
Bearing position is not center	Shaft and bearing damage
Bearing tolerance is too loose	
Fracture shaft	
Wear out shaft	
Defective sensor	
Snaped censor cable	
Wear out the mechanical seal	
Fracture mechanical seal	
Seal leakage	
Panel part damage due to foreign object interference	
Panel part damage due to overload	
Panel part damage due to exceeding the part lifetime	
Busted cable	
Cable shoe corrosion	
Defective shift starter card	
Burn out contactor	
Breaker damage	

Source: Author-data compilation (2017-2018)

B. Criteria for Determining The Dominant Type of Damage

The literature studies and interviews with the experts from the Surabaya city government and pump companies result in us 5 (five) criteria that can determine the dominant level of each damage type, as follows :

a) Repair cost

The budget is the primary variable in determining operational and maintenance policies at the Surabaya City Public Works Agency. In terms of the cost of repairs, from the types of damage mentioned above, there is a type of damage that stands out or is considered more dominant because it requires relatively high maintenance and some are considered not because the cost of repairs needed is relatively low. Therefore, the cost of repairs can be used as a criterion to determine the type of damage that is dominant.

b) Frequency of damage

In a year, damage to the drainage pump can reach more than 100 damage incidents. Several types of damage are prominent or dominant because of the frequency of occurrence is relatively high, and there are also types of damage that are rare. Therefore, the frequency of damage can be used as a criterion to determine the kind of damage that is dominant.

c) The time length of repair

From the types of damage above, there is a type of damage that requires a long handling time related to the supply of spare parts and techniques or methods of repair, and there is a type of damage that only requires a short time to handle. Based on the handling period, a kind of damage can also be said to be more dominant than others because of the more prolonged handling. Therefore, the time length of repair or the period of handling can be used as a criterion to determine the type of damage that is dominant.

d) Complexity

The level of complexity of handling damage to the drainage pump varies according to the part that is damaged. Damage sometimes requires special handling to require an overhaul, while other types of damage are only enough to replace the damaged section with new parts without having to lift the drainage pump (such as damage to the breaker on the panel). Based on the complexity or level of complexity, damage can be said to be more dominant than others because it feels the level of complexity is higher because it requires particular spare parts, specific repair methods that have a high degree of difficulty and require experts to process it.

e) Impact on the system

Each type of damage has a different impact on the pump system as a whole. Certain types of damage, besides being able to cause the pump as a whole to stop operating, can also cause damage to the other parts of the pump. Meanwhile, the different types of damage, the damage is local, meaning it has no effect and causes damage to other parts and the pump system as a whole can work even if there is a decrease in performance.

C. AHP Analysis and Result

1) Decision Hierarchy

The structure of the decision hierarchy can be described as follows :

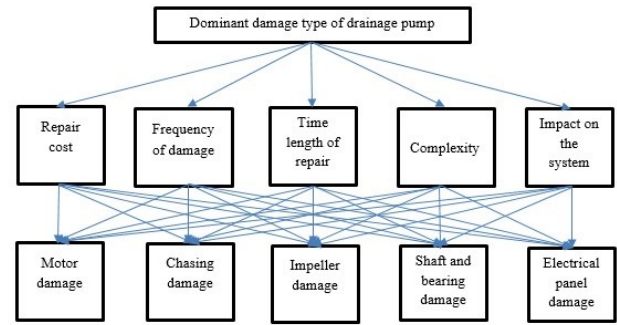

Fig. 1. Decision hierarchy of dominant damage type of drainage pump.

The assessment was carried out by 5 (five) experts from Surabaya Public Works Agency as asset managers and pump companies, with each expert having more than 8 (eight) years experience in drainage pump and system at Surabaya.

2) Criteria Weighing Result

TABLE IV. PAIRWISE COMPARISON CONSOLIDATED MATRIX OF THE MAIN CRITERIA WITH RESPECT TO THE GOAL

	Repair cost	Frequency of damage	Time length of repair	Complexity	Impact on the system
Repair cost	1.000	0.889	0.245	0.344	0.257
Frequency of damage	1.125	1.000	0.344	1.933	0.295
Time length of repair	4.076	2.909	1.000	3.680	1.000
Complexity	2.909	0.517	0.272	1.000	0.576
Impact on the system	3.898	3.393	1.000	1.736	1.000

TABLE V. NORMALIZATION MATRIX OF THE MAIN CRITERIA

	Repair cost	Frequency of damage	Time length of repair	Complexity	Impact on the system	Priorities
Repair cost	0.077	0.102	0.086	0.040	0.082	0.077
Frequency of damage	0.086	0.115	0.120	0.222	0.094	0.130
Time length of repair	0.313	0.334	0.350	0.423	0.320	0.350
Complexity	0.224	0.059	0.095	0.115	0.184	0.133
Impact on the system	0.300	0.390	0.350	0.200	0.320	0.310

The weight rating for all covering criteria is given in Fig. 2. From the ratings as given in Fig. 2, with the inconsistency as expected (under 10 percent), the first two criteria’s priorities (time length of repair and impact on the system) are very close on top, with the weight above 30 percent. Meanwhile, the others have low weight, under 15 percent, especially “repair cost” criteria that under 10 percent. The weight of this criterion will affect the decision making of the dominant level of the type of damage to the drainage pump.

3) Dominant Damage Type Assessment Result

TABLE VI. PAIRWISE COMPARISON MATRIX OF THE DAMAGE TYPE WITH RESPECT TO THE REPAIR COST

	Motor	Chasing	Impeller	Shaft bearing	Panel
Motor	1.000	1.635	2.627	3.680	4.360
Chasing	0.612	1.000	0.517	0.889	2.371
Impeller	0.381	1.933	1.000	3.936	1.528
Shaft bearing	0.272	1.125	0.254	1.000	0.803
Panel	0.229	0.422	0.654	1.246	1.000

TABLE VII. NORMALIZATION MATRIX OF THE DAMAGE TYPE WITH RESPECT TO THE REPAIR COST

	Motor	Chasing	Impeller	Shaft bearing	Panel	Priorities
Motor	0.401	0.267	0.520	0.342	0.433	0.397
Chasing	0.245	0.164	0.102	0.083	0.236	0.163
Impeller	0.153	0.316	0.198	0.366	0.152	0.237
Shaft Bearing	0.109	0.184	0.050	0.093	0.080	0.101
Panel	0.092	0.069	0.130	0.116	0.099	0.102

With respect to repair costs, damage to the motor gets the highest rating with a value of 39.7 percent, followed by damage to impellers, chassis, electrical panels, and shafts and bearings.

TABLE VIII. PAIRWISE COMPARISON MATRIX OF THE DAMAGE TYPE WITH RESPECT TO THE FREQUENCY OF DAMAGE

	Motor	Chasing	Impeller	Shaft bearing	Panel
Motor	1.000	6.119	2.627	1.246	0.222
Chasing	0.163	1.000	0.301	0.245	0.187
Impeller	0.381	3.323	1.000	0.725	0.321
Shaft Bearing	0.803	4.076	1.380	1.000	0.207
Panel	4.514	5.348	3.112	4.829	1.000

TABLE IX. NORMALIZATION MATRIX OF THE DAMAGE TYPE WITH RESPECT TO THE FREQUENCY OF DAMAGE

	Motor	Chasing	Impeller	Shaft bearing	Panel	Priorities
Motor	0.146	0.308	0.312	0.155	0.114	0.199
Chasing	0.024	0.050	0.036	0.030	0.097	0.045
Impeller	0.055	0.167	0.119	0.090	0.166	0.113
Shaft Bearing	0.117	0.205	0.164	0.124	0.107	0.140
Panel	0.658	0.269	0.370	0.600	0.516	0.502

With respect to the frequency of damage, damage to the electrical panel gets the highest rating with a value of 50.2 percent, followed by damage to motors, shafts and bearings, impellers, and chassis.

TABLE X. PAIRWISE COMPARISON MATRIX OF THE DAMAGE TYPE WITH RESPECT TO THE TIME LENGTH OF REPAIR

	Motor	Chasing	Impeller	Shaft bearing	Panel
Motor	1.000	1.528	0.654	1.246	1.246
Chasing	0.654	1.000	0.573	0.985	2.809
Impeller	1.528	1.745	1.000	1.380	2.809
Shaft Bearing	0.803	1.016	0.725	1.000	1.693
Panel	0.803	0.356	0.356	0.591	1.000

TABLE XI. NORMALIZATION MATRIX OF THE DAMAGE TYPE WITH RESPECT TO THE TIME LENGTH OF REPAIR

	Motor	Chasing	Impeller	Shaft bearing	Panel	Priorities
Motor	0.209	0.271	0.198	0.240	0.130	0.210
Chasing	0.137	0.177	0.173	0.189	0.294	0.195
Impeller	0.319	0.309	0.302	0.265	0.294	0.298
Shaft bearing	0.168	0.180	0.219	0.192	0.177	0.187
Panel	0.168	0.063	0.108	0.114	0.105	0.110

With respect to the time length of repair, damage to the impeller gets the highest rating with a value of 29.8 percent, followed by damage to motors, chassis, shafts, and bearings, and electrical panels.

TABLE XII. PAIRWISE COMPARISON MATRIX OF THE DAMAGE TYPE WITH RESPECT TO COMPLEXITY

	Motor	Chasing	Impeller	Shaft bearing	Panel
Motor	1.000	4.514	1.380	3.680	1.380
Chasing	0.222	1.000	0.301	0.272	0.422
Impeller	0.725	3.323	1.000	0.301	0.725
Shaft bearing	0.272	3.680	3.323	1.000	0.803
Panel	0.725	2.371	1.380	1.246	1.000

TABLE XIII. NORMALIZATION MATRIX OF THE DAMAGE TYPE WITH RESPECT TO COMPLEXITY

	Motor	Chasing	Impeller	Shaft bearing	Panel	Priorities
Motor	0.340	0.303	0.187	0.566	0.319	0.359
Chasing	0.075	0.067	0.041	0.042	0.097	0.061
Impeller	0.246	0.223	0.135	0.046	0.167	0.153
Shaft bearing	0.092	0.247	0.450	0.154	0.185	0.224
Panel	0.246	0.159	0.187	0.192	0.231	0.202

With respect to complexity, damage to the motor gets the highest rating with a value of 35.9 percent, followed by damage to shafts and bearings, electrical panels, impellers, and chassis.

TABLE XIV. PAIRWISE COMPARISON MATRIX OF THE DAMAGE TYPE WITH RESPECT TO IMPACT ON THE SYSTEM

	Motor	Chasing	Impeller	Shaft bearing	Panel
Motor	1.000	4.829	2.048	3.323	0.392
Chasing	0.207	1.000	0.232	0.272	0.222
Impeller	0.488	4.317	1.000	2.048	0.461
Shaft bearing	0.301	3.680	0.488	1.000	0.297
Panel	2.551	4.514	2.169	3.366	1.000

TABLE XV. NORMALIZATION MATRIX OF THE DAMAGE TYPE WITH RESPECT TO IMPACT ON THE SYSTEM

	Motor	Chasing	Impeller	Shaft bearing	Panel	Priorities
Motor	0.220	0.263	0.345	0.332	0.165	0.267
Chasing	0.046	0.055	0.039	0.027	0.093	0.050
Impeller	0.107	0.235	0.168	0.205	0.194	0.178
Shaft bearing	0.066	0.201	0.082	0.100	0.125	0.111
Panel	0.561	0.246	0.365	0.336	0.422	0.393

With respect to impact on the system, damage to the electrical panel gets the highest rating with a value of 39.3 percent, followed by damage to motors, impellers, shafts and bearings, and chassis.

TABLE XVI. SYNTHESIZING TO OBTAIN THE FINAL RESULTS

	Repair cost	Frequency of damage	Time length repair	Complexity	Impact on the system	Overall Priority
	0.077	0.130	0.350	0.133	0.310	
Motor	0.397	0.199	0.210	0.359	0.267	0.258
Chasing	0.163	0.045	0.195	0.061	0.050	0.120
Impeller	0.237	0.113	0.298	0.153	0.178	0.224
Shaft bearing	0.101	0.140	0.187	0.224	0.111	0.160
Panel	0.102	0.502	0.110	0.202	0.393	0.239

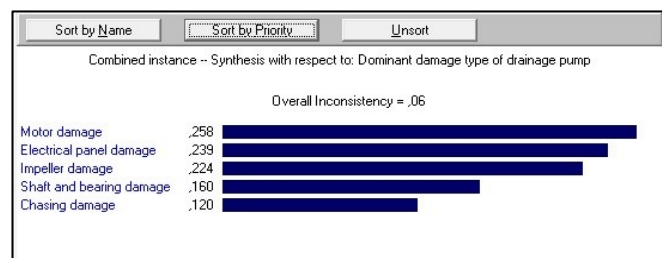

Fig. 2. Dominant damage type assessment result sorted by priority and inconsistency test.

The assessment of the dominant damage type on drainage pump is made with taking into consideration 5 (five) criteria (time length of repair, impact on the system, complexity, frequency of damage, and repair cost), which had been carried out before. With the ratings of 25.8; 23.9; and 22.4 percent, and

overall inconsistency under 10 percent (6 %), three types of damage (motor, electrical panel, and impeller) come close to the top result as the dominant damage type that occurs on the Surabaya drainage pump (Fig. 2). Impeller damage gets a dominant rating on the “time length of repair” criteria, followed by motor damage (Table XI). Meanwhile, the electricity panel damage gets a dominant rating on the “impact on the system” criteria, followed by motor damage (Table XV), and “frequency of damage criteria” (Table IX). Motor damage gets the dominant rating on “repair cost” and “complexity” which are criteria with low weight (Table VII and XIII), but motor damage ratings are quite high on other criteria.

D. Conclusion and Recommendation

Based on the results of calculations using the AHP method, which includes the criteria of repair costs, the frequency of damage, length of repairs, complexity, and impact on the system, motor damage is the dominant type of damage that occurs in the drainage pump at the Surabaya pump station. The analysis above places damage to the motor with a rating of 25.8 percent in the first place, followed by electrical panels (23.9 percent) and impellers (22.4 percent). Motor damage is the most dominant damage in terms of complexity and cost of repairs, it is second on the other criteria, and generally the most dominant for all criteria combined.

From these results, due to the proximity of the rating between the three types of damage, the form of mitigation factors that cause pump damage should focus on that three types of damage to get maximum results on every criterion.

To further focus the mitigation of the risk of damage to the drainage pump, further research is needed to obtain the dominant factor that causes damage to the drainage pump which will be the target of mitigation. The dominant factor that causes damage to the drainage pump can be produced by analyzing three types of damage that get high ratings in the above research. For comparison, similar research can be carried out with different methods.

REFERENCES

Aminbakhsh, S., Gunduz, M., Sonmez, R. (2013). Safety risk assessment using analytic hierarchy process (AHP) during planning and budgeting of construction projects. *Journal of safety research*. 46. 99-105. 10.1016/j.jsr.2013.05.003.

Andriani, Ibrahim, E., Putranto, D., D., A., & Affandi, A., K. (2018). Evaluation of Land Subsidence Impact at Lowland Areas Using Analytical Hierarchy Process (AHP) Method. *E3S Web of Conference*. 68, 0417 (2018)

BPS-Statistic of Surabaya Municipality. (2018). *Surabaya Dalam Angka 2018*. Surabaya: BPS-Statistic of Surabaya Municipality.

Dickenson, T.C. (1995). *Pumping Manual* (9th Edition). Elsevier Advanced Technology.

Korving, H., Geise, M & Clemens, F. (2006). Failure of sewage pumps: Statistical modeling and impact assessment. *Water science and technology: a journal of the International Association on Water Pollution Research*. 54. 119-26. 10.2166/wst.2006.577.

Maletic, D., Maletic, M., Lovrencic, V., Al-Najjar, B., & Gomiscek, B. (2014). An Application of Analytic Hierarchy Process (AHP) and Sensitivity Analysis for Maintenance Policy Selection. *Organizacija*, 10.2478/orga-2014-0016.

R.W. Fox, A.T. McDonald (1995), *Introduction to Fluid Mechanics*, John Wiley & Sons, 781 pp.

Saaty, T.L. (1980). *The Analytic Hierarchy Process*, New York, NY: McGraw-Hill.

- Saaty, T.L. (1990). How to make a decision: The analytic hierarchy process. *European Journal Of Operational Research*, 48(1), 9–26.
- Saaty, T.L. (2008). Decision making with the analytic hierarchy process. *International Journal of Services Sciences*, 1(1), 83–98.
- Tulleken, J. (2012). *Inquiry Into Sewage pump Station Problems With Specific Focus On Removing Solids (Masters Thesis)*. Stellenbosch University.
- Wikipedia. Kota Surabaya. Retrieved January 2019, from https://id.wikipedia.org/wiki/Kota_Surabaya
- Yudiono. (2018). *Analisis Pemilihan Sumber Daya Listrik Utama Untuk Kebutuhan Rumah Pompa Greges (Masters Thesis)*. Institut Teknologi Sepuluh Nopember Surabaya.

Analysis of Caisson Bearing Capacity and Settlement of Abutment in Lemah Abang Bridge

1st Annisa Ramadhani
Faculty of Civil Engineering and
Planing
Islamic University of Indonesia
Indonesia
14511143@students.uui.ac.id

2nd Miftahul Fauziah
Faculty of Civil Engineering and
Planing
Islamic University of Indonesia
Indonesia
miftahul.fauziah@uui.ac.id

3rd Muhammad Rifqi Abdurrozak
Faculty of Civil Engineering and
Planing
Islamic University of Indonesia
Indonesia
rifqi_abdurrozak@uui.ac.id

Abstract - Selection of the type of foundation should be taken accurately because the strength of the foundation as a support for the upper structure greatly influences the strength of building. Wherefore, analysis of foundation carrying capacity and settlement are indispensable. This research aims to determine bearing capacity by applying various methods and the value of settlement that occurs due to loading from upper structures. This research utilizes method, such as Skempton Method, Cooke dan Whitaker Method, Meyerhoff Method, Alpha Method, Lambda Method and Beta Method. It is also employes Finite Element Method, namely Software Plaxis 2D V.8.6 as calculation and modelling tools, final results of the analysis could be compared with empirical and non-empirical methods. The object of this research is Lemah Abang Bridge that located in Sleman Regency and Gunungkidul Regency frontier, Yogyakarta Province, with Well Foundation or Caisson foundation as the lower structure. The results show that the bearing capacity (Q_u) meets the requirements. According to the results, minimum value of Q_u are obtained by using Meyerhoff Method and Beta Method. Furthermore, the value of settlement with empirical method is 2,5075 cm and the settlement with Software Plaxis 2D is 4,62 cm. Based on the results, further analysis are needed by using another empirical methods or other softwares, to get various results.

Keywords— Caisson foundation, Bearing Capacity, Plaxis 2D V.8.6.

I. INTRODUCTION

Based on the sections, bridges consist three section superstructures, substructures and foundation. Superstructures or upperstructures receive dead load and live load. Substructures carry all the upperstructural loads and other loads caused by soil pressure, water flow and drift, friction and collisions on the pedestal and then proceed to the foundation. Foundations proceed all the bridge load from other sections to the ground. Foundation planning for bridge is based on several factors such as the type of soil, the amount of load supported, the condition of the surrounding area, access to the field and others. Typically the foundation used in the bridge structure is a deep foundation.

Based on Pecker (2003) the choice of a design concept for a bridge foundation is guided by various factors; several of these factors are indeed of technical origin, like the environmental conditions in a broad sense, but others non technical factors may also have a profound impact on the final design concept. Selection of the type of foundation should be taken accurately because the strength of the foundation as a support for the upper structure greatly influences the strength

of building, especially for areas that prone to earthquake disasters such as the Special Region of Yogyakarta. This research aims to determine bearing capacity by applying various methods and the value of settlement that occurs due to loading from upper structures. This research utilizes method, such as Skempton Method, Cooke dan Whitaker Method, Meyerhoff Method, α Method, λ Method and β Method. It is also employes Finite Element Method, namely Software Plaxis 2D V.8.6 as calculation and modelling tools, final results of the analysis could be compared with empirical and non-empirical methods. The object of this research is Lemah Abang Bridge that located in Sleman Regency and Gunungkidul Regency frontier, Yogyakarta Province, with Well Foundation or Caisson foundation as the lower structure.

II. LITERATURE REVIEW

A. Foundation

According to Sinaga (2014), deep foundation is substructure of construction that proceed loads from upper structure to bed rock that relatively far from ground level.

Deep foundations have comparison between depth (D_f) and width (B) is more than ten ($D_f/B \geq 10$). There are some aspects from foundation selecting and planning as support structures (Bowles, 1986), The following conditions are :

1. the pressure at the base of foundation may not exceed the allowable capacity of land,
2. the depth of foundation should deep enough in order to prevent soil shrinkage and swelling,
3. structure of foundation should be secure from rolling, rotation and shear,
4. total settlement and differential settlement should not cause structural damage,
5. the implementation of the structure should be economical with the accuracy of the selection of the type, the method of installation, and the selection of tools can save costs,
6. during the work should not disturbing environment.

B. Bearing Capacity

The Analysis of bearing capacity of foundation divided into two types based. There are friction capacity and end bearing capacity.

1. End Bearing Capacity Based on Laboratory Data

a) Skempton Method (1951)

Ground drilling for foundations usually caused lapse in clay shear strength. The Bearing capacity (Qb) with Skempton Method calculated with the Equation 1 below.

$$Q_b = \mu \cdot A_b \cdot N_c \cdot C_b \tag{1}$$

According to Skempton (1966), bearing capacity of end bearing, the value of the supporting capacity factor $N_c = 9$.

b) Cooke and Whitaker Method (1966)

End bearing capacity with Cooke and Whitaker Method (1966) based on the Equation 2 below.

$$Q_s + Q_h = Q + W_s + W_h \tag{2}$$

The observation of Withaker and Cooke (1966) and Berzanatev et al. (1961) show that maximum bearing capacity is a function of settlement (S). End bearing capacity maximum will work on several value of S/B (S = Settlement, B = Diameter or Width) as seen in Table I below.

TABLE VI. PILE MOVEMENT REQUIRED FOR MAXIMUM END BEARING / FRICTION RESISTANCE (WITHAKER AND COOKE, 1966; BEREZANTZEV ET AL., 1961)

S/B	End Bearing / Friction
0,05	Maximum value of friction (Qs)
0,01 – 0,15	The bearing capacity factor is $N_c = 9$ for caisson with the tip enlarged clay.
0,2	he bearing capacity factor is $N_c = 9$ for caisson with normal tip. Bearing capacity ultimit for base caisson with sand or gravel layer.

c) Meyerhoff Method

End bearing capacity with Meyerhoff Method calculated with Equation 3 below.

$$Q_p = A_p \cdot q_p = A_p \cdot c_u \cdot N_c^* = 9 \cdot A_p \cdot c_u \tag{3}$$

2. Friction Capacity Based on Laboratory Data

a) Tomlinson Method (α Method)

Friction capacity with Tomlinson Method or α Method calculated with Equation 4 below.

$$Q_s = A_s \cdot f_s \tag{4}$$

b) Vijayvergiya & Focht Method (λ Method)

Friction capacity with Vijayvergiya & Focht Method or λ Method calculated with Equation 5 and Equation 6 below.

$$\sigma'_{ave} = \frac{\sum_{i=1}^n A_1}{L} \tag{5}$$

$$c_{u\ ave} = \frac{\sum_{i=1}^n A_1}{L} \tag{6}$$

c) Burland Method (β Method)

Friction capacity with Burland Method (λ Method) or effective strain calculated with Equation 5 below.

$$f_{save} = \beta \cdot \sigma' \cdot v \tag{7}$$

3. Bearing Capacity Based on Field Data

d) End Bearing Capacity

Based on N – SPT field data, the amount of bearing capacity calculated with the Equation 8 below.

$$Q_b = A_b \cdot q_d \tag{8}$$

e) Friction Capacity

Friction capacity with N – SPT field data calculated with equation 9 below.

$$Q_s = P \times \sum Li \times fi \tag{9}$$

C. Pile Group Capacity

Pile Group Capacity have greater capacity than single pile capacity, because pile group have more foundations so the load could distributed evenly. The efficiency of the pile group calculated by the Converse - Labarre Method in Equation 10 below.

$$E_g = 1 - \Theta \frac{(m-1)n' + (n'-1)m}{90 m \cdot n'} \tag{10}$$

D. Foundation Settlement

According to Hardiyatmo (2002) settlement of caisson foundation is assumed same as another pile foundation or shallow foundation. The value of settlement depends on clay type. The settlement is calculated by Vesic Method in Equation 11 below.

$$S = \frac{D}{100} + \frac{Q \times L}{A_p \times E_p} \tag{11}$$

E. Software Plaxis 2D

According to Sukumaran, Et al. (1999), the finite element techniques employed are verified against available classical limit solutions. Plaxis 2D is a software that used Finite Element Method concept to analysis displacement, deformation and stability of constructions in geotechnical as a simulation towards soil condition. This application analyze axisymmetric calculation or plane – strain calculation.

III. METHODOLOGY

This research was done in several steps, there were data collecting and literature study, data analysis, results and review, then conclusion and recommendation. Data Collecting and Literature Study was the beginning step in this research as the elementary to got research background, purpose, benefits and research limitation. Datas that used in this research were Detail Engineering Design (DED), soil properties test result,

data planning and other datas to planning bridge. The stages of data analysis are divided into two, first data analysis that used collected data by empirical methods and finite element method used Plaxis 2D software.

The results of the analysis of bearing capacity and settlement will be reviewed in detail in this step. The output were dimensions of foundation, amount pile group, value of bearing capacity and settlement. Datas from results and review would made conclusion, so the results of analysis understood easily. Furthermore researchers gave suggestion and input to facilitate further research, thereby increasing understanding in analyzing the bearing capacity of the foundation.

IV. RESULTS & ANALYSIS

A. Singular Bearing Capacity

The results of end bearing capacity and friction capacity from several methods as seen on Table II below.

TABLE VII. END BEARING CAPACITY AND FRICTION CAPACITY

No	End Bearing Capacity			Friction Capacity		
	Method	Q _p (ton)	Q _p (kN)	Method	Q _s (ton)	Q _s (kN)
1	Cooke and Whitaker	202,026	2062,689	Cooke and Whitaker	61,937	632,374
2	Skempton	165,886	1693,701	Tomlinson (α)	161,700	1650,953
3	Meyerhoff	138,600	1415,103	Vijayvergiya & Focht (λ)	162,915	1663,359
4	N SPT	577,499	5896,261	Burland (β)	154,726	1579,751
5				N SPT	1437,279	14674,615

According to recapitulation results, Meyerhoff Method and Burland Method (β Method) as the smallest results were used. The amount of bearing capacity used for planning was 2991,921 kN.

B. Pile Group Capacity

Based on the results, it was found that Group Efficiency (Eg) was 0,644 with Converse - Labarre Method, The results of Qg1 was 5983,842 kN and Qg2 was 3855,896 kN. From those results, the smallest capacity was used for further foundation planning.

C. Lateral Bearing Capacity

According to Malissa (2009), there is no definitive equation of seismic forces in earthquake coefficient and the equation of earthquake load on the pressure of the soil behind the abutment. Based on Nair's Theory (1969) in the book Pile Foundation Analysis and Design (1980), earthquake force loads on the sub structure was calculated by three methods. There are:

1. for equivalent static, the load lateral loads was assumed 10% of vertical load,
2. for equivalent dynamic loads, the lateral loads was assumed sinusoidal $F(t) = F_0 \sin wt$, and,
3. for bedrock, the lateral load or earthquake acceleration was assumed zero vertical load.
4. Based on these three methods, this study proposes the first method in point a, which was by assuming that lateral

ignition is 10% of the vertical load, so the results of the analysis of the lateral bearing capacity due to the earthquake is 299,192 kN.

D. Foundation Settlement

Analysis of foundation settlement was done to anticipate the failure of structural damage caused by excessive loads. The decrease that occurred in this study was 2.5075 cm.

E. Analysis with Plaxis 2D Software

Geometry modeling of foundation and pilecap structures used plate material, then a predetermined node was defined as 15-node. The model used plane strain with a depiction of illustrated foundations up to a depth of 10 m with a spacing of 0,5. Before modeling with the Plaxis 2D V.8.6 conversion was needed to the plan foundation in 2 dimensional form. The conversion was done to find new dimension values from the foundation in the form of 2 dimensions.

1. Output of the Analysis with Plaxis 2D Software

The result of the Analysis with Plaxis 2D Software could be seen in Fig. 1 until Fig. 2 below.

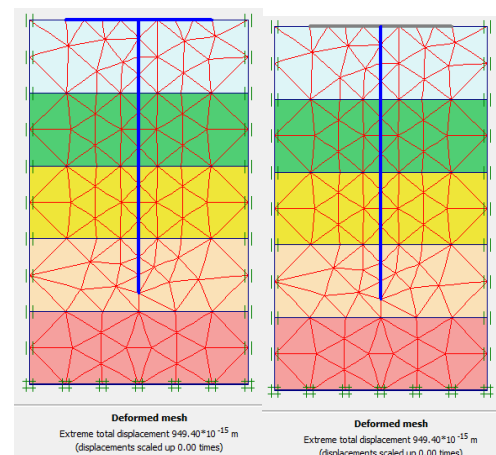

Fig. 1. (a) Results of Analysis in Foundation Installation Phase, (b) Results of Analysis in Pilecap Installation Phase

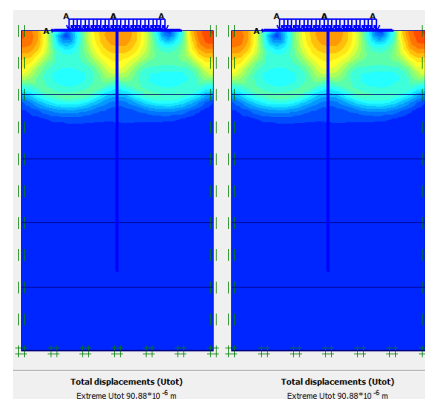

Fig. 2. (a) The results of the analysis on foundation loading phase, (b) Results of Analysis in Safety Factor phase

2. Settlement

The results of the settlement analysis using Plaxis 2D Software was 36.76 x 10⁻³ m or equivalent to 3.676 cm. The results of the settlement with Plaxis 2D was greater than the

settlement with the empirical method, and the results of settlement have met the specified requirements of 7,6 cm as a requirement for settlement of foundation for the bridge structure with normal soil conditions.

Actually the settlement was still reasonable, because at the time of implementation in a relatively long time the foundation will naturally decrease to find stability. The comparison the settlements with the Vesic Method and the results of Plaxis 2D Software analysis served in Fig. 3 below.

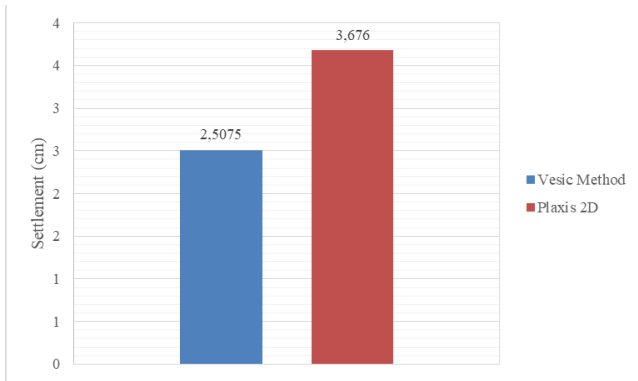

Fig. 3. Comparison of Foundation Settlement with Vesic Methods and Plaxis 2D Software

3. Bearing Capacity

This study aimed to determine how the bearing capacity of the foundation due to earthquake forces occurred either in terms of empirical methods or with finite element methods using Plaxis 2D Software. The results showed that the bearing capacity with Plaxis 2D Software method was greater than the empirical method. The comparison of the two bearing capacities was presented in the form of bar graphs in Fig. 4 below.

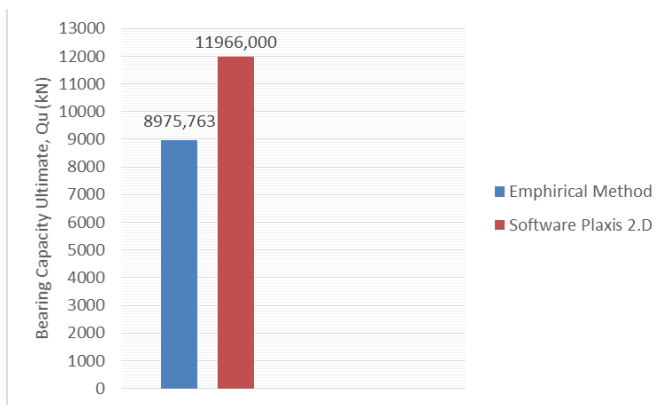

Fig. 4. Comparison of Allowable Bearing Capacity with Empirical Methods and Allowable Bearing Capacity with Plaxis 2D Software

4. Safety Factor

The results of Plaxis 2D Software analysis obtained safety factor value (SF) 1.93, while the safety factor values used in empirical method that referred to Reese and O'neil Safety Factors (1989) was 2.0 with good control of building. Comparison of safety factors was presented in in the form of bar graphs in Fig. 5 below.

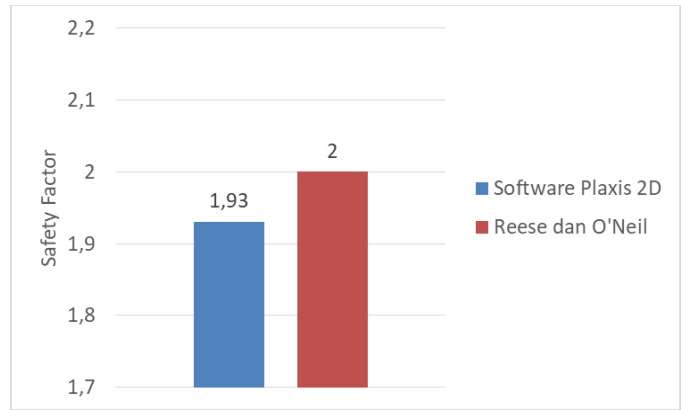

Fig. 5. Comparison of Safety Factor with Empirical Methods and Safety Factor with Plaxis 2D Software

5. Shear and Roll Abutment Stability

The analysis of the rolling and shear stability of the abutment was carried out to proved the safety of abutment. Based on the results of the analysis shear stability in the abutment, the value of the safety factor was 4,314. This value met requirements for shear forces. The SF value must be greater than 2 (> 2). So, abutments are safe against shear forces.

The stability of roll forces was related to the moment that occurred due to lateral soil forces both active and passive soils of roll point, in this study the stability of the roll forces was distinguished into two, transverse direction ((x) direction) and longitudinal direction ((y) direction). Minimum value for roll forces stability both (x) direction and (y) direction was 2,2. The results of roll forces stability (x) direction was presented in Fig. 6 below.

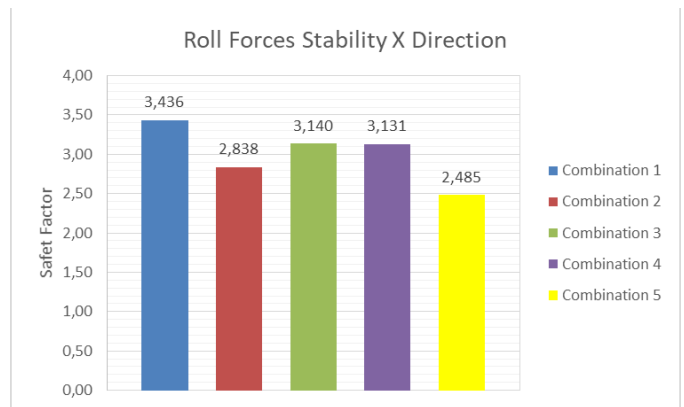

Fig. 6. Safety Factor results of Roll Forces Stability (X) Direction

Based on the results of roll forces stability analysis on abutment, the stability of the (x) direction roll minimum SF results is 2.485, this value met the requirements. The results of roll forces stability analysis on abutment in (y) direction, SF value was 6,003. This value met the safety requirement for rolling, which was greater than 2,2. The results of roll forces stability (y) direction was presented in Fig. 7 below.

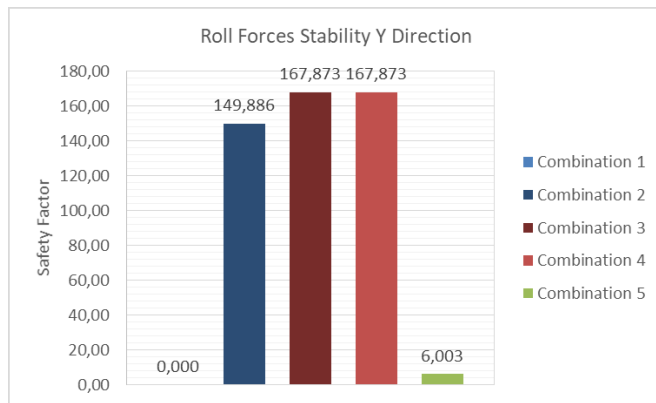

Fig. 7. Safety Factor results of Roll Forces Stability (y) Direction

V. CONCLUSIONS AND RECOMMENDATIONS

Based on the results of analysis and review in this research, here were some points to taken as conclusions and suggestions.

1. The results of the bearing capacity analysis using field data and laboratory data were concluded that:
 - a. the results of the analyzes met earthquake resistance requirements, it assumed that the earthquake force was taken 10% from the vertical force that occurs.
 - b. the existing bearing capacity should be greater than the force and loads that occurred, based on the results of the bearing capacity analysis with some methods, the foundation met the safe requirements, and
 - c. safety factors met the specified requirements.
2. Settlement analysis with empirical methods and Plaxis 2D V8.6 software fulfilled the requirements, maximum settlement requirements was 76 mm or 7,6 cm.
3. Critics and suggestions were needed in this research. It was expected that the critics and suggestions could help in further research with the same theme, here were the suggestions for further research. It was necessary to analyze the bearing capacity with another

empirical methods, so the analysis results will also be varied. Analysis with another finite element method software were needed for example Geo5, L – Pile, Plaxis 3D, Geo Studio, Slope W and others to get varied results.

REFERENCES

- Ahmad, I. (2012). Deflection and Lateral Force Distribution Analysis Due to the Lateral Monotonic Force in the Pile Group Foundation. *Jurnal Konstruksia*. Vol. 3 No. 2, 23 – 31. Jakarta. In Bahasa.
- Aspar, W. A. N, dkk. (2010). Alternative Foundation of Sea Drift Tunnel for Transportation Infrastructure. *Jurnal Sains dan Teknologi Indonesia*, Vol. 12 No.3. 187 – 196. Bandung. In Bahasa.
- B. Sukumaran, W.O. McCarron, P. Jeanjean, H. Abouseeda (1999). Efficient Finite Element Techniques for Limit Analysis of Suction Caissons Under Lateral Loads. *Computers and Geotechnics*. Vol. 24 Pages 89 – 107. USA.
- Brinkgreve, R.B.J. (2007). *Manual Plaxis – Versi 8*. Delft University of Technology & Plaxis b.v. Netherland.
- Bowles, J.E. (1986) *Foundation Analysis and Design: Fifth Edition*. Mc Graw-Hill, New York..
- Fahriani, F. dan Apriyanti, Y. (2015). Analysis of Soil Bearing Capacity and Settlement of Foundation in North Coastal Areas of Bangka Regency. *Jurnal Fropil*, Vol. 3 Nomor 2. Juli – Desember 2015. Bangka Belitung. In Bahasa
- Hardiyatmo, H. C. (2002). *Foundation Technique II: Second Edition*. Beta Offset. Yogyakarta. In Bahasa.
- Harsanto, C., Fabian J. M., J. R.. (2015). Sumampouw. Bearing Capacity Analysis of Bored Pile on the Pylon Structure of Soekarno Bridge with Plaxis 3D. *Jurnal Ilmiah Media Engineering*. Vol.5 No. 2. 345 – 350. Manado. In Bahasa.
- Mallisa, Z. (2009). Analysis o of Earthquake Building of Bridges Substructures. *Media Litbang Sulteng* 2 (2) :121 – 125. Palu. In Bahasa
- Plaxis 2D. (2017). *Material Models Manual version 8.6*. Netherland
- Pecker, A. (2003). Aseismic foundation design process, lessons learned from two major projects: the Vasco de Gama and the Rion Antirion bridges. *ACI ACI International Conference on Seismic Bridge Design and Retrofit*. California.
- Poulos, H.G. dan E.H. Davis. (1980). *Pile Foundation Analysis and Design*. John Wiley and Sons. New York.
- H.G. Poulos, J.C. Small, and H. Chow. (2011) Piled raft foundations for tall buildings, *Geotechnical Engineering Journal of the SEAGS & AGSSEA*, Vol 42 No 2 78–84. New York.
- Sosrodarsono, S. dan Kazuto N. (1981). *Soil Mechanics and Foundation Techniques*.PT. Pradnya Pramita. Jakarta. In Bahasa.

Priority Factors for The Sustainability of Local Road Under Community-Based Management in Slum Areas at Pasuruan City

1st Ayu Rahmaniyah
Students of Civil Engineering
Department, Faculty of Civil,
Environmental & Geo Engineering
Sepuluh Nopember Institute of
Technology
Jalan Raya ITS, Surabaya 60111,
Indonesia
ayuramukti@gmail.com

2nd Hitapriya Suprayitno
Civil Engineering Department, Faculty
of Civil, Environmental & Geo
Engineering,
Sepuluh Nopember Institut of
Technology
Jalan Raya ITS, Surabaya 60111,
Indonesia
suprayitno.hita@gmail.com

3rd Eko Budi Santoso
Regional and Urban Planning
Department, Faculty of Architecture,
Design & Planning,
Sepuluh Nopember Institut of
Technology
Jalan Raya ITS, Surabaya 60111,
Indonesia
santosoeb@gmail.com

Abstract— *The Pasuruan City Government has carried out activities to improve the quality of local road infrastructure in slum areas through the NUSP program, to realize the Target City Without Slums in 2020. The sustainability of this local road function is strongly influenced by the sustainability of infrastructure assets management stages, starting from the planning and construction, operation, and maintenance. The operation, and maintenance conducted by the User and Keeper Groups (KPP). This study aims to determine the priority factors for the sustainability development of local road functions in slums with community-based management in Pasuruan City. Determination of priority factors is carried out by assessing the suitability of the sustainability factors through the assessment questionnaires to the KPP, while the priority factor for the development of sustainability with the method of Borda analysis is based on the expert's assessment. The results of this study indicate that in the operation stage, the factors needed to be prioritized are the physical condition of the infrastructure, the management quality, and financial management ability. Whereas in the maintenance stage, it is necessary to prioritize the management quality, transparency of financial management, and coordination with the government.*

Keywords— *Infrastructure Management, Local Road, Sustainability Function, Priority Factor, Community-based Management*

I. INTRODUCTION

In realizing the function of healthy, habitable and sustainable settlements, Direktorat Jenderal Cipta Karya, Kementerian Pekerjaan Umum dan Perumahan Rakyat has launched the “Kota Tanpa Kumuh (KOTAKU)” program. The target of reducing the slum area to 0% is done by providing adequate infrastructure in each settlement. Development programs designed to support efforts to release the city from the slum problem, one of which is implemented by the Neighborhood Upgrading and Shelter Project Phase-2 (NUSP-2) Program. Pasuruan City is the only city in East Java that has received assistance in handling slum settlements with the implementation of the NUSP-2 program since 2015. The area of slum settlements in Pasuruan City has a total area of 68.12 Ha and is spread

in 11 urban villages. The implementation of the NUSP-2 program in the city of Pasuruan focuses on infrastructure management carried out by, from, and for the community, starting from the planning, construction, utilization, to maintenance stages.

One of the infrastructures managed by the community is a local road, as the main infrastructure to improve accessibility more smoothly and easily, to improve the quality of slum settlement services. To improve the sustainability of local road functions, the management of the local road is also needed. This management will be easier to be implemented if each implementation process has program alignment starting from the planning, construction, utilization, maintenance, and improvement phases. So for this purpose, a User and Keeper Group (KPP) was formed as a community empowerment group that has the main task of maintaining the sustainability of infrastructure functions in slums. But in its implementation, there are still KPPs that have not succeeded in realizing the sustainability of local road functions, resulting in a decrease of the local roads quality in the slums area.

Therefore, it is necessary to determine the priority factors that influence the development of local road sustainability in Pasuruan City by optimizing the role of infrastructure management owned by KPP in each urban villages as the user and keeper of slum infrastructure.

II. LITERATURE REVIEW

A. Sustainable Management of Local Roads

Based on Indonesian Constitution no. 38 of 2004 concerning Roads, the process of development management and road management starts from the stages of programming and budgeting activities, technical planning, construction, and road operation and maintenance. This management also refers to the principles of Infrastructure Asset Management. Where infrastructure assets management (IAM) is the task, knowledge, and science to manage infrastructure, throughout the entire life cycle, in order that infrastructure be able to sustainably function

economically, effectively, efficiently, and in accordance with the principles of economic, social, and environmental sustainability (Suprayitno & Soemitro, 2018. Park, 2016). Sustainable road management is a mandatory business for all road operators. According to Lawalata (2017), sustainable roads are roads that are built with various efforts so that there is a balance between environmental, economic, and social aspects.

Based on the NUSP-2 (2016) program's Technical Guidelines for Operation and Infrastructure Maintenance for local roads emphasis is on routine maintenance which aims to control and maintain the infrastructure and keep the facilities in good condition to prevent failure (infrastructure does not function suddenly). In addition to this, with routine maintenance, small damage is quickly discovered, can be improved immediately, and does not cause major damage or malfunction. Routine maintenance keeps the condition of the infrastructure in its original state and includes several repetitive jobs, which are technically quite simple. Routine maintenance must begin when the infrastructure is completed (still in new condition) and continue for the duration of the infrastructure.

B. Community Empowerment in the Sustainability of Local Road Management

Kodoatie (2005) emphasizes that changes in the handling or management of roads are very important to strengthen the factors of community participation in them. The main objective of strengthening this community participation is to create better road conditions, improve road user services, lower vehicle operating costs, and increase economic growth. The participation of the community in managing this road is in line with the mandate stated in the Minister of Public Works Regulation No. 01 / PRT / M / 2012 that in order to improve the quality of road maintenance, an integrated pattern of road management between the government and the road user community is needed, so as to create a performance that is more effective. The pattern of the role of the community in road management is that the community is involved directly or indirectly in the operation of the road. The community is involved in each stage of the Road Implementation, starting from the arrangement, guidance, development, and supervision. The role of the community can take the form of anything such as material, financial, and thoughtful contributions.

C. The Success of Sustainable Infrastructure Management with Community Participation

Korten (in Faza, 2017) states that a program will be successfully implemented if there is the suitability of the three elements of program success, namely conformity between programs and users, conformity between programs and implementing organizations, and conformity between user groups and implementing organizations. The success of this sustainability also needs to identify the sustainability of economic, environmental, and social aspects (Lestari, 2013). Based on the NUSP-2 Program Implementation Guidelines (Dirjen Cipta Karya, 2016), the sustainability of an infrastructure management activity is highly dependent on the performance of the KPP in running an efficient and effective work program. Where are the indicators of KPP's success in realizing infrastructure sustainability, namely (1)

Infrastructure is functioning properly and its quality is maintained; (2) Infrastructure can be operated/utilized in the long term (at least according to the planning lifetime); (3) Institutionalization of KPP at the community level, including the involvement of women; (4) Establishment of partnerships with government institutions, other organizations and the private sector; (5) The realization of independent O & M by beneficiaries in carrying out work programs including aspects of financing; (6) Can expand the range of benefits by not causing negative impacts on the environment.

III. METHOD

A. Variables, Population and Sampling

The variables in this study are aspects, stages, and sustainability factors of the local road in the Pasuruan City slums. The expected output is a priority factor that influences the success and sustainability of local road based on community participation. The research sample was limited to 6 experts and 65 community administrators of KPP and BKM in 11 slum category urban villages in Pasuruan City. The selection of research and sampling locations was based on slum location, which received assistance from the NUSP-2 Program and the NUSP-2 Program infrastructure management organization.

B. Method of Collecting Data

The analysis is based on primary data and secondary data. Primary data is obtained from questionnaires and interviews with relevant parties in determining the local roads sustainability factor in the Pasuruan City slums. While secondary data is obtained from the literature related to slum settlement infrastructure management policies based on sustainable community participation, Government Regulations related to local road management, and profile of Pasuruan City slum infrastructure. The questionnaire was carried out in two stages, the first stage of the questionnaire to experts related to the identification of stages and sustainability factors of the local road in Pasuruan City, then the second stage of the questionnaire to the community to determine the level of local road sustainability with community participation based management in Pasuruan City slums.

C. Stages of Research

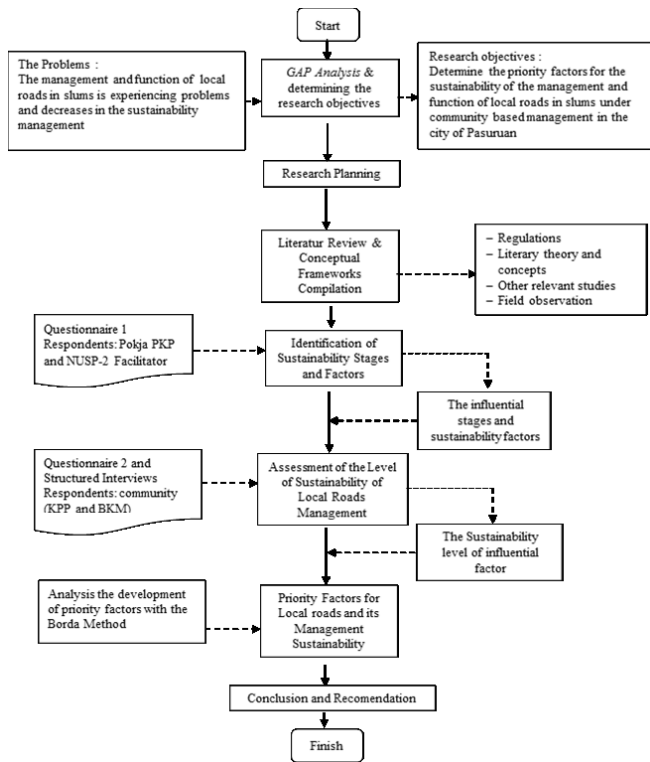

Fig. 1. Stages of Research

The stages in this study are as follows: (1) identification the influential stages and sustainability factors of the local road with community-based management in Pasuruan, (2) determining the sustainability level of each factor in community-based local road management in Pasuruan City, (3) determine the influential priority factors by analyzing each slum area with the method of Borda analysis that based on the expert's assessment. In this study, the expert is the stakeholders who act as a policy maker and was directly involved in the management of slum infrastructure at Pasuruan City.

IV. RESULT AND ANALYSIS

Slum areas in Pasuruan City are spread in 11 urban villages with a total area of 68.12 Ha. This slum area consists of 3 types of areas characteristics that are fishermen's settlement areas (consisting of Gadingrejo, Tambaan, Ngemplakrejo, and Panggungrejo Urban Villages), supporting areas for fishermen activities (Trajeng, Mayangan, and Mandaranrejo Urban Villages), and urban residential areas (Kebonsari, Bangilan, Kandangsapi, and Bugul Lor Urban Villages). This characteristic affects the local road management that will be carried out to solve the problem of slums. An assessment of local road management sustainability will be carried out in 11 urban villages. The following are the distribution of local roads location in the slums area at Pasuruan City based on Pasuruan City's NUAP Document (2016).

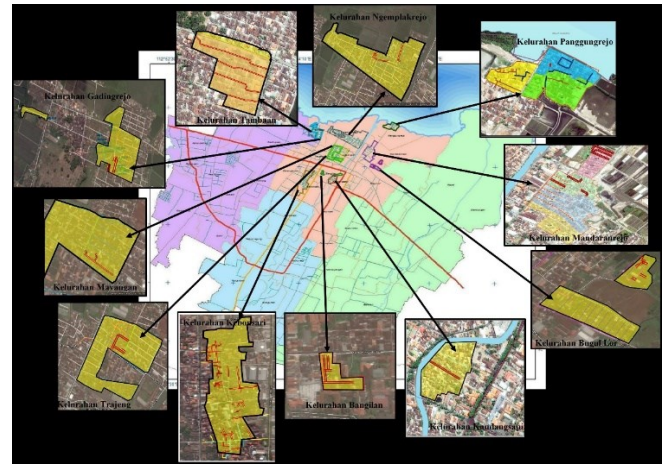

Fig. 2. Local Road Locations in the Slums at Pasuruan City

A. Identification of the Stages and Factors of Local Road Sustainability with Influential Community-Based Management in Pasuruan City

From the results of interviews and questionnaires to experts who deal directly with the management of slum infrastructure in the City of Pasuruan, the factors that are relevant in influencing the sustainability of local roads with community-based management in the slums of Pasuruan City are obtained. Of the 31 factors proposed in the questionnaire, 26 of the most relevant and influential factors were chosen. These 26 factors are divided into four aspects (technical, institutional, financial, social, and environmental aspects) and three stages of management (planning and construction stages, operational and utilization stages, and also maintenance and improvement stages). These aspects, stages, and factors will be used in this study to assess the suitability of sustainability and determine which factors will be prioritized. The most relevant and influential factors in local road management sustainability at Pasuruan City as follows:

TABLE I. THE INFLUENTIAL ASPECT, STAGES, AND FACTORS OF SUSTAINABILITY LOCAL ROAD WITH COMMUNITY-BASED MANAGEMENT IN PASURUAN CITY

No	Factors	Reference	Local Road Management Stages
1. Aspect Technical			
1.1	Availability of resources and materials	Darmawanto (2006), Alit (2005), Degert (2016)	Planning and Construction Stage
1.2	Infrastructure physical conditions	PP 34/2006, Permen PUPR 2/2016, NUSP-2 Program Implementation Guidelines, Pujiarman (2016)	Operational and Utilization Stage
1.3	Infrastructure performance	PP 34/2006, Permen PUPR 19/2011, Permen PUPR 2/2016, NUSP-2 Program Implementation Guidelines, Lawalata (2017), Pujiarman (2016)	
1.4	Availability of materials	Lawalata (2017), Pujiarman (2016), Degert (2016)	Maintenance and Improvement Stage
2. Aspect Institutional			

No	Factors	Reference	Local Road Management Stages
2.1	Quality management of infrastructure construction work programs	Permen PU 01/2012, NUSP-2 Program Implementation Guidelines, Lawalata (2017), Kodoatie (2005), Faza (2011), Darmawanto (2006), Persada (2014), Park (2016)	Planning and Construction Stage
2.2	Facilitators Accompaniment	NUSP-2 Program Implementation Guidelines, Mutia (2017), Banteng (2015)	
2.3	The Existence of the manager	Permen PU 01/2012, NUSP-2 Program Implementation Guidelines, Lestari (2013), Prayitno (2016), Faza (2011), Darmawanto (2006), Pujiarman (2016), Mutia (2017), Banteng (2015), Persada (2014), Meredith (2017), Degert (2016)	Operational and Utilization Stage
2.4	Quality of management organization	NUSP-2 Program Implementation Guidelines, Kodoatie (2005), Faza (2011), Darmawanto (2006), Narsatya (2001), Kamulyan 2.5(2017), Pujiarman (2016), Banteng (2015), Persada (2014), Degert (2016), Park (2016)	
2.5	Quality management of infrastructure operational work programs	Permen PU 01/2012, NUSP-2 Program Implementation Guidelines, Lawalata (2017), Kodoatie (2005), Faza (2011), Darmawanto (2006), Mutia (2017), Persada (2014), Park (2016), Parlikad (2016)	
2.6	Coordination with the government	NUSP-2 Program Implementation Guidelines, Faza (2011), Darmawanto (2006), Narsatya (2001), Pujiarman (2016), Mutia (2017), Persada (2014), Degert (2016)	Maintenance and Improvement Stage
2.7	Quality management of infrastructure maintenance and improvements work program	Permen PU 01/2012, NUSP-2 Program Implementation Guidelines, Lawalata (2017), Kodoatie (2005), Faza (2011), Darmawanto (2006), Narsatya (2001), Mutia (2017), Persada (2014), Park (2016)	
2.8	Monitoring and evaluation	Permen PU 01/2012, , NUSP-2 Program Implementation Guidelines, Faza (2011), Darmawanto (2006), Pujiarman (2016), Degert (2016)	

No	Factors	Reference	Local Road Management Stages
2.9	The level of resolved complaints	NUSP-2 Program Implementation Guidelines, Lawalata (2017), Faza (2011), Pujiarman (2016)	
3. Aspect Financial			
3.1	Financial management ability	NUSP-2 Program Implementation Guidelines	Operational and Utilization Stage
3.2	Transparency of financial management	NUSP-2 Program Implementation Guidelines, Narsatya (2001), Park (2016)	Maintenance and Improvement Stage
3.3	The Existence of community fees	Permen PU 01/2012, NUSP-2 Program Implementation Guidelines, Kodoatie (2005), Darmawanto (2006), Kamulyan (2017), Mutia (2017), Pujiarman (2016), Degert (2016)	
3.4	Availability of maintenance and improvement costs	NUSP-2 Program Implementation Guidelines, Lawalata (2017), Darmawanto (2006), Kamulyan (2017), Mutia (2017), Degert (2016)	
3.5	Support and Partnerships in financing the maintenance and improvements	NUSP-2 Program Implementation Guidelines, Darmawanto (2006), Pujiarman (2016), Faza (2011), Degert (2016), Parlikad (2016)	
4. Aspect Social			
4.1	Community involvement in the planning and construction process	Permen PU 01/2012, NUSP-2 Program Implementation Guidelines, Lawalata (2017), Lestari (2013), Prayitno (2016), Kodoatie (2005), Narsatya (2001), Kamulyan (2017), Pujiarman (2016), Alit (2005), Persada (2014), Majale (2008), Meredith (2017), Degert (2016)	Planning and Construction Stage
4.2	Dissemination of infrastructure management plans	Permen PU 01/2012, NUSP-2 Program Implementation Guidelines, Alit (2005), Degert (2016)	Operational and Utilization Stage
4.3	Community participation in institutions and management	Permen PU 01/2012, NUSP-2 Program Implementation Guidelines, Lawalata (2017), Lestari (2013), Prayitno (2016), Kodoatie (2005), Narsatya (2001), Kamulyan (2017), Pujiarman (2016), Alit (2005), Persada (2014), Majale (2008), Meredith (2017), Degert (2016)	

No	Factors	Reference	Local Road Management Stages
4.4	The Contribution of women in management	NUSP-2 Program Implementation Guidelines, Pujjarman (2016), Majale (2008), Degert (2016)	Maintenance and Improvement Stage
4.5	The Level of community satisfaction	NUSP-2 Program Implementation Guidelines, Kamulyan (2017)	
4.6	The Motivation of public awareness in maintenance and improvements	Permen PU 01/2012, NUSP-2 Program Implementation Guidelines, Lestari (2013), Prayitno (2016), Kodoatie (2005), Kamulyan (2017), Alit (2005), Majale (2008), Meredith (2017), Degert (2016)	
5. Aspect Environmental			
5.1	Availability of drainage channels	NUSP-2 Program Implementation Guidelines, Lawalata (2017), Degert (2016)	Operational and Utilization Stage
5.2	Availability of local street lighting	NUSP-2 Program Implementation Guidelines, Lawalata (2017)	

B. The Levels of Local Roads Management Sustainability Based on Community Participation

The calculation of the level of sustainability of local roads management factors based on community participation was done by scoring answers using a rating scale of 1 to 5 followed by interval determination of percent scores using the formula $I = 100 / \text{number of scoring}$ (Prisanto et al., 2015). Then obtained the level of sustainability that will be classified per management aspect as follows:

1) *Index and sustainability levels of technical aspects:* The highest index value lies in the infrastructure performance factor, which is equal to 80,46 %. Where this proves that the local road that has been built and managed by the community has been able to function as a liaison area that provides convenience, security, and convenience for the community of users. For the lowest index value is the physical condition of the infrastructure factor, which is equal to 70,77 %. This condition is very dependent on the activeness of KPP in moving the community to be more concerned about the process of utilizing and maintaining local roads. Overall, the technical aspects have an average sustainability index of 75,19 % and are included in the sustainable category interval.

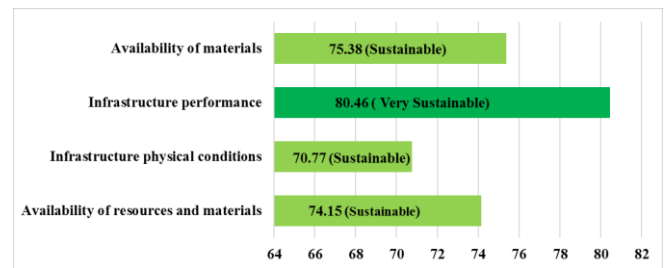

Fig. 3. Index and Sustainability Levels of Technical aspects (%)

2) *Index and sustainability levels of Institutional aspects:* The highest index value lies in the quality management of infrastructure construction work programs factor, which is equal to 77,54 %. Management of the construction work program has been carried out according to existing plans and provisions, under the supervision of the relevant technical services and assisted by facilitators so that the BKM and KPP in their implementation are more orderly and organized than the implementation of the operational and maintenance stage. For the lowest index value is the facilitator accompaniment factor which is equal to 62,62 % because after the construction period the facilitator is no longer in charge of assisting the community so that this factor is not sustainable. Overall, the institutional aspects have an average sustainability index of 68,25 % and are included in the interval of a sustainable category but within a minimum limit.



Fig. 4. Index and Sustainability Levels of Institutional Aspects (%)

3) *Index and sustainability levels of financial aspects:* The highest index value lies in the transparency of financial management factor, which is equal to 62,15 %. Most KPPs have routinely provided information on local road management funding, although still there are KPPs that have not been able to be transparent due to the lack of funding they have so that KPP has not found the right mechanism to report on existing funding turnover. For the lowest index values are support and partnership in financing maintenance and improvements factor which is equal to 34,62 % because it is a very minimal allocation of funding support from the government. This is because the infrastructure that has been fully handed over to the community is also the responsibility of the community. Overall, the financial aspects have an average sustainability index of 47,72 % and are included in a quite sustainable category interval but within a minimum limit.

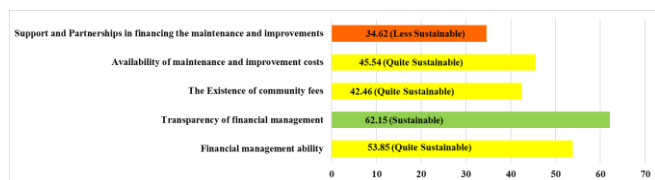

Fig. 5. Index and Sustainability Levels of Financial Aspects (%)

4) *Index and sustainability levels of social aspects:* The highest index value lies in the community involvement in planning and construction process factor, which is equal to 76,92 %, where the community was chooses, surveys and built its own local road to improve its services. While for the lowest index value is the factor of community participation in institutions and management, which is equal to 66,26 %. The community involved in the early stages of planning turned out to experience a decrease in motivation to be actively involved in the process of utilization and maintenance. Apart from the fact that there is no direct supervision from the government, KPP does not actively mobilize the community. So that there are still many people who do not understand the local road management policies. Overall the social aspects have an average sustainability index of 70,92 % and are included in the sustainable category interval.

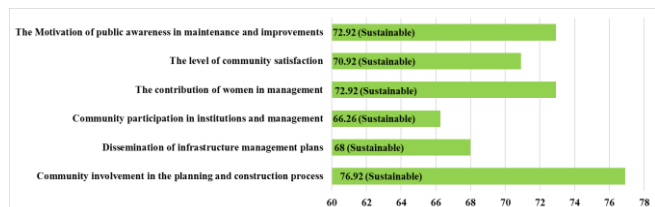

Fig. 6. Index and Sustainability Levels of Social Aspects (%)

5) *Index and sustainability levels of environmental aspects:* The highest index value lies in the availability of drainage channel factors which is equal to 70,77%, with channel conditions mostly in good condition and functioning optimally. The function of the maintained drainage channel is mainly because the community routinely holds cooperation to clean the drainage canal. Whereas for the lowest index value is the factor of Availability of local street lighting, which is equal to 65,85%, where the operation and maintenance have separate funds from the community fees. Overall the environmental aspects have an average sustainability index of 68,31% and are included in the sustainable category interval.

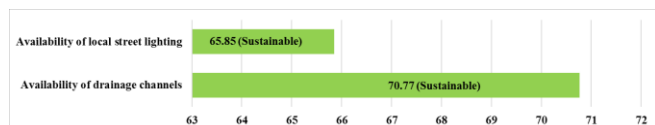

Fig. 7. Index and Sustainability Levels of Environmental Aspects (%)

C. Influential Priority Factors on Local Road Sustainability with Community-Based Management in Pasuruan City

After calculating the index and the level of sustainability of the factors in each aspect, then the analysis of the suitability of local road conditions is then carried out

with the sustainability of aspects and factors in each urban village. This analysis is to find out which areas are successful, sufficient, and have not succeeded in realizing local roads sustainability. The output obtained from this analysis is regional grouping based on the type of success and priority factors that need to be developed to improve the sustainability of the local road with community-based management. To determining the arrangement of priority factors that need to be developed in each urban village, the ranking assessments have been carried out by experts (by filling out the Borda Questionnaire) with the method of Borda analysis. The following are priority factors resulting from Borda Analysis per each urban village:

TABLE II. THE INFLUENTIAL ASPECT, STAGES, AND FACTORS OF SUSTAINABILITY LOCAL ROAD WITH COMMUNITY-BASED MANAGEMENT IN PASURUAN CITY

No.	Urban Villages and Sustainability of the Environment Road	Priority factors that need to be developed
1	<p>This areas consist of 5 urban villages as a follows:</p> <ol style="list-style-type: none"> 1) Kandangsapi 2) Bugul Lor 3) Kebonsari 4) Bangilan 5) Trajeng <p>The physical condition of the local road in this areas is in good condition and has a sustainable function</p> <p>Factors in the technical, institutional, financial, social, and environmental aspects have a good level of sustainability. The level of sustainability for this region is 73,91 %</p>	<p>Supporting factors for sustainable areas that must be developed and used as examples for other urban villages are:</p> <ol style="list-style-type: none"> 1. Transparency of financial management (0.060779) 2. Quality management of infrastructure maintenance and improvements work program (0.059829) 3. Infrastructure performance (0.054606) 4. Quality of management organization (0.053656) 5. Community participation in institutions and management (0.052232) 6. The Motivation of public awareness in maintenance and improvements (0.051282) 7. Dissemination of infrastructure management plans (0.047958) 8. Quality management of infrastructure operational work programs (0.04416) 9. The Existence of the manager (0.04321) 10. Coordination with the government (0.041785)
2	<p>This areas consist of 3 urban villages as a follows:</p> <ol style="list-style-type: none"> 1) Mandaranrejo 2) Mayangan 3) Gadingrejo <p>Physical conditions Local roads are in a quite good condition and have a sustainable function</p> <p>Factors in institutional, financial, social aspects have a lack of sustainability. The level of sustainability for this region is 60,79 %</p>	<p>The inhibiting factor for sustainability that must be prioritized to be developed is:</p> <ol style="list-style-type: none"> 1. Quality management of infrastructure maintenance and improvements work program (0.072175) 2. Quality of management organization (0.059354) 3. Availability of maintenance and improvement costs (0.053181) 4. The Motivation of public awareness in maintenance and improvements (0.051282) 5. Quality management of infrastructure operational work programs (0.050807) 6. Infrastructure performance (0.054606) 7. Coordination with the government (0.044159)

No.	Urban Villages and Sustainability of the Environment Road	Priority factors that need to be developed
		8. Infrastructure physical conditions (0.043210) 9. Financial management ability (0.043210) 10. Monitoring and evaluation (0.041785)
3	This areas consist of 3 urban villages as a follows: 1) Panggungrejo 2) Tambaan 3) Ngemplakrejo Physical conditions Local roads are in poor condition and less sustainable functions Factors in technical, institutional, financial, social, and environmental aspects have a lack of sustainability. The level of sustainability for this region is 57,03 %	The inhibiting factor for sustainability that must be prioritized to be developed is: 1. Quality management of infrastructure operational work programs (0.06980) 2. Quality of organizational management (0.066477) 3. Availability of maintenance and improvement costs (0.061728) 4. Community participation in institutions and management (0.052706) 5. Infrastructure physical conditions (0.051757) 6. Coordination with the government (0.047958) 7. Quality management of infrastructure maintenance and improvements work program (0.047958) 8. Infrastructure performance (0.047008) 9. Financial management ability (0.044159) 10. The Motivation of public awareness in maintenance and improvements (0.044159)

V. CLOSURE AND RECOMMENDATION

Identification of aspects, stages and sustainability factors of the local road that are relevant to the management of local roads in the city of Pasuruan is carried out with a study of literature followed by the selection of factors by experts, the related department and facilitator of the NUSP-2 program in Pasuruan. Each factor in each aspect and stage is identified as the implementation condition, index, and level of sustainability. From the results of the analysis, it is known that the factors in the technical aspects have the highest value of 75,19% and the factors in the financial aspects have the lowest value of 47,72%. Overall, the sustainability of local road management in the settlements of Pasuruan City is at a sustainable level, with an index of 66.16%. This sustainability is at a minimum for the types of sustainable levels. Therefore an analysis of the suitability of existing conditions is carried out with the sustainability of each factor in the 11 urban villages so that prioritization factors that must be improved can be identified in each urban villages.

Suitability and Borda analysis produce priority factors that need to be developed in 3 types of regions, areas that are sustainable, quite sustainable, and less sustainable. Priority factors generated in the operational and utilization stages are the condition and performance of infrastructure; quality of infrastructure management; quality of organizational management; Financial management ability; and Community participation in institutions and management. While the priority factor produced at the

maintenance stage is transparency of financial management; quality management of infrastructure maintenance and improvements work program; coordination with the government; monitoring and evaluation, availability of maintenance costs, and community motivation in maintenance.

REFERENCE

Alit, I Ketut.(2005). PEMBERDAYAAN Masyarakat Dalam Peningkatan Kualitas Lingkungan Permukiman Kumuh Di Propinsi Bali. *Jurnal Permukiman Natak*.(3), 34-43.

Banteng, Beby S.D.(2015). Analisis Keberhasilan Partisipasi Masyarakat Dalam Upaya Peningkatan Kualitas Permukiman Kumuh Di Kota Gorontalo. *Prosiding PESAT (Psikologi, Ekonomi, Sastra, Arsitektur & Teknik Sipil)*.Universitas Gunadarma, (06), T-1-T-5.

Bouyssou, D., Marchant, T., Pirlot, M., Tsoukias, A. And Incke, P. (2006). *Evaluation and Decision Models With Multiple Criteria*. New York. Springer-Verlag, Inc.

Darmawanto, Wahyu Tri (2006). Peran Serta Masyarakat Dalam Pengelolaan Pemeliharaan Jalan Pada Perumahan Korpri Sambak Indah, Purwodadi, Tesis, Universitas Diponegoro, Semarang.

Degert, Isoline. Parikh, Priti. Kabir Rumana. (2016). Sustainability Assessment of A Slum Upgrading Intervention in Bangladesh. *Cities*. 56, 63-73.

Faza, Tegar Ilham & Suwitri, Sri. (2017). Evaluasi Keberhasilan Program Penyediaan Air Minum Dan Sanitasi Berbasis Masyarakat (Pamsimas) Di Kabupaten Tegal. *Journal Of Public Policy And Management Review*, 6(1), 35-50.

Henderson, Ken. Pahlenkemper, Georg & Kraska, Olaf. (2014). *Integrated Asset Management – An Investment in Sustainability*. *Procedia Engineering*. 83, 448-454.

Kamulyan, Puji (2018). Evaluasi Keberlanjutan Pengelolaan Sistem Penyediaan Air Minum Berbasis Masyarakat di Kota Blitar, Tesis, Institut Teknologi Sepuluh November, Surabaya.

Kementerian Pekerjaan Umum dan Perumahan Rakyat. (2015). *Pedoman Umum Neighborhood Upgrading and Shelter Project Phase 2*. Jakarta: Direktorat Pengembangan Kawasan Permukiman Direktorat Jenderal Cipta Karya.

Kodoatie, Robert. (2005). *Pengantar Manajemen Infrastruktur*. Yogyakarta: Pustaka Belajar.

Kogoya, Teraik, dkk. (2015). Partisipasi Masyarakat Terhadap Pembangunan Infrastruktur Jalan Desa Di Kabupaten Lanny Jaya-Papua. *Jurnal Berkala Ilmiah Efisiensi*, 15(2), 121-135.

Lawalata, Greece Maria. (2017). Usulan Indikator Jalan Berkelanjutan untuk Indonesia. *Jurnal Jalan-Jembatan*, 34(1), 33-47.

Lestari, Indah Dwi dan Sugiri, Agung.(2013). Peran Badan Keswadayaan Masyarakat Dalam Penanganan Permukiman Kumuh Di Podosugih, Kota Pekalongan. *Jurnal Teknik PWK UNDIP* (2), 30-41.

Lestari, Indah Dwi & Sugiri, Agung. (2013). Peran Badan Keswadayaan Masyarakat Dalam Penanganan Permukiman Kumuh Di Podosugih, Kota Pekalongan. *Jurnal Teknik PWK UNDIP*, 2(1), 30-41.

Majale, Michael. (2008). *Employment Creation Through Participatory Urban Planning and Slum Upgrading: The Case of Kitale, Kenya*. *Habitat International*. 32, 270-282.

Meredith, Thomas. MacDonald, Melanie. (2017). *Community-Supported Slum-Upgrading: Innovations From Kibera, Nairobi, Kenya*. *Habitat International*. 60, 1-9.

Muchadenyika, Davison. (2015). *Slum Upgrading and Inclusive Municipal Governance in Harare, Zimbabwe: New Perspectives For The Urban Poor*. *Habitat International*. 48, 1-10.

- Mutia, Nur (2017). Analisa Hasil Pembangunan MCK Plus Berbasis Masyarakat di Provinsi Aceh. *Jurnal Arsip Rekayasa Sipil dan Perencanaan (JARSP)*, 1(1), 101-111.
- Narsatya, Kasihandayani.(2001). Peran Serta Masyarakat Dalam Pengelolaan Infrastruktur Jalan Di Kawasan Perumahan Formal, Tesis,Institut Teknologi Sepuluh November, Surabaya.
- Park, Sanghoon. Park, Sang I & Lee, Sang Hoon. (2016). Strategy on Sustainable Infrastructure Asset Management: Focus On Korea's Future Policy Directivity. *Renewable and Sustainable Energy Review*. 62, 710-722.
- Parlikad, A K. Jafari, M. (2016). Challenges in Infrastructure Asset Management. *IFAC-PapersOnLine*. 49-28, 185-190.
- Peraturan Menteri Pekerjaan Umum Nomor 01/PRT/M/2012 Tentang Pedoman Peran Masyarakat Dalam Penyelenggaraan Jalan.
- Persada, Citra. Sitorus, R P Santun. Marimin & Djakapermana, Ruchyat Denis. (2014). Penentuan Status Keberlanjutan Infrastruktur Perkotaan (Studi Kasus : Kota Bandarlampung). *Jurnal Sosek Pekerjaan Umum*. 6(1), 17-27.
- Persia, Luca & Friends. (2016). Management of Road Infrastructure Safety. *Transportation Research Procedia*. 14, 3436-3445.
- Prayitno,Budi.(2016).Skema Inovatif Penanganan Permukiman Kumuh.Yogyakarta.Gadjahmada University Press.
- Prisanto, Denny Eko. Yunawadi, Bagyo & Soemarno. (2015). Studi Pengelolaan IPAL (Instalasi Pengolahan Air Limbah) Domestik Komunal di Kota Blitar, Jawa Timur. *J-PAL*, 6(1), 74-80 .
- Pujiarman.(2016). Faktor-Faktor Keberhasilan Pengelolaan Infrastruktur Air Limbah Berbasis Masyarakat di Kabupaten Soppeng, Tesis,Institut Teknologi Sepuluh November, Surabaya.
- Suprayitno, Hitapriya & Soemitro, Ria Asih Aryani. (2018). Preliminary Reflexion on Basic Principle of Infrastructure Asset Management. *Jurnal Manajemen Aset Infrastruktur & Fasilitas*, 2(1), 1-10.
- Undang-Undang Republik Indonesia No. 38 Tahun 2004 tentang Jalan.

Feasibility Planning of Tuban Outer Ring Road Construction

1st Cahya Buana
Department of Civil Engineering
Sepuluh Nopember Institute of
Technology
Surabaya, Indonesia
cahya_b@ce.its.ac.id

2nd Alifia Az-Zahra
Department of Civil Engineering
Sepuluh Nopember Institute of
Technology
Surabaya, Indonesia
alifia14@mhs.ce.its.ac.id

3rd Catur Arif Prastyanto
Department of Civil Engineering
Sepuluh Nopember Institute of
Technology
Surabaya, Indonesia
catur_ap@ce.its.ac.id

4th Budi Rahardjo
Department of Civil Engineering
Sepuluh Nopember Institute of
Technology
Surabaya, Indonesia
rahardjo@ce.its.ac.id

Abstract— *In the document of East Java RTRW 2011 – 2031 shows a planning of strategic areas called golden triangle development, Tuban is in one of the triangle. Over time, vehicles passing through the city always use urban road which cause the heavy vehicle mixed with local traffic. One of the solutions is the construction of Tuban ring road (outer ring road). This final project will determine the alternative of Tuban ring road route to be more effective and analyze the feasibility of the selected alternative using the analytical hierarchy process method by interviewing with some experts. The result found that the alternative three is the chosen route. Saving the vehicle operational cost of this ring road construction reach Rp 270.118.152.562 and saving of time value reach Rp 101.560.399.789. All costs of the construction and land acquisition is Rp 799.629.618.714. Then the value of benefit cost ratio is $4,28 > 1$ and amount of net present value is Rp $2.705.937.413.332 > 0$. This study definitively answers that the construction of Tuban outer ring road with the chosen route is worthy for economic aspect.*

Keywords— *Tuban outer ring road, alternative route, analytical hierarchy process, time value, vehicle operational cost.*

I. INTRODUCTION

Tuban Regency is one of the area that is directed as the development of an industrial area in East Java. Industrial estates in Tuban are spread in several sub-districts named Soko, Rengel, Plumpang, Widang, Palang, Semanding, Jenu, Kerek, Tambakboyo and Bancar Districts. In Kerek Subdistrict there are Semen Indonesia and Holcim Cement factories. Furthermore, Jenu District is the most extensive industrial area in Tuban Regency, and one of the basic chemical industries in Jenu District has reached regional scale.

In regional scale Tuban Regency has strategic position because it is located in primary road of North Java, however this hasn't been used optimally. One of the reasons is because the development of road facilities grows slowly.

The road system in Tuban Regency only focus on one primary road that is belong to the province or country which pass through urban road of Tuban Regency, for instance Jl. Gajahmada which is connected the city center. This is turn the traffic condition in the city become uncomfortable and

unsafe because the traffic became mixed up as many heavy vehicles pass through intercity. And as result The heavy vehicles made traffic jam frequently occur even it wasn't at peak hours. This is the reason why the government of Tuban Regency plans on development of Tuban Regency's freeway and ring road.

The freeway will be used for connecting Gresik (manyar) – Tuban section, and Tuban – Demak section through Palang – Semanding – Merakurak – Kerek – Tambakboyo – Bancar and the gates will locate in Semanding, Merakurak, Kerek, and Bancar. In addition the ring-road will pass through Jenu – Tuban – Semanding – Palang subdistrict (Kabupaten Tuban, 2012) .

It's already decided that in total, the length of ring-road is 12.9km. This route still pass an incline in Tunah Village. This incline frequently become the reason for traffic jam in that area, because heavy vehicles has troubled while passing this route. The government was afraid because of this condition, it may have impacted the construction of the ring-road and the ring-road will be ineffective because of people who wants to continue their trip must pass through the incline. Therefore, this research will determine the alternative route of the effectiveness Tuban Regency ring road and analyze the feasibility of the chosen alternative.

II. LITERATURE REVIEW

A. Vehicle Capacity

Vehicle capacity is the maximum number of vehicles that can pass on given point during a specified period under prevailing road, traffic and control conditions. This equation can be used to determine vehicle capacity following the equation from PKJI 2014:

$$C = C_o \times FC_{LJ} \times FC_{PA} \times FC_{HS} \times FC_{UK} \quad (1)$$

Where:

- C = Road capacity (pce/hour).
- C_o = Stated capacity (pce/hour).
- FC_{LJ} = Carriageway width adjustment factor
- FC_{PA} = Directional split adjustmet factor
- FC_{HS} = Side friction and shoulder adjustment factor
- FC_{UK} = City size adjustment factor

B. Travel Time

Travel Time is the total time required by a vehicle to transverse a part of road. Value of travel time can be known based on the value of travel speed (V_T) to transverse a road segment is analyzed along the length of the road (L). Value of travel speed (V_T) derived PKJI 2014 diagram, as shown in Fig. 1. The calculation for determining travel time is :

$$T_T = \frac{L}{V_T} \tag{2}$$

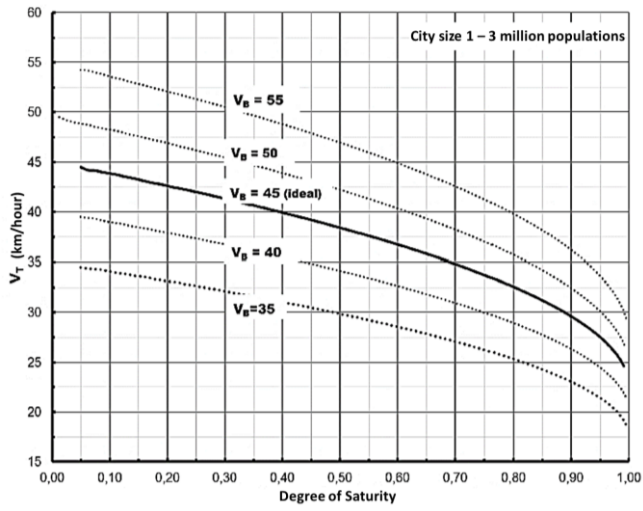

Fig. 1. Speed - Degree of Saturation Diagram (Ministry of Public Works, 2014)

Where:

T_T = Travel time of light vehicle (hour)

L = Length of the road (km)

V_T = Travel speed of light vehicle (kmh)

C. Analytical Hierarchy Process (AHP)

Analytic Hierarchy Process developed by Thomas L. Saaty also known as the AHP, is a method to determine the order of alternative decisions and selection of the best alternative. Each alternative will be rated using specific criteria by respondents, experts, therefore the selected alternative has the highest accumulative assessment based on the criteria (Saaty, 1987).

As the respondents has different perceptions of key performance indicator assessment, the alternative that will be chosen later is determined by respondents average rated. It also can lead to inconsistency answers given by respondents. Calculation of consistency values using formula from Saaty, it is proven that consistency index of the matrix with the order can be obtained by this following formula from Saaty.

$$CI = \frac{\lambda_{maximum} - n}{n - 1} \tag{3}$$

Where:

CI = Consistency index

λ_{MAX} = The maximum eigen value of matrix

The maximum eigen value (λ_{MAX}) derived from multiplying the number of columns with the main eigenvector. The matrices are consistent if the value of consistency index is zero. Limit of the acceptable consistency ratio is less or equal to 10%. Table 1 shows

random index value according to the matrix n order from Saaty.

$$CR = \frac{CI}{RI} \tag{4}$$

Where:

CR = Consistency ratio

CI = Consistency index

RI = Random index

TABLE I. RANDOM CONSISTENCY INDEX

n	1	2	3	4	5	6	7	8	9	10
RI	0	0	0,58	0,9	1,12	1,24	1,32	1,41	1,45	1,49

(Source: Paraskevopoulos, 1980)

D. Benefit Cost Ratio

One of parameter which show the feasibility of investment is Benefit Cost Ration (BCR) where this is used to comparing benefits of total cost that already converted to present value.

E. Net Present Value

Another parameter used to show the feasibility of investment is Net Present Value (NPV) where it will calculate the deviation between benefits and outcomes which converted to present currency. NPV is feasible if it has positive value ($NPV > 0$) whereas if the value is negative, the NPV is unfeasible.

III. METHODOLOGY

A. Problem Identification

In this part, the author will observe the actual condition in the field and the problem that happened there. Subsequently identify project location which will be passed by ring road, particularly along the area that passed through by the ring road.

B. Data Collection

There are two different kind of data that need to be collected, the first one is called primary data and the second one is secondary data. Primary data is obtained by direct information from surveying the field and/or interviewing experts. Their judgement are one of the data that will be used to determine the alternative. The result of interviewing experts will determine the values of each criteria. Therefore, interview will be conducted with regulator, executor, and independent institution. On the other hand, secondary data is obtained from existing studies. It consists data of vehicle volume, Gross Domestic Product (GDP), land use, and number of population.

C. Traffic Data Analysis

The analysis is a part where all the data will be process by analyze the comparison of the existing road before and after the project. GDP data needed for forecasting the number of light vehicles and heavy vehicles. The number of vehicles in a given year is determined not only by current income, but also by past income (Dargay & Gately, 2001)

D. Determining Chosen Alternative Route

There will be three alternative routes in the planning, interview with experts is needed to determine the best alternative and then analyzed by using analytical hierarchy process (AHP) method.

E. Economic Feasibility Analysis

One way to find out whether a project feasible or not is by calculate the economic feasibility of the project. Using benefit cost ratio and net present value method to calculate its feasibility. Benefit cost has been called the “single most important problem-solving tool in policy work” (Munger, 2000).

F. Conclusion

In conclusion, the result of processing existing data will obtain the best alternative route for ring road and in addition also obtained result of the feasibility calculation.

IV. ANALYSIS AND RESULT

A. Traffic Data Analysis

Traffic counting data by the Department of Transportation of Tuban Regency will be used for several analyzes, vehicle capacity, vehicle volume, and degree of saturation. The value of vehicle capacity and the degree of saturation of each existing road are as follows:

TABLE II. VEHICLE CAPACITY OF EXISTING ROAD

Road Name	C ₀ (pce/hour)	FC _L	FC _{PA}	FC _{HS}	FC _{UK}	Road Capacity (pce/hour)
Raya Semarang	2900	1,29	1	0,92	1	3442
Raya Tuban – Sedayu	2900	1,29	0,94	0,96	1	3376
Manunggal	2900	1,25	0,76	0,86	1	2369
Raya Tuban – Babat	2900	1,29	1	0,96	1	3591
Gajahmada	2900	1,34	0,97	0,82	1	3091

TABLE III. DEGREE OF SATURITY OF EXISTING ROAD

Road Name	Q (pce/hour)	C (pce/hour)	Degree of Saturity
Raya Semarang	3674	3442	1,07
Raya Tuban – Sedayu	1518	3376	0,45
Manunggal	846	2369	0,36
Raya Tuban – Babat	1801	3591	0,5
Gajahmada	4599	3091	1,49

Error! Reference source not found. shows degree of saturation of existing roads. Raya Semarang and Gajahmada is already saturated ($D_s > 1$). While for Raya Tuban – Sedayu, Manunggal and Raya Tuban – Babat will be saturated. Furthermore, a traffic growth analysis was conducted using Tuban Regency Gross Domestic Product (GDP). Data obtained from the annual publication issued by the central bureau of Tuban Regency. Meanwhile, for forecasting the number of motorbikes is used GDP capita. The GDP data presented in Fig. 2. In **Error! Reference source not found.** represents results of the average growth percentage of GDP is 5,5% and GDP per capita is 4,9%. The data will be used to forecast of traffic volume 25 years ahead of existing road.

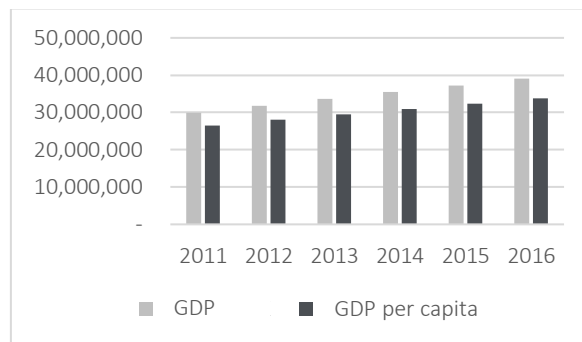

Fig. 1. Tuban Regency Gross Regional Domestic Product (Source: BPS Kab. Tuban, 2017)

TABLE IV. GDP AND GDP PER CAPITTA GROWTH

Year	Percentage (%)	
	GDP	GDP per capita
2011 - 2012	6,287	5,659
2012 - 2013	5,854	5,213
2013 - 2014	5,467	4,952
2014 - 2015	4,888	4,358
2015 - 2016	4,900	4,404
Average :	5,5%	4,9%

B. Road Selection Analysis

Multi criteria analysis method is used to determine the chosen ring road route. The indicator used in the selection of ring road route in Tuban Regency are road length, number of turning path, intersections, topographic condition, passed region area, existing condition route. Alternative ring road route as shown in Fig. 3, Fig. 4 and Fig. 5.

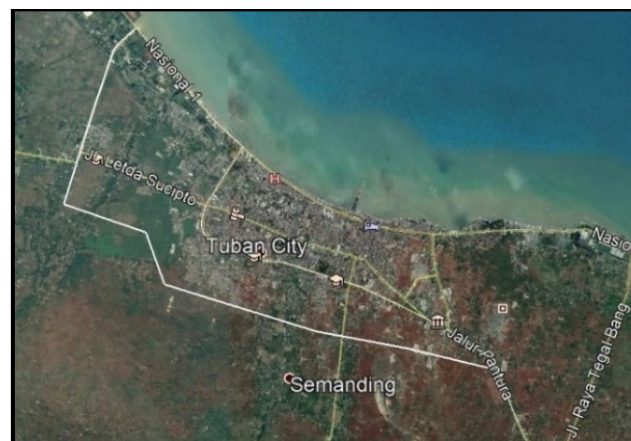

Fig. 3. Alternative 1 Ring Road Route

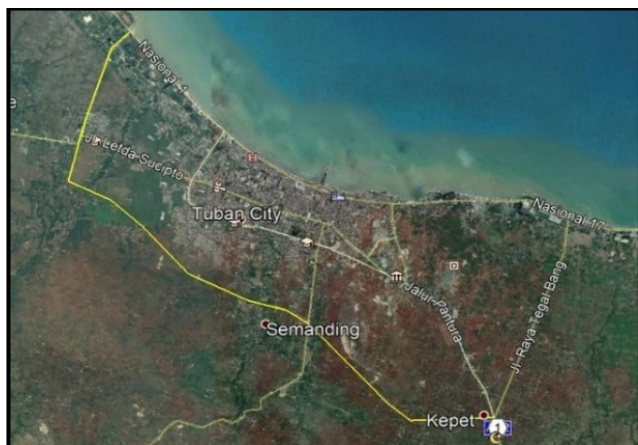

Fig. 4. Alternative 2 Ring Road Route

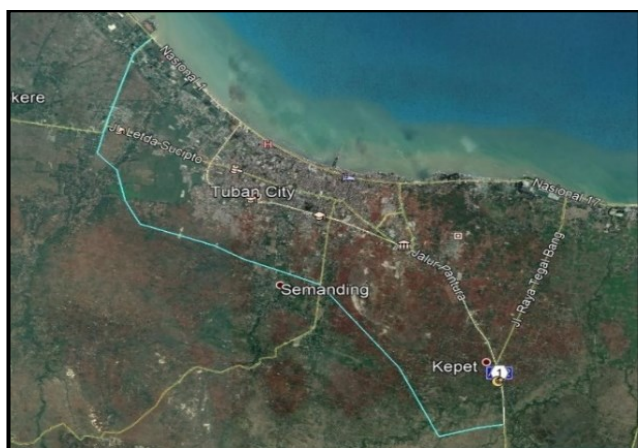

Fig. 5. Alternative 3 Ring Road Route

Scale selection of chosen route based on the criteria that have been set. Initial step in this method is arrangement of hierarchial structure, then main survey by stated preference questionnaire each respondent take apart in determination. There are three type of respondents in this case, regulator as the part that regulates all regional interest, executor as part of implementing construction of the ring road, and independent part (academics). Hierarchy structure in the selection for ring road route presented in Fig. 6.

The questionnaire which used in selection route is a pairwise comparison matrix, a matrix that compare several criteria as a key performance index, the weight value of each criterion are obtained (Saepudin, Abdillah, & Yuniarti, 2017)

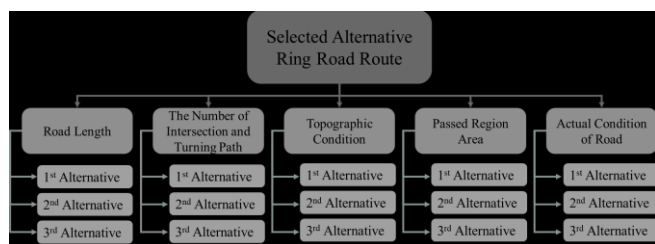

Fig. 6. Hierarchy Structure for AHP

The respondents also compared every alternative route based on all criteria. Afterwards calculating eigenvector of matrix to determine weighted and ranked criteria. To calculate the eigenvector begins by normalizing matrix, then

calculate number of each row and divide by the number of orders ($n=5$), therefore the weight value is obtained. The final step is calculating consistency ratio.

Interviewed respondents in this case was eight experts. There were three respondents who had consistency ratio more than 10%, so that the data provided by those three respondents not acceptable, Table V. Five out of eight respondents with accepted data, two respondents chose alternative 3, two respondents chose alternative 2 and one respondents chose alternative 1 as shown in Table VI. The alternative 3 becomes the best alternative selection and was used in next analysis.

TABLE V. CONSISTENCY RATIO FROM RESPONDENTS

Respondents	Consistency ratio of					
	All Criteria	RL	ITP	TC	PRA	ACR
A	0,0986	0,061	0,061	0,061	0,056	0,056
B	0,058	0,052	0,052	0,056	0,052	0,056
C	0,032	0,037	0,000	0,048	0,059	0,022
D	0,087	0,061	0,000	0,000	0,000	0,000
E	0,0987	0,061	0,061	0,056	0,056	0,000
F	0,731*	0,087	2,201*	0,048	1,394*	0,087
G	0,544*	0,401*	0,401*	0,000	0,401*	0,401*
H	0,391*	0,061	0,061	0,056	0,056	0,056

Where :

- RL = Road length
- ITP = The number of intersection and turning path
- TC = Topographic condition
- PRA = Passed region area
- ACR = Actual condition of road
- * = Consistency ratio more than 10%

TABLE VI. WEIGHTED VALUE OF EVERY ALTERNATIVE ROUTE

Respondents	Weighted Value of Alternative		
	1	2	3
A	0,158	0,477	0,365
B	0,241	0,347	0,412
C	0,319	0,278	0,404
D	0,541	0,251	0,209
E	0,179	0,419	0,402

C. Trip Assignment Analysis

Trip Assignment is one of transportation modeling phases

to predict the percentage of vehicle displacement from existing road to ring road. The purpose of trip assignment is to know the amount of car flow and or total traveling in observed road network (Kela, 2013). Calculation of Trip Assignment is using SMOCK 1962 method for existing road

and choosing ring road alternative. The chosen road segment which will be observe is Jalan Raya Tuban – Babat and Jalan Raya Semarang. The maximum volume of vehicle in Jalan Raya Tuban – Babat is 1880 light vehicle unit per hour. Meanwhile for Jalan Raya Semarang, the amount of vehicle is 3674 light vehicle unit per hour. Then results of trip assignment is 60% of vehicles on Jalan Raya Tuban-Babat will move to the ring road, in addition 59.09% of vehicles on Jalan Raya Semarang will also move to the ring road.

D. Vehicle Operational Cost Analysis

In terms of economy, in order to find out the benefits after the ring road construction is by measuring the value of the vehicle operating costs savings. Vehicle operational cost savings are obtained from the difference in value of the Vehicle Operational Cost before the construction of the ring road and after the construction of the ring road. This research will find the calculation of vehicle operational costs using the Jasa Marga method for five categories and the NDLEA method to calculate the motorcycle operational cost.

E. Time Value Analysis

Basically, time value is a travel time saving which assessed economically. The time value is related to the amount of money someone has spent (or saved) to save one unit of travel time (Tamin, 1999). The equation to calculate time value is: $Max \{K * Basic \ Time \ Value\}$; Minimum Time Value. The inflation used for this research is based on March 2018 of 3.4%, which obtained from the official website of Bank Indonesia. The inflation is used to calculate the predicted time value for the next 25 years. Then the time value is multiplied by travel time to get the time value for one year.

F. Economic Feasibility Evaluation

The result of the economic feasibility of the ring road is generally obtained by comparing between benefits and expenses. Broadly speaking, there are two results from analysis of benefits or advantages, namely direct benefit and indirect benefit. The direct benefit is a benefit for driver/passenger. The driver and/or passenger will get comfort and safety on their trip because of better access. It will reduce vehicle operational costs and transportation costs will be cheaper. From vehicle operational costs calculation, it results that Tuban Regency ring road save Rp. 270,118,152,262 in 2045.

Additionally, indirect benefit is related to Improvements in travel time which then will affect the reduction in travel costs and benefits of saving the time value of road users. Then, from the calculation of time value obtained time value saving from the construction of the Tuban ring road that reached to Rp 101,560,399,789 in 2029.

Calculation of economic benefits is used to determine feasibility whether the construction of the ring road Tuban Regency to be built based on the economic value of road users. This research will analyze using the method of Benefit Cost Ratio (BCR) and Net Present Value (NPV), with interest rate of 4.46% from Bank Indonesia 7-Day Repo Rate. Here is calculation of economic analysis:

Total Cost	= Rp 799.629.618.714
Present Worth Cost	= Rp 825.092.675.804
Present Cost Benefit	= Rp 3.531.030.089.136
Benefit Cost Ratio	= $\frac{Rp\ 799.629.618.714}{Rp\ 3.531.030.089.136} = 4.28 > 1 \dots (ok)$

$$Net\ Present\ Value = Rp\ 3.531.030.089.136 - Rp\ 825.092.675.804 = Rp\ 2.705.937.413.332 > 0 \dots (ok)$$

So, the construction project of Ring Road in Tuban Regency is said to be "WORTH" in terms of the economy. In addition to direct benefits that obtained directly by the people who pass through the ring road, there are also indirect benefits of the construction of a new road network. Some of the indirect benefits include increased land prices and production, ease to transport the production so that it can also affect the reduction of transportation costs on production.

V. CONCLUSION

To conclude, results of the analysis of traffic in Tuban Regency, Jalan Semarang and Jalan Gajahmada segments have reached saturation point. The construction of the ring road in Tuban Regency is further step to overcome this problem. The results of the expert judgment assessment at the Analytic Hierarchy Process stage were obtained from the number of respondents of eight people, there were three respondents who had a CR value > 10%, so the data provided by the three respondents was not acceptable. From the data that have been received and processed, alternative 3 becomes the best alternative selection. In the first year, the savings for Vehicel Operational Cost (VOC) amounted to Rp 127,531,563,254 and reached Rp 270,118,152,562 at the end of the planning year. Time value savings for the first year amounted to Rp. 44,787,188,416, reaching Rp. 101,560,399,789 in the 9th year. Based on the results of economic feasibility analysis, the value of Benefit Cost Ratio was 4.28 (BCR > 1) and the Net Present Value was Rp. 2,705,937,413 .332 (NPV > 0). So, the construction of the ring road in Tuban Regency with the selected route was declared feasible in terms of the economy.

REFERENCES

BPS Kab. Tuban. (2017). Tuban Regency in Figures 2017, 254.
 Dargay, J., & Gately, D. (2001). Modelling Global Vehicle Ownership. In *Proceedings of the Ninth World Conference on Transport Research Society* (pp. 1–21).
 Kabupaten Tuban. (2012). *Rencana Tata Ruang dan Wilayah Kabupaten Tuban Tahun 2012-2032*. Tuban.
 Kela, M. B. (2013). Analisis Pembebanan Jaringan Jalan (Trip Assignment) pada Koridor Malang - Surabaya. *Widya Teknika*, 21(2), 27–31.
 Ministry of Public Works. (2014). *Pedoman Kapasitas Jalan Perkotaan*.
 Munger, M. C. (2000). *Analyzing policy: choices, conflict and practices* (First Edit). Washington D.C.: W. W. Norton & Company.
 Paraskevopoulos, K. (1980). The Analytic Hierarchy Process. Greece: International Hellenic University. Retrieved from http://rad.ihu.edu.gr/fileadmin/labsfiles/decision_support_systems/lessons/ahp/AHP_Lesson_1.pdf
 Saaty, R. W. (1987). The Analytical Hierarchy Process- What and Why it is Used. *Mathematical Modelling*, 9(3), 161–176. [https://doi.org/https://doi.org/10.1016/0270-0255\(87\)90473-8](https://doi.org/https://doi.org/10.1016/0270-0255(87)90473-8)
 Saepudin, M., Abdillah, G., & Yuniarti, R. (2017). Sistem Pendukung Keputusan Menentukan Kelayakan Pengangkatan Karyawan Tetap Menggunakan Metode Analytic Hierarchy Process dan Weighted Product. *Seminar Nasional Teknologi Informasi Dan Multimedia*, 43–48.
 Tamin, O. Z. (1999). *Perencanaan dan Pemodelan Transportasi* (Second). Bandung: ITB.

Land Acquisition Cost	= Rp 249.000.000.000
Road Construction	= Rp 550.629.618.714 +

Transparency and Accountability Public Sector Procurement for Infrastructure in Indonesia: A Literature Review

1st Dewi Yustiarini

Civil Engineering Doctoral Study
Program/ Civil Engineering Education
Department
Institut Teknologi Bandung/Universitas
Pendidikan Indonesia
Bandung, Indonesia
dewiyustiarini@gmail.com
<https://orcid.org/0000-0003-2345-3881>

2nd Biemo W. Soermardi

Civil Engineering Department
Institut Teknologi Bandung
Bandung, Indonesia

3rd Krishna S. Pribadi

Civil Engineering Department
Institut Teknologi Bandung
Bandung, Indonesia

4th Iris Mahani

Civil Engineering Department
Institut Teknologi Bandung
Bandung, Indonesia

5th Muhammad Farhan Setyawan

Civil Engineering Magister Study
Program
Institut Teknologi Bandung
Bandung, Indonesia

Abstract— *Transparency and accountability are two principles that need to be prioritized to realize good governance. Both of these principles have a close and mutually supportive relationship. Without transparency, there will be no accountability and without accountability, transparency means nothing. Identify problems that transparency and accountability are found in many previous studies in the field of law and public administration not in infrastructure. Formulation of the problem of how to implement transparency and accountability in the infrastructure sector. This study aims to find patterns of transparency and accountability in public infrastructure in Indonesia based on applicable law as a review of the literature. Collection of secondary data from legislation, national journals, and books related to transparency and accountability. The results of the study found that the main actors for good governance are public agency. The public agency is responsible for providing information disclosure including matters of transparency and accountability. The infrastructure sector has a Construction Services Law which provides guidance on the application of transparency and accountability in the field of public infrastructure. The results of the study are presented in the form of patterns / images of transparency and accountability in the field of public infrastructure.*

Keywords— *transparency, accountability, infrastructure*

I. INTRODUCTION

Infrastructure development is currently a major concern of the Government of Indonesia. The infrastructure budget continues to be increased year by year. Referring to the Ministry of Finance data (Erwin, 2019) for 2019, the Government has budgeted IDR 415 trillion. This figure has increased by 1,04 percent from the 2018 budget. Previously, respectively since 2015 rose 65.5 percent, 2016 increased 5,1 percent. Then in 2017 it increased by 44,3 percent, and in 2018 it grew 5,8 percent. According to the President (quoted from Kompas online, Dani, 2018), the goal of infrastructure development is to make the economy more efficient and competitive and also unite the nation to open up new economic opportunities for the people (Dani, 2018). According to Teuku Faisal (quoted from Kompas online, Fajar, 2016), infrastructure that is built should not be originated quickly or as long as possible, the Government also needs to pay attention

to accountability and transparency of infrastructure projects. Therefore, the Government needs to develop regulations that support efforts to maintain accountability and transparency in infrastructure development. (Fajar, 2016).

Transparency is synonymous with openness while accountability is identical to the clarity of management accountability. Traced from legislation, transparency and accountability are written in Law Number 14 of 2008 concerning Public Information Openness or often abbreviated as UU-KIP. Based on the UU-KIP, transparency is openness in carrying out the decision-making process and openness in presenting material and relevant information about the company. Accountability is the clarity of the functions, implementation, and accountability of company organizations so that company management is carried out effectively.

Public information openness (KIP) is one of the important characteristic of a democratic country that upholds people's sovereignty to realize a good state administration. Public information disclosure is a means of optimizing public oversight of the administration of other public agency and everything that has a public interest. Management of public information is an effort to develop an information society. In general, the UU-KIP Number 14 of 2008 can guarantee and protect Indonesia's human rights in the field of communication and information, which is also a form of welfare for the people.

According to Mas Achmad Santosa quoted by Nunuk (2012), good governance requires open government as one of its foundations. In the UNDP report (quoted by Nunuk, 2012), some characteristic of the implementation of UNDP provide several characteristic of the implementation of good governance, including: rule of law participation, transparency, responsiveness, consensus orientation, equity, efficiency and effectiveness, accountability and strategic vision. According to Article 3 of the UU-KIP, this Law aims to encourage public participation in the policy-making process, as well as to realize good state administration, namely transparent, effective and efficient, accountable and accountable. In Article 14 of the UU-KIP, it is also stated that the guidelines for implementing good corporate governance are based on the principles of

transparency, accountability, accountability, independence, and fairness.

Based on the results of previous research, there have not been many findings regarding transparency and accountability in the infrastructure sector. This is assumed because of transparency and accountability related to public agency so that more discussion in the field of law and public administration. Opportunities were found to examine transparency and accountability in the infrastructure sector using library research to obtain secondary data. Formulation of the problem of how to implement transparency and accountability in the infrastructure sector. This study aims to find patterns of transparency and accountability in the public infrastructure sector in Indonesia based on applicable law as a literature review.

The method of approach used in this study is normative legal research. Normative legal research is in the form of library research to obtain data in the form of legal documents in the form of laws and regulations, ministerial decrees, journals, papers, and books relating to the subject matter under study. Library research is intended to obtain secondary data, in the form of legal materials which include:

1. Primary legal materials, laws and regulations that apply in Indonesia related to this writing include UU-KIP, UUKJ, and other laws and regulations as comparative material in this writing.
2. Secondary legal materials, namely legal materials that provide further explanation on primary legal material. Secondary legal materials used in this study are secondary legal materials consisting of journals, articles, pre-existing research reports, the internet, and various scientific publications, and references relating to the problems studied.
3. Tertiary legal materials, namely materials that provide instructions and explanations for primary and secondary legal materials including legal dictionaries, Indonesian dictionaries, handbooks and so on that have relevance to research problems.

The specification of this study is descriptive analytical, which describes the applicable regulations such as UU-KIP, UUKJ, and then analyzed legally in accordance with the development of applicable law. Data analysis is done qualitatively normatively, which describes the sentences so that systematic discussion or exposure can be obtained so that it is easily understood and used to conduct analysis by reviewing research results based on theories and legal documents. With this analysis it is expected that in the end it can reveal the problems that occur in detail and produce a conclusion.

II. LEGAL ASPECTS OF TRANSPARENCY AND ACCOUNTABILITY IN NON-CONSTRUCTION SERVICES IN INDONESIA

A. Law No. 14 of 2008 concerning Public Information Openness

Every Public Agency has an obligation to open access to Public Information relating to the Public Agency for the wider community. The scope of the Public Agency in this Law includes executive, judicial, legislative, and other state

administrators who obtain funds from the State Budget (APBN)/Regional Budget (APBD) and include non-governmental organizations, both agency-based legal and non-legal entities, such as non-governmental organizations, associations, and other organizations that manage or use funds that are partly or wholly sourced from the APBN/APBD, donations from the public, and / or abroad. Through the mechanism and implementation of the principle of openness, good governance and transparent community participation and high accountability will be created as one of the prerequisites for realizing essential democracy. By opening public access to information, it is hoped that the Public Agency will be motivated to be responsible and oriented towards the best public service. Thus, it can accelerate the realization of open government which is a strategic effort to prevent the practice of corruption, collusion and nepotism (KKN), and the creation of good governance.

Article 1 of the UU-KIP, Paragraph (2) Public Information is information that is produced, stored, managed, sent, and/or received by a public agency relating to the organizer and administration of the state and/or the organizer and organization of other public agency in accordance with Law and other information relating to the public interest. Article 1 of the UU-KIP, Paragraph (3) Public agency are executive, legislative, judicial and other agency whose functions and main tasks are related to the administration of the state, in part or all of their funds sourced from the State Revenue and Expenditure Budget and/or Revenue Budget and Regional Expenditures, or non-governmental organizations as long as part or all of their funds are sourced from the State Revenue and Expenditure Budget and/or Regional Revenue and Expenditure Budget, donations from the public, and/or abroad. Article 1 of the KIP Law Paragraph (11) Public Information Users are people who use public information as stipulated in the Law.

Article 2 UU-KIP Paragraph (1) Every Public Information is open and can be accessed by every User of Public Information. Paragraph (2) Excluded Public Information is strict and limited. Paragraph (3) Every Public Information must be obtained by every Public Information Applicant quickly and in a timely, light, and simple manner. Paragraph (4) Public information that is excluded is confidential in accordance with the Law, propriety, and public interest is based on a test of the consequences that arise when an information is given to the public and after careful consideration that closing Public Information can protect interests greater than open it or vice versa.

UU-KIP aims to guarantee the right of citizens to know about plans for public policy making, public policy program, and public decision-making processes, as well as the reasons for making public decisions; and encourage public participation in the public policy making process. The next objective is to increase the active role of the community in public policy making and good management of Public Agency; realizing good state administration, namely transparent, effective and efficient, accountable and answerable; and knowing the reasons for public policies that affect the lives of many people. And develop science and educate the life of the nation; and/or improve information management and services within the Public Agency to produce quality information services.

In the UU-KIP, there are things and obligations of public information users including the rights and obligations of public agency. In Article 4 of the UU-KIP, each person has the right to obtain Public Information in accordance with the provisions of the Law, namely: seeing and knowing Public Information; attend public meetings that are open to the public to obtain Public Information; get a copy of Public Information through an application in accordance with this Law; disseminate Public Information in accordance with laws and regulations. While the obligation as a user of public information, must use Public Information in accordance with the provisions of legislation and include the source of origin of public information obtained.

UU-KIP regulates information that must be provided and announced periodically, immediately, and information that must be available at any time. Article 9 UU-KIP public agency are required to announce public information on a regular basis, which consists of: information relating to Public Agency; information about the activities and performance of the relevant Public Agency; information about financial statements; and/or other information stipulated in the laws and regulations. This obligation is carried out at least six months. Article 10 UU-KIP public agency must announce immediately information that can threaten the lives of many people and public order. Article 11 UU-KIP public agency must provide public information at any time, which includes: a list of all Public Information under their control, excluding excluded information; results of decisions of Public Agency and their considerations; all existing policies and supporting documents; the project work plan includes the estimated annual expenditure of the Public Agency; Public Agency agreement with third parties; information and policies submitted by Public Officials in meetings that are open to the public; Public Agency employee work procedures relating to community service; and/or report on services to access Public Information as stipulated in this Law. If there is information that is rejected, it is necessary to be informed of the reasons for the refusal (Article 12, UU-KIP).

Based on Article 13 of the UU-KIP, the public agency needs to appoint an Information and Documentation Management Officer (PPID) and create and develop a system of providing information services quickly, easily, and fairly in accordance with the National Information Service standards technical guidelines that apply nationally. Article 17 of the UU-KIP concerning excluded information. every public agency is obliged to open access for every applicant for public information to obtain public information, except: Public Information which if opened and given to Public Information Applicants can hamper the law enforcement process, can disrupt the interests of intellectual property rights protection and protection from unfair business competition ; may endanger national defense and security; can reveal Indonesia's natural wealth; can harm the resilience of the national economy; may harm the interests of foreign relations; may disclose the contents of authentic deeds that are personal and final wishes or one's will; can reveal personal secrets; Memorandum or letters between public agency or intra public agency, which by their nature are kept confidential except for the decisions of the Information Commission or court; and information that may not be disclosed based on the Law.

Article 18 of the UU-KIP describes information that is not included in the category of excluded information, namely:

Decision of the judicial agency; Decisions, provision, regulations, circulars, or other forms of policy, whether those that do not apply are binding or binding both inside and outside and the consideration of law enforcement agencies; Warrant for termination of investigation or prosecution; Planned annual expenditure of law enforcement agencies; Annual financial statements of law enforcement agencies; Reports on the results of the return of money resulting from corruption; and / or other information as referred to in Article 11 paragraph (2).

B. Government Regulation No. 61 of 2010 concerning the Implementation of the UU-KIP

To implement the provisions of Article 20 paragraph (2) and Article 58 of Law Number 14 of 2008 concerning Public Information Openness, Government Regulations concerning the Implementation of Law Number 14 Year 2008 concerning Public Information Disclosure are stipulated. The Government stipulates Government Regulation Number 61 of 2010 concerning the implementation of Law Number 14 of 2008 concerning Public Information Openness. Article 1 paragraph (5) describes the explanation of the Information and Documentation Management Officer, hereinafter abbreviated as PPID, is an official responsible for the storage, documentation, provision and/or service of information in a Public Agency. Furthermore, in paragraph 7, Excluded Information is information that cannot be accessed by the Public Information Applicant as referred to in the Law on Public Information Disclosure. Classification of Public Information is the determination of information as Information Excluded under the Law on Public Information Openness.

In Article 2 of the UU-KIP, regarding the request for Public Information by the Public Information Applicant, the Public Agency is obliged to make written considerations on every policy taken to fulfill the rights of each Public Information Applicant. Written considerations are determined by the PPID with the approval of the leadership of the relevant Public Agency. Article 3 Classification UU-KIP Information is determined by the PPID in each Public Agency based on the Consciousness Test carefully and thoroughly before stating that certain Public Information is excluded to be accessed by everyone. Determination of Information Classification is done with the approval of the relevant Public Agency leadership.

C. Information Commission Regulation Number 1 of 2010 concerning Public Information Service Standards

Article 23 UU-KIP concerning information commission The Information Commission is an independent institution that functions to carry out the Laws and implementing regulations establishing standard technical guidelines for Public Information services and resolving Public Information Disputes through Mediation and/or Non-litigation Adjudication. Article 2 The Information Commission Regulation aims to provide standards for Public Agency in carrying out public information services; improve public information services within the Public Agency to produce quality Public Information services. Another goal is to guarantee the fulfillment of citizens' rights to obtain access to Public Information; and guarantee the realization of the purpose of the implementation of information disclosure as stipulated in the Public Information Openness Law.

Article 6 Information Commission Regulations regarding PPID responsibilities and authorities in the field of Public Information services include the process of storing, documenting, providing and providing Public Information. Article 7 of the Information Commission Regulation, PPID is responsible for coordinating the storage and documentation of all Public Information that is in a Public Agency. The PPID is responsible for coordinating the collection of all public information physically from each unit / work unit which includes:

- a. information that must be provided and announced periodically;
- b. information that must be available at any time;
- c. other open information requested by the Public Information Applicant.

III. LEGAL ASPECTS OF TRANSPARENCY AND ACCOUNTABILITY OF CONSTRUCTION SERVICES IN INDONESIA

A. Circular of the Minister of Public Works No. 4 of 2014

In order to realize rights and information, the Government has issued Law Number 14 of 2008 concerning Public Information Openness (UU-KIP) and Government Regulation Number 61 of 2010 concerning Implementation of Law Number 14 of 2008 concerning Public Information Openness. This set of rules guarantees individuals and legal entities to obtain needed public information from public agency. These legislation provides an opportunity for public participation in the administration of the State, which in turn can encourage the realization of a transparent, effective, efficient and accountable State administration.

The Ministry of Public Works as a Public Agency that has strategic needs in the administration of government, especially the provision of infrastructure in the field of public works, is obliged to implement public information disclosure in order to realize good governance. In an effort to implement the UU-KIP and its implementing regulations, as well as to realize effective and efficient public information services, the Operational Standards for Public Information Management and Service Procedures are set forth in the Ministry of Public Works in the Minister of Public Works Circular Number 4 of 2014. This circular is intended as a reference for each Ministry of Public Works organizational unit in the management and service of public information carried out by the Information and Documentation Management Officer (PPID). This circular letter aims to enable every organizational unit in the Ministry of Public Works to be able to provide, collect, document, and deliver public information accurately, quickly, and easily.

Organizational Units are the organizational elements of the Ministry of Public Works. Work Units are organizational elements of the Ministry of Public Works which consist of work units in each organizational unit. Technical Implementation Unit (UPT) is an independent organization that carries out certain operational technical tasks and/or certain technical support tasks from its parent organization. Technical Executing Units in the Ministry of Public Works in the form of Big Office. The Ministry of Public Works organizational unit consists of:

- a. Secretariat General;

- b. Inspectorate General;
- c. Directorate General of Water Resources;
- d. Directorate General of Highways;
- e. Directorate General of Human Settlements;
- f. Directorate General of Spatial Planning;
- g. Construction Guidance Agency;
- h. Research and Development Agency;
- i. Toll Road Regulatory Agency;
- j. Supporting Agency for the Development of Water Supply Systems.

To serve public information requests, the PPID Ministry of Public Works provides a Public Information Service Room on the ground floor of the main building of the Ministry of Public Works. The Public Information Service Room is equipped with an information desk, a clean and comfortable waiting room, a computer, internet, telephone, fax, information shelves that contain various kinds of books and media for public information. Meanwhile for Work Units and Technical Implementation Units as Supporting Teams provide information desks as information services. Service Products prepared by the Ministry of Public Works PPID, consisting of:

1. Public information service products (except excluded information), in the form of hardcopy (books/magazines/brochures/prints/photocopies) and softcopy (data in files).
2. In the event that public information requested by the applicant is available on the website of the Ministry of Public Works, applicants can download and print it themselves from the website of the Ministry of Public Works.

Keep your text and graphic files separate until after the text has been formatted and styled. Do not use hard tabs, and limit use of hard returns to only one return at the end of a paragraph. Do not add any kind of pagination anywhere in the paper. Do not number text heads-the template will do that for you.

B. Minister of PUPR Decree No. 450 of 2017

Decree of the Minister of Public Works and Public Housing Number 450/KPTS/M/2017 concerning the list of information that must be provided and announced at the Ministry of Public Works and Public Housing, considering Law Number 14 Year 2008, Government Regulation Number 61 of 2010, Information Commission Regulation Number 1 of 2010, and amending Decree of the Minister of Public Works Number 391/KPTS/M/2011 concerning Determination of Information Classification at the Ministry of Public Works of the Republic of Indonesia which is no longer in line with the development of legal and organizational structure of the Ministry of Public Works and Public Housing (PUPR) New Minister. A list of information that must be provided and announced is listed in the Appendix which is an integral part of this Ministerial Decree. The Organizational Unit within the Ministry of PUPR that provides a list of information consists of the Secretariat General, Inspectorate General, Directorate General of Water Resources, Directorate General of Highways, Directorate General of Human Settlements, Directorate General of Housing, Directorate General of

Housing Financing, Research and Development Agency, Directorate General Construction Management, Water Resources Development Agency, Regional Infrastructure Development Agency, Toll Road Regulatory Agency, and supporting Agency for the Development of Drinking Water Supply Systems. Ministerial Decree No. 450 of 2017 stipulates a list of information that must be provided and announced at the Ministry of Public Works and Public Housing, including:

- a. Public information that must be provided and announced periodically.
- b. Public information that must be announced immediately.
- c. Public information that must be available at any time.

The list of information that must be provided and announced at the Ministry of PUPR of the Republic of Indonesia is divided into two parts, namely general information and special information. General information is information that must be provided and announced periodically by all organizational units. Regarding the information announced consists of:

1. Work Unit Profile.
2. List of structural and / or functional officials.
3. General information on the procurement of goods and services (e-procurement).
4. Announcement of the auction of goods and services.
5. Summary of Ministry Financial Reports (Budget Realization and Audited Balance Sheet reports).
6. Summary of access reports (public information services).
7. Information about the agenda, activities that have been, are being carried out, and will be carried out.
8. Publication and documentation of PUPR activities (Journal, Bulletin, Brochure, website reporting, press release).

General information that must be available at all times by all organizational units, consisting of:

1. Work Leadership Agenda and Echelon I Official.
2. Information on organization statistics, administration, staffing and finance.
3. Information about public service procedures / procedures.
4. Legal products within the scope of the Ministry of PUPR's duties.
5. List and document of agreement / MoU other than agreements / contracts for procurement of goods and services.
6. Profile of infrastructure in the PUPR sector.

General information that must be announced by all organizational units immediately, consisting of:

1. Information about damage to PUPR infrastructure due to natural disasters.
2. Information about functional functional plans for public utilities.
3. Information on disaster emergency response progress.

List of information that must be provided and announced specifically by organizational units related to public information on the construction, among others:

1. Procedures for obtaining public information, filing objections and information dispute resolution processes. Information that must be provided and announced periodically by the organizational unit of the Secretariat General.
2. Map of Indonesia's infrastructure and List of Public Information. Information that must be available at all times by the organizational unit of the Secretariat General.
3. Public complaints procedures. Information that must be provided and announced periodically by the organizational unit of the Inspectorate General (Irjen).
4. Priority programs of the Directorate General of Water Resources (Ditjen SDA) and a list of reservoir water levels. Information that must be available at all times by the Ditjen SDA organizational unit.
5. General information on road conditions and priority programs of the General Directorate of Highways. Information that must be provided and announced periodically by the organizational unit of the Directorate General of Highways.
6. General information on housing finance assistance mechanisms. Information that must be provided and announced periodically by the organizational unit of the Directorate General of Housing Financing.
7. Application/Information system results of Research and Development. Information that must be available at all times by the Research and Development Agency (Balitbang) organizational unit.
8. Market data on domestic and foreign infrastructure, list of priority projects, and list of information on the progress of package construction project work at the provincial level, and list of auction winners in the PUPR sector (Job value > 100 M). Information that must be provided and announced periodically by the organizational unit of the Directorate General of Construction.

The procedure for obtaining public information is information that must be provided and announced periodically by the Organizational Unit of the Secretariat General. For a list of priority projects, namely projects carried out by the Government, Regional Government and or Business Entities that have a strategic nature to increase growth and even distribution of regional development, information must be provided and announced periodically by the Directorate General of Construction.

C. Law Number 2 of 2017

The construction service sector is a community activity to realize a building that functions as a support or infrastructure for social economic activities to support the realization of national development goals. The implementation of construction services needs to ensure order and legal certainty. Law Number 18 of 1999 concerning Construction Services has not been able to meet the demands of good governance needs and the dynamics of the development of the

implementation of construction services, so Law Number 2 of 2017 concerning Construction Services is issued.

In Article 2 of the Law on Construction Services (UUJK), the Implementation of Construction Services is based on one of them on the principle of openness. What is meant by the principle of openness is that the availability of information can be accessed by the parties so that the realization of transparency in the implementation of Construction Services enables parties to carry out their obligations optimally, obtain certainty of their rights, and make corrections so that there are shortcomings and deviations (Article 2, letter h). Transparency in the Construction Services Law written in Article 4 paragraph (1) concerning the responsibilities of the Central Government:

- a. Increase in the capacity and capacity of the national Construction Services business;
- b. Creating a conducive business climate, providing transparent Construction Services, fair business competition, and guaranteeing equality of rights and obligations between Service Users and Service Providers;

The implementation of Construction Services is specifically written in Chapter 5 UUJK which consists of 4 parts, consisting of general parts, construction services binding section, construction service management section, and building supply agreement section. In the service binding section, there is an explanation of the Selection of Service Providers with funding sources from the State finances by means of tendering or selection, electronic procurement, direct appointment, and direct procurement in accordance with the provisions of the legislation.

D. Presidential Regulation Number 16 of 2018

Previously there was a Presidential Regulation Number 54 of 2010 concerning the procurement of Government goods/services. In the procurement process, Article 5 explains the principles of procurement of Goods/Services consisting of efficient, effective, transparent, open, competitive, fair/non-discriminatory, and accountable. Presidential regulation has experienced four changes, there are still shortcomings and has not accommodated the development of the Government's needs regarding the regulation of good procurement of Goods/Services.

Presidential Regulation Number 16 of 2018 concerning the procurement of goods services of the Government, in Article 5 concerning the Procurement Policy for Goods/Services includes implementing Procurement of Goods/Services that are more transparent, open and competitive. Furthermore, in Article 6 the procurement of Goods/Services applies the following principles: efficient; effective; transparent; open; compete; fair; and accountable.

IV. PATTERN OF TRANSPARENCY AND ACCOUNTABILITY – DISCUSSION

After the text edit has been completed, the paper is ready for the template. Duplicate the template file by using the Save As command, and use the naming convention prescribed by your conference for the name of your paper. In this newly created file, highlight all of the contents and import your prepared text file. You are now ready to style your paper; use the scroll down window on the left of the MS Word Formatting toolbar.

Library research obtains secondary data from legislation, journals, and books that discuss transparency and accountability. Secondary data produces patterns of transparency and accountability in the fields of non-construction services and construction services. Starting from 2008 with the KIP-Law, then the Government Regulation implementing the KIP-Law, up to the circular letter from the decision of the minister of PUPR.

In the KIP-Law or the Public Information Disclosure Act and the Presidential Regulation on the implementation of the KIP-Law, the definition of transparency is written clearly in the explanation of the legislation. Transparency is openness in carrying out the decision making process and openness in expressing material and relevant information about the company. Presidential Regulation Number 54 of 2010 concerning Government procurement of goods/services, in accordance with Article 93, defines transparency as all provisions and information on Procurement of Goods / Services are clear and can be widely known by Goods/Services Providers who are interested as well as by the public in general. So that the definition of transparency in the implementation of construction, especially the procurement of goods/services of the Government is openness in the process as well as expressing information clearly from the Public Agency and can be known by all parties involved including the community. In Fig. 1 can be seen the legislation that discusses the transparency of the field of non-construction services and construction services.

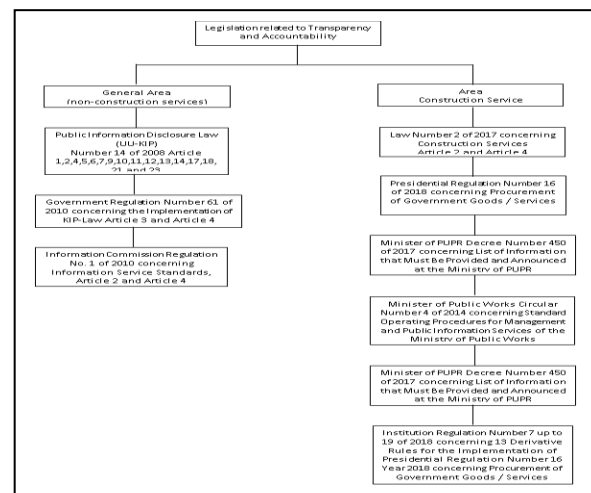

Fig. 1. Pattern of Transparency and Accountability in Legislation in Indonesia

KIP-Law defines information as information, statements, ideas, and signs that contain values, meanings, and messages, be they data, facts, or explanations that can be seen, heard and read, which are presented in various packages and formats according to the development of information and communication technology, both electronically and non-electronically. If described in a positioning, then public information is a subset of only information in a broad sense. Based on the KIP-Law, not all public information is open and may be known or accessed by the public. There is public information called excluded public information, namely information which for various reasons is kept secret or cannot be accessed by the public.

This excluded public information is strict and limited, Public Agencies may not arbitrarily say that information is excluded

information. To exclude public information, the Public Agency must test the consequences of the hazards that arise if the information is opened (consequential harm test). This consequential test is the application of the principle of exclusion from strict and limited public information (maximum access limited exemption). In the KIP-Law, the information that is excluded is regulated in Article 6 and Article 17. In simple terms, the classification of public information can be grouped as in Fig. 2.

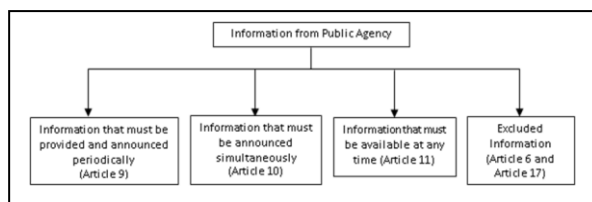

Fig. 2. Classification of Public Information

The picture is a schematic description that groups public information into two types, namely public information that is open and excluded. Open public information can be divided into three groups, namely information that must be provided and announced periodically (Article 9 KIP-Law), must be announced immediately (Article 10 KIP-Law), and information that must be available at any time (Article 11-Law KIP). Whereas public information excluded in Article 17 of the KIP Law is grouped into five, namely:

1. State secret group (Article 6 paragraph (3) letter a and Article 17 letter a, c, d, e, f KIP-Law).
2. Personal secret group (Article 6 paragraph (3) letter c and Article 17 letter g, h KIP-Law).
3. Business secret group (Article 6 paragraph (3) letter b and Article 17 letter b of KIP-Law).
4. Secret position group (Article 6 paragraph (3) letter d), and
5. Information groups that have not been controlled by the Public Agency (Article 6 paragraph (3) letter e).

Library research that has been done, has not found parameters or indicators for each classification of public information, especially in the field of Construction Services. The findings are temporary in reference to the results of library research in the form of legislation related to the procurement of Government goods/services. The latest regulation on the procurement of Goods/Services is the Presidential Regulation Number 16 of 2018 which previously existed in Presidential Regulation Number 54 of 2010.

One of the fundamental changes between Presidential Regulation Number 54 of 2010 and the Amendment to Presidential Regulation Number 16 of 2018 is the change in the definition of procurement of Goods/Services themselves. Presidential Regulation Number 54 of 2010 and its amendments state that Government Procurement of Goods/Services, hereinafter referred to as Goods/Services Procurement, is an activity to obtain Goods/Services by Ministries/Agencies/Regional Work Units/Institutions whose process starts from planning needs to complete all activities to obtain goods / services. Whereas in Presidential Regulation Number 16 of 2018, the definition of Procurement is changed

to Government Goods/Services Procurement, hereinafter referred to as Procurement of Goods/Services, is the procurement of goods/services by Regional Ministries/Institutions/Devices financed by APBN/APBD identification of needs, up to the handover of work results.

With the enactment of Presidential Regulation Number 16 of 2018, all provisions in the Presidential Regulation have already been applied. For the transition period for the enactment of Presidential Regulation Number 16 of 2018, K/L/PD can still carry out the Procurement of Goods/Services by using Presidential Regulation Number 54 of 2010 along with its amendments up to 30 June 2018. Whereas contracts carried out based on Presidential Regulation Number 54 Year 2010 and its amendments continue to refer to Presidential Regulation Number 54 of 2010 along with the changes until the contract expires. After July 1, 2018 K/L/PD must carry out procurement in accordance with Presidential Regulation Number 16 of 2018. Comparison of Presidential Regulation Number 16 of 2018 and Presidential Regulation Number 54 of 2010 can be seen in Table I Matrix of differences from the two Presidential Regulations on Procurement of Goods/Service.

TABLE I. MATRIX OF DIFFERENCES ON TRANSPARENCY BETWEEN PRESIDENTIAL REGULATION 54/2010 AND PRESIDENTIAL REGULATION 16/2018

No	Presidential Regulation 54/2010	Presidential Regulation 16/2018
DEFINITION		
1	Chapter I. General Provisions (Article 1)	Chapter I. General Provisions (Article 1)
	Procurement of Government Goods / Services, hereinafter referred to as Procurement of Goods / Services, is an activity to obtain goods / services by ministries / institutions / regional / institutional work units whose process starts from planning needs to complete all activities to obtain goods / services.	Procurement of Government Goods / Services, hereinafter referred to as Procurement of Goods / Services, is the activity of procurement of goods / services by Regional Ministries / Institutions / Devices financed by APBN / APBD whose process starts from identifying needs, up to handover of work results.
TRANSPARENCY		
2	CHAPTER II. Principles - Procurement Principles (Article 5)	CHAPTER II. Objectives, Policies, Principles, and Ethics for Procurement of Goods / Services (Article 5)
	Procurement of goods / services applies the following principles: a. efficient; b. effective; c. transparent; d. open; e. compete; f. fair / non-discriminatory; and g. accountable.	Procurement of Goods / Services Policies include: implementing more Goods / Services Procurement transparent, open and competitive

3			CHAPTE R II. Objective s, Policies, Principles and Ethics for Procurement of Goods / Services (Article 6)	Procurement of goods / services applies the following principles: a. efficient; b. effective; c. transparent; d. open; e. compete; f. fair; and g. accountable.
ELECTRONIC PROCUREMENT				
4	CHAPTE R XIII. Electronic Procurement (Article 106)	Procurement of goods / services electronically is carried out by means of e-tendering or e-purchasing. E-Purchasing is the procedure for purchasing goods / services through an electronic catalog system. E-Tendering is the procedure for selecting Goods / Services Providers conducted openly and can be followed by Goods / services registered with the procurement system by submitting 1 (one) time the offer has been determined.	CHAPTE R X. Procurement of Goods / Services Electronically (Article 69)	Implementation of Procurement of Goods / Services is carried out electronically using an information system consisting of an Electronic Procurement System (SPSE) and a support system. (2) LKPP develops SPSE and support systems.
4	CHAPTE R XIII. Electronic Procurement (Article 107)	Procurement of Government Goods / Services electronically aims to: a. increase transparency and accountability; b. increasing market access and fair business competition; c. improve the efficiency of the Procurement process; d. support the monitoring and audit process; and e. fulfill real time information access needs.	CHAPTE R X. Procurement of Goods / Services Electronically (Article 70)	Procurement of Goods / Services electronically by utilizing E-marketplace. (2) Goods / Services Procurement E-marketplace provides technical infrastructure and transaction support services for Ministries / Institutions / Regional Governments and Providers in the form of: a. Electronic Catalog; b. Online Store; and c. Selection of Providers. (3) LKPP has the authority to develop, foster, manage and supervise the implementation of the Goods / Services

				Procurement E-marketplace.
5	CHAPTE R XIII. Electronic Procurement (Article 108)	LKPP develops Government Goods / Services Procurement System electronically	CHAPTE R X. Procurement of Goods / Services Electronically (Article 71)	(1) SPSE scope consists of: a. Procurement Planning; b. Procurement Preparation; c. Selection of Providers; d. Contract Implementation; e. Handover; f. Management of Providers; and g. Electronic Catalog.
6	CHAPTE R XIII. Electronic Procurement (Article 109)	The scope of e-tendering includes the process of announcing the procurement of goods / services up to the announcement of the winner.		

CONCLUSION

1. The pattern of transparency and accountability based on library research is illustrated in Figure 1.
2. Based on the results of the discussion also found the classification of public information in Figure 2. Consists of: a. information that must be provided and announced periodically; b. information that must be available at any time; c. other open information requested by the Public Information Applicant
3. Transparency and Accountability in the field of Construction Services based on library research is specifically discussed in the Presidential Regulation on Government Procurement of Goods / Services.

REFERENCES

Anonymous, Law Number 14 Year 2008 concerning Public Information Openness.
 Anonymous, Government Regulation Number 61 of 2010 concerning Implementation of Public Information Disclosure Law.
 Anonymous, Information Commission Regulation No. 1 of 2010 concerning Standards for Public Information Services.
 Anonim, Minister of Public Works Circular Letter Number 4 of 2014 concerning Standard Operating Procedures for Management and Public Information Services at the Ministry of Public Works.

- Anonymously, Minister of PUPR Decree No. 450 of 2017 concerning List of Information that must be provided and announced at the Ministry of PUPR.
- Anonymous, Law Number 2 of 2017 concerning Construction Services.
- Anonymous, Presidential Regulation Number 16 of 2018 concerning Procurement of Government Goods and Services.
- Dani Prabowo. (2018, Agust 16). *Di Sidang Paripurna, Presiden Berberkan Prestasi Infrastruktur*, Retrieved July 4, 2019, from <https://properti.kompas.com/read/2018/08/16/163000921/di-sidang-paripurna-presiden-beberkan-prestasi-infrastruktur->
- Dipopramono A., *Openness and Public Information Disputes*, Renebook, Jakarta, February 2017.
- Erwin Hutapea. (2019, Feb 6) *Anggaran Infrastruktur 2019 Tembus Rp 415 Triliun*, Retrieved July 4, 2019, from <https://properti.kompas.com/read/2019/02/06/230829821/anggaran-infrastruktur-2019-tembus-rp-415-triliun?page=all>
- M. Fajar Marta. (2016, Mei 10). *Akuntabilitas dan Transparansi Proyek Konstruksi Jangan Diabaikan*, Retrieved June 11, 2019, from <https://money.kompas.com/read/2016/05/10/131121326/Akuntabilitas.dan.Transparansi.Proyek.Infrastruktur.Jangan.Diabaikan?page=all>
- Nunuk F. (2012). Keterbukaan Informasi Publik Dalam Pemerintahan Terbuka Menuju Tata Pemerintahan yang Baik. *Journal Rechtsvinding Media Pembinaan Hukum Nasional*, 1(1), April 2012, 151-153.
- Soerjono Soekanto dan Sri Mamudji. (2018). *Penelitian Hukum Normatif suatu Tinjauan Singkat* (1st ed. 18 print). Jakarta Rajawali Press.

Technical and Non-Technical Indicators for Service Index Modeling of Polder System with Retention Pond

1st Dina Noviadriana

Water Resources Engineering
Department
Faculty of Engineering, University of
Brawijaya
Malang, Indonesia
dinanov1978@gmail.com

2nd Ussy Andawayanti

Water Resources Engineering
Department
Faculty of Engineering, University of
Brawijaya
Malang, Indonesia
pengairan@ub.ac.id

3rd Dian Sisinggih

Water Resources Engineering
Department
Faculty of Engineering, University of
Brawijaya
Malang, Indonesia
pengairan@ub.ac.id

Abstract—In the flood management, one way to reduce the volume of flood is by using polder system. This system is implemented by The Government of DKI Jakarta Province with retention ponds in some area. To keep its function, some routine maintenance with appropriate budget of each polder are running, but there are some conditions which give impact to the polder functions and services. There are many aspects that contributed in the decreasing of polder service capability. In other hand, Water Resources Agency of DKI Jakarta Province, who is responsible for the maintenance of those polders, does not have any guideline to evaluate the polder service and correlate it with appropriate maintenance budget. This research analyzed seven selected polders in DKI Jakarta with 41 various variables and indicators that used to evaluate polder services, which are 4 technical variables (Tx) with 17 indicators (tx) and 5 non-technical variables (NTx) with 15 indicators (ntx). As the result of this research, evaluating the polder services are more precisely by using 36 various variables and indicators, which are 4 technical variables with 15 indicators and 5 non-technical variables with 12 indicators. These variables and indicators then could be used to evaluate the polder's service.

Keywords—flood management, polders, indicators

I. INTRODUCTION

DKI Jakarta as capital of Indonesia has complex disaster problems. Based on the risk analysis in 2017 by Regional Disaster Mitigation Agency of DKI Jakarta Province, flood is one of the threatening disaster that regularly happens (BPBD, 2017). In order to minimize the flood damage, common practice was done by making a room for the river, such as canals or bypasses, and making polders (Schultz, 2008). The Government of DKI Jakarta Province has built polders as effort to preventing floods damage besides some regular maintenance such as canals normalization (dredging), flood and rob embankment, retention pond, and drainage system revitalization (Public works Agency of DKI Jakarta, 2012). Based on the book with title "Water Resources Agency" in Numbers Year 2015, the Government of DKI Jakarta Province has been developed 36 polder systems and also planned to developed 11 polders system. Polder system is built with components such as drainage system, retention pond, pumps, water gates and dikes around the area of polder, and should be maintained to keep its function optimal. In Jakarta, the polders are maintained by the Water Resources Agency. Annually, the Agency allocate some budget to keep the Polders' function

in optimum service. But in some cases the polder service could not reach the designed service target (Water Resources Agency of DKI Jakarta, 2018). In 2018, based on the data from Water Resources Agency of DKI Jakarta, there are 70 inundation areas happened inside the polder system with 10 - 50 cm in height and 30 minutes to 1 hour for duration of flood. Therefore, the management of those polders need to be increased with the appropriate budget for each polder.

II. RESEARCH BACKGROUND AND LOCATION

Currently, in some cases the polder service could not reach the designed service target (Water Resources Agency of DKI Jakarta, 2018). During 2018, based on the data from Water Resources Agency of DKI Jakarta, there were 70 inundations areas happened inside the polder system with 10 - 50 cm in height and 30 minutes to 1 hour for duration of flood. These may occur due to ineffectiveness of the maintenance of the polders which are not based on the service of each polder. There are no available guidelines to determine the service level of the polders, result in not proper budget allocation for revitalizing polders and not planned based on priority scale. In order to standardize the criteria of polder's condition, the Model of Polder System Service Index which collaborate technical aspects and non-technical aspects for prioritize polder maintenance are urgently needed. Either technical or non-technical aspects are integrated to support water resources management in future (Nillesen, 2015). Technical aspects could be used to see the function of polders, meanwhile non-technical aspects, such as organizational, budgeting, economic aspect, social and legal aspects could be used to see the polders service (Rianto, 2012) also the participation of stakeholders and the community lives in the polders (Jatmiko, 2014).

Based on the literature study, there is no previous research that went over Polder System Service Index Model and integrated all indicators from technical aspects and non-technical aspects. Therefore, the problem that occurred is how to formulate variables and indicators, both technical or non-technical, which are used to assess and analyze polder services. This research will include new indicators, they are frequency of flood occurrence and increase of assets.

The main purpose of this research is to indicate which factors are affecting the capability of polder function and services. The benefits of this research are to simplify and as a reference that can be used by The Water Resources Agency in Indonesia to assessing the polder service. By knowing the polder service capability, Water Resources Agency can make a better decision and take action to maintain and optimize its function as it should be.

As a location of study, DKI Jakarta Province was chosen because as a capital of Indonesia, this city has a lot of problems due to water management, including access to clean water and flood mitigation during rainy weather. The Government of DKI Jakarta Province has built polders as effort to preventing floods damage. Totally, there were 36 polders built in and developed. Management of those polders are divided in 3 regions, they are western region, central region and eastern region. For this research, seven polders used as an object, which has a pond inside the polder systems. Those polders are Polder Grogol, Polder Teluk Gong and Polder Tomang in West region, Polder Setia Budi Barat and Polder Melati in Central Region, Polder Pulomas and Polder Sunter Selatan in East Region. Fig.1 shows Locations of Polders in DKI Jakarta Province, covers the location of 36 existing polders and 11 planned polders.

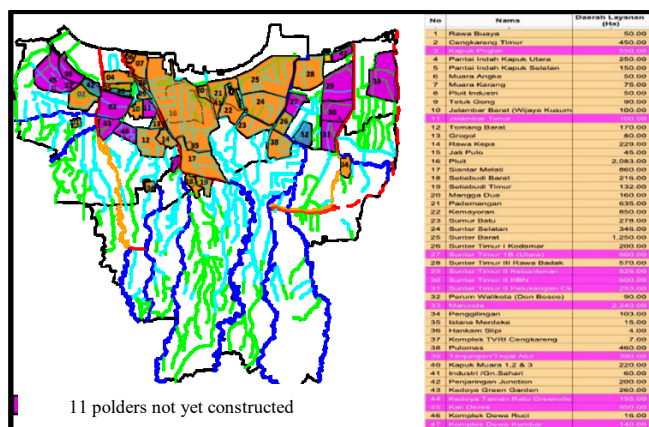

Fig. 1. Locations of Polders in DKI Jakarta Province (Water Resources Agency of DKI Jakarta, 2018)

III. LITERATURE REVIEW

The concept of flood control in DKI Jakarta was made in 1973, in DKI Jakarta Drainage Master Plan. Before 2012, Flood control was defined based on distances of people from the flood by constructing the diversion channel, levee, river improvement and many other flood control constructions. Then, in the Book of Flood Control System of DKI Jakarta Province (2012), flood control technology has been increasing more effective and efficient. In that book, the principle of flood control was changed to flood mitigation and how to decrease the flood loses. Basic concept of flood control in DKI Jakarta are: 1) In DKI Jakarta, water flows from upstream to the sea through floodway on the outer side of Jakarta; 2) In the area with enough slope and height water flow by the gravity; 3) In the lower area, in Centre and North Jakarta, polder system is used and water is pumped to the sea; 4) Retention ponds in

upstream area must be maintained in order to storage rainfall and reduce the water flow to the downstream.

In fact, to minimize flood impact in Jakarta, structural and non-structural efforts are needed. Some example for structural efforts are by making water storage and reforestation in upstream area, by dredging, making floodway and polders in downstream area. As non-structural effort, the example is by improving mitigation system, such as early warning system, community awareness, making hazardous map and role sharing.

Volker (1983) defined polder as reclamation area with high water level that isolated from hydrological regime around it, it makes water level can be controlled. Meanwhile, Segeren (1983) defines polder as a land with permanent or periodical water level, which makes it separated from hydrological regime around it so water level can be controlled. Common definition used was stated by the International Commission on Irrigation and Drainage (ICID) in 1996, which defined polder as the flood control technology completed by physical equipment, such as drainage system, retention pond, water gate and pump that should be maintained as inseparable and integrated water resources management. Al Falah (2000) defines polder as a handling of drainage system which makes its catchment area isolated from water overflow outside the area and control the flood water level in the system based on a plan. From those definition, Zulfan (2013) concludes that the objects of polder system are the area with following characteristic: 1) isolated as one hydrological system; 2) water level and groundwater can be controlled; and 3) inundated area in natural condition. Potential polder areas were located in swamp area. These low areas mostly formed as a basin where the drainage water should be collected to a storage pond and then pumped into the river.

Meanwhile, Water Resources Agency (2018) defines polder as a drainage area, which is bordered by dike or surface higher than the area and some of them have storage pond and pump as the specific characteristic. The storage is used to collect water from drainage system before it released to floodway, river, or sea using pumps. By polder system, flooding area bordered clearly, so water level, debit, and water volumes that will release can be controlled.

Previous studies resulted assessment analysis which including the form of urban drainage service level indicators, irrigation and drainage network performance assessment and flood index. Those studies were used as a reference in the analysis of polder system service. Variable of drainage system service level are latent variable which is unobserved variable. This Variable consist of 6 of first level dimensions which contribute to the drainage system service (Andayani & Yuwono, 2012). Those dimensions are 1) Water management in drainage system; 2) Software; 3) Government Participatory; 4) Infrastructure; 5) Operation and maintenance; 6) Natural disaster. Research variables were constructs or characters, which have varied values that will be studied (Kerlinger, 2000). Meanwhile, Sugiyono (2006) explains that the research variables are all kind of form determined by the researcher to be studied, so that information about it is obtained and concluded. According

to Kerlinger (2000), the variable itself is divided into 2 (two), namely:

1. Independent Variable

Independent variable is a variable that is affected by change or it creates a dependent variable. In experiments, independent variables are variables that can be manipulated or varied by experimenters using various methods.

2. Dependent Variable

The dependent variable is a variable that is influenced or created from an independent variable. The dependent variable cannot be manipulated, but the variation is observed as a result of predictions derived from the independent variable.

Indicator of research is defined as an indirect dimension of an event or condition (Wilson & Sapanuchart, 1993). Meanwhile according to the United States Department of Health, Education and Welfare (2004) indicator defines as statistics that used to help researchers to make comprehensive, balanced and brief assessments for a various conditions.

IV. METHODOLOGY

In this research, to determine useful indicators to analyze polder service index, polder with storage pond or retention pond will be used. Based on data from Water Resources Agency of DKI Jakarta, there are 36 built-up polders where 15 polders have a storage pond or retention pond. Tables below respectively shows list of 15 polders in each water resources management system region in DKI Jakarta in West Region, Central Region, and East Region.

TABLE I. LIST OF POLDER IN WATER RESOURCES MANAGEMENT SYSTEM OF WEST REGION

No.	Name of Polder	Area of Polder (ha)	Main River	Name of Storage	Area of Storage (ha)
1.	Grogol	99,24	K.Grogol Kanal Banjir Barat	Grogol Storage	1,72
2.	Jelambar	555,17	K. Angke K. Sekretaris K. Grogol	Wijaya Kusuma Storage	0,91
3.	Kamal – Kalideres	2314,92	K. Semongol K. Mookevart K. Kamal Benda K. Apuran Atas K. Maja	Kalideres Tegal Alur Storage	1,81
4.	Teluk Gong	151,00	K. Angke Kanal Banjir Barat	Teluk Gong Storage	2,62
5.	Tomang – Tanjung Duren	706,54	K. Grogol K. Sekretaris Sodetan Sekretaris	Tomang Storage	6,08

Source: Water Resources Agency of DKI Jakarta, 2018

TABLE II. LIST OF POLDER IN WATER RESOURCES MANAGEMENT SYSTEM OF CENTRAL REGION

No.	Name of Polder	Area of Polder (ha)	Main River	Name of Storage	Area of Storage (ha)
1	Melati	398,8	K. Cideng Kanal Banjir Barat K. Gresik K. Surabaya	Melati Storage	3,25

No.	Name of Polder	Area of Polder (ha)	Main River	Name of Storage	Area of Storage (ha)
2.	West Setia Budi	216,00	K. Ciliwung BKB	West Setia Budi Storage	4,00
3.	Setia Budi Timur	132,00	K. Ciliwung BKB	East Setia Budi Storage	3,00
4.	Pluit	2889,19	K. Tamansari K. Besar K. Jelakeng K. Beton K. Duri Ladeng K. Tubagus Angke K. Muara Karang K. Ancol Bandang	Pluit Storage	73,87

Source: Water Resources Agency of DKI Jakarta, 2018

TABLE III. LIST OF POLDER IN WATER RESOURCES MANAGEMENT SYSTEM OF EAST REGION

No.	Name of Polder	Area of Polder (ha)	Main River	Name of Storage	Area of Storage (ha)
1.	Kodamar	196,22	K. Sunter	East Sunter I Storage	5,33
2.	Rawa Badak	724,72	K. Sunter K. Betik	East Sunter III Storage	7,17
3.	Ancol	647,38	K. Ancol K. Sentiong K. Mati Pademangan K. Pademangan Timur K. Pademangan Barat	Kemayoran Storage	12,47
4.	Pulomas	434,00	K. Sunter K. IKIP K. Kampung Ambon	Pulomas Storage and Pacuan Kuda Storage	12,00
5.	North Sunter	1159,04	K. Lagoa Item	North Sunter Storage	30,31
6.	South Sunter	736,67	K. Sentiong K. Sunter	East Sunter Storage	31,55

Source: Water Resources Agency DKI Jakarta, 2018

For this research purpose, those 15 polders have been identified and classified by their complete component inside the polder area to make complete analysis of polder service, which have a storage pond, a water gate, pumps and trash racks. There are 10 polders have complete components and to simplify this research, those polders were classified by its area and shown at table below.

TABLE IV. CLASSIFICATION POLDER BASED ON ITS AREA IN DKI JAKARTA

Region	< 100 Ha	100 – 300 Ha	300–700 Ha	>700 Ha
West Region	Grogol (99,24 Ha)	Teluk Gong (151 Ha)		Tomang – Tanjung Duren (706,54 Ha)
Central Region		East Setia Budi (132 Ha) West Setia Budi (216 Ha)	Melati (398,8 Ha)	
East Region		Kodamar (196 Ha)	Pulomas (434 Ha)	Rawa Badak (724,22 Ha) South Sunter (736,67 Ha)

From the table above, in each classification of polder area, 7 polders were chosen as study locations. Those are Polder Grogol which have an area < 100 ha, Polder Teluk Gong and Polder West Setia Budi which have area between 100 – 300 ha, Polder Pulomas and Polder Melati which have area

between 300 – 700 ha, also Polder Tomang – Tanjung Duren and Polder North Sunter which have area more than 700 Ha.

TABLE V. RECAPITULATION CONDITION OF 7 CHOSEN POLDER

Indicators	Polder Melati	Polder Grogol	Polder Teluk Gong	Polder Pulomas	Polder Setiabudi Barat	Polder Tomang	Polder North Sunter
Catchment area (Ha)	398,8	99,24	151	434	216	706,54	1159,04
Retention Pond Area (Ha)	3,25	1,718	2,62	12	4	6,08	30,31
Number of pump (unit)	16	3	3	5	7	20	5
Pump(s) capacity (m ³ /s)	18,8	2,7	3	8,5	8,9	23,2	20,4
Number of trash rack (unit)	5	2	3	3	2	4	5
Number of sluice gate (unit)	2	2	2	1	2	4	5

Methodology that used in this research is by detailing those 1st level dimensions to 2nd level dimension become 41 observed indicators. The research analysis was done scientifically, using linear regression in technical and non-technical aspect. Those unobserved variable for each aspect was selected and the analyzed.

Research method that is used in this research are as written below:

1. First stage of this research was classifying the polder based on the completion of the components and based on the area of those polders;
2. Second stage was collecting secondary data from the polder system management officer of the polder system, which is the Government of DKI Jakarta Province, especially the Water Resources Agency. After collecting, the data were verified to determine its accuracy;
3. Primary data were collected by interviewing the officer who maintain the polders and local communities who live in the area for a long time period so they are aware about the developments of the area before and since the polder was constructed. Besides interviews, primary data were collected by observing the surrounding conditions;
4. After data collection and the verification that has been carried out on each polder, indicators are formulated which affect the performance of the polder;
5. Chosen indicators are verified its correlation each other using Partial Least Square (PLS) method. In this research PLS analyzed using Smart PLS software;
6. Furthermore, the selected technical and non-technical indicator variables were analyzed to determine the respective index size. After the technical and non-technical indices have been obtained, the two indices are combined and calibrated into a polder system service index.

V. ANALYSIS AND RESULT

By observing those locations, primary data analysis and secondary data in each polders, there are some indicators that cause the decreasing in capability of polder service, they are: 1) Land use, 2) Condition and capacity of structure and equipment in polder, 3) Inundated area in the polder, 4) Operation and Maintenance cost, 5) Value of assets, 6) Institutional, 7) Human Resources, 8) Standard Operation Procedure, 9) Participatory, 10) Law and regulation, 11) Economic Socio-cultural, and 12) Flood losses.

Those conditions were analyzed in each polder based on the observation, interviews with community and officer of Water Resources Agency of DKI Jakarta Province, and by analyzing secondary data, as follows:

1. Technical aspects

This aspects including countable and measureable number from secondary data (rainfall and climatology), and primary data that can measured in sites.

- a. Variable : Flow pattern (T1)

Indicator : Time of concentration in minute (t_{1a}) and land cover in Percentage (t_{1b})

The covered area in the polder catchment area changed over the time. Increased built-up area causing changes in time concentration become faster than before. Faster concentration time causes lower service of polder, because polder and retention pond capacity has designed for certain condition of catchment area and projected into several years later for normally conversion of land-use. It shown that time concentration and land cover could be used for indicating polder service.

- b. Variable : Condition and capacity of structure and equipment in polder (T₂)

Indicator : Capacity of polders in m³ (t_{2a})

In order to optimizing the function of polder services, polder capacity is the most necessary thing. If the pond has no optimal capacity, the pond will not be able to accommodate the volume of water from the catchment area of the polder. This condition will cause inundation in polder area that lower polder service.

Indicator : Condition of sluice gate in percentage (t_{2b})

Condition of the sluice gate will affect the speed of water released to the sea or river in the polder reservoir, when the water in the river lower than water in the pond. In good condition, sluice gate can be easily to operate, so while water in sea or river higher than water level in the pond, back water that caused inundated in polder area can be prevented.

Indicator : Condition of pump in m³/sec (t_{2c})

Condition of the pump greatly affect the performance and the speed of the pump to move water in the pond/ polder reservoir to the river or the sea, when the water in the river is high. If condition of the pump is not in a good condition, it will reduce the speed of pump capacity to move the water, and causes inundation in polder area during heavy rain.

Indicator : Age of pump in year (t_{2d})

Age of the pump, that exceeded the lifecycle of the pump, will affect its performance. The age of the pump exceeded its lifecycle time, it will reduce the ability of the pump, especially when the maintenance budget is not optimal. Longer age of pump with low maintenance can causes delaying time of pumping, then it causes inundation and decreasing polder service.

Indicator : Condition of Trash-rack in percentage (t_{2e})

Condition of trash-rack affects optimization of the performance of trash rack to filter waste in the polder pond/ reservoir. Piles of garbage in the pond/ polder reservoir will reduce the capacity of the polder reservoir.

Indicator : Condition of Generator set in percentage (t_{2f})

Condition of the generator set will affect the performance of the pump when the electricity goes out. Often this condition arises where due to heavy rain, electricity turns off and or is turned off, so the operation of the pump is very dependent on the generator.

Indicator : Rate of land use change in percentage per year (t_{2g})

The rate of land use change that is increasing every year will affect the speed of water seeping into the soil. This condition results in greater surface flow and ultimately causes inundation.

c. Variable : Inundation (T₃)

Indicator : Inundation area in percentage (t_{3a}), inundation height in meter (t_{3b}), inundation duration in hour (t_{3c}), frequency of inundation occurs in times per year (t_{3d})

The occurrence of inundation is a visual representation of the service of a polder. The wider and higher the inundation and the longer the inundation recedes indicates the decreasing of polder service. Similarly, more frequent inundates occur indicate that there are components in the polder that are not working optimally.

d. Variable : Technical economics (T₄)

Indicator : Operating cost in rupiahs (t_{4a}), Maintenance cost in rupiahs (t_{4b})

This indicator will be needed to evaluate, because the allocation of operating and maintenance costs, which are less than the allocation needed, will affect the decline in the performance of the components contained in a polder.

Indicator : Age of the polders in year (t_{4c})

In relation to the economic value of a polder, the function of the polder that has been built for a long time tends to decrease, especially if it is not balanced with the needed operational and maintenance costs.

Indicator : increase value of polder assets in rupiahs (t_{4d})

The additional asset values in a polder system, such as adding pumps, adding garbage filters, or adding

sluice gates, occurs because the existing polder system is not optimal in meeting established service targets.

2. Non-technical aspects

a. Variable : Institutional (NT₁)

Indicator : Organization Type and Structure (nt_{1a})
The organization is the important thing in a management. Success or failure of a management depends on the type, structure and management of the organization.

Indicator : Decision making (nt_{1b})

Time spent for making the decision is one of the important thing in polder management. A prolonged decision-making process will cause delays in handling a polder and causes inundation.

Indicator : Human Resources (nt_{1c})

Operators are very necessary to operate the components, such as pumps, sluice gates, thrash racks that constructed in a polder, so that the suitability of the number and ability of the operators with the needs is closely related to the assessment of the services of a polder.

Indicator : Supervisory Agency (nt_{1d})

The presence of a supervisory body can help polder managers to monitor and evaluate the performance of the manager in managing the polder every year, then will guide the polder manager to maintain the polder for optimal result.

Indicator : Standard Operation Procedure (SOP) (nt_{1e})

Standard Operation Procedure (SOP) provides guidance for polder managers in carrying out the operation and maintenance of the polder.

Indicator : Master Plan (nt_{1f})

Using polder master plan, polder managers can review the capabilities of a polder, especially related to changes in extreme weather, such as higher rainfall, and changes in land use in the polder.

b. Variable : Role Management (NT₂)

Indicator : Community Forums (nt_{2a}), Public and private participation (nt_{2b})

Participation of the community and / or the private sector in the operation and maintenance efforts can also help maintain and improve the service of the polder system.

c. Variable : Law and Regulation (NT₃)

Indicator : Monitoring of laws and regulations (nt_{3a})

By monitoring of laws and regulations, everything related to the polder management efforts can be carried out properly, so the polder service is maintained.

Indicator : Law enforcement (nt_{3b})

Law enforcement efforts will minimize the occurrence of offenses committed by the community that can disrupt the sustainability and function of the polder, so that the polder service is maintained.

Indicator : Reward to community (nt_{3c})

Reward for the community will increase the spirit of the community to participate in the management of

the polder, and even form a forum with a definite organization and help the local government to manage the polder.

d. Variable : Socio-cultural and economic (NT₄)

Indicator : Education level (nt_{4a})

The higher level of education from the community around the polder, the community awareness will be higher in managing the polder.

Indicator : Income level (nt_{4b})

The level of community incomes is hugely contribute to polder function. The higher level of income of the community lives in polder area, the community awareness to contribute to manage the polder will be even higher.

Indicator : Economic activity near polder (nt_{4c})

More economic activities carried out in the polder area, the more problems will arise, such as garbage problems, illegal houses and environmental pollution which will affect the sustainability of polder function.

e. Variable : Flood Losses (NT₅)

Indicator : Flood losses (nt_{5a})

Flood or inundation can cause losses, depending on the location of the inundation. A good polder system service will minimize losses due to inundation in an area, which in turn will provide feedback on the performance of the polder system itself.

Using the scoring number, those 41 indicators are adjusted and analyzed using Smart PLS software to check its correlation each other. Fig. 3 below shows output from smart PLS software analysis. Bold line represents high correlation between latent variables and indicators connected.

Based on PLS analysis, from 41 indicators from observation and literature study analysis above, there are 5 indicators that have very low correlation to each other and to service index polder. They are time of concentration (t1a), polder's age (t4c), organization structure (nt1a), masterplan (nt1f), and education level (nt4a). For further purpose, analysis of those 5 indicators are not needed.

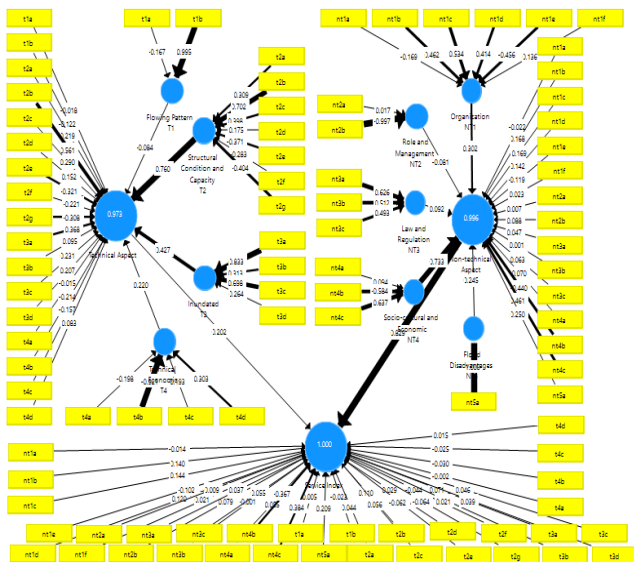

Fig. 2. Output Result of Smart PLS

VI. CONCLUSION AND RECOMMENDATION

To sum up, there are 36 indicators that can be used for analyzing polder system service level. Those indicators are separated into 2 aspects, technical and non-technical aspect, as shown in Table VII and Table VIII respectively.

TABLE VII. TECHNICAL ASPECTS VARIABLE AND INDICATOR FOR ASSESSMENT OF POLDER'S SERVICE

No	Variable	Indicator
1	Flowing Pattern (T ₁)	Land cover (%) (t _{1b})
2	Structural Condition and Capacity (T ₂)	Storage capacity (m ³) (t _{2a})
		Sluice gate condition (% of broken) (t _{2b})
		Pump condition (m ³ /s) (t _{2c})
		Pump's age (years) (t _{2d})
		Trash-rack condition (% of broken) (t _{2e})
		Generator set condition (% of broken) (t _{2f})
3	Inundated (T ₃)	Speed of land-use changing (% per year) (t _{2g})
		Inundated area (%) (t _{3a})
		Height of inundated (m) (t _{3b})
		Average duration of inundated (hours) (t _{3c})
4	Technical Economic (T ₄)	Frequent of inundated (times) (t _{3d})
		Operation cost (rupiah) (t _{4a})
		Maintenance cost (rupiah) (t _{4b})
		Increasing number of polder's assets (t _{4d})

TABLE VIII. NON-TECHNICAL ASPECTS VARIABLE AND INDICATOR FOR ASSESSMENT OF POLDER'S SERVICE

No	Variable	Indicator
1	Organization (NT ₁)	Decision making (nt _{1b})
		Human resources / operator (nt _{1c})
		Supervisory Agency (nt _{1d})
2	Role and Management (NT ₂)	Standard Operation Procedure (SOP) (nt _{1e})
		Community Forums (nt _{2a})
3	Law and Regulation (NT ₃)	Public and private participation (nt _{2b})
		Monitoring of laws and regulations (nt _{3a})
4	Socio-cultural and economic (NT ₄)	Law enforcement (nt _{3b})
		Appreciation (nt _{3c})
5	Flood disadvantages (NT ₅)	Income level (nt _{4b})
		Economic activity near polder (nt _{4c})
		Inundate disadvantages (nt _{5a})

For further purposes, further research is needed to create a polder system service index model.

VII. REFERENCES

Alfalah, 2000, Diktat Kuliah Drainase Perkotaan, UNDIP, Semarang.

Andayani, S., & Yuwono, B. E. (2012). Variabel Tingkat Layanan Drainase Perkotaan. *Teknik Sipil*, 11(2), 148-157.

Bouwer, Laurens M., Bubeck, Philip, Wagtenonk, A.J. and Aerts, J.C.J.H. (2009). Inundation Scenarios for Flood Damage Evaluation in polder areas. *Natural Hazard and Earth System*, 9:1995-2007

Bouwer, Laurens M., Bubeck, Philip and Aerts, J.C.J.H. (2010). Changes in Future Flood Risk due to Climate and Development in A Dutch Polder Area. *Global Environmental Change*, 20:463-471

Dieperink, C., Hegger, D.L.T., Bakker, M.H.N., Kundzewich, Z.W., Green, C. (2016). Recurrent Governance Challenges in the Implementation and Alignment of Flood Risk management Strategies: a Review. *Water Resources Management*, 30:4467-4481.

Dinas Sumber Daya Air Provinsi DKI Jakarta. (2018). Pengelolaan Sungai dan Drainase Dalam Rangka Antipapi Banjir.

- Indonesia, Badan Penanggulangan Bencana Daerah (BPBD). (2010). Rencana Penanggulangan Banjir di Provinsi DKI Jakarta.
- Indonesia, Badan Nasional Penanggulangan Bencana (BNPB). (2012). Pedoman Umum Pengkajian Risiko Bencana.
- Indonesia, Kementerian Pekerjaan Umum. (2015). Pengelolaan Banjir Komprehensif di Provinsi DKI Jakarta.
- Indonesia, Badan Penanggulangan Bencana Daerah (BPBD). (2017). Rencana Penanggulangan Bencana 2013-2017 Pemerintah Provinsi DKI Jakarta.
- Jatmiko, Adi., Darmanto dan Sunjono. 2014. A Study Of Capability And Willingness Of Local Society To Fund The Operational And Maintenance Of Polder In Banger River Semarang. *Civil Engineering Forum*.
- Kerlinger, Fred N. (2006). Asas-Asas Penelitian Behavioral.
- Manen, Sipke E. and Brinkhuis, Martine. 2005. Quantitative Flood Risk Assessment for Polders. *Reliability Engineering and System Safety*, 90 : 229 - 237.
- Miranda, A.A., Borgne, Y.A.L. dan Bontempi, G. 2008. [New Routes from Minimal Approximation Error to Principal Components](#). *Neural Processing Letters Springer*, 27:1-10
- Moel, H. 2010. Effect of Uncertainty in Land Use, Damage models and Inundation Depth on Flood Damage Estimates. *Natural Hazard and Earth*, 58:407-425.
- Nillesen, Anne, Kok, Matthijs. (2015). An Integrated Approach to Flood Risk Management and Spatial Quality for a Netherlands' River Polder Area. *Mitigation Adaptation Strategy Global Change*, 20:949-966.
- Rianto, Nanang. 2012. Penyusunan Aspek Organisasional Pengelola Polder, Studi Kasus : Kali Banger, Kota Semarang. *Widyariset*, 15:39-48.
- Schultz, Bart. (2008). Water Management and Flood Protection of the Polders in the Netherlands Under the Impact of Climate Change and Man-Induced Changes in Land Use. *Water and Land Management*, 12:71-94.
- Segeren. (1983). Dalam F.X. Suryadi. (2014). Hydraulic Performance of Urban Polder Water Management and Flood Protection System in Jakarta. *Conference Paper of 13th International Conference in Urban Drainage*
- Sugiyono. 2006. Metode Penelitian Kuantitatif, Kualitatif dan RD. Bandung : Penerbit Alfabeta
- Suprayogi, Hari., Bisri, Mohammad., Limantara, Montarich. dan Andawayanti, Ussy. (2018). Service Index Modelling of Urban Drainage Network. *GEOMATE*, 15:95-100.
- Vadlon. (2011). Desain Kriteria Penilaian Sistem Jaringan Drainase Kota Parigi Kabupaten Parigi Moutong. Universitas Sebelas Maret, Surakarta.
- Volker. (1983). Dalam F.X. Suryadi. (2014). Hydraulic Performance of Urban Polder Water Management and Flood Protection System in Jakarta. *Conference Paper of 13th International Conference in Urban Drainage*.
- Wilson, R, dan T Sapanuchart. Primary Health Care Management Advancement Program. Aga Khan Foundation, 1993.
- Zulfan, James and Hana, Maria Asunta. (2013). Pengelolaan Polder Banger Berbasis Kebersamaan antar Stakeholder. *Teknik Pengairan*, 8:15-22.

The Effectiveness of Addition of Infilled Wall Against Earthquake Load in Building Models

1st Fanny Monika

Department of Civil Engineering, Faculty of Engineering
Universitas Muhammadiyah Yogyakarta
Yogyakarta, Indonesia, 55183
fanny.monika.2007@ft.umy.ac.id

2nd Muhammad Ibnu Syamsi

Ph.D Student in Department of Civil Engineering
National Central University
Jongli City, Taoyuan County, Taiwan
syamsibnu@umy.ac.id

Abstract— *The Yogyakarta region is an area that has quite a high earthquake activity. Meanwhile, the usual earthquake resistant building design ignores the influence of wall stiffness. For this reason, it is necessary to evaluate the structural behavior of earthquake loads, if the infill wall is included in the analysis. This research was conducted at the Postgraduate Building of the Faculty of Medicine, Gadjah Mada University. The purpose of this study is to look for the effect of displacement and interstory drift with additional infill walls. The research was conducted with ETABS software to make the model according to the actual conditions. The earthquake load simulated using equivalent static load and spectrum response. The structure model of the open frame structure building and the infill frame structure are modeled to compare the results. Result analysis shows that interstory drift in the open frame structure model is not safe because it exceeds the permit limit. While the infill frame structure of each floor is still within the range of permit values so that the structure deviation is still in the safe category as required by SNI 1726-2012.*

Keywords— *Infilled Wall, SNI 1726-2012, open frame structure, and drift ratio*

I. INTRODUCTION

Indonesia is located between several tectonic plates of the world, namely the Indo Australia plate which moves towards the north, the Pacific plate that moves towards the northwest and the Eurasian plate, so it often experiences earthquakes. The area of D.I Yogyakarta is an area that has quite high earthquake activity, so it is necessary to evaluate the structural performance of earthquake loads starting with making a model using data according to actual conditions and then calculating according to local conditions.

Performance evaluation can provide information about the extent to which an earthquake will affect the structure of a building. This is important for evaluating the seismic behavior of post-melting building structures (Pranata, 2006).

The important thing about performance-based evaluation is that the building's performance targets against earthquakes are clearly stated. The performance targets consist of earthquake events, and the level of allowable damage or level of performance (performance level) of the building against the earthquake event (Dewobroto, 2006).

Schodek (1999) states that in a stable structure when subjected to a load, the structure will experience a smaller deformation than an unstable structure. This is because the stable structure has the strength and stability in holding the load.

In analyzing earthquakes in buildings there are several variables that must be considered, namely horizontal deflection (drift) and the period of the building structure. Excessive drift will burden the structure and can damage buildings both structural and non-structural. On the other hand, the deformation of the structure means that some energy is dissipated from seismic forces (Ambrose & Vergun, 1999). The building period is the condition when the building is exposed to melting and ejected laterally by earthquake, wind and other loads, the building will be swayed back and forth with regular periods or can be called a natural period (Lindeburg & McMullin, 2008).

In general, building portal planning is done by modeling the column beam structure and earthquake force retaining structures without being modeled as infill walls (brick walls) or often called open frame structure.

The infill wall in fact does overload the structural elements but also has stiffness. Stiffness of the wall when included in the modeling will certainly add to the overall structural rigidity of the system.

The stiffness of the structure is inversely proportional to the displacement value so that the addition of the infill wall in the open frame structure model is expected to be able to reduce the displacement value received. The open frame structure model with the addition of infill walls is often referred to as the infilled frame structure. How much influence the addition of infill walls in resisting deviation due to earthquake forces needs to be investigated further.

The difference in behavior of the open and infilled frame structure models is very important to understand. By understanding the differences in their behavior, we can more easily determine the structure model that is more suitable. Therefore, how much difference in the basic shear force of the building, the stiffness of the structure, the displacement that occurs, and how much the difference in other structural responses of the two models need to be studied more deeply.

Dorji and Tambiratnam (2009) have conducted a study of infilled frame structure. The relationship between the frame and the infill wall is modeled with a gap. Gap rigidity was sought by trial and error and compared with other studies. Seismic load analysis in this study was carried out with time history to find the strength of buildings with infill walls, soft-storey phenomenon, natural period deflex, and stresses that occur. The results of this study indicate that the elastic modulus of the infill wall is very influential on the value of period vibration displacement, and interstory-drift. All of these

responses decrease with increasing modulus of elasticity. The greater the opening in the infill wall, the displacement value will increase. In addition, the natural vibration period is not too affected by the wall thickness of the filler for the overall response.

Tanjung (2016) examined the effect of red brick walls on the lateral resistance of reinforced concrete structures, the results showed that the use of red brick as a filler wall resulted in increased lateral resistance of the structure, lateral resistance of reinforced concrete structures will be plastered on both sides and fillers in the form of red bricks will delay collapse structure in reinforced concrete structures.

This research was conducted at the Postgraduate Building of the Faculty of Medicine, Gadjah Mada University using ETABS software to create building modeling using 3 earthquake input data in the form of acselogram recordings converged using Sesmomatch software.

II. EARTHQUAKE

Earthquakes are usually caused by sudden movements of the earth's crust (sudden slip). A sudden shift occurs because of the source of force as the cause, both from natural sources and from human assistance (artificial earthquakes). Tectonic earthquakes are generally the largest earthquakes compared to other types of earthquakes. This type of earthquake is very closely related to tectonic plate activity both regionally and globally. The movement of tectonic plates / rock masses can collide (convergent), shift (shear), pull together (tension) and a combination of both. Two tectonic plates that collide or shift will cause stress, deformation and strain energy accumulation will occur. If the rock stress that occurs is very large and can no longer be held by rocks, rock damage will occur (Prawirodikromo, 2012).

III. DRIFT RATIO

Drift is the ratio value between the deviation that occurs on the floor which is viewed on the floor height. The value of total drift or elastic transfer between floors on floor x (δ_{ex}) can be generated through the output of the building deviation Elastic displacement is obtained by finding the deviation difference that occurs on the floor that is reviewed with the floor below. The deflection enlargement factor (C_d) and building priority factor (I_e) must be included in determining the value of story drift. SNI 1726: 2012 requires that the value of story drift (δ_x) must be determined through equation (1).

$$\delta_x = \frac{C_d \cdot \delta_{ex}}{I_e} \leq \Delta a \tag{1}$$

The ultimate limit performance of the value of story drift will be obtained in this study. The building will be said to be safe if the value of the story drift analysis results do not exceed the permitted limits (Δa) according to SNI 1726: 2012.

Without proper consideration during the design process excessive deflection and drift can have adverse effects on structural elements, nonstructural elements, and time history methods (Sameer & Gore, 2016).

IV. BUILDING STRUCTURE DATA

The study was conducted at the lecture building and the Postgraduate laboratory of the Faculty of Medicine, Gadjah Mada University, Yogyakarta. The building is a reinforced

concrete structure with a height of 38.75 meters and a roof construction of 6 meters high. The Skybridge consists of 2 levels that stretch across both building structures (Building A and Building B) at an altitude of 9.65 meters.

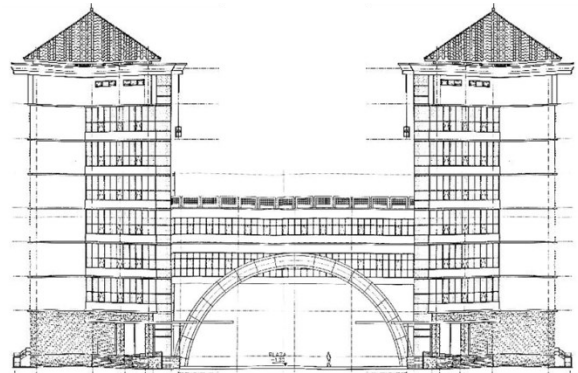

Fig. 1. The front view of the Postgraduate building of the Faculty of Medicine UGM.

The building consists of two buildings and one connecting bridge where the shape of the building has the same plan which differs only from the direction of orientation facing each other. The building has the same structure and division of space on the first floor to the 7th floor. Semi basement is functioned as a parking lot for both building A and building B. Whereas on the 8th floor the room has a different structure plan where many columns are reduced.

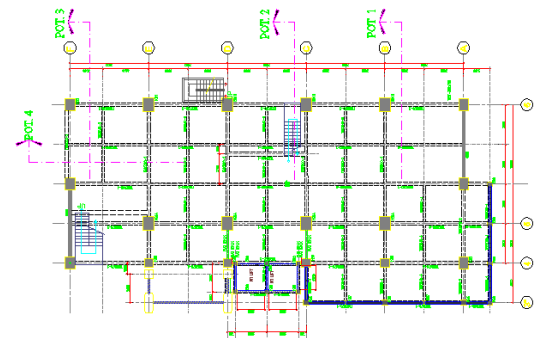

Fig. 2. Semi basement floor

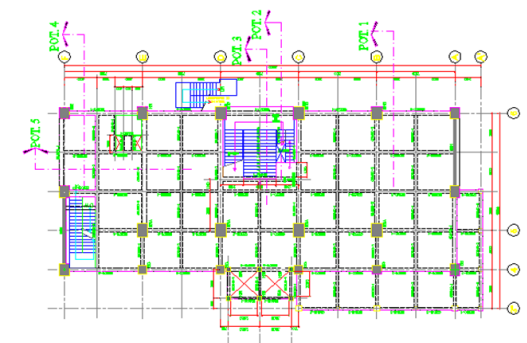

Fig. 3. floors 1-7

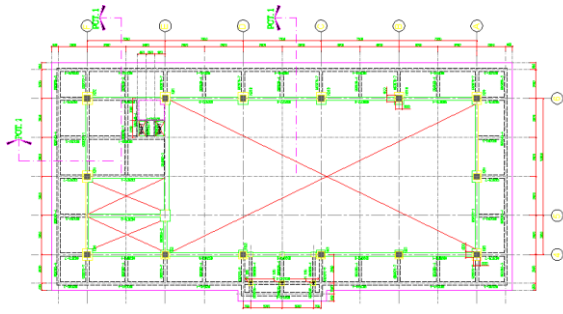

Fig. 4. 8th floor .

TABLE I. DESCRIPTION OF THE BUILDING

Building Description	Explanation
Structural System	Special Reinforced Concrete Sliding Wall
Building Functions	Laboratory and Lecture Buildings
Number of Floors	8 floors
Maximum Building Height	44.75 meters
Number of Semi Basement	1 floor
Skybridge Height on The 3rd Floor	9.65 meters

V. METHODS

A. Analytical method

- Study of literature

Literature study was taken as the basis of the guideline for analysis to be carried out by studying all matters relating to dynamic and static analysis. The reference books used include SNI 03-1726-2002 concerning Earthquake Resilience Planning Standards for Building Structures, SNI 1726: 2012 concerning Planning Procedures for Earthquake Resilience for Buildings and Non Building Buildings and related publication journals that support analysis .

- Data collection

The collection of primary data and information related to the Postgraduate Building of the Faculty of Medicine, Gadjah Mada University, was obtained through the KMK UGM directly. The data obtained in the form of a drawing of the Faculty of Medicine Postgraduate Building plan in the form of soft files and hard files. This data will be used as a basis for structural modeling in 3-dimensional form which is then analyzed with the help of ETABS V13.1 software.

- 3 Dimensional structure modeling

Modeling in the study used ETABS V.13 software and in accordance with the planning drawings and building real conditions. The buildings are divided into three, namely building A, sky bridge, and building B. These three buildings do not become a single unit which is expected to avoid the concentration of forces that can occur if the building is integrated or commonly called

dilation. In the initial stage in modeling is to define the structural material used and the dimensions of the cross-section of structural elements from the frame system (beam-column), floor slabs, and structural walls. The dimensions of each structural element are defined according to the plan drawing, after all existing structural elements have been defined and then applied to the structure model. Non-structural elements such as floor coverings, electrical and mechanical are considered to be a burden on the structure.

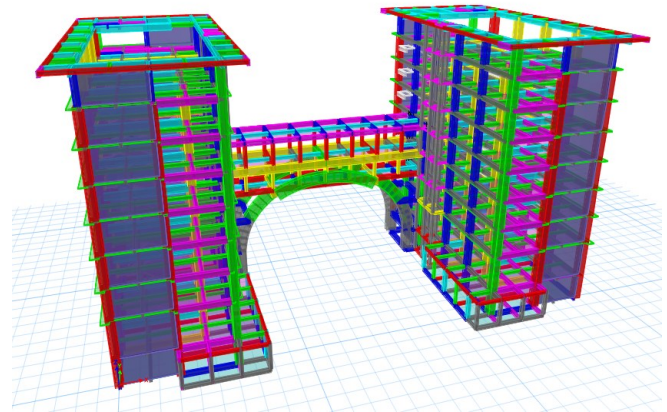

Fig. 5. Display 3-dimensional modeling using ETABS software.

B. Analytical method

- Structure load

Accumulated loads occur in the structure of the effects of Live Load, Super Imposed Dead Load, and structural loads.

TABLE II. DESCRIPTION OF THE BUILDING

Floors	Loading (kN)			TOTAL (kN)
	Self Load	ADL	LL	
Base	10998.6	884.1	1194.4	13077.2
L1	15574.3	1457.4	1165.0	18196.7
L2	15909.0	1416.4	1130.2	18455.6
L3	16276.6	1171.5	1310.1	18758.2
L4	18116.3	1179.8	1319.1	20615.2
L5	15254.5	1206.8	1348.1	17809.4
L6	13173.9	1025.0	1152.5	15351.5
L7	13173.9	1025.0	1152.5	15351.5
L8	12261.7	1025.0	1152.5	14439.2
L9	7677.4	499.9	330.6	8507.9
STRUCTURE LOAD				160562.3

- Earthquake data

The earthquake load must adjust to the type of land on which the building was erected. At the research location it is assumed that the soil classification is moderate (SD). With the data provided on the page <http://puskim.pu.go.id/> as follows:

Location : Jl. Farmako, Sekip, Sleman Regency, Special Region of Yogyakarta.

Coordinate : -7.769082, 110.374190

Value of S1 = 0,481

Value of Ss = 1,156

Value of Fa = 1,038

Value of Fv = 1,572

• Spectrum response design

Response spectrum (RS) is a spectrum that is presented in graphical form plots between periods of vibrating T structures, versus their maximum responses for a certain damping ratio and earthquake load. Maximum response can be the maximum deviation (Spectral Displacement, SD), maximum speed (Spectral Velocity, SV) or acceleration maximum (Spectral Acceleration, SA) a mass of structures with a single degree of freedom. Based on the SNI 1726: 2012 earthquake map for the location of the building, the Ss value was obtained at 1.156 g while the S1 value was 0.481 g. with the calculation referring to the applicable regulations, the SDS and SD1 values are 0.799 g and 0.504 g, respectively. The response spectrum graph is shown in Fig. 6.

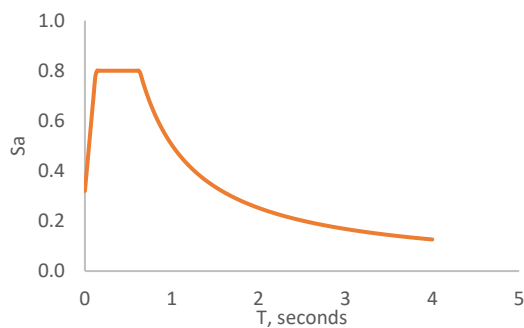

Fig. 6. Design spectrum response (medium soil)

• Structure fundamental period

Based on SNI 1726-2012 period fundamental structure T may not exceed the results of the coefficient for the upper limit in the calculated period (Cu) and the fundamental period of the Ta approach must be determined from the predetermined equation. The period values from the results of the analysis using the ETABS program are shown in Table III.

TABLE III. STRUCTURE PERIOD

Period, T	X-Axis	Y-Axis
T _{approx}	1.426	1.426
T _{max}	1.9963	1.9963
T _{gross}	0.6	0.6
T _{crack}	0.825	0.825

• Seismic shear force

The first seismic base shear (equivalent equivalent) of the building is obtained through the calculation of seismic shear coefficients (Cs) and total structure weight (Wt), Equation (2). The shear force is distributed to each floor according to the proportion following the formula required in SNI 1726: 2012, Equation (3) and Equation (4).

$$V = C_s \cdot W_t \tag{2}$$

$$C_{vx} = \frac{w_x h_x^k}{\sum_{i=1}^n w_i h_i^k} \tag{3}$$

$$F_x = C_{vx} \cdot V \tag{4}$$

With V is the basic shear force of the building; Fx is the lateral force due to the earthquake; Cvx is a vertical distribution factor; and k is constants whose magnitude is determined based on the period value of the structure.

VI. RESULTS AND DISCUSSION

Displacement data is 4 end points of building B, indicated by codes J-12, J-14, J-42 and J-44 (Figure 7). The value of displacement and drift ratio are taken from the response of the structure due to the load of the Response Spectrum and Equivalent Static on the X-axis and Y-axis.

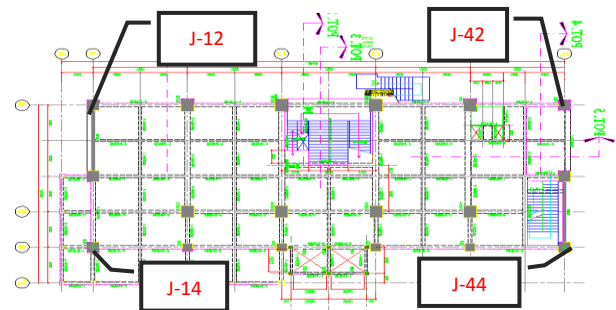

Fig. 7. Review point of displacement value

It can be seen in Fig. 8, 9, 10 and Fig. 11 that all the floors in the infilled frame structure are still in a safe condition, this is indicated by the indicator value of the interstory drift on each floor which is still within the permit limit for the X axis and Y axis. Additional stiffness contributed by the presence of a fill wall in the fill frame model can reduce the amount of displacement in the outer connections of each floor. The results are similar to those of Tidke and Jangave (2016) which state that wall pairs are capable of making drifts on smaller filler frame models than open frames. Whereas, at the open frame structure shows that interstory drift on the Y axis has exceeded the permit limit. Moreover, when compared between the open and infill frame models in both the X-axis and Y-axis directions, the presence of a fairly regular fill wall in the infill frame model is also able to homogenize the intersection points on each floor.

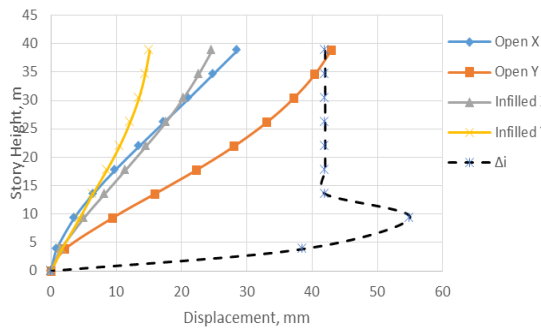

Fig. 8. Displacement curves on building joints spectrum response loads

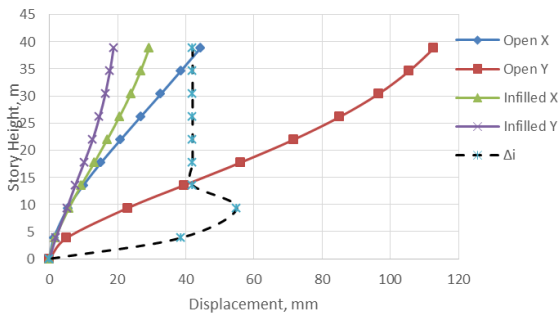

Fig. 9. Displacement curves on building joints static equivalent loads.

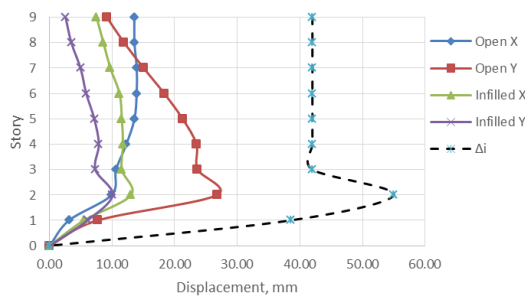

Fig. 10. Intersotry drift spectrum response loads

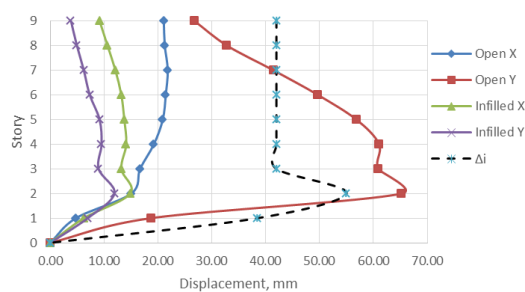

Fig. 11. Intersotry drift Static Equivalent Loads.

TABLE IV. SEISMIC DISTRIBUTION ON EACH FLOOR

Floor	Open Frame		Infilled Frame	
	W	V	W	V
9	739402	1547.035	850.7928	1761.18
8	1278,79	3379.61	1443.923	3808.42
7	1374487	5009.107	1535.148	5609.07
6	1374487	6319.551	1535.148	7057.15

5	1592677	7494.897	1780.939	8357.48
4	1845663	8493.176	2061.52	9460.68
3	1687554	9108.085	1875.815	10136.94
2	1618617	9450.832	1845.558	10523.6
1	1605134	9543.64	1819.668	10627.7
0	1232772	9543.64	1307.715	10627.7
Total	14349,58	69889.57	16056.23	77969.92

Table 4 shows that the value of shear force on the infill frame structure on all floors is greater than the value of the shear force on the open frame. The filler wall is proven to be able to add stiffness to the infill frame structure model. Increased stiffness is followed by increasing the earthquake force on each of these floors. The force of each floor is directly proportional to the value of the story shear which is the cumulative earthquake load from each floor, as shown in Fig. 12 and Fig. 13.

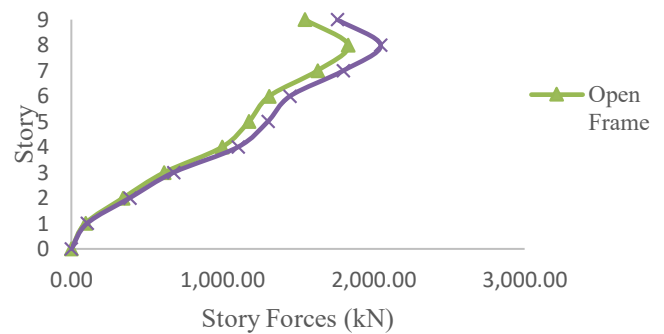

Fig. 12. Equivalent static earthquake force from each floor

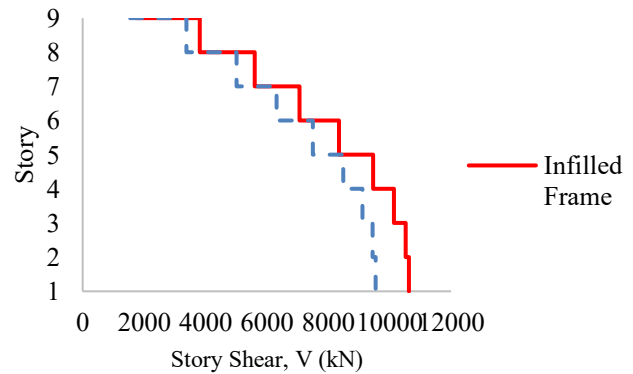

Fig. 13. Equivalent static earthquake shear force

V. CONCLUSION

Based on the results of the analysis, it was concluded that the Postgraduate Faculty of Medicine building located in the Special Region of Yogyakarta on the spectrum response load was still safe for both models with interstory drift values still not exceeding the permit limit. But on equivalent static loads, structures with open frame models have an interstory drift value that exceeds the permit limit. The addition of a filler wall has a significant effect on the value of the shear force and drift ratio that occurs. The infill wall added to the structure model increases the stiffness of the building so that it can reduce the drift ratio value that occurs.

REFERENCES

- Ambrose, J., & Vergun, D. Design for Earthquakes. Canada: Wiley & Sons, Inc. 1999.
- BSN. SNI 1726:2012 Tata Cara Perencanaan Ketahanan Gempa Untuk Struktur Bangunan Gedung dan Non Gedung. Badan Standarisasi Nasional, Bandung, 2012
- Dewobroto, W., Evaluasi kinerja bangunan baja tahan gempa dengan SAP2000. Jurnal Teknik Sipil, 3(1), pp. 7-24. 2006.
- Dorji, J., & Thambiratnam, D. P. Modelling and analysis of infilled frame structures under seismic loads. The Open Construction & Building Technology Journal, 3, pp. 119-126. 2009.
- Lindeburg MR., & McMullin KM. Seismic Design of Building Structures (10th ed). Belmont: Professional Publications, Inc. 2011.
- Pranata, Y. A., Evaluasi kinerja gedung beton bertulang tahan gempa dengan pushover analysis. Jurnal Teknik Sipil, 3(1), pp. 41-52. 2006.
- Prawirodikromo, W. Seismologi Teknik dan Rekayasa Kegempaan. Yogyakarta: Pustaka Pelajar, 2012.
- Sameer, P., & Gore, P. N. Study Of Seismic Analysis And Design Of Multi Storey Symmetrical And Asymmetrical Building. International Research Journal of Engineering and Technology (IRJET), 3(1), 2016, pp.732-737.
- Schodek, D. L. Structure (2nd ed). New Jersey: Prentice-Hall, 1999.
- Tanjung, J., & Maudiawati, M. Studi Eksperimental tentang Pengaruh Dinding Bata Merah Terhadap Ketahanan Lateral Struktur Beton Bertulang. Journal of Civil Engineering, 23(2), pp.99-106. 2016
- Tidke, K., & Jangave, S. Seismic Analysis of Building with and Without Infill Wall. International Journal of Innovative Research . 2016

The Influence of Soil Parameter to the Retarding Factor of Watershed

1st Gatut Bayuadji*

Doctoral Program on the Department of Water Resources,
Faculty of Engineering
University of Brawijaya
Malang-Indonesia
* gbayudji75@gmail.com

2nd Rispiningtati

Department of Water Resources,
Faculty of Engineering
University of Brawijaya
Malang-Indonesia
rispingtati@yahoo.ca

3rd Lily Montarcih Limantara

Department of Water Resources,
Faculty of Engineering
University of Brawijaya
Malang-Indonesia
lilymont@ub.ac.id

4th Pitojo Tri Juwono

Department of Water Resources,
Faculty of Engineering
University of Brawijaya
(of Affiliation)
Malang-Indonesia
pitojo_t@ub.ac.id

Abstract—The retarding factor determines the decay factor that has an impact on the time scale of the soil water content of watershed. In many works, that is a significant variable for drawing reliable flood thresholds. Nowadays, the empirical formula of the retarding basin factor is built only based on the watershed morphometric. This work made a review of articles published in scientific journals, conference papers, and books to determine the dominant soil parameter to retarding factor of watershed. Based on the results of the review, previous researchers had a unity of opinion that the soil texture, effective porosity, and conductivity hydraulic can be used to evaluate the watershed hydrogeological affect sensitivity to the retarding factor. This paper is expected to improve understanding of watershed behavior in holding water based on the influence of the soil factor.

Keywords—soil, decay factor, retarding basin factor, watershed.

I. INTRODUCTION

The retarding or storage factor of watershed determines the decay factor that has an impact on the time scale of soil water content. In the theory of synthetic unit hydrograph, there is described that the decay coefficient is controlled by the retarding or storage factor of watershed (Anggraheni and Sutjiningsih, 2016; Baltas et al. 2007). It has relation pattern that is generally expressed in the form of exponential formula (Anggraheni and Sutjiningsih, 2016).

Nowadays, the empirical formula of retarding factor of watershed is built based on the morphometric variables that are watershed area, river length, river gradient, source frequency, source factor, and drainage density (Harto, 1993; Lee et al. 2013), or time concentration (Bracken et al. 2008). However, further, the investigation about the influence of soil parameters on the retarding factor of watershed has not been researched. It needs to be researched because the difference in soil type in each watershed around the world, it will give a varied response to the ability of watersheds in holding soil water content. Where, in theory and application of flood-rainfall threshold, soil water content is often the determining variable in predicting flooding.

The main objective of this paper is to review some related articles for determining the influence of the watershed soil parameter as a hydrogeological effect on the retarding basin factor. This paper is expected to improve understanding of watershed behavior in holding water based on the influence of the soil factor.

II. LITERATUR REVIEW

The empirical formula of the retarding basin factor by using the parameter of watershed morphometric is also found by Harto (1993). The formula is like the part of Gama I synthetic unit hydrograph development which the storage factor is functioned as the determinant variable of unit hydrograph recession that is based on the exponential (1) and it is regarding the van Dam research (1979). Generally, the storage factor is classified into 2 parts that are the storage factor for analyzing the direct flow and inter-flow and the recession of base-flow. The two empirical formula of the Gama I storage factor has the non-linear relation (exponential equation) with the watershed morphometric. The empirical formulas are presented as in (1) until (4) below.

$$Q_t = Q_p \cdot d$$

$$d = e^{-K \cdot t} \quad (1)$$

where Q_t = discharge that is calculated in the time of t after Q_p (m^3/s), Q_p = discharge on that time ($t = 0$), (m^3/s), d = decay factor (-), K = storage factor ($hour^{-1}$), and t = time unit (hour)

$$K = \frac{0.5617 A^{0.1798} D^{0.0452}}{S^{0.1146} SF^{1.0897}} \quad (2)$$

$$K = 100(16.5395 + 0.6578F^7 - 17.0379SN - 1.911D)^{0.5} \quad (3)$$

where K = storage factor ($hour^{-1}$), A = watershed area (km^2), S = river gradient (m/km), SF = source factor (-), D = drainage density (m/km^2), F = drainage frequency (-), and SN = source frequency (-).

The variables of the watershed area and drainage frequency have the influence that is proportional to the watershed storage factor. It means that if the value of variables is increasing, it will give the indicator of watershed ability is also increasing in holding water. However, for the variable of river gradient, source factor, and source frequency have the reverse influences. Therefore, the bigger variables will decrease the watershed ability to hold water; however, mainly for the variable of drainage density, the relation pattern that is formed is not consistent. The formula of storage factor (2), the storage factor has a proportional relation but on (3) has reversed relationship.

The watershed area can be used as a guide to the magnitude of the role of a watershed storage system, as explained in the storage concept or theory. If the watershed is wider, so the ability of the watershed to hold water is also greater. The drainage frequency describes the amount of drainage density based on the segment number of the river. If a watershed has a fixed river length, but the segment number of the river is increasing, it means that the river system shows a tendency for a system that consists of rivers with a shorter average length of river segment. It causes the results in reducing the flow of groundwater flow into the river system or if the drainage frequency value is greater, so the retardation factor in the watershed aquifer will also increase. The source frequency can be used as a guide to the magnitude of the role of water sources that are originating from the first order of the rivers which contributes to the quantity of river flow. If the source frequency value is greater, the groundwater flow rate will increase, or the ability of aquifer watershed to hold the water to be going to decrease. A similar thing can be used to explain the effect of the drainage density and the source factor. The difference is that the drainage density parameter is more oriented to the even distribution of rivers in all the watersheds, while the source frequency and the source factor parameters are more oriented to the role of the first order of the river. The river slope parameter is identical to describe the hydraulic gradient which affects the rate of drainage of the groundwater flow to the river system. This means that the bigger the slope parameter of the river will reduce the ability of watershed aquifers to hold water.

According to Chow *et al.*, (2013) and Indarto (2010), the infiltration is specifically controlled by the factors of soil water movement. Based on the Darcy Law (1856) and regarding (4) is supposed that the soil properties give the significant effect of the watershed storage factor.

$$q_s = -K \partial H / \partial s \tag{4}$$

where q = volume of outflow from soil and s is the flow direction (m/s), K = hydraulic conductivity (m/s), and $\partial H / \partial s$ = hydraulic gradient.

The bigger hydraulic gradient and hydraulic conductivity will decrease the watershed availability to hold water in the aquifer.

III. METHODOLOGY

The methodology consists of the articles review to discuss the influence of the watershed soil parameter as a hydrogeological effect on the retarding basin factor.

IV. RESULT AND ANALYSIS

A. The Condition of Initial Soil Moisture and Rainfall Threshold

According to Martina *et al.* (2006), Avila *et al.* (2015), and Golian *et al.* (2010), the flood warning can be determined based on the rainfall identification that is needed to produce a flood. In the previous research, the relation between flood and rainfall is analyzed by only using the total daily rainfall without considering the initial condition (Avila *et al.* 2015; Santos and Fragoso, 2016). Fig. 1 presents flood associated rainfall for different watershed regime (Froidevaux *et al.* 2015). Fig. 1a and Fig. 1b describes that flood occurrences were triggered by small value rainfall events and it tends to be associated with higher values of long-term (D4-14) rainfall for non-glacial watershed regime. That is in contrast to the glacial watershed regime where flood occurrences are triggered by small value rainfall during dry periods, because of the effect of melting ice and making it tend to be saturated. Furthermore, this situation emphasizes that the soil water content antecedent conditions also determine the quantity of trigger rainfall will cause flooding event (Fig. 1c & Fig. 1d).

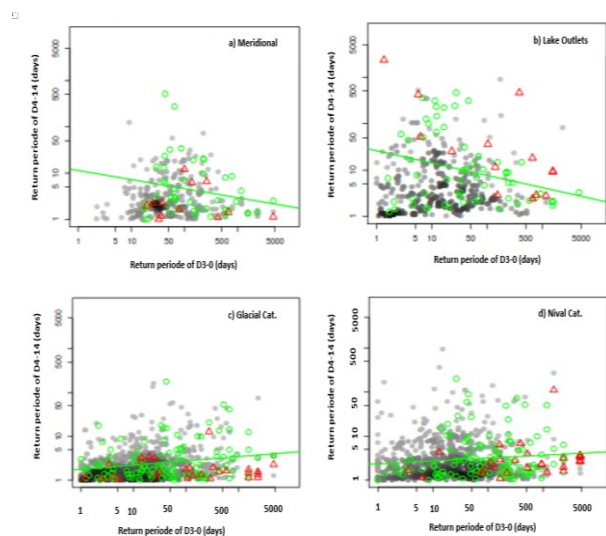

Fig. 2. Flood associated rainfall for different watershed regimes. Gray dots are annual flood. Flood return period for 5-years are indicated by green dots and Flood return period for 20-years are indicated by red triangles. Green lines show the linear regression of the flood return period for 5-years. Source: Froidevaux *et al.* (2015).

Fig 2. describes that when the overland flow or flood has been formed, this condition reflects that the soil water content (reservoir) has been exceeded due to the presence of antecedent rainfall that has high intensity (Martina *et al.* 2006). The condition emphasizes that there is a non-linear relationship between soil water content and saturated area ratio to generate runoff or flood.

Fig. 3 shows that the flood occurrences are indicated related by AAR till to 15 days with the percentage are larger than 78%. In addition, it needs to highlight that most of the flood occurrences are related to AAR between 5 and 7 days. Because they have range percentage for the four different combinations AR with ARR 5 and 7 days between 84 to 88 % dan 81 to 85% respectively. So, it means that the antecedent conditions of rainfall (indirectly of the soil water content) have a significant impact on flood occurrence.

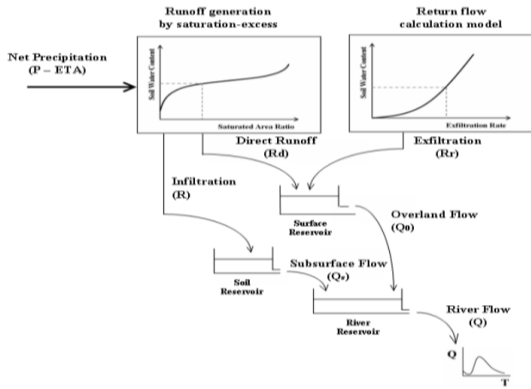

Fig. 3. The schematic representation of the lumped TOPKAPI hydrological model according to Lin and Todini, 2002. Source: Martina et al. (2006).

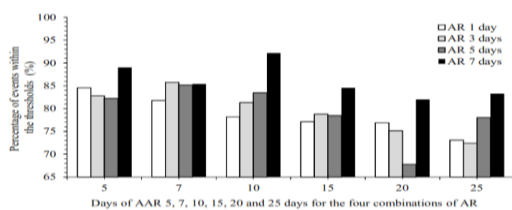

Fig. 4. The percentage of flood events within the threshold. Source: Avila et al. (2015).

B. Determination of Soil Parameter

Each soil type has a different ability to store and drain in response to the same infiltration as input to the soil profile. The process of evapotranspiration and water moving through the slope drainage system is decreasing the amount of available gravitation water on the soil pores, so there are more empty pores. In that situation, the time scale of soil water content mainly depends on soil hydraulic properties, namely soil water retention based on water tension, hydraulic conductivity, soil texture, porosity (Fig. 4) (Saxton and Rawls, 2006).

The soil water content is determined by pores volume that is filled by water. The bigger soil pore volume value, so the ability of soil in the infiltrating of water from rainfall and ability to hold water is more increase (Indarto, 2010). According to Saxton and Rawls (2006), the soil texture factor also influences the amount of water that can be bound on some conditions of soil water content (Fig. 4). Soil with clay texture is tending to have a higher percentage of water content than the sandy texture because its size of mineral particle dan pore space is big, and porosity is small. Besides, sand has faster saturated than clay texture.

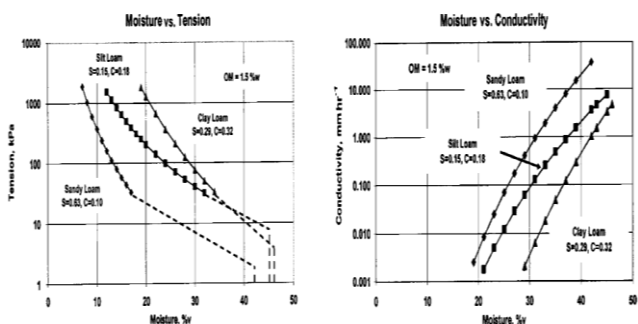

Fig. 5. Relationship between soil moisture content and tension & conductivity based on soil texture and organic matter. Source: Saxton and Rawls (2006)

V. CONCLUSION AND RECOMMENDATION

Based on the literature review and discussion above, it can be concluded that the antecedent rainfall as indirectly of the soil water content has a significant impact on the flood. It is strengthening the assumption that antecedent soil water content is an important variable in the characterization of a flash flood and/or flooding.

The retarding basin factor depends on the ability of the soil to hold water in the soil profile and depends on soil hydraulic properties that mainly influenced by texture, effective porosity of soil, and hydraulic conductivity.

ACKNOWLEDGMENT

The authors gratefully acknowledge to anonymous reviewer for the valuable comments and suggestions.

REFERENCES

Anggraheni, E., and Sutjiningsih, A., D., "Effectiveness of hypothetical retention ponds simulation on the Integrated Flood Management System," unpublished. [Paper presented at The International Conference of Associations of Indonesian Hydraulic Engineer: Water Resilience in a Changing World, Bali-Indonesia, 2016].

Avila, A., D., Carvajal, Y., E., and Justino, F., "Representative rainfall thresholds for flash floods in the Cali River watershed, Colombia," *J. Nat. Hazards Earth Syst. Sci.*, vol. 3, pp. 4095-4119, June 2015.

Baltas, E., A., Dervos, N., A., and Mimikou, M., A., "Technical note: determination of the SCS initial abstraction ratio in an experimental watershed in Greece. *J. Hydrol. Earth Syst. Sci.*, vol.11, 1825-1829, November 2007.

Bracken, L., Cox, L., and Shannon, J., "The relationship between rainfall inputs and food generation in South-East Spain. *J. Hydrology Process*, 22, 683-696, February 2008.

Chow, V., T., Maidment, and Mays, L., W., *Applied Hydrology*, 2nd ed., New York: Mc.Graw-Hill Professional, 2013.

Froidevaux, P., Schwanbeck, J., Weingartner, R., Chevalier, C., and Martius, O., "Flood triggering in Switzerland: the role of daily to monthly preceding precipitation," *J. Hydrol. Earth Syst. Sci.*, vol. 19, pp. 3903-3924, September 2015.

Golian, S., Saghafian, B., and Maknoon, R., Derivation of probabilistic thresholds of spatially distributed rainfall for flood forecasting. *J. Water Resources Management*, vol. 24, pp. 3547-3559, March 2010.

Harto. *Hidrologi: Teori, Soal, Penyelesaian*. Yogyakarta: Nafiri Offset, 1993.

Indarto. *Hidrologi, Dasar Teori dan Contoh Aplikasi Model Hidrologi*. Jember: Bumi Aksara, 2010.

Lee, J., Yoo, C., and Sin, J., "Theoretical background and empirical equations of basin concentration and storage coefficient," *J. Korea Water Resources Association*, vol. 46(2), pp. 155-169, 2013.

Martina, M., Todini, E., and Libralon, A., "A bayesian decision approach to rainfall thresholds-based food warning," *J. Hydrol. Earth Syst. Sci.*, vol. 10, pp. 413-426, 2006.

Santos, M. and Frago, M., "Precipitation thresholds for triggering floods in the Corgo Basin, Portugal," *J. Water*, vol. 8, pp. 1-11, 2016.

Saxton, K., E., and Rawls, W., J., "Soil Water Characteristic Estimates by Texture and Organic Matter for Hydrologic Solutions," *J. Soil Science Society*, vol. 70, pp. 1569 - 1578, 2006

Water Quality and Function Feasibility of Babon River in Semarang, Central Java, Indonesia

1st R. Sarah Wahyudi
Environmental Engineering Dept.
Diponegoro University
Tembalang, Semarang, Indonesia
rianwahyudi9@gmail.com

3rd P. Hary Subagya
Studi Teknik Consultant
Semarang, Semarang
harybagya@yahoo.com

2nd S. Imam Wahyudi
Civil Engineering Dept.
Sultan Agung Islamic University
Semarang, Indonesia (Correspondence Author)
wahyudi@unissula.ac.id

4th N. Andy Hermawan
Studi Teknik Consultant
Semarang, Semarang
novianandyhermawan@gmail.com

Abstract— *The Central Java Province has many watersheds which it's water quality still unknown, and also water class and function. Babon Watershed is one of them, and located at north slope of Ungaran Mount. The main river only is about 33,76 km length. Base on its function, from upstream to downstream, Babon Watershed can be divided into 8 segments. According to the analysis results obtained that in segment number I, II, III of Babon Watershed is recommended to function in class II, while segments number IV, V, VI, VII, VIII are recommended to function in class III.*

Keywords—river, water quality, BOD, COD

I. INTRODUCTION

Babon River is one form of ecosystem that is divided into upstream, middle and downstream areas. The upstream area is dominated by dryland and forest farming activities, the middle area by settlements and in the downstream region is dominated by industry and settlements. In line with the development of the community in the Babon River Basin, various life orders have changed rapidly following various community needs. One of the effects of these changes is the pattern of utilization of natural resources around the river. The desire to utilize natural resources to the fullest, generally paying less attention to the effects that will arise later on.

Indonesian Government Regulation No. 82 of 2001 concerning Management of Water Quality and Water Pollution Control stated that to ensure desired water quality according to its designation to remain natural, it is necessary to carry out efforts to manage water quality. Efforts to manage water quality in rivers, among others, by determining the capacity of the river, determine the designation of the river accompanied by the application of water quality standards.

The general objective to be achieved is the determination of the water class and the calculation of the capacity to load pollution of the Babon River.

II. METHODS

Data collection of river water quality is done by taking samples on the representative location. The parameters analyzed included physical parameters (TDS, TSS, temperature, DHL, brightness), inorganic chemical parameters (pH, BOD, COD, total P, NO₂, NO₃, N total, NH₃, Cl, F,

Sulphate, H₂S, chlorine free, sulfur as H₂S), organic chemical parameters (oil-fat, detergent as MBAS, phenol), biological parameters (fecal coliform and total coliform).

Calculation of pollution levels using Pollution Index Method as in Kep-MENLH No. 115/2003. The method provided to assess and to decide the quality of water level for a utilization allocation. Then, an action can be made to improve quality due to the presence of polluting compounds. The pollution index includes various independent and meaningful quality parameters.

Water sampling is carried out to determine the condition of water quality from upstream to downstream area. Sampling is done in each segment by purposive sampling method. To decide water sampling representative, It consider to access available, cost and time. Fig. 1 is describes the location of sampling of river water and wastewater samples from point sources.

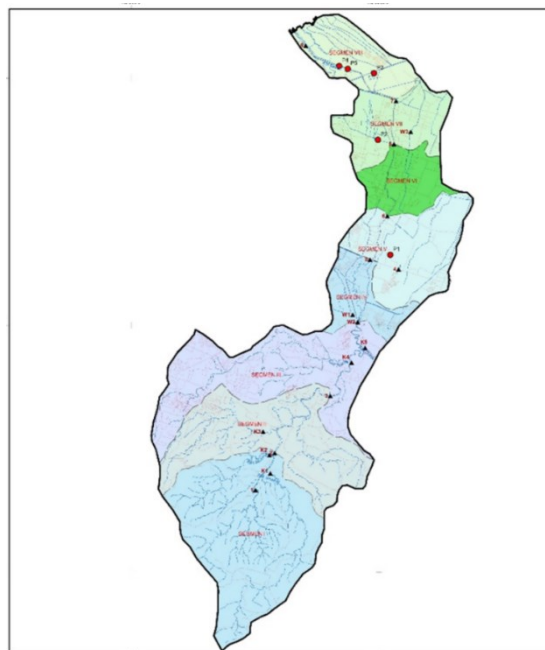

Fig. 1 Sampling Location

In addition to river water quality sampling, wastewater samples from point sources (several industrial locations) were also taken. The types and locations of sampling are shown in the following table.

TABLE I. SAMPLING POINTS

No.	Name	Segment	Location
1.	Point P1	V	Outlet of slaughterhouse, Pedurungan, Semarang
2.	Point P2	VII	Outlet of PT. Horison Gil, Kudu, Semarang
3.	Point P3	VIII	Outlet of PT Rodeo, Demak
4.	Point P4	VIII	Flavoring Factory, Terboyo Industrial Area, Semarang
5.	Point P5	VIII	Leather Factory, Terboyo Industrial Area, Semarang

III. DESCRIPTION OF LOCATION

Babon River or “Kali Babon”, passes through 3 administrative regions, namely Demak Regency, Semarang Regency and Semarang City. (Statistik, 2016). Babon River is often also called the Penggaron River in the upper of Pucang Gading dam. The Babon River has several tributaries that are quite large, namely Talang River, Sinanas River and Ketokan River. Whereas Kali Dolok and Kali Banjir Kanal Timur become separate watershed systems, but they are in a network controlled by sluice gates.

Babon watershed coverage is quite extensive, starting from several tributaries in Semarang Regency, meeting upstream areas in the Meteseh and Gedawang areas of Banyumanik District, Semarang until flowing eastward through the Pedurungan City of Semarang, Sayung District, Demak Regency, finally heading the area of Genuk Subdistrict and into the north coast of the Java Sea.

Babon watershed consists of three sub-watersheds, namely the Gung Sub-watershed (covering an area of 8,372 Ha), the Collector's Watershed (covering an area of 7,010 Ha) and the Lower Babon Watershed (an area of 9,202 Ha) with a main river length of 44, 679 km. Geographical position, Babon watershed is located between 60° 55’ 15”- 07° 10’ 00” SL (South Latitude) and 110° 24’ 42” - 110° 30’ 24” EL (East Longitude).

IV. RESULT AND DISCUSSION

Based on the results of processing of maps using a geographic information system, Babon River has 44.679 km length of upstream to downstream. The river water samples were taken by observing the watershed that forms the river fragments based on SNI 03-7016-2004 (Setiono et al., 2016). River segmentation was determined in advance to determine the area that affected the river with a certain distance. In Figs. 2 and 3 you can see the Babon watershed map, along with the division of segments starting from upstream to downstream.

Segment determination is based on consideration of water use (current and future), river morphology, topography, potential water sources and potential pollutant sources. By considering these conditions, the Babon River is divided into 8

division segments. Calculation of pollution load capacity uses a comparison of simulation. The simulation uses scenario 1 and scenario 2. In scenario 1 is a condition without pollutant load, while simulation scenario 2 is a condition of pollution. The load condition assessed according to class II river quality standards. This value is presented in Table II.

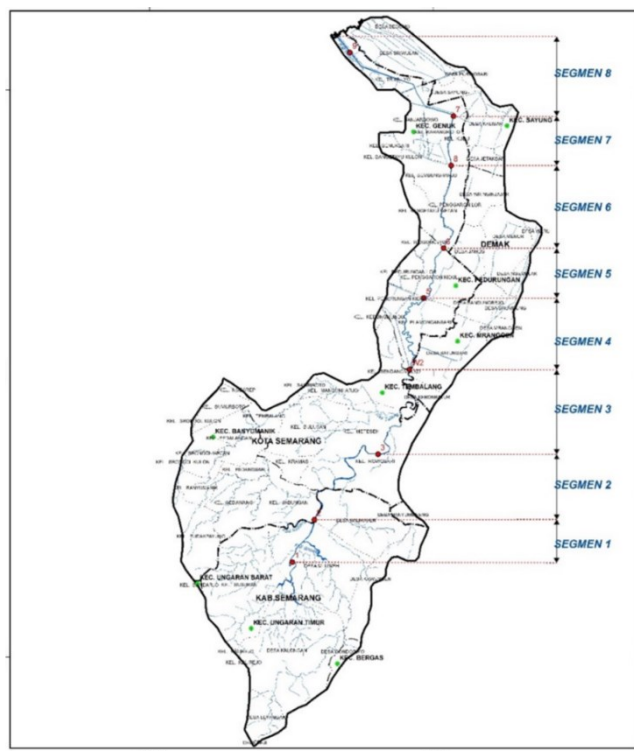
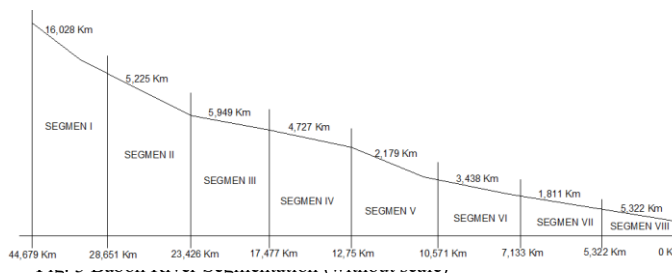

Fig. 2 Babon River Segmentation Map



Generally in the downstream areas TSS contamination loads tend to be higher. (Singh, Krishan, & Galkate, 2016). However, the graph in Fig. 4 shows the highest TSS value in the upstream area which is the upstream area of the dam. This is due to the high area of agricultural land in the upstream area according to data from the Central Statistics Agency.

The graph in Fig. 5 shows a significant increase in segment 8. This is due to the accumulation of previous segments as well as several point sources. The segment 8 or precisely in Genuk Subdistrict is found in a number of industries that have the potential to contribute to production waste, including point source textile industry (PT. Rodeo), fishing industry (PT.

Aorta), food / beverage industry (PT Kino and PT. Sukasari), industry cigarettes (CV. Living Heritage), and leather industry (PT. Puspita).

TABLE II. CAPACITY OF BABON RIVER POLLUTANT LOAD

Seg.	Distance (km)		TSS kg/day	BOD kg/day	COD kg/day
	Up	Down			
1	40,70	38,60	331,50	3,7	165,75
2	38,60	33,50	568,69	6,92	298,92
3	33,50	27,60	165,27	36,26	179,45
4	27,60	22,90	93,65	21,04	96,77
5	22,90	20,70	46,45	48,38	43,55
6	20,70	19,00	44,70	46,56	41,91
7	19,00	15,50	11,64	26,86	71,62
8	15,50	10,90	82,86	388,36	653,97

Similar to the BOD chart, the COD chart in Fig. 6 shows a significant increase in segment 8 due to accumulation in the previous segment and effluent in several industries. In addition, it can be seen that the COD contamination load for the upstream area is quite high due to the high Potential Domestic COD Pollution Load in the upstream area.

Based on the results of calculations shown in Table II and Figs. 4 to 6, it can be seen that the minimum and maximum capacity for each test parameter is in accordance with the existing river segment. For TSS parameters the minimum capacity is 11.64 kg / day in segment 7, BOD parameters are 3.69 kg / day in segment 1 and COD parameters are 41.91 kg / day in segment 6. The maximum capacity of TSS parameters is 568.69 kg / day in segment 2, BOD parameters of 388.36 kg / day in segment 8 and COD parameters of 653.91 kg / day also in segment 8.

The study resulting water classes proposed for each segment on the Babon River are as follows in Table III.

TABLE III. PROPOSED WATER CLASS FOR EACH SEGMENT

SEGMENT	PROPOSAL OF WATER CLASS
I	II
II	II
III	II
IV	III
V	III
VI	III
VII	III
VIII	III

According to the result in Table III considered that Class II is used for water recreation facilities/infrastructure, freshwater fish farming, livestock, and utilization for plants or other uses. While Class III is used for freshwater fish farming, livestock and irrigation.

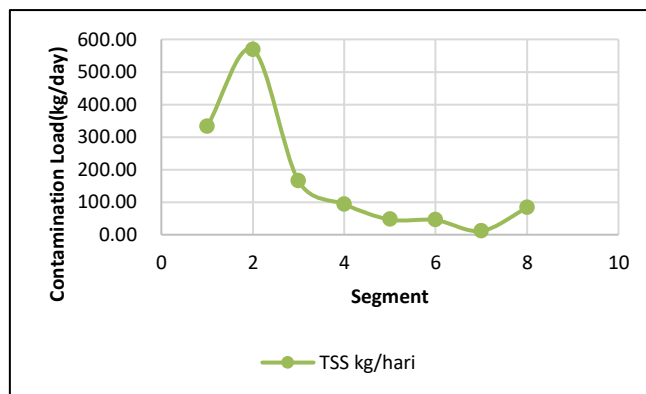

Fig. 4 TSS Parameter Capacity

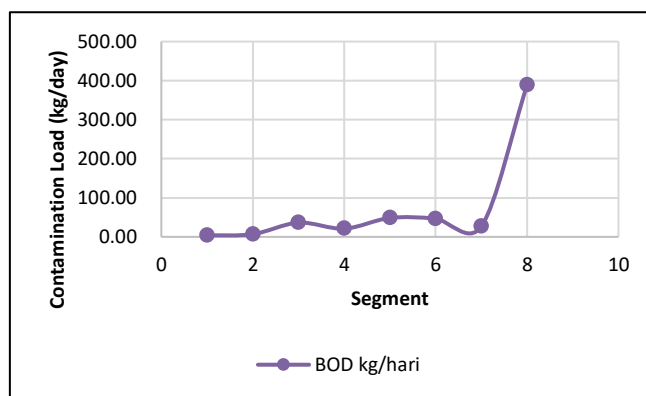

Fig. 5 BOD Parameter Capacity

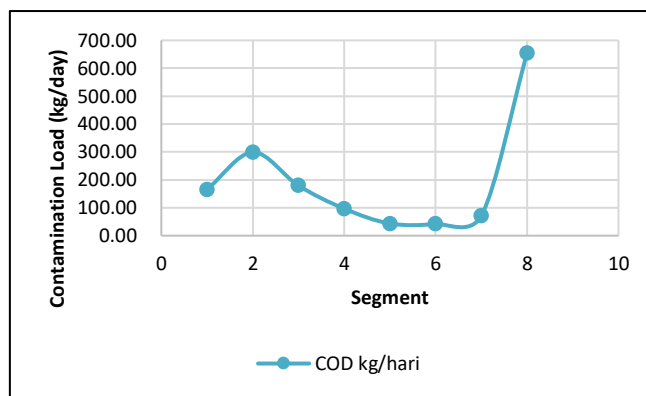

Fig. 6 COD Parameter Capacity

V. CONCLUSION

- 1) Base on land use and pollutant distribution, Babon river is divided into 8 segments.
- 2) The study resulting TSS parameter presents in the upper dam has large TSS value then gradually lower and stable, and finally TSS value increases closing to estuary area.
- 3) The value of BOD and COD tend from upstream to increase in the downstream or estuary.
- 4) In the upstream area class II is proposed, while water in the downstream area proposed to be utilized for class III.

ACKNOWLEDGMENT

Thank you addressed to the Environmental Agency (BLH) of Central Java Province. All Colleagues who supported this activity from Environmental Engineering Diponegoro University, Civil Engineering UNISSULA and and PT Studi Teknik Consultants.

REFERENCES

- Boogaard, F., Heikoop, R., Boer, E., & Palsma, M. (2017). Effective International Knowledge Exchange to Rehabilitate Rivers in Urban Delta's with RDM approach. In *MATEC Web of Conferences* (p. 13).
- Bsni. (2004). Tata cara pengambilan contoh dalam rangka pemantauan kualitas air pada suatu daerah pengaliran sungai.
- Bsni. (2009). *Air dan air limbah – Bagian 2 : Cara uji Kebutuhan Oksigen Kimiawi (Chemical Oxygen Demand / COD) dengan refluks tertutup secara spektrofotometri*.
- Christirani, S., Zaharin, A., & Kamil, M. (2015). Classification of River Water Quality Using Multivariate Analysis. *Procedia Environmental Sciences*, 30, 79–84. <https://doi.org/10.1016/j.proenv.2015.10.014>
- Effendi, H. (2016). River water quality preliminary rapid assessment using pollution index, 33, 562–567. <https://doi.org/10.1016/j.proenv.2016.03.108>
- P.Hary Subagya, Novian Andi, T. B. J. T. (2015). *Usulan Penetapan Kelas Air Kali babon*. BLH Prov. Jateng.
- S. Imam Wahyudi, Rick Heikoop, Henny Pratiwi Adi, Tom Overgaauw, Bram Schipper, R. P. (2017). Emergency scenarios in the Banger polder, Semarang City A case study to identify different emergency scenarios. *Water Practice and Technology*, 12(3), 637–648. <https://doi.org/10.2166/wpt.2017.067>
- Setiono, Hadiani, R., Erlangga, Edo, & Solichin. (2016). Rainfall Simulation at Bah Bolon Watershed with Backpropagation Artificial Neural Network Based on Rainfall Data Using Scilab. *Applied Mechanics and Materials*, Vol. 845, pp. 10–17.
- Singh, S., Krishan, G., & Galkate, R. V. (2016). Development of an Overall Water Quality Index (OWQI) for Surface Water in Indian Context, (January).
- Statistik, B. P. (2016). *Semarang dalam angka*. Badan Pusat Statistik Prov. Jateng.
- Wahyudi, S. Imam, H. P. A. (2018). Evaluating Environment , Erosion and Sedimentation Aspects in Coastal Area to Determine Priority Handling (A Case Study in Jepara Regency , northern Central Java , Indonesia). In *IOP Conf. Series: Earth and Environmental Science* 140 (pp. 1–7). <https://doi.org/0.1088/1755-1315/140/1/012042>.

Good Project Design Indicators for Educational Building in Surabaya

1st Laveda Nidya Irianti
Civil Engineering Department, Faculty
of Civil, Environmental, and Geo
Engineering
Institut Teknologi Sepuluh Nopember
Surabaya, Indonesia
nidyalaveda@gmail.com

2nd Mohammad Arif Rohman
Civil Engineering Department, Faculty
of Civil, Environmental, and Geo
Engineering
Institut Teknologi Sepuluh Nopember
Surabaya, Indonesia
arif.its@gmail.com

3rd Farida Rachmawati
Civil Engineering Department, Faculty
of Civil, Environmental, and Geo
Engineering
Institut Teknologi Sepuluh Nopember
Surabaya, Indonesia
farida.rachmawati@gmail.com

Abstract—*Design is an important part of the process to create a product, therefore a good design concept is needed. Good design is a concept which is commonly used in the context of urban design. The aim of the urban design is to deliver social sustainability values to the community such as by improving economic life, social relations, and providing safe, comfortable and easily accessible public spaces for all people regardless of physical ability. The concept of good project design have been implemented in several fields, such as technology, architecture, and urban planning. However, still limited has been conducted in the area of construction management. This paper investigated several indicators of a good design in educational building. Research variables were identified through an extensive literature review. Preliminary survey and pilot test were performed before the questionnaire survey to verify the variable as well as to ensure that the questionnaire has been well understood by the potential respondent. Data were analysed using mean to rank the stakeholders' perceptions from the government, consultants and communities as the end users. The results showed five highest criteria to measure a good project design for educational building in Surabaya.*

Keywords—*building, design, good project design*

I. INTRODUCTION

According to Whyte et al. (2005), design aims to convey ideas that can be used as products (services) or innovation processes. Design is an innovative use of knowledge-planned and provided for forming processes, environments, products, and services by rejecting measure on user needs. Design is an important part of the process of creating a product, so a good design concept is needed. Good design is commonly used in the context of urban design that is a design that focusing on the relationship between humans and places, accessibility and shape of cities, structures built and nature, and the process to ensure the success of a city (DETR and CABE, 2000).

The goal of a good urban design is to provide social sustainability values to the community, including improving economic life, social relations, and providing safe, comfortable and easily accessible public spaces for everyone regardless of physical abilities. One of the goals of urban design is that it is easily accessible to everyone regardless of physical abilities, which means it is in accordance with the objectives of several design concepts namely, Inclusive Design, Universal Design and Design for All.

Center for Universal Design stated that universal design principles can be used to evaluate previous designs, the design

process and educate designers and user about the products characteristics that are useful and environmental friendly. Whereas according to Waller (2015), inclusive design is a design implementation of the diversity of users and satisfies the necessary of more people. Design for All is described as "a design for human diversity, social involvement and equality".

As aforementioned, there is a concept in relation to participatory design which aims to involve all stakeholders in the design process. Participatory design is a design concept about the involvement of end users in the decision-making process with stakeholders such as engineers, designers, and decision makers to understand and satisfy their needs. (Sanders and Rim, 2002). The research conducted by Yu (2017) explains that the results of post occupancy evaluation on campus in Chongqing showed that students were more comfortable doing activities in the building with the concept of green building regarding air, lighting and ventilation conditions, but in terms of noise it was still disturbing. From this information it is necessary to do this research to get good design criteria. This paper describes good design factors which would be applied to educational building.

The educational building has specific needs compared to other buildings. The educational building is a building that is used to support the educational process. Where education is an important aspect of the lives of future generations. In improving the quality of education, need to be supported by the condition of a good and comfortable building, because the condition of the school building can affect the activities of students and teachers in the teaching and learning process. This suggests that the conditions of the buildings considered to be essential to support the quality of learning.

II. LITERATURE REVIEW

A. Urban Design

The goal of a good urban design is to provide social sustainability values to the community, including improving economic life, social relations, and providing safe, comfortable and easily accessible public spaces for all people regardless of physical ability (DETR and CABE, 2000). Urban Design principles including characters, continuity and closure, characteristic of public areas, ease of accessibility, legibility, suitability and diversity (DETR and CABE, 2000).

B. Universal Design

Universal design is the design of a product that can be used by all people, without the need for special adaptation and special design. Universal design is a concept that improve solutions about accessibility, usability of products and services for user with all ages and abilities, and the concept that avoid the specific design that only focuses on people with disabilities and the elderly (Palmer dan Ward, 2010). According to Center for Universal Design, Urban Design principles including: flexibility in use, equitable use, simple and intuitive use, low physical effort, size and space for approach and use, tolerance for error, and perceptible information.

C. Inclusive Design

Inclusive design is design of major products and services that can be accessed and can be used by many people without the need for special adaptations or special designs (The British Standards Institute 2005). Process on Inclusive Design including: allowing for iterativeness, specifying the context of use, discovering, understanding and translating the needs of the user, adapting and applying guidelines and standard, involving end users and stakeholders, evaluating design against requirement and test with real user (Vavick and Keitsch, 2010). According to Inclusive Design Toolkit, there are four phases in Inclusive Design: explore, evaluate, create, and manage.

D. Design for All

Design for All is a design concept that about the intervention in products and services that aim to show that everyone regardless of gender, age, and cultural background can participate in social activities, economy, culture with the same opportunities. There are several criteria for design for all, including: respectful, safe, healthful, functional, easy to understand, sustainable, affordable, and attractive.

E. Participatory Design

Participatory design is a design concept about the involvement of end users in the decision-making process with stakeholders such as engineers, designers, and decision makers to understand and satisfy their needs (Sanders dan Rim, 2002). Concept participatory based on the experience of users become an important component in the design development process. User experience becomes a source of inspiration and ideas that can be used as material for evaluation in the design work.

F. Safe Design

Safe design is a design that can keep users from the dangers, to perform the method of control in the entire design process. safe design prioritizes health and safety for the user (Safe Design Australia). Benefit of safe design including: reduced cost, innovation, improve useability and productivity, reduction in injuries and death, safer workplaces, compliance with legislation, and prevention-eliminating at the source.

G. Previous Research

Several studies on the concept of inclusive design have been perform in several fields. Vavik and Keitsch (2010) conducted a study of the relationship between social sustainability. The goal of this study is to show how universal design methods can contribute to social sustainability in

answering social life problems in society. Heylighen (2013) conducted research on developing an Inclusive design approach assumes that inclusiveness is in accordance with a good design concept. A design is said to be good when produced on the basis of information and experience between designers and people who use the designs. Yu (2017) explained that the results of post occupancy evaluation on campus in Chongqing showed that students were more comfortable doing activities in buildings with the concept of green building regarding air conditions, lighting, and ventilation, but in terms of noise it was still disturbing. Another study conducted by Kusumarini (2012) explained that the facilities in the malls in Surabaya such as signage, entrance, and circulation have been applied in accordance with a universal design approach but not optimal. Based on previous research, many studies have been carried out on the design concept. The discussion related to the concept of good project design in buildings is still limited. Based on the existing conditions, the design is made based on the perception of the designer, does not involve the user directly, so that it is not in accordance with the wishes and expectations of the user. Based on the previous research, the research variables obtained as in Table I.

TABLE I. RESEARCH VARIABLE

No	Criteria for Good Project Design	Source
1	Can be used by all user including people with disabilities	Center for Universal Design (2013), Burgstahler (2002), Vavik and Keitsch (2010), CABA dan DETR (2000), Siu and Wong (2002), Dischinger and Jackson (2006), Kadir and Jamaludin (2011), Chan and Lee (2008), Brown dkk (2010), Saito (2006)
2	Involving community participation in the design process	Vavik and Keitsch (2010), Sanders and Rim (2002), Dasgaard (2012), Waller et al. (2013), Chan and Lee (2008)
3	Has a characteristic as the identity of a building	CABA and DETR (2000)
4	Design becomes pride and prestige	Gokarakonda et al. (2018)
5	Design looks aesthetic	Inclusive Design Toolkit (2013), Brown et al. (2010)
6	Appropriate for user needs	Center for Universal Design (2013), Burgstahler (2002), Vavik and Keitsch (2010), CABA and DETR (2000)
7	Easy to understand	Center for Universal Design (2013), Burgstahler (2002), Vavik and Keitsch (2010), CABA and DETR (2000), Saito (2006)
8	Easy to use	Inclusive Design Toolkit (2013), Siu and Wong (2002)
9	Design must first be tested directly by the user	Vavik and Keitsch (2010), Waller et al. (2013)
10	Design can be changed according to user needs	Center for Universal Design (2013), Burgstahler (2002), Siu and Wong (2002)
11	Enabling users to interact with each other	Center for Universal Design (2013), Burgstahler (2002), CABA and DETR (2000)

12	Using materials that are not harmful to health	Center for Universal Design (2013), Burgstahler (2002), Vavik and Keitsch (2010), CABE and DETR (2000), Brown et al. (2010)
13	In accordance with applicable regulations	Vavik and Keitsch (2010), CABE and DETR (2000), Kadir and Jamaludin (2011)
14	Does not cause accidents for users	Center for Universal Design (2013), Burgstahler (2002), Vavik and Keitsch (2010), CABE and DETR (2000), http://designforall.org/design.php , Siu and Wong (2015), Brown et al. (2010), Hayes (2015)
15	Necessary to consider the location and orientation of buildings	Gene-Harn et al. (2017)
16	Using materials that can withstand the heat	Philokyprou et al. (2017)
17	Flowing air circulation inside and outside the room smoothly	Kalutara et al. (2017), Hassan (2016), Feige (2016), Bunz et al. (2016)
18	Design with clear lighting	Kalutara et al. (2017), Feige (2016), Bunz et al. (2016)
19	Design with spacious rooms	Kalutara et al. (2017), Akadiri (2012), Bunz et al. (2016)
20	Not cause noise	Kalutara et al. (2017), Akadiri (2012), Bunz et al. (2016)
21	Implementation of the building design can be implemented with cost-efficient	Waller et al. (2013), Hayes (2015), Heylighen (2016)
22	Implementation of the building design can produce energy efficiency	Center for Universal Design (2013), Burgstahler (2012), http://designforall.org/design.php , Waller et al. (2013)

III. METHODOLOGY

According to Arikunto (2010), the research method is "the method used by researchers in collecting research data". The data used in this study are primary data. Primary data is data obtained from the first source of individuals such as the results of interviews or the results of filling out questionnaires (Sugiarto et al., 2010).

A. Preliminary Analysis (Data Preparation and Cleaning)

Preliminary analysis is carried out by examining respondent's answers to the questionnaire; and checking whether there are unclear answers or missing answers. Prior to data analysis, the total research sample was verified and validated to ensure that the data was suitable for statistical analysis. Data preparation and screening consists of several steps such as data coding, analysis of lost data, and normality tests.

The first step of data analysis is to input answers on a computer using an Excel spreadsheet. After coding the data, the next step is analysis of lost data using screening data to check whether there are missing answer or not. The valid answer in the questionnaire is indicated by no missing answer and no missing data, therefore, the normality test could be analyzed further.

A normality test is a test carried out with the aim of assessing the distribution of data in a group of data or variables, whether the distribution of the data is normally distributed or

not. The normality test uses the Skewness Kurtosis test with the SPSS program. after doing a test for normality, it can be concluded that the value of Z Skewness and kurtosis < 2.58.

B. Descriptive Analysis

Descriptive analysis in this study are validity and reliability analysis, background analysis of the respondents, and the mean test.

Validity test using the Pearson Correlation technique. The testing criteria is indicated by the correlation coefficient. If the correlation coefficient (rxy) is greater than the r table value of 0.159, it means the item questionnaire is valid and is appropriate as a data collection tool. Reliability test was carried out using Alpha Cronbach technique. Where an instrument will be more reliable if the alpha coefficient is more than 0.60.

The background analysis of the respondents provided information relating to the characteristics of the respondents involved in this study. The mean test can be used to checking the performance of criteria according to the perceptions of respondents.

IV. RESULT AND ANALYSIS

A. Preliminary Analysis (Data Preparation and Cleaning)

After analyzing the data, it was found that there were no missing answers. It means the data is valid and is appropriate as a data collection tool. Next step is the normality test.

A normality test is a test carried out with the aim of assessing the distribution of data in a group of data or variables, whether the distribution of the data is normally distributed or not. The normality test uses the Skewness Kurtosis test with the SPSS program. after doing a test for normality, it can be concluded that the value of Z Skewness and kurtosis < 2.58, so that it can be said that the data is normally distributed.

B. Descriptive Analysis

Descriptive analysis in this study are validity and reliability analysis, explanation of the characteristics of the sample, and the mean test to checking the performance of criteria according to the perceptions of respondents.

Validity test is done using the Pearson Correlation technique. The testing criteria is if the correlation coefficient (rxy) is greater than the r table value of 0.159, it means the item questionnaire is declared valid and declared valid as a data collection tool. Based on the results of testing the validity of the instrument that all correlation values are greater than the r table value of 0.159. Thus the points of the statement above can be declared valid.

Reliability test was carried out using Alpha Cronbach technique. Where an instrument will be more reliable if the alpha coefficient is more than 0.60. After testing the alpha coefficient is 0.856, so the variable is declared reliable and is worthy of being used as a data collection tool.

After the data is declared valid, next step is explanation of the characteristics of the sample. The number of respondents in this study were 153 respondents, consisting of 39 consultants (25%), 24 government (16%). The community dominates the sample with 90 respondents (59%). Male respondents were around 89 people (58%), more than female respondents, only around 64 people (42%).

The perception analysis of respondents in this study was used to find out the answers of respondents. The results of respondents' perceptions obtained as in Table II.

TABLE II. RESULT OF RESPONDENTS PERCEPTIONS

Item	Variabel	Respondent							
		Overall		Consultant		Government		Communities	
		Mean	Rank	Mean	Rank	Mean	Rank	Mean	Rank
x14	Does not cause accidents for users	4.61	1	4.59	2	4.38	5	4.68	1
x13	In accordance with applicable regulations	4.60	2	4.56	3	4.54	1	4.64	3
x1	Can be used by all user including people with disabilities	4.59	3	4.51	5	4.46	3	4.66	2
x18	Design with clear lighting	4.57	4	4.62	1	4.29	7	4.62	5
x12	Using materials that are not harmful to health	4.56	5	4.54	4	4.33	6	4.63	4
x17	Flowing air circulation inside and outside the room smoothly	4.54	6	4.44	8	4.42	4	4.61	6
x6	Appropriate for user needs	4.53	7	4.46	7	4.50	2	4.58	7
x3	Has a characteristic as the identity of a building	4.35	8	4.49	6	4.08	12	4.36	12
x5	Design looks aesthetic	4.34	9	4.41	9	4.25	8	4.34	14
x8	Easy to use	4.29	10	4.18	13	4.17	10	4.38	11
x22	Implementation of the building design can produce energy efficiency	4.28	11	4.28	11	4.00	14	4.35	13
x16	Using materials that can withstand the heat	4.27	12	4.08	16	3.79	19	4.49	8
x4	Design becomes pride and prestige	4.25	13	4.38	10	4.21	9	4.21	17
x20	Not cause noise	4.25	14	4.00	19	4.13	11	4.39	10
x21	Implementation of the building design can be implemented with cost-efficient	4.23	15	4.26	12	3.96	15	4.29	15
x19	Design with spacious rooms	4.21	16	3.90	20	3.92	16	4.42	9
x11	Enabling users to interact with each other	4.17	17	4.13	14	4.04	13	4.22	16
x15	Necessary to consider the location and orientation of buildings	4.07	18	4.10	15	3.88	17	4.10	20
x7	Easy to understand	4.06	19	4.03	18	3.83	18	4.13	18
x2	Involving community participation in the design process	4.05	20	4.05	17	3.75	20	4.12	19
x9	Design must first be tested directly by the user	3.78	21	3.54	22	3.67	22	3.91	21
x10	Design can be changed according to user needs	3.72	22	3.69	21	3.71	21	3.73	22

According to Table II, it can be concluded that five highest criteria are:

1. Does not cause accidents for users, with a mean of 4.61. The community as a user feels that safe design is an important criterion in a building.
2. The applicable standard is an important aspect in the second rank with a mean of 4.60 and the government also thinks that is the same as the mean 4.54. Because if compliance with the standards can be ascertained on the design of the building is already comply with existing regulations.
3. Can be used by all user including people with disabilities. This criterion is ranked third with a mean of 4.59. The community also argues the same and makes the criteria ranked second with a mean of 4.66. Because communities feel that the design should be used universally, regardless of the user's physical limitations
4. Clear lighting, with a mean of 4.57. The respondents as a whole thought that lighting was an important aspect, reinforced by the opinions of consultants with a mean of 4.62. Consultants found that lighting is clearly a design that can make the user feel comfortable so it is an important criterion.
5. Using material that is not harmful to health with a mean value of 4.57. The overall respondents thought that these criteria were important aspects in the fifth rank. While consultants and the community agreed that these criteria is ranked in fourth position.

The educational building is a building that is used to support the educational process. Therefore, need to be supported by the condition of a good and comfortable building, because the condition of the school building can affect the activities of students and teachers in the teaching and learning process.

V. CONCLUSION AND RECOMMENDATION

Based on this research about Good Project Design Indicators for Educational Building in Surabaya, it was concluded as follows :

1. It was found that 22 indicators are relevant to be used in this research. It can be concluded that five highest criteria are :
 - a) does not cause accidents for users
 - b) the applicable standard is an important aspect
 - c) can be used by all user including people with disabilities
 - d) clear lighting, and
 - e) using material that is not harmful to health
2. Also there are differences in perception between categories (consultants, governments and communities) about the criteria of good project design in building educational

REFERENCES

- Abascal, J. and Nicolle, C. (2005). Moving towards inclusive design guidelines socially and ethically aware HCI. *Interacting with Computers*, 17, pp. 484-505.
- Akadiri, P.O., and Olomolaiye P.O. (2012), Development of sustainable assessment criteria for building materials selection. *Engineering, Construction and Architectural Management*, Vol. 19 Iss 6 pp. 666 - 687
- Arikunto, S. 2010. *Prosedur Penelitian Suatu Pendekatan Praktik*. Jakarta: PT. Rineka Cipta.
- British Standards Institute (2005). *British Standard 7000-6: Design management systems, Guide to managing inclusive design*. British Standards Institute, London, UK. Available from: www.bsi-global.com
- Brown, Z., Cole, R.J., Robinson, J. and Dowlatabadi, H. (2010). Evaluating user experience in green buildings in relation to workplace culture and context. *Facilities*, Vol. 28 No. 3/4, pp. 225-238.
- Bunz, K. R., Henze, G. P., and Tiller, D. K. (2006), Survey of Sustainable Building Design Practices in North America, Europe, and Asia. *Journal of Architectural Engineering*, Vol. 12, pp. 33-62.
- Centre for Universal Design. (2013). Terdapat pada: http://www.ncsu.edu/ncsu/design/cud/about_ud/about_ud.htm.
- Challal, A., dan Tkiouat, M. (2012). Qualitative Approach Risk Period in Construction Projects. *Journal of Financial Risk Management*, pp. 42-5.
- Chan, E.H.W. and Lee, G.K.L. (2009). Universal design for people with disabilities: A study of access provisions in public housing estates. *Property Management*, Vol. 27 No. 2, pp. 138-146.
- Cuff, D. (1991). *Architecture: The story of practice*. London: The MIT Press.
- Department of the Environment, Transport and the Regions (DETR) and Commission for Architecture and the Built Environment (CABE). (2000). *By Design: Urban Design in the Planning System: towards Better Practice*.
- Dischinger, M. and Jackson, J.M. (2006). Which future urban scenarios can we construct?. *Management of Environmental Quality: An International Journal*, Vol. 17 Issue: 4, pp. 409-420.
- EIDD-Design for All Europe. Terdapat pada: (<http://dfaeurope.eu/what-is-dfa/>).
- Feige, A., Wallbaum, H., Janser, M., and Windlinger, L. (2013), "Impact of sustainable office buildings on occupant's comfort and productivity", *Journal of Corporate Real Estate*, Vol. 15 Iss 1 pp. 7 – 34
- Gokarakonda S, van Treeck C, Rawal R, (2018). Influence of building design and control parameters on the potential of mixed-mode buildings in India, *Building and Environment*.
- Hadi, Sutrisno. 1991. *Analisa Butir untuk Instrument*. Edisi pertama. Andi Offset. Yogyakarta
- Hassan, O.A.B. (2016). An integrated approach to assessing the sustainability of buildings. *Journal of Engineering, Design and Technology*, Vol. 14 Issue: 4, pp. 835-850.
- Hayes, Jan. (2015). Investigating design office dynamics that support safe design. *Safety Science* 7, pp. 25–34.
- Heylighen, A. (2008). Sustainable and inclusive design: a matter of knowledge?. *Local Environment*. 13, 6, pp. 531–540.
- Inclusive Design Toolkit University of Cambridge. (2013). Terdapat pada: <http://www.inclusivedesigntoolkit.com/>.
- Ismail, I.S., Shamsuddin, S. and Sulaiman, A.B. (2008). An Evaluation of Residents Perception of Identity in Putrajaya New Town. *Jurnal Alam Bina*, 13 (4).
- Kadir, S.A. and Jamaludin M. (2012). Applicability of Malaysian Standards and Universal Design in Public Buildings in Putrajaya. *Procedia - Social and Behavioral Sciences* 36, pp. 659 – 669.

- Kalutara, P., Zhang, G., Setunge, S., and Wakefield, R. (2017). Factors that influence Australian community buildings' sustainable management. *Engineering, Construction and Architectural Management*, Vol. 24 Iss 1 pp. 94 – 117.
- Kusumarini, Y., de Yong, S., and Thamrin, D. (2012). Restroom Facilities of Malls in Surabaya: A universal interior design applications. *Procedia - Social and Behavioral Sciences* 68, pp. 504 – 514.
- Lopez-Perez, L, A., Flores-Prieto, J, J., and Rios-Rojas, C. (2019). Adaptive thermal comfort model for educational buildings in a hot-humid climate. *Building and Environment*.
- Mahgoub, Yasser. (2007). Architecture and the Expression of Cultural Identity in Kuwait. *Journal of Architecture* 12 (2): pp. 165–82.
- March, C. and Curwell, S., (2004). A methodology for selecting environmentally responsible materials. In: O. Ural et al., eds. *Sustainability of the housing projects, proceedings of the XXXII IAHS world congress*. Trento, Italy: IAHS/University of Trento, 40.
- Mundo-hernandez, J., Valerdi-Nochebuena, M.C., and Sosa-Oliver.J. (2015). Post-occupancy evaluation of arestored industrial building: A contemporary art and design gallery in Mexico. *Architectural Research* 4, pp. 330–340.
- Mustafa, F.A. (2017). Performance assessment of buildings via post-occupancy evaluation: A case study of the building of the architecture and software engineering departments in Salahaddin University-Erbil, Iraq. *Architectural Research*.
- Palmer, J and Ward, S (2010). The adaptable house in P Downtown (ed.), *Your home technical manual*, Fourth Edition edn, Department of Climate Change and Energy Efficiency, Canberra, pp. 52-56.
- Rohman, M.A., Doloi, H. and Heywood, C.A. (2017). Success Criteria of PPP Toll |Road Project from a Community Societal Perspective. *Built Environment Project and Asset Management*. 7 (1), pp. 32-44.
- Safe Design Australia. Terdapat pada: <http://www.safedesignaustralia.com.au/>
- Saito, Y. (2006). Awareness of universal design among facility managers in Japan and the United States. *Automation in Construction* 15, pp. 462 – 478.
- Sanders, E. B.-N. and Rim, S (2002). From user-centered to participatory design approaches. *Design and the Social Sciences*. J. Frascara (Ed.), Taylor & Francis Books Limited.
- Siu, K.W.M. and Wong, K.S.L (2015). Flexible design principles: Street furniture design for transforming environments, diverse users, changing needs and dynamic interactions. *Facilities*, Vol. 33 No. 9/10, pp. 588-621.
- Sugiarto, Siagian, D., Sunaryanto, L.T., dan Oetomo, D.S. (2001). *Teknik Sampling*. PT. Gramedia Pustaka Utama. Jakarta
- Undang-Undang Republik Indonesia nomor 28 Tahun 2002 Tentang Bangunan Gedung.
- Vavik, T. and Keitsch, M.M. (2010). Exploring relationships between universal design and social sustainable development: some methodological aspects to the debate on the sciences of sustainability. *Sustainable Development*, 18, pp. 295–305.
- Waller, S., Bradley, M., Hosking, I. and Clarkson, P.J. (2013). Making the case for inclusive design. *Applied Ergonomics*, xxx, 1-7.
- Whyte, J., Bessant, J. and Neely, A. (2005). *Management of Creativity and Design Within the Firm*. Imperial College London.
- Yu, X., Liu, L., Wu, Xu., Wu, Xiaolin, Wang, Z., Liu, Q., and Shi, G. (2017). On a Post-occupancy Evaluation Study of Effects of Occupant Behavior on Indoor Environment Quality in College Buildings in Chongqing. *Procedia Engineering* 205, pp. 623–627

The Effect of Green Design on Project Success : A Framework

1st Mira Anjar Gita
Civil Engineering
Sepuluh Nopember Institute of
Technology
Surabaya, Indonesia
miraanjangita@gmail.com

2nd Mohammad Arif Rohman
Civil Engineering
Sepuluh Nopember Institute of
Technology
Surabaya, Indonesia
arif@ce.its.ac.id

3rd Yusroniya Eka Putri
Civil Engineering
Sepuluh Nopember Institute of
Technology
Surabaya, Indonesia
yusroniya.putri@gmail.com

Abstract— *As the second largest city in Indonesia, Surabaya has quite big number of apartment building which is increasing from year to year. according to the research, apartment construction projects are said to be successful if they meet the requirements, namely time, cost and quality. in fact, the developers are still thinking about short-term successes and have not thought about the long term such as product success and market success. In connection with that, green design on apartment projects has the potential to influence the success of the project in the long-term aspects. This paper is the first step in the study to find out the conceptual framework regarding the relationship between green design and aspects of project success from the perspective of developers in Surabaya. This research can help stakeholders understand whether green design positively influences the success of apartment projects in the long-term aspects.*

Keywords— *developer, green design, market success, product success*

I. INTRODUCTION

Surabaya is the second-largest city in Indonesia. In this globalization era, there have been significant changes, especially in the field of construction development such as buildings, infrastructure, and transportation modes. The amount of development in Surabaya is increasing from year to year, including apartment construction projects. This vertical residential development began to shift thoroughly around the city of Surabaya. That causes developers should compete in building apartments. Starting from an apartment with a student concept, the concept of occupancy that is intended for middle-class people or new families as well as the concept of housing intended for residents who want to invest.

A project, including an apartment construction project, can be said to be successful if the construction is completed on time following the budget and good quality (Chan et al. 2002). This is called the "Iron Triangle". A project that seems successful in the client's view might be unsuccessful for contractors or developers (Tour et al. 2009). Meanwhile, the success of the project must be viewed from a different perspective from individual owners, developers, contractors and users, the general public and so on (Chan et al. 2009). In this study, the success of success is seen from the perspective of the developer. From a developer perspective, construction projects are considered successful when the 5 dimensions of success can be integrated by the success of the company; profitability success; main product success; secondary product success and branding success (Wai et al, 2012). The success of the project is a multidimensional concept consisting

of the success of project management (PMS), product success (PrS), and Market Success (MRS) (Al-Tmeemy et al, 2011). Thus the ideal development concept begins to shift towards development that is responsive to environmental problems, a development that can protect nature from pollution and deterioration in quality.

Green buildings can overcome environmental problems that not only offer opportunities to use existing resources more effectively but at the same time help create healthier buildings, can reduce negative impacts on the environment, while achieving significant cost savings over the life cycle of buildings (life cycle). Green design or known as 'Green Design' is a building that is related to energy, especially those that affect the environment (Kubba. 2017).

From the results above, he tends to still examine the relationship of green design to the success of the project. But no one has examined the relationship between green design and aspects of project success from the developer's perspective. Therefore research needs to be done to describe the concept of the influence of green design on the success of the project in the developer's perspective.

II. METHODOLOGY

Research methods are part of research design that includes data collection, analysis and interpretation used in research (Cresswell. 2014). The design of this study explains the purpose of the study, the main analysis techniques chosen, measurement, and data collection and the type of data collected and the method of data collection. The method to be used is confirmatory about the green design criteria from previous studies. Based on the literature carried out, the success variables and success variables of the project were obtained, the theoretical relationship between constructs.

In this study the population taken are employee developer in the city of Surabaya. Non-probability sampling technique because this sampling technique is more attached to the inherent material tested, namely the concept of green design and project success. From probability sampling technique, purposive sampling technique was chosen, this technique was deliberately chosen according to the researchers' consideration and not randomly because respondents who will be used as research samples were only the parties involved, namely Developers involved in building Apartment buildings who understood the existing green design concept. in the city of Surabaya.

The research method will be conducted by distributing questionnaires conducted by giving a set of written questions to the respondent. The measurement scale used is the Likert scale, which is a scale for measuring one's attitudes, opinions and perceptions. Perception assessment is divided into 5, starting from strongly disagree given weight 1 to strongly agree with weight 5.

This section will explain the conceptual aspects of Green Design and aspects of project success. This is explained because it is used to overcome research problems regarding theoretical frameworks. the five research constructs applied in this study are Green Design, product success (PrS) and market success (MS) aspects. These five constructs need to be defined to identify the principle and then determine the attributes to allow testing of the construct.

TABLE I. OPERATIONAL DEFINITION OF GREEN DESIGN

Variable	Indicator	Operational Definition	Source
Site Location	Location	New land clearing is measured by doing revitalization and development which are negative and unused because of the former construction.	[14] [8] [16]
	Atmospheric Condition	Temperature and high humidity throughout the year results in higher temperatures than comfort in the summer	[8] [16]
	Vertical Landscape	The existence of a landscape area in the form of vegetation that is free from the structure of buildings and simple structures of buildings above ground level or underground for new construction buildings, with a minimum area of 40% of the total land area as well as green open space.	[13] [8]
Efficiency Energy	Gas Emission	Global warming is a condition of increasing extreme temperatures that hit the world due to increased carbon gas emissions pollution which causes high levels of unnatural greenhouse gases in the Earth's atmosphere.	[13] [8]
	Lower Use of Energy	Renewable energy on the site also aims to encourage the use of new and renewable energy sources sourced from the location of building sites. Every 0.5% of the electricity needed by the building can be met by renewable energy sources	[8] [16]
	Renewable Energy	Renewable energy where energy that is abundant in nature and says that it consumes energy that does not cause a large effect on the environment or nature.	[8] [16]
Indoor Environment Quality	Natural Ventilation	Buildings that are located in tropical climates must consider as much as possible the ventilation	[8] [16]

Variable	Indicator	Operational Definition	Source
	Lightning	Installation of electric lights only in low-intensity parts and using LED (Light Emitting Diode) lights. Bright LED lighting not only can save energy up to 85% compared to traditional light bulbs but also environmentally friendly with bright white natural light that is comfortable for the eyes. The LED light has a bright light that can last up to 15 years of use.	[13] [15]
Water Efficiency	Irrigation	The efficiency of water use in the landscape aims to minimize the use of clean water from the land and the PDAM for the needs of landscape irrigation and replace it with other sources. By means of all water used for building irrigation does not come from groundwater sources or PDAMs, other than that by applying innovative technology for irrigation that can control the water requirements for the landscape that is appropriate to the needs of the plants.	[14] [8] [16]
	Grey Water	Rainwater by utilizing rainwater in innovative ways to accommodate and treat rainwater for domestic purposes, efforts to recycle water can be used to water the garden or as a rinse for the toilet.	[14] [8] [16]
Material Selection	Recycled Material	Building materials are the main basis for maximizing the use of renewable resources and reusing materials that are still used as a way to reduce waste.	[14] [8] [16]
	Salvaged Material	Utilizing waste material to be used also in construction so as not to dispose of old component materials that are still being used, utilizing used materials for buildings, old components that can still be used	[14] [8]

TABLES II. SUCCESS PROJECT VARIABLES AND OPERATIONAL DEFINITIONS

Variable	Indicator	Operational Definition	Source
Product Success	Customer Satisfaction	Customer Satisfaction is the 'happiness' level of people affected by a project. If the customer at the end of the project is satisfied, then the project can be considered successful in the long run.	[7] [17]
	Specific technic	Technical Requirements where in designing / building a project, technical requirements are important in the success of the project.	[7] [18]

Variable	Indicator	Operational Definition	Source
		As in the project scope / technical specifications that should be clearly explained before the project is carried out during the construction phase and during construction.	
	Functionality	The function definition is this criterion correlates with the expectations of the project participants and is best measured by the level of compliance with all specifications of technical performance. The financial and technical aspects applied to technical specifications must be considered, to achieve the goal of 'conformity for purpose'.	[7] [18]
Market Success	Competitive Advantage	Company positional advantages expressed by performance results. By treating marketing competencies, innovation and production as important resources and expertise for the company or a source of competitive advantage for the company	[7] [18]
	Market Share	The general market share is the company's total sales which are expressed as a percentage of sales.	[7] [18]
	Profitability	The company's ability to earn profits in relation to sales, total assets and own capital.	[7] [18]

III. RESULTS

From the literature analysis of several researchers who examined the relationship between the green aspects of design and the success aspects of the project, a conceptual framework will be used in this study.

Based on the conceptual model, it can be explained the hypothesis of this study is that green design has an effect on project success. Based on the conceptual model, three hypotheses in this study can be explained :

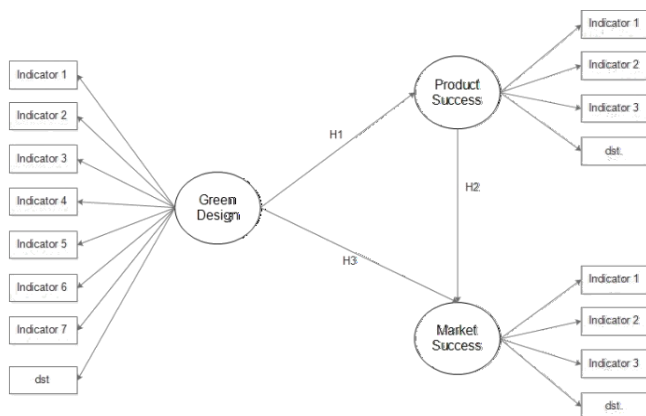

Fig. 1 Conceptual Model green design on project success

H1: The Green Design relationship has a direct effect on Product Success

H2: The relationship of Product Success has a direct effect on Market Success

H3: Green Design relationships have a direct effect on Market Success

IV. DISCUSSION

Relationship between Green Design and Market Success

In his study, it was explained that the increasing market demand for green buildings can be seen based on the BOMA Survey (Building Owners and Managers Association), for example, found that 61% of real estate leaders believe that green buildings can enhance their corporate image and 67% of these leaders believe that they will make the property of green features an important consideration. when choosing space (Kubba. 2017).

To achieve good green buildings, an integrated design team is needed. Kubba (2017) added that the design team, including designers, BIM managers, structural, mechanical, electrical, civil project events, to find the most effective way to meet the owner's goals and objectives. This is aided by a variety of different systems as units that integrate and recognize cumulative systems and components in the form of disciplines involved in their design.

Foster's research (1999) explains the business reasons for making this attractive green building market. Where operating costs and life cycles are lower and are generally recommended for green buildings. Many steps in green buildings can be treated as investments. Green building investment not only benefits buyers but also provides business opportunities for architects, developers, and almost all stakeholders in the building industry. The increase in the marketing of new green products can strengthen their market competitiveness. In the end, it changed the market as a pioneer.

Relationship between Green Design and Product Success

Other researchers stated in their research on the role of the community in the provision of public services, explaining that basically the role of the community here is expected to be able to contribute to the implementation of public services so that public services are appropriate and provide convenience for the community (Daryanto, 2014). With the participation of the public in organizing a public service, it is expected to have an effect on the success of a project, namely the desired customer needs accordingly.

Another study of Daryanto (2014) which examined customer satisfaction in the accessibility of shopping buildings explained that by fulfilling the satisfaction of accessibility, visitors to shopping centers could improve quality in an effort to provide satisfaction to visitors. Giving visitors satisfaction is expected to increase the value of the building, especially the value of accessibility which has an impact on increasing visitors and income in a shopping center. So that it can be concluded in his research that accessibility design criteria have been fulfilled, but from customer satisfaction surveys to accessibility, there are still things - things that they think need more attention from the

management of shopping centers, so that in improving quality services must also pay attention to user needs.

Relationship between Product Success and Market Success

Other researchers stated in their research on the role of the community in the provision of public services, explaining that basically the role of the community here is expected to be able to contribute to the implementation of public services so that public services are appropriate and provide convenience for the community (Daryanto. 2014). With public participation in organizing public services, it is expected to have an impact on the success of a project, which is following customer needs.

Another study of Daryanto (2014) which examined customer satisfaction in the accessibility of shopping buildings explained that by fulfilling the satisfaction of accessibility, visitors to shopping centers could improve quality in an effort to provide satisfaction to visitors. Giving visitors satisfaction is expected to increase the value of the building, especially the value of accessibility which has an impact on increasing visitors and income in a shopping center. So that it can be concluded in his research that accessibility design criteria have been fulfilled, but from customer satisfaction surveys to accessibility, there are still things - things that they think need more attention from the management of shopping centers, so that in improving quality services must also pay attention to user needs.

Based on data analysis with literature studies in previous studies, the present study has developed a conceptual framework 'Green Design and Success Project Conceptual Model', established relationship. From the results of the literature review analysis, it will be concluded from the perspective of the developer that Green Apartment design can directly affect long-term success or green apartment design can affect the long-term success indirectly through product success first.

Further research can be done by specifying indicators specifically in high rise buildings, especially apartment buildings so that they can provide very influential indicators of the green design concept and the success of medium and long term projects. Besides, that it can also be seen from a different perspective because the success of the project in the apartment has different perceptions on all stakeholders. And can continue the analysis with methods to obtain the expected hypothesis model.

ACKNOWLEDGMENT

This paper is a part of work of the thesis from the first author in the Civil Engineering of Master Program, Sepuluh Nopember Institute of Technology Surabaya, Indonesia. Acknowledgments are submitted for corresponding author from the second author in the Sepuluh Nopember Institute of Technology Surabaya, Indonesia.

REFERENCES

- Al-Tmeemy SM. HM, Abdul-Rahman H, Harun, Z., "Future Criteria for Success of Building Projects in Malaysia" *Int. J. Proj. Manage* 29: 337-348, 2011
- Blindenbach-Driessen, F. *Innovation management in project-based firms*. Doctoral thesis, School of Management. Rotterdam: Erasmus University. 2006.
- BREEAM UK., *New Construction Non Domestic Buildings* (BRE Global Ltd). 2014
- Chan APC., Scott D, Lam EWM. "Framework of Success Criteria for Design/Build Projects". *J. Manage. Eng*, 18, 120-128. 2002
- Cleland, D. I., & King, W. R. *Systems Analysis and Project Management*. New York: Mc Graw-Hill. 1987
- Daryanto., Ismanto Setyobudi. *Konsumen dan Pelayanan Prima*. Malang: Gaya Media. 2014
- Foster D.L. *The Marketing Communication Process*. Kogakusha: Mc. Grow Hull Inc.1999.
- Hair. J.F. Black. W.C. Barin. B.J. and Anderson R.E. *Multivariate Data Analysis a Global Perspective*. New Jersey: Pearson. 2010
- Kubba. *Handbook of Green Building Design and Construction* 111-161. 2017
- Lim CS, Mohamed MZ. *Criteria of Project Success: an Exploratory Re-examination* *Int. J. Proj. Manage* 17(4), 243-248. 1999
- Novriansyah. R. *Apa Itu Green Design* *Majalah Asri* (Indonesia), from majalahasri.com/apa-itu-green-design/. 2018
- Rachmayanti S and Roesli C. (2014). *Green Design Dalam Desain Interior Dan Arsitektur Humaniora*. vol 5 No. 2 : 930-939. 2014
- Shenhar, A. J., Dvir, D., Levy, O., Maltz, A. C. *Project Success: A Multidimensional Strategic Concept* *Long Range Planning Journal*, Vol. 34, 699-725. 2001.
- Singgih S. *SPSS 22 from Essential to Expert Skills*. Jakarta: Gramedia anggota IKAPI. 2014
- Turner, J., & Zolin, R. *Forecasting Success On Large Projects: Developing Reliable Scale to Predict Multiple Perspectives by Multiple Stakeholders Over Multiple Time Frames*. *Project Management Journal*, 87-99.2012.
- Wai SH., Yusof AMd, Ismail S. *Exploring Success Criteria from the Developers' Perspective in Malaysia* *Int. J. Eng. Bus. Manag* Vol. 4, 33. 2012

Future Transport System with Technology and its Chance for Indonesia : A Review

1st Muchammad Zaenal Muttaqin
Program Studi Teknik Sipil
Universitas Gadjah Mada/Universitas
Islam Riau
Yogyakarta/Pekanbaru, Indonesia
muchzaenalmuttaqin@eng.uir.ac.id

2nd Ahmad Munawar
Program Studi Teknik Sipil
Universitas Gadjah Mada
Yogyakarta, Indonesia

3rd Danang Parikesit
Program Studi Teknik Sipil
Universitas Gadjah Mada
Yogyakarta, Indonesia
dparikesit@gmail.com

Abstract— *Transport sector was becoming an important role for general nation development, including Indonesia. One of the increasing transport activity was due to technology used by people, like smartphone, online shop, etc., In this paper, we present an overview of transport development by time based on a comprehensive literature and practical report in the real world. This paper also discussed how the chance for Indonesia to overcome transport demand to reach sustainability. Based on this review, transport development from past, current and future was built by smart mobility concept through technology. Many alternative concept related with technology has been implemented as the solution for transport problem in the present and also predicting the future, like organizing about transport plan by GPS, monitoring transport activity by CCTV, using Artificial Intelligent (AI) system to improve comfortability, and safety in the public service and reach more regarding alternative energy source for future transport based from environmental friendly sources. Indonesia has a big chance to adopt them but also considering the existing condition in Indonesia, like heterogeneous cultural and economic reason. Implementation about future transport system supported by transport policies was becoming primary key to reach sustainability in Indonesia.*

Keywords— *Sustainability; Future Transport; Technology; Indonesia; Adaptation*

I. INTRODUCTION

This Transportation was one of the oldest activity in the world. It started since humans began entering the nomadic period when human lives in traditional way, like farming and hunting activity. A place with higher resource would be a transport hub as invasion destination when existing place has no resource again (Floerl & Inglis, 2005). Transport development was very slow in progress at the early time. Transportation was focused on providing routes based on the society needs especially to reach their lives by transport activity (FM Collins, Adams., Grant, & Humphreys, 2017). Next transport development happened especially during the first industrial revolution in 19th century. Transportation makes more significantly developed by machine to make better lives. Innovations, like developments in wagon and carriage design in the transport modes, changes in the technique of road building makes change in the society. Economic evaluation showed the effects of transport innovations in this era, reduced more than 40% in price for freight activity, 7.5% reduction in passenger fares, and a 60% reduction in passenger travel times then before (Bogart, 2005). Transport has been in growth and addressed some problem in transportation with scenario improvement. Issues as the result of transport development in this era was concerned with environmental friendly and

sustainability (Timms, Tight, & Watling, 2014). Thus, transport development would be continued along with innovation to solve transport problem especially because of transport demand and make better lives in the future.

In this paper we present a historical overview of the evolution of different transport development based on time. Time means development that happened from the past, current, and prediction in the future. The discussion is carried out how transportation develop for human society in the world and what primary key for transport development in the future. In detail, transport development has been carried out by many countries as a new transformation using technology-based innovations, including in Indonesia. Our main concern in this paper was exploring about transport development in the current days and its objective to solve transport problem and future prediction. In particular, the absence of machinery and technology, also Information system that happened today in the world, was highly affected by modification and innovation. In addition, this development would make a chance for becoming a benchmark for Indonesia which focused in the infrastructure which connect a place to another place in the society. Indonesia could adopt some strategy from other innovation and implement it in the society. Therefore, the main objective of the paper is to identify and do more exploration about transportation in the past, current, and what prediction for the future and also the chance for Indonesia adopting the system.

The methodological approach used to accomplish this objective rests on: (i) the presentation of a set of different transport development; in the world providing, whenever possible, information about GPS and Information technology; (ii) the condition about Indonesia's transport in the current days and prediction for the future from transport development in the world evolution of the structure of public transport markets relating to each urban transport mode and ; (iii) what supporting and hindering that implementation transport system in Indonesia, including involvement of public authorities in the provision of transport services.follow.

II. THEORY AND LITERATURE

A. Transport History in Industrial Revolution

Finding transport modes, road and other supporting tools of transportation made for human transport transformation. Transport infrastructure in London that connects regions started from 19th century triggered growth significantly in human mobility (Barker & Robbins, 2007). Industrial revolution made transport vehicle based from machine started to grow. Traveling by animal has been changed with car, bus,

truck or tram that based from machinery. Thus, modal split of transport has been created by distance, like horse-drawn wagons, electric train on the street, streetcars (trams), or bus, for short-distance travel, then cars and trains for long distance travel (Meyer, 2014). Cars system in industrial revolution claimed to make revolutionary for mobility assessment. Over the last century, the mechanization of transport makes people had more choice for their modes. People would assess more about which modes that has highest reduction in mobility costs before they choose them. Cities would be helped to make better lives in the city, in specific, related with connectivity and accessibility (Laconte, 2005). This impact still exist with following modes of streetcars, metro and regional rail systems, but has reached an entire difference with the spreading of privately owned cars (Gayda et al., 2005). In particular, Munawar (Munawar, 2007) stated private vehicle make some transport problem in the city, like congestion because disproportion between transport demand and infrastructure which means capacity is less than volume for today. Transit system that was first built accidentally in industrial revolution actually allowed for horizontal expansion, facilitated and required compact city, dense urban development and continued to produce human-scale urban environments although it is still not enough with the development of cars (Balcombe et al., 2004). Private vehicle is not only facilitated suburban developments at far lower density levels, but for the first time introduced a transport mode that also required significantly more space (per person) to operate than any previous one. (Muttaqin, 2017).

B. Role of Technology and Information System

Technology was starting to begin with the next era after industrial revolution and make some keys to develop transportation system after some problem and issue developed too. As Scranton (1995) stated in Costa and Fernandes (2012) stated too, technology devolved by periods to multiply its concepts, methods, and theories, to make new knowledge to receive wisdom. Technology would be a primary key in the limited thing because it made a new knowledge based on improvement from the past. In fact, much of the literature on history of technology confronts us with competing narratives regarding the nature of technological change.

Technology changed as an evolutionary with changes driven by 'Darwin-like' processes, such as "mutation, selection, adaptation, life-cycle, or survival". In this case, technology took a change through periods and develop its continuity or discontinuity, for instance recorder from CD-drive and now people shifted into an USB, so that CD-drive would be discontinued in the future. This thing was named as technology revolutions (Devezas, 2005). Besides, technology also has diffusion process as implementation of creative technology and named as innovation. Diffusion process in technology could be viewed as a process of cumulative result from individual or group calculations that weigh the incremental benefits from adopting new technology against the costs of change, often in an environment characterized by uncertainty and limited information (Hall, 2009). Diffusion of technology considers some factors to value rate of adoption for technology, including market structure, general regulatory and institutional environment. In particular with regulatory environment, technology diffusion was important for traditionally regulated industries such as those of transport and public utilities which gave that government action and

regulation. Both of them usually advance the diffusion of innovations which is under normal situations would not occur (Koellinger, 2006).

C. Future Theory Development

Technology Transport activity was always improved in quantities by time. It was not possible to predict what happened in future transport. Technology made prediction for the future easier with more scientific calculation than fortune-telling (Anderson, 2010). Future with scientific approach was dependent on what physical knowledge that could be tested and confirmed than prediction method by fortune telling. Future prediction in transportation could be built by specific approach based on time exploration, it is named as forecasting approaches.

Forecasting approach is well established and many researchers use this method as their prediction (Timms et al., 2014). This was like conventional forecasting, but took more investigation for both probable futures and possible futures. This method was excellent, especially for some reason to enable current trends that will continue into the future time. This method was enough for short period, like 10 years prediction. Most studies which used this method, did more input from public current trend to evaluate it for the prediction (Banister & Hickman, 2013). Thus, this method were fairly considered with a focus on the short term and small scale. In transport sector, forecasting assumed a process by which a prediction is made as to how the present transport system evolves into a future transport system. This scheme would be highly effective if there is clearly a certainty in the changing system (if there will be change) or current trends could be granted for some next year. Besides, transportation was also affected by human behavior (Ma, Liu, Wen, Wang, & Wu, 2017). Human behavior became specific barrier for this method. Generally, there were some factors that are identified to explain predictive inaccuracies by forecasting, among others,

- There were time limit to use forecasting method for precision between future and the current time. For instance, transport mobility related with behavior might occurred differently because behavior changed. Forecasting was limited when predicting new mobility behavior that occur in the future (Curtis, Scheurer, & Burke, 2010). Such a defect would be a chaotic effect if people enjoy its changing future which is different from the current time (Anable, Brand, Tran, & Eyre, 2012).
- Forecasting only represented future characteristic only for organization, like government authorities or transport suppliers as stakeholder who will response this condition in the future (Mula, Peidro, Díaz-Madroñero, & Vicens, 2010).
- Exogenous factor that affects the transport, for instance economic growth or population growth, typically treated before as base data, would change from some other forecasting source (Timms et al., 2014).

Implementation for future concept has recorded adoption by UK Government through UK Foresight Project in 2006. Transport future developed with exploring infrastructure in the current days and combined with technology to make effective process and enhance its use for the future. Technological opportunities were combined with social factors to make

strategies to respond future condition until 2055. The theory concept for the transport planning among others (Curry et al (2006) in Banister (2013)),

- Key policy areas and contextual drivers developed by the research;
- Uncertainty become level of exploration for possible futures;
- Environmental impact of transport systems and acceptability of intelligent infrastructure become main focus for transport plan;
- Climate change was seen as central issue to consider the program;
- Intelligent System implemented for infrastructure, and delivery of information;
- Each of strategies built in three horizons, firstly between 2005–2025 periods which based on existing technologies to invest in, develop and deploy the program; secondly from 2025–2040, based on known potential technologies for research, demonstration and possible market disruption; and from 2040–2055, which started to envision, explore and embody the program.
- Such scenario built by forecasting were presented to and commented on by a series of different groups to know what feedback the process from society is for the program. As

III. METHODOLOGY

This research used secondary data especially from resource data about transportation history that happened in the world and implementation for some country that can be a benchmark for transportation development for the current and future time. Context of the article for transport planning and a key concept is that of the transport scenario, which is defined in the present paper as a ‘snapshot of a future state of transport’ and response from transport development.

The research used forecasting as its method. These are most similar to conventional forecasting, but take a longer term perspective of the future that investigates both probable futures and possible futures. They are most useful for situations where substantial external change is not expected and where there is some expectation that current trends will continue into the future. The central actors have limited powers, the actions of many players need to be considered and there are many competing and vocal interest groups (Hayashi & Nakamura, 2013).

This research has objective of giving chance or option in Indonesia on how to develop transportation system in the future. Indonesia is a big country in the world and had problems in transportation like other countries, like congestion, pollutant, and others (Munawar, 2011). Besides, such phenomenon would develop if there are no response and transportation development. This research tried to review and explore by forecasting with literature and world facts for transportation improvement to give chance for Indonesian stakeholder to solve transportation problem in the current and future.

IV. RESULT AND ANALYSIS

A. Transportation Development Concept in the Past, Current, and Future

Global urban transportation trends further seem to suggest a development cycle whereby cities are affected by the same transformation, related more than anything else to their levels of wealth: initially rising living standards lead to the mechanization of transportation, first facilitated by public transport and then by private vehicles, while higher-income cities are rediscovering walking, cycling and public transport. For cities in emerging economies, the current phase is one of shifting from non-motorized to motorized transport modes, in a manner not unlike the transition of Western cities which was triggered by industrialization. Other related factors also hint at this analogous development: as travel speeds increase, so do travel distances; and the rate of territorial expansion of cities outstrips population growth, as discussed above. Global passenger transport has risen steeply over the 20th century; in the year 2000, total vehicular travel worldwide was estimated to be about 32 trillion passenger-km (tkm), up from only 2.8 tkm in 1950. Presently, most global passenger travel is by car, although air travel is increasing its share. Schafer and Victor in Moriarty and Honnery (2008) have projected global vehicular travel out to the year 2050. They consider travel to be constrained only by individual time expenditure and household budgetary outlays. They claim that, worldwide, travel time (including that for non-motorized travel) is roughly constant at about 1.1 h per person per day, and that at least for countries with levels of car ownership at 0.2 cars/capita and higher, households limit transport expenditures to around 10–15% of household income. With additional assumptions chiefly on future global income growth future travel levels and their split between high-speed (air and rapid rail) and other modes can be calculated. By 2050 they project a total of 103 km travel, with high speed modes and car travel accounting for close up to 80%. Although they see some bridging of the gap between high and low-travel countries, travel is also projected to grow strongly even in the already high-mobility OECD countries (Moriarty & Honnery, 2008).

The forecasted increase in the world’s population and its industrialization are the main drivers for the prediction. Rise in transportation demand, posing environmental concerns but also possible energy supply risks for the future. Traffic’s share in total demand for primary energy in the year 2004 amounted to 30.7% in Europe and to 38.9% in 2003 in North America (USA and Canada). Road transportation consumes the highest portion: 82.5% in Europe, and 82.3% in North America. (Ahrens et al., 2009). Thus, sustainability transportation with technology would be helping future transport system.

B. Technology impact

Headings, Information system and technology has been built and significantly improved. This improvement makes transportation changed too. In particular, Larasati (2018) stated that Indonesian people almost had a phone or more and some of them are smartphones in 2006. This development gave more impact to develop transport demand. The changing technology could hopefully be improved. However, another approach is to develop and combine other measures including traffic regulation, parking policy and public transport subsidy, which would be only second-best in a hypothetical situation where

road pricing is without costs. Some technologies that gave more impact in transportation among others,

- GPS (Global Positioning System)

GPS is a satellite navigation system used to determine the ground position of an object. GPS technology was first used by the United States military in the 1960s and expanded into civilian use over the next few decades. Today, GPS receivers are included in many commercial products, such as automobiles, smartphones, exercise watches, and GIS devices. There are three segments for GPS system in the world, among others,

- The space segment: the GPS satellites
- The control system, operated by the U.S. military,
- The user segment, which includes both military and civilian users and their GPS equipment.

This technology has changed mobility for transportation especially to know about route, distances, time that could be calculated easily with length of line in GPS between locations for people in real time. On transportation sector, this technology could be used for travel time calculation knowing place, and prediction about condition for the traffic based on using GPS system combined by information system (de Jong & Bliemer, 2015). GPS worked by sensor that installed in device and gave response from satellite and distance for both of them used to know accurate positioning in a part of world. All position could be detected by GPS if user was in the region that not in barrier of the sensor, like wall, high building, and others.

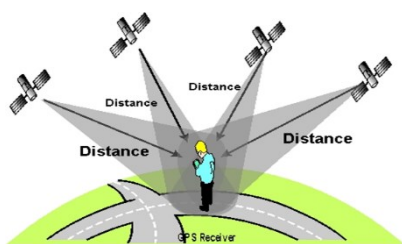

Fig. 6. Using GPS in real time (Argawal, 2017)

- Autonomous Vehicle System

Autonomous Vehicle System (AVs) is defined as system of vehicles where at least some aspects of a safety critical control function (e.g., steering, throttle, or braking) occur automatically without driver existing in the vehicle. AVs used sensors, cameras, light detection and ranging (LIDAR), global positioning systems (GPS), and other on-board technology to operate with reduced, limited and/or no human interaction (Berrada & Leurent, 2017). AVs can be passenger or public transport, and freight vehicles. AVs are not necessarily autonomous. Autonomous vehicles are responsible for driving, solely and independently, of other systems (Zmud & Sener, 2017).

- E-Commerce

E-Commerce was advance development from conventional market that happened before since human do interaction with others. E-Commerce arises due to the limited time and place which is still an obstacle to conventional trader. In particularly in Indonesia, development of e-commerce applies five basic

principles that made easier for it to develop, among others (Junaidi, 2016),

- All of the Indonesian citizens should be given an opportunity to access and conduct e-commerce transactions;
- All of the Indonesian citizens should be equipped with the skills and capabilities to take advantages from the economic formation;
- The Termination of Employment (PHK) should be minimized during the process of transition to the Internet-based economy, and the additional job opportunities have to be clean and positive after deducting the impact of creative destruction;
- A clear legal framework should be applied to ensure the E-Commerce industry is safe and open, including technology neutrality, transparency, and international consistency;
- The national players (industries), especially startups and SMEs (Small and Medium Enterprises) should be protected.

Hence, development of e-commerce has led to change in the movement for transportation, current and future time.

C. Future Transport Development by Technology

Transportation had many development actually because of technology. This article would be to explain more about part of transportation that is affected by technology, although it was not all developed sector built just only with them. Some parts of transportation that is affected among others,

- Transport technology for modes

Technology of transportation could be driven through future concept. Many technologies that has been discussed above is affected more in transportation. Table 1 below explained more about history condition without and with technology development in transportation sector,

TABLE I. PAST, CURRENT, AND FUTURE IN TRANSPORT BY TECHNOLOGY

No	Transport Technology	Past	Current	Future
1	GPS	People just used GPS for the location and did not analyze for something like route information.	GPS began to emerge and develop for people's life, like GPS for car tracking, weather information, but it is still in optional, such as in smartphones, and weather features. (Tambunan, 2009)	GPS is developed one of the benchmarks when driving and planning trips. Weather conditions will be necessary especially for mobility monitoring processes, such as travel guide. In public transport in future, GPS would be used as primary information to plan, act, and evaluation. (Tu et al., 2018)

2	Autonomous Vehicle (AVs)	There is no technology to develop this technology. Transport Development still focused on machinery as product of industrial revolution. (Eucar, 2016)	AVs has started to go on public as upgrading system to conventional personal vehicles with the essential characteristics of demand responsiveness, fleet repositioning, and share-ability. (Shen, Zhang, & Zhao, 2018).	AVs would significantly developed, through private or public transport. Higher mobility and easy to use become some consideration to develop AVs, like Autonomous pods that still in trial process in Dubai. (Fahmy, 2019).
3	Sensory Vehicle	There is no sensor in vehicle to help especially for security and control. All of them were still full by the driver itself. (Cacciabue, 2007)	Implementation for sensor vehicle has started. In current time, sensor become a tools to increase security, and comfortability, like for parking system and prevention before accident. (Jeong, Oh, & Lee, 2015)	Sensory vehicle is used to supporting autonomous vehicle as primary parts or baseline for autonomous vehicle system. All transport would be automatic in the future. (Puig-Pey, Bolea, Grau, & Casanovas, 2017)
4	Smart Information System	There is no technology or tools to do smart information, like ticketing system by manual in public transport. (Snellen & De Hollander, 2017)		
5	Source of Energy for Transportation	Fossil energy fuels became primary key for all transport tools, in details for vehicle. Alternative energy still less to reach for sustainability system, especially for vehicle (Fridstrøm, 2017).	Many alternative energy that found to do conversion from fossil fuel to more sustainable energy, like natural gas, biofuels, also electrical.	More sustainable energy and renew energy that could be alternative energy and implemented to transport vehicle, like hydrogen (Oman, 2002) and solar fuel (Oldenbroek, Verhoef, & van Wijk, 2017).

implementation of technology. It will open up great opportunities for Indonesia, which until now is still struggling with classic transportation problems, such as congestion, the number of transportation requests that are not balanced with transportation offers, to environmental issues which often become issues global occurrence in all countries. Technology sector became a primary key because industrial revolution 4.0 made technology improvement very high and Indonesia do not want to be outdated with them. A chance for Indonesia to be seen with public transport development and changing policy that suit with predicted mobility in the future. Changing mobility could be seen in table 2 below,

TABLE II. CHANGING MOBILITY IN THE FUTURE (Brad Templeton, 2012)

Current Time	Future time
Human driven	Computer driven
Scheduled	On-demand
Route-based	Ad-hoc
Large vehicles	Small and medium vehicles
Stop to stop	Door to door
People move to be near transit	Transit moves to be near people
Mostly public monopoly	Mix of public and private
Poor energy efficiency (in USA)	More sustainable
Needs expensive private right-of way to compete	Use existing ROW and metered roads
Takes people out of their way	Travel shortest or fastest route
Involves line transfers with long waits	30 second transfers
Often no seat	Reserved seating
Moderate unsubsidized cost	Low cost (low to no subsidy needed.)
Mostly "3rd class"	For all income levels, from economy to luxury

Human mobility as an object of the mobility must be regulated and given many alternatives so that people can re-changing about their plan about traveling activity. Some of the implementation that can be built in Indonesia among others,

- Policy and Regulation

Policy about transportation in Indonesia could be seen from regulation development that happened in past and current to predict what the important policy for the future. In past time, Indonesia has policy to build some infrastructures, like road, and railway as advanced program from Netherland when colonized before independence happened. In that time, Indonesia has centralized system, which all of policy and regulation was based from central government. Local Government had no power to intervene in the policy.

In the current time, there are local autonomy through UU No.23 Year 2004 which stated local region could make special policy only for the region. The role of regional autonomy is very influential on decisions related to transportation planning though government intervention is still dominant. For public transportation regulated through the regional government, there is no authority related to this matter. For instance, the development of BRT in Indonesia that is not uniform due to the autonomy process carried out by each region, such as Jakarta (TransJakarta), Bogor (TransPakuan), Yogyakarta (TransJogja), Bandung (Trans Metro Bandung), Palembang (Trans Musi), Semarang (TransSemarang), Pekanbaru (Trans Metro Pekanbaru), Solo (Trans Solo Batik), Trans Sarbagita

D. Chance of Future Transport System in Indonesia

Indonesia, as a big country in the world has chance to adopt future transportation in the world with local condition in Indonesia. Innovation in Indonesia was mainly related to the

(Denpasar), Padang (Trans Padang), and Makassar (Trans Mamminasata Busway).

Future time for policy in Indonesia could be with public transport authority. The role of the authority will be a determinant of controlling the transportation system. Besides, coordination between institutions is still a major point in the development of future transport in Indonesia. Besides, ineffective legal and administrative structures from government especially for public transport must be solved for better public transport system in Indonesia (Munawar, 2008). In particular, government has future duties especially for transportation among others,

- a) Defining future transportation planning.
 - b) Determination of roles is needed for the achievement of planning of the transportation system.
 - c) Evaluating capabilities and identify weak points.
 - d) Implementing with a consumer approach and data centric.
- Smart Card or Digital Wallet

Smart Card was a smart system implementation which is filled with controlling the payment use in public transport. In the past, this system was not yet used. People must pay the service according to the selection of services that can be used (usually through a counter located in a certain location). In the current time, there were many variant of Smart Card that can be used for payment. And so, it still requires more completion, especially for the function of the card itself. For the future, Smart Cards could become a key role in backend services that exist and even the increase on wireless tickets, such as smartphone applications and digital wallets that would be a determinant of transport services.

CONCLUSION AND RECOMMENDATION

The Based on texts above, we can conclude some conclusions, among others,

- Transportation is always developing in accordance with the dynamics of human development itself.
- Technology is very influential on the development of the world of transportation.
- In the past, transportation was still managed manually and completely controlled by humans.
- Technology is very influential in the development of transportation for the future.
- In the future, autonomous technology, and simplification of mobility needs will be a major requirement in future transportation developments.
- Indonesia as a developing country will be predicted to be able to adapt to the development of transportation in the future. Future transportation predictions that are now global in nature must be able to be responded by stakeholders so that transportation problems do not grow.

This research discussed more about transport future system that would happen in the future and what Indonesia would take as benchmark and implement for its country. Based from

results, authors just explored about new technologies and its impact for transport development and also research just took samples from developed country as front pioneer for this development. Future research could be done with exploring the condition in Indonesia, through regulation policy, society condition and socio economic with direct survey to know first about characteristic of transportation in Indonesia. Analysis SWOT (Strength, Weakness, Opportunity, and Threat) could be used to analyze it. Later, forecasting system in the future can be reached by visioning method and exploratory method as comparison thing for further research.

REFERENCES

- Agarwal, T. (2017). How GPS System Works ? Retrieved February 14, 2019, from <https://www.elprocus.com/how-gps-system-works/>
- Ahrens, G., Dellmann, T., Gies, S., Hecht, M., Hefazi, H., Henke, R., ... Tegel, O. (2009). Transport System. In K.-H. Grote & Erik K. Antonsson (Eds.), *Springer Handbook of Mechanical Engineering*, Volume 10 (pp. 1011–1147). Heidelberg: Springer-Verlag Berlin Heidelberg. Retrieved from <https://books.google.co.id/books?id=9T5kd-ewRE8C&lpq=PA1011&ots=5hP3zFxnTB&dq=Transportation is derived from two Latin words trans and porta meaning in between and carry- ing%2C respectively. Transportation is seen as one of the basic human needs and has>
- Anable, J., Brand, C., Tran, M., & Eyre, N. (2012). Modelling transport energy demand: A socio-technical approach. *Energy Policy*, 41, 125–138. <http://doi.org/10.1016/j.enpol.2010.08.020>
- Anderson, B. (2010). Preemption, precaution, preparedness: Anticipatory action and future geographies. *Progress in Human Geography*, 34(6), 777–798. <http://doi.org/10.1177/0309132510362600>
- Balcombe, R., Mackett, R., Paulley, N., Preston, J., Shires, J., Titheridge, H., ... White, P. (2004). The demand for public transport: a practical guide. *Transport Policy* (Vol. 13). London.
- Banister, D., & Hickman, R. (2013). Transport futures: Thinking the unthinkable. *Transport Policy*, 29, 283–293. <http://doi.org/10.1016/j.tranpol.2012.07.005>
- Barker, T., & Robbins, M. (2007). *A HISTORY OF LONDON TRANSPORT*.
- Berrada, J., & Leurent, F. (2017). Modeling Transportation Systems involving Autonomous Vehicles: A State of the Art. In *Transportation Research Procedia* (Vol. 27, pp. 215–221). Elsevier B.V. <http://doi.org/10.1016/j.trpro.2017.12.077>
- Bogart, D. (2005). Turnpike trusts and the transportation revolution in 18th century England. *Explorations in Economic History*, 42(4), 479–508. <http://doi.org/10.1016/j.eeh.2005.02.001>
- Brad Templeton. (2012). The Future of Mass Public Transport, pp. 1–9. Retrieved from <https://www.templetons.com/brad/robocars/future-transit.html>
- Cacciabue, C. (2007). *Modelling Driver Behaviour in Automotive Environments*. London: Springer International Publishing.
- Costa, Á., & Fernandes, R. (2012). Urban public transport in Europe: Technology diffusion and market organisation. *Transportation Research Part A: Policy and Practice*, 46(2), 269–284. <http://doi.org/10.1016/j.tra.2011.09.002>
- Curry, A., Hodgson, T., Rachel Kelnar, & Wilson, A. (2006). *Intelligent Infrastructure The Scenarios – Towards 2055*. Victoria. London. Retrieved from http://www.foresight.gov.uk/Intelligent_Infrastructure_Systems/Reports_and_Publications/Intelligent_In_frastructure_Futures/the_scenarios_2055.pdf
- Curtis, C., Scheurer, J. A. N., & Burke, M. (2010). The dead end of demand modelling : supplying a futures-based public transport plan. In *Proceedings of the 24th Association of European Schools of Planning (AESOP) Annual Conference* (pp. 7–10). Griffith University. Retrieved from <http://hdl.handle.net/10072/36733>
- de Jong, G. C., & Bliemer, M. C. J. (2015). On including travel time reliability of road traffic in appraisal. *Transportation Research*

- Part A: Policy and Practice, 73, 80–95. <http://doi.org/10.1016/j.tra.2015.01.006>
- Devezas, T. C. (2005). Evolutionary theory of technological change: State-of-the-art and new approaches. *Technological Forecasting and Social Change*, 72(9), 1137–1152. <http://doi.org/10.1016/j.techfore.2004.10.006>
- Eucar. (2016). Key Challenges for Future Mobility and Transport Key Challenges for Future Mobility and Transport. Retrieved from http://www.eucar.be/wp-content/uploads/2016/08/Key-Challenges-for-Future-Mobility-and-Transport_final.pdf
- Fahmy, T. (2019). Dubai tests autonomous pods in drive for smart city. Retrieved February 15, 2019, from <https://www.reuters.com/article/us-emirates-transportation-autonomous/dubai-tests-autonomous-pods-in-drive-for-smart-city-idUSKCN1GD5G6>
- Floerl, O., & Inglis, G. J. (2005). Starting the invasion pathway: The interaction between source populations and human transport vectors. *Biological Invasions*, 7(4), 589–606. <http://doi.org/10.1007/s10530-004-0952-8>
- FM Collins, Adams., S., Grant, R., & Humphreys, A. (2017). *Journey: An Illustrated History of Travel*. New York: PENGUIN. Retrieved from https://books.google.co.id/books?hl=id&lr=&id=OIQ1DwAAQBAJ&oi=fnd&pg=PA4&dq=transportation+history%22&ots=Fj-pRixI0R&sig=W97oY51dxXQOMtxybauTdjv3vM&redir_esc=y#v=onepage&q=transportation+history%22&f=false
- Fridström, L. (2017). From innovation to penetration: Calculating the energy transition time lag for motor vehicles. *Energy Policy*, 108(June), 487–502. <http://doi.org/10.1016/j.enpol.2017.06.026>
- Gayda, S., Haag, G., Besussi, E., Lautso, K., Noël, C., Martino, A., ... Dormois, R. (2005). *Sprawling Cities And Transport: from Evaluation to Recommendations*.
- Hall, B. H. (2009). *Innovation and Diffusion*. The Oxford Handbook of Innovation, (January). <http://doi.org/10.1093/oxfordhb/9780199286805.003.0017>
- Hayashi, Y., & Nakamura, K. (2013). Climate change, mobility and cost of transport. *Transport Policy*, 29, 261–263. <http://doi.org/10.1016/j.tranpol.2012.07.006>
- Jeong, E., Oh, C., & Lee, G. (2015). Emission evaluation of inter-vehicle safety warning information systems. *Transportation Research Part D: Transport and Environment*, 41, 106–117. <http://doi.org/10.1016/j.trd.2015.09.018>
- Junaidi. (2016). Trends and Problems of Information and Communications Technology (ICT) in Indonesia from the Perspective of Media Framing. *Jurnal Ilmu Komunikasi*, 14(2), 71–79.
- Koellinger, P. (2006). *Technological Change: An Analysis of the Diffusion and Implications of e-Business Technologies*. Development and Comp Systems 0507008, EconWPA. Humboldt-Universität. Retrieved from citeseerx.ist.psu.edu/viewdoc/download?doi=10.1.1.90.5228&rep=rep1&type=pdf
- Laconte, P. (2005). *Urban and Transport Management – International Trends and Practices*. In *Sustainable Urban Transport and City* (pp. 1–12). Shanghai. Retrieved from http://www.ffue.org/wp-content/uploads/2012/07/Laconte_Urban_and_transpMgt_Shanghai_2005.pdf
- Larasati, D., & Kasri, R. A. (2018). Demand of Using Sharing-Based Transportation Services in Indonesia: Does Socio-Religious Preference Matter? *Advances in Social Science, Education and Humanities Research (ASSEHR)*, Volume 126 2nd International Conference on Indonesian Economy and Development (ICIED 2017), 126(Icied 2017), 148–152. Retrieved from <https://download.atlantis-press.com/article/25892323.pdf>
- Ma, X., Liu, C., Wen, H., Wang, Y., & Wu, Y. J. (2017). Understanding commuting patterns using transit smart card data. *Journal of Transport Geography*, 58, 135–145. <http://doi.org/10.1016/j.jtrangeo.2016.12.001>
- Meyer, G. (2014). *Megacity Mobility Culture*. (G. Meyer & S. Beiker, Eds.). Cham: Springer International Publishing. <http://doi.org/10.1007/978-3-319-05990-7>
- Moriarty, P., & Honnery, D. (2008). Low-mobility: The future of transport. *Futures*, 40(10), 865–872. <http://doi.org/10.1016/j.futures.2008.07.021>
- Mula, J., Peidro, D., Díaz-Madroñero, M., & Vicens, E. (2010). Mathematical programming models for supply chain production and transport planning. *European Journal of Operational Research*, 204(3), 377–390. <http://doi.org/10.1016/j.ejor.2009.09.008>
- Munawar, A. (2007). *Public Transport Reform in Indonesia , A Case Study in the City of Yogyakarta*. *Engineering and Technology*, 28, 39–44.
- Munawar, A. (2008). *Sustainable Urban Public Transport Planning in Indonesia , Case Studies in Yogyakarta and Jakarta*, (May), 13–15.
- Munawar, A. (2011). Speed and capacity for urban roads, Indonesian experience. *Procedia - Social and Behavioral Sciences*, 16, 382–387. <http://doi.org/10.1016/j.sbspro.2011.04.459>
- Muttaqin, M. Z. (2017). KARAKTERISTIK PEMILIHAN MODA SEPEDA MOTOR KELOMPOK MAHASISWA UNIVERSITAS ISLAM RIAU (Studi Kasus : Fakultas Teknik), 26–27.
- Oldenbroek, V., Verhoef, L. A., & van Wijk, A. J. M. (2017). Fuel cell electric vehicle as a power plant: Fully renewable integrated transport and energy system design and analysis for smart city areas. *International Journal of Hydrogen Energy*, 42(12), 8166–8196. <http://doi.org/10.1016/j.ijhydene.2017.01.155>
- Oman, H. (2002). Eventful developments in energy conversion. *IEEE Aerospace and Electronic Systems Magazine*, 17(1), 34–40. <http://doi.org/10.1109/62.978363>
- Puig-Pey, A., Bolea, Y., Grau, A., & Casanovas, J. (2017). Public entities driven robotic innovation in urban areas. *Robotics and Autonomous Systems*, 92, 162–172. <http://doi.org/10.1016/j.robot.2017.03.006>
- Shen, Y., Zhang, H., & Zhao, J. (2018). Integrating shared autonomous vehicle in public transportation system: A supply-side simulation of the first-mile service in Singapore. *Transportation Research Part A: Policy and Practice*, 113(June 2017), 125–136. <http://doi.org/10.1016/j.tra.2018.04.004>
- Snellen, D., & De Hollander, G. (2017). ICT'S change transport and mobility: Mind the policy gap! In *Transportation Research Procedia* (Vol. 26, pp. 3–12). Elsevier B.V. <http://doi.org/10.1016/j.trpro.2017.07.003>
- Tambunan, E. (2009). *VEHICLE TRACKING SYSTEM AKURASI TINGGI DALAM TRANSPORTASI LOGISTIK BERBASIS GSM - GPS - GIS*. In *FSTPT 12* (pp. 48–55). Surabaya: FSTPT.
- Timms, P., Tight, M., & Watling, D. (2014). *Imagineering mobility: Constructing utopias for future urban transport*. *Environment and Planning A*, 46(1), 78–93. <http://doi.org/10.1068/a45669>
- Tu, W., Cao, R., Yue, Y., Zhou, B., Li, Q., & Li, Q. (2018). Spatial variations in urban public ridership derived from GPS trajectories and smart card data. *Journal of Transport Geography*, 69(3688), 45–57. <http://doi.org/10.1016/j.jtrangeo.2018.04.013>
- Zmud, J. P., & Sener, I. N. (2017). *Towards an Understanding of the Travel Behavior Impact of Autonomous Vehicles*. *Transportation Research Procedia*, 25, 2504–2523. <http://doi.org/10.1016/j.trpro.2017.05.281>

Queues and Delays at Unsignalized Intersection, Indonesian Experience

Ratnasari Ramlan

Department of Civil and Environmental Engineering, Faculty of Engineering, Universitas Gadjah Mada
Yogyakarta, Indonesia
ramlanratnasari@gmail.com

Ahmad Munawar

Department of Civil and Environmental Engineering, Faculty of Engineering, Universitas Gadjah Mada
Yogyakarta, Indonesia
munawarugm@gmail.com

Muhammad Zudhy Irawan

Department of Civil and Environmental Engineering, Faculty of Engineering, Universitas Gadjah Mada
Yogyakarta, Indonesia
zudhyirawan@ugm.ac.id

Abstract—Queues and delays are important factors in determining the performance of unsignalized intersections. The method used in determining the queue and delay must be under the traffic conditions of each intersection. Differences in traffic characteristics in each country cause different methods of queuing and delay calculations. The calculation method that suits the traffic characteristics in Indonesia is the IHCM, but it is necessary to make some updates to the intersection adjustment factor. This study serves to assess the IHCM method in determining the value of queues and delays at unsignalized intersections with traffic data from 8 cities in Indonesia. The results showed that the delay based on IHCM had a higher value compared to the actual delay so that a revised PCE value for motorcycles was set at 0.1. The final result shows that after the revision, the predicted delay value is the same as the actual delay.

Keywords—Queue, Delay, IHCM, Unsignalized Intersection.

INTRODUCTION

Unsignalized intersection performance consists of capacity, delay, and queue. Calculation of intersection performance is essential in designing and operating a traffic control system. Research on the performance of unsignalized intersections is minimal compared to signalized intersections. Low traffic flow and small road size cause this intersection to get less attention. So that special handling is needed in designing the performance of intersections in order to form the right formula so that traffic at unsigned intersections becomes safe and smooth.

Queues and delays as a result of high traffic volume at unsignalized intersections have an impact on the smooth flow of intersections. As a result of the high delay and the long queue of vehicles cause the driver to become more aggressive (Liu et al. 2017) and to become impatient (Abhishek et al. 2016). On the other hand, the high number of pedestrians (Fitzpatrick et al. 2007) and the number of non-motorized vehicles (Xiu et al. 2016) contributed to the length of delays and the length of queues at intersections. As a result, the level of safety and security of intersections has decreased. To avoid these problems, handling policies by the traffic conditions is needed. Queues and delays must be calculated using appropriate methods so that the performance of the intersection remains stable.

There are several methods used in calculating queues and delays. First is the deterministic queuing model; This model is used at intersections with uniform and constant flow of vehicles, the number of vehicles coming in is balanced with the number of vehicles coming out. Second is the Steady-state stochastic model; this model is commonly known as the Webster model (Webster, 1958). Suitable for low saturation conditions, where this model randomly calculates vehicles that come using a Poisson distribution and headway between connected vehicles. Some researchers consider the steady-state stochastic model to have disadvantages because only at low capacity intersections (Fabra and Roupail, 1997). The third method is the Time-dependent model (Akcelik, 1980); This model is widely used because it is by traffic conditions that are adjusted to travel time. The HCM 2000 model and the Shanghai Adjusted model adopt this model in delay calculations.

Some researchers began to develop the three delay models because it does not match the traffic conditions in their country. Saha et al (2017) modified the Webster and HCM models in determining delays in India. The results show that modifying the model proves that the difference between predicted and field delays is less than 5%. Guller and Menendez (2017) also modified the delay calculation in Switzerland so that it can predict delays of up to 4 seconds/vehicle. In other countries, (Wang et al. 2015) states that the HCM and Shanghai adjusted models are the most appropriate applied in calculating delays in Shanghai compared to other methods.

Based on the information above, it can be concluded that the determination of the queue and delay value at unsignalized intersections is not constant. Depending on the traffic conditions in each country. Especially in developing countries, where heterogeneous traffic and a large number of motorcycles (Patil and Sangolle, 2016) so that driver habits will affect the calculation of queues and delays.

The method used in queuing and delay calculations in Indonesia is to use the Indonesian Highway Capacity Manual (IHCM) (Direktorat Jenderal Bina Marga, 1997). The IHCM becomes the main guideline in determining the performance of intersections. When the IHCM was applied more than 20 years ago, this guideline was considered the most appropriate traffic characteristic in Indonesia.

According to (Irawan et al. 2010), IHCM can provide more accurate results on traffic volumes in Indonesia compared to the US Bureau of Public Roads (BPR). However (Munawar, 2006) states that the IHCM is no longer suitable for calculating the performance of signalized intersections because of the high number of motorcycles so that improvements in the equivalent value of passenger cars for motorbikes. Other research conducted (Magfirona et al. 2015) states that the delay of the calculation result is higher than the field delay at the signal intersection due to an error in determining the intersection adjustment factors. The change in traffic conditions in Indonesia makes IHCM no longer suitable for calculating the performance of signalized intersections.

So far, more attention has been paid to the accuracy of the IHCM for calculating the performance of signalized intersections. However, the accuracy of IHCM over changes in traffic conditions in Indonesia so far has not been done to calculate the performance of unsigned intersections. Meanwhile, this intersection has many problems in the form of high accident rates due to a lack of traffic control and high queues and delays. Thus, this study was conducted to test the delay and queuing models at IHCM based on the traffic that occurred at unsignalized intersections. In order to obtain accurate results, traffic data collection from cities of small, medium and large sizes is carried out so that it can describe the traffic conditions in all cities in Indonesia. In this study, a revised value of Passenger Car Equivalent (PCE) for motorcycles was made to suit the traffic conditions in Indonesia which had 60% more motorcycles compared to other vehicles (BPS, 2018).

The results show that the IHCM method is not compatible with traffic conditions in Indonesia because the number of vehicles is increasing every year. By using the speed method, an evaluation of the PCE value for the motorcycle is carried out. Revisions to motorcycle PCE affect the calculation of traffic flow at intersections (Tan et al. 2018). It is expected that in the future, this research can contribute to related parties in the framework of updating existing parameters in IHCM so that they are by traffic conditions in Indonesia.

RESEARCH METHODOLOGY

The Indonesian Highway Capacity Manual (IHCM) was published in 1997. Figure 1 shows the flow chart for the calculation of unsignalized intersection performance using the IHCM method.

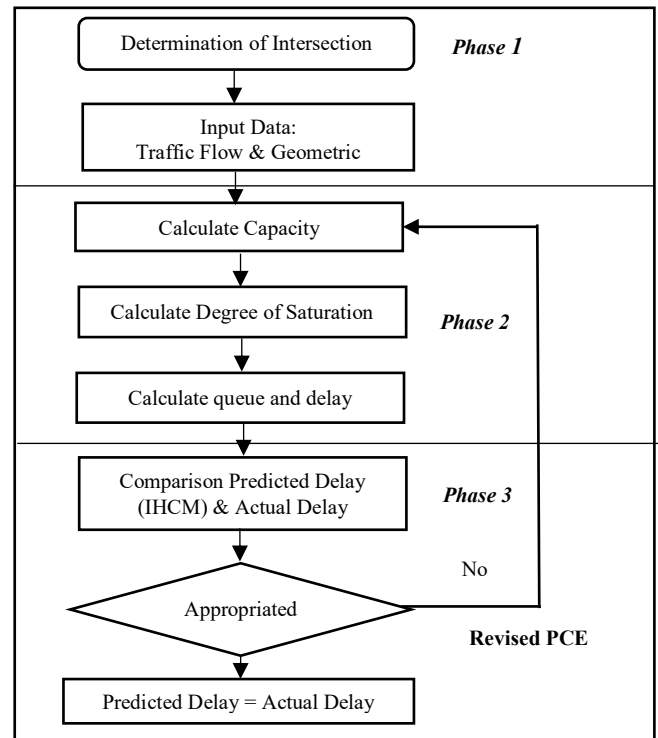

Fig. 1. Flowchart of the Research

This study was divided into 3 main phases as follows.

A. Phase 1. Determining the location of research and data collection intersection

1). *Determination of intersection location*: The research location is determined based on specific criteria, including; several vehicles, delays, queues, and high side barriers. In this study, eight unsignalized intersections consisted of cities in Indonesia (Table 1). The type of intersection is type 322 (3 arms, two lines on minor road and two lines on the major road). Data collection of traffic using a camera is placed at the height of ± 6 meters so that the movement of the vehicle at the intersection can be recorded. Traffic data records are carried out during crossing traffic peak hours. Figure 2 shows an example of video traffic movements that occur at unsignalized intersections in Cirebon city and Semarang city.



Fig. 2. Sample screen capture of video data on Cirebon city and Semarang city.

TABLE I. RESEARCH LOCATION

City	Intersection	Adjacent land use characteristics	Population (2018)
Cirebon	Siliwangi-Moh Toha	Commercial	334.690 ^a
Yogyakarta	Seturan Raya-Babarsari	Commercial	417.744 ^a
Tasikmalaya	Muh Hatta-Ahmad Yani	Commercial	808.506 ^b
Bandung	Martanegara-Maskumambang	Commercial	2.440.717 ^c
Makassar	Lanto dg. Pasewang-Rusa	Commercial & Residential	1.671.001 ^c
Medan	Sakti Lubis-STM	Commercial	2.499.838 ^c
Semarang	P. Diponegoro-L. Soeprapto	Commercial & office area	1.667.131 ^c
Sidoardjo	Raya Suko-Cemeng Kalang	Commercial	2.279.000 ^c

a = small city
 b = medium city
 c = large city

2). *Input Data*: The data obtained is the composition of traffic vehicles that are divided into motorcycles (MC), light vehicles (LV), and heavy vehicles (HV). In addition to traffic flow data, geometric data also includes data used in calculating the intersection performance of the unsignalized intersection. This geometric data includes; road width, many lanes, a width of the lane, and data on land use for environmental conditions.

B. Phase 2. Calculation Performance of Unsignalized Intersection using the IHCM method.

1). *Calculate Capacity*:

$$C = C_0 \times F_W \times F_M \times F_{CS} \times F_{RSU} \times F_{LT} \times F_{RT} \times F_{MI} \tag{1}$$

- C_0 = basic capacity
- F_W = adjustment factor of entry width
- F_M = adjustment factor of road median type
- F_{CS} = adjustment factor of road city size
- F_{RSU} = adjustment factor of road environment type, friction side, and unmotorized vehicle
- F_{LT} = adjustment factor of, adjustment factor of left turn
- F_{RT} = adjustment factor of right turn
- F_{MI} = adjustment factor of minor road flow.

2). *Calculate of Degree of saturation*:

$$DS = Q_{Tot}/C \tag{2}$$

- DS = degree of Saturation
- Q_{Tot} = traffic Volume (Q_{pcu})
- C = capacity

3). *Calculate Delay & Queue*:

$$D = D_G + D_{TI} \tag{3}$$

- D = intersection Delay (s/PCU)
- D_G = geometric Delay
- D_{TI} = traffic Delay

$$QP\% = 9.02 \times DS + 20.66 \times DS^2 + 10.49 \times DS^3 \tag{4}$$

- QP = queue of probability
- DS = degree of Saturation

C. Phase 3. Comparison of Predicted Delay and Actual Delay

The work steps in this phase are:

1. *Calculate the actual delay*, obtained by calculating the average time difference between vehicles passing through the intersection without interference with vehicles passing through the intersection there are disturbances. The calculation time starts at a distance of 10 m from the intersection conflict area.

2. *Comparing the results obtained between predicted delay (IHCM) and actual delay*. By using a comparison graph, if the data distribution does not show the same relative value between predicted delay and actual delay, then there must be a modification to the queue and delay intersection.

3. *Revision of the PCE value for motorcycles using the speed method* (Chandra and Kumar, 2003).

$$PCE_i = \frac{v_c/v_i}{A_c/A_i} \tag{5}$$

- PCE_i = equivalent of a passenger car for type i vehicles
- v_c = the average speed of a passenger car
- v_i = the average speed of a type i vehicle
- A_c = Dimensions of passenger car vehicles

A_i Vehicle dimensions of type i vehicles

The final result of this study was that there were no significant differences between the actual delay predicted and the delay.

RESULT

A. Phase 1. Determining the location of research and data collection intersection.

The location of the study has been determined, then the number of vehicles per hour is calculated according to Figure 3.

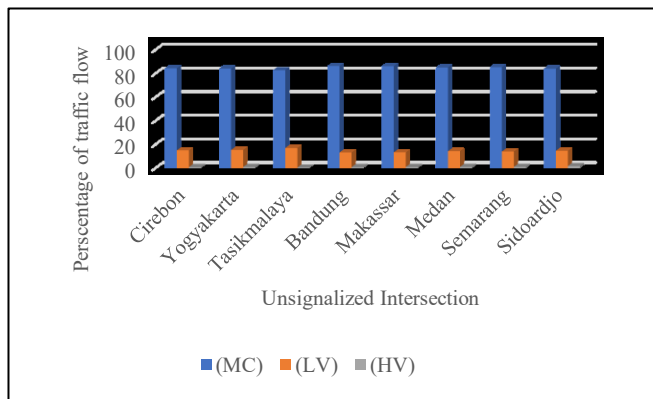

Based on Figure3, it appears that motorcycles dominate the composition of vehicles for all intersections. The percentage of motorcycles (MC) > 80% for all intersections shows that the majority of unsignalized intersections in Indonesia are traversed by motorcycles, besides the percentage of light vehicles ranging from 12-17% and heavy vehicles <1%.

B. Phase 2. Calculation Performance of Unsignalized Intersection using the IHCM method.

This phase calculates the performance of the intersection using equations (1-4). The initial step is to calculate the capacity of the intersection based on vehicle flow (PCU/h).

Figure 4 shows the comparison between the total current amount and the capacity value obtained by the IHCM method. The current value is the total traffic flow of all types of vehicles in junior high school/hour. The calculation results show that for all intersections, the amount of traffic flow ranges from 2500-3500 PCU/hour. The basic capacity value based on IHCM for unsignalized intersections with type 322 is 2700 so that it produces capacity values for eight cities ranging from 2500-4500. Besides, Figure 4 shows that the majority of intersections have a capacity value that is higher than the amount of current; this means that these intersections are still eligible to serve vehicle movements. However, it is different for Sidoarjo city. It is capacity value is smaller than the amount of vehicle flow, which will result in high queues and delay lengths that occur at the intersection.

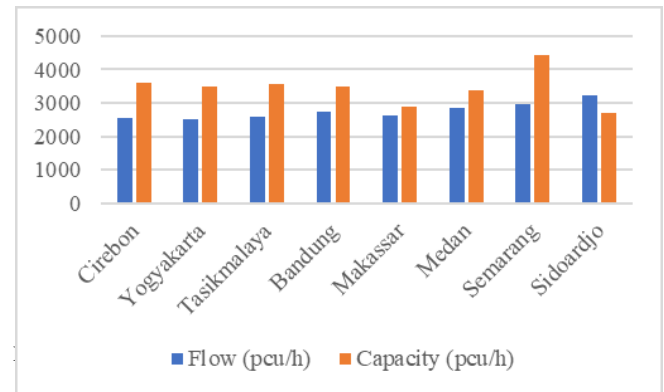

After obtaining the capacity value for each intersection, then the probability of queuing calculation is carried out, the results are shown in Table 2.

TABLE 2
QUEUES AND DELAYS OF PROBABILITY FOR UNSIGNALIZED INTERSECTION (IHCM METHOD)

Intersection	Delay (s/PCU)	A queue of Probability (QP)	
		Lower Limit (%)	Upper Limit (%)
Cirebon	11.95	20,18	40,93
Yogyakarta	12.19	21,15	42,70
Tasikmalaya	12.24	21,37	43,08
Bandung	13.19	24,92	49,63
Makassar	16.03	33,61	66,30
Medan	14.45	29,14	57,60
Semarang	11.48	18,22	37,43
Sidoarjo	35.88	56,81	115,08

Table 2 shows the results of queuing delay and probability calculations using the IHCM method. Intersections experience an average delay of 20 - 30 s/PCU. However, in Sidoarjo City reached a delay value of 36 s/PCU and a queue value, where the average queuing probability for the lower limit ranges from 20-30%, and the upper limit ranges from 40-60%. Only the intersection on the site of the city of Sidoarjo has the highest queuing probability, namely 56.81% - 115.08%, due to intersections in this region having high traffic density, especially in the composition of heavy vehicles.

C. Phase 3. Comparison of Predicted Delay and Actual Delay

Phase 2 of the delay value and prediction queue were calculated using the IHCM method. Next, to test the accuracy of the delay results and prediction queues, the delay calculation in the field is carried out, by observing the movement of vehicles that experience interference when entering the intersection. The average time difference of a vehicle that is not interrupted by a vehicle that is interrupted when entering an intersection is used as an actual delay. The calculation results show, even though the traffic is heavy, but overall the movement of vehicles at the unsigined intersection is relatively smooth.

The next step is to compare the results of the calculation of actual and prediction delays using a graph, where the distribution of data shows whether there is a difference between the actual and prediction delays. The results can be seen in Figure 5, which is the uneven distribution of data shows that the predicted delay value is greater than the actual delay. It is thought to be caused by a high percentage of the number of vehicles that affects the value of capacity, delays, and queues. Previously discussed about PCE, according to IHCM, the value of PCE for motorcycles at unsignalized intersections was 0.5. It means that motorcycles are considered equivalent to half the value of passenger cars. The reality on the ground shows that motorbikes are more clustered, so it is necessary to revise PCE values for motorcycles. The same thing was done by (Mohan and Chandra, 2016) by recalculating the PCE value of motorcycles in India and (Tan et al. 2018) testing the PCE value of motorbikes according to the traffic conditions in Vietnam.

the predicted delay and actual delay values has improved and spread regularly, which means the predicted delay value is the same as the actual delay.

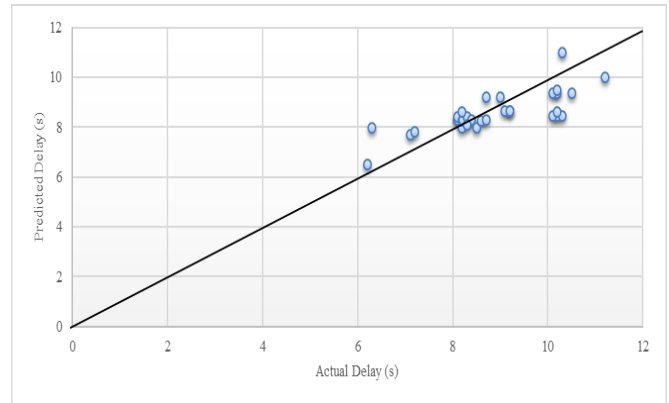

Fig. 6. A comparison between actual and predicted delay (revised PCE)

The final results of the research provide information that the IHCM method in calculating queues and delays at unsignalized intersections is still by the characteristics of traffic in Indonesia but needs to be improved on the PCE value of motorcycles.

IV. CONCLUSIONS

Based on research on queues and delays at unsignalized intersections in Indonesia, the conclusions that can be drawn are as follows:

- (1). The IHCM method can still be used because it is by the traffic characteristics in Indonesia.
- (2). Testing of the predicted delay value (IHCM) with the field delay indicates a difference in results, i.e., the predicted delay value is greater than the actual delay.
- (3). The difference in the value of the delay is thought to be due to the percentage of the number of motorcycles that dominates the entire motorized vehicle at unsignalized intersections
- (4). After a revised PCE value for the motorcycle, it turns out that it can reduce the predicted delay value so that it is equal to the actual delay.

This study is limited to delays that occur in the field by taking the average overall vehicle delay. Delay calculations need to be done for each type of vehicle to obtain more accurate results. Besides, the PCE calculation is only done based on the speed method and is expected to be able to use other methods such as the headway method and the density method. It is expected that in subsequent studies, the results of this study can be used as a reference in updating the IHCM to suit the current Indonesian traffic conditions, to determine the value of delays and unsigned intersection queues precisely.

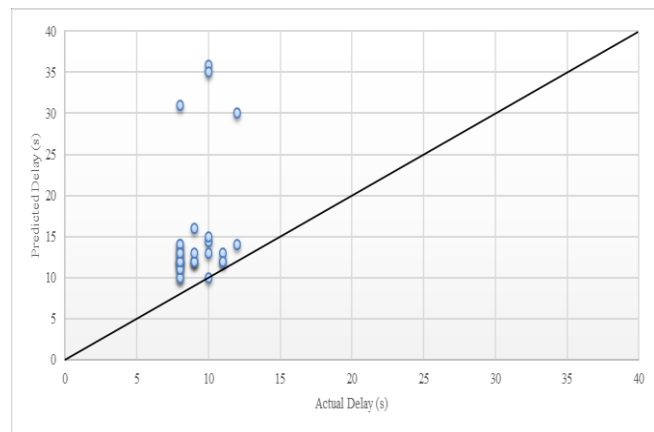

Fig. 5. A comparison between actual and predicted delay

Based on equation 5, the revised PCE value for motorcycles at unsignalized intersections is 0.1. Furthermore, the motorcycle PCE value is entered into the IHCM method. Delay values and queuing opportunities after the revised PCE of the motorcycle are shown in Table 3.

TABLE 3
QUEUES AND DELAYS OF PROBABILITY FOR UNSIGNALIZED INTERSECTION (PCE REVISED)

Intersection	Delay (s/PCU)	A queue of Probability (QP)	
		Lower Limit (%)	Upper Limit (%)
Cirebon	8.27	4.19	12.29
Yogyakarta	8.31	4.33	12.57
Tasikmalaya	8.42	4.74	13.40
Bandung	8.30	4.30	12.50
Makassar	8.64	5.65	15.18
Medan	8.45	4.89	13.70
Semarang	7.98	3.13	9.98
Sidoarjo	9.38	8.84	20.98

Table 3 shows the value of queues and delays that have decreased after the revised PCE of the motorcycle. The prediction delay and the actual delay test are then performed, as shown in Figure 6. The comparison graph of

REFERENCES

- Abhishek., Mandjes, M., Boon, M., and Nuñez-Queija, R., "Congestion analysis of unsignalized intersections", COMSNETS. Intelligent Transportation Systems Workshop, 2016.
- Akcelik, R., "Time-Dependent Expression for delay, stop rate, and queue length at traffic signals," Internal Report Air 367-1. Australian Road Research Board, Vermont South Australian, 1980.
- Badan Pusat Statistik (BPS), accessed from <http://www.bps.go.id/>, Jakarta, Indonesia, 2018.
- Chandra, S., and Kumar, P., "Effect of Lane Width on Capacity under Mixed Traffic Conditions in India", Journal of transportation engineering, 2003, pp.155-160.
- Direktorat Jenderal Bina Marga, "Indonesian Highway Capacity Manual," Jakarta Indonesia, 1997.
- Fambro, D.B., and Roupail, N.M., "Generalized delay model for signalized intersections and arterial streets," Transp. Res. Record, J. Transp. Res. Board, vol. 1572, 1997, pp. 112–121.
- Fitzpatrick, K., Turner, S. P. E., and Brewer, M. A., "Improving Pedestrian Safety at Unsignalized Intersection," ITE Journal, vol. 7, 2007, pp. 34-41.
- Guler, S.I., and Menendez, M., "Methodology for estimating capacity and vehicle delays at unsignalized multimodal intersections," International Journal of Transportation Science and Technology, doi: <http://dx.doi.org/10.1016/j.ijtst.2017.03.002>, 2017.
- Irawan, M.Z., Sumi, T., and Munawar, A., "Implementation of the 1997 Indonesian highway capacity manual (MKJI) volume delay function," Journal of the Eastern Asia Society for Transportation Studies, vol. 8, 2010, pp. 350-360.
- Liu, M., Chen, L., Lu, G., and Wang, Y., "Modeling Crossing behavior of drivers at unsignalized intersections with consideration of risk perception," Transport Research Part F, 2017, pp. 14-26.
- Magfirona, A., Hidayati, N., Setyaningsih, I., and Slamet, G., "The delays for signalized intersection using ATCS Data and Field Survey Method at Kerten-Intersection of Surakarta," *Procedia Engineering*, vol. 125, 2015, pp. 526 – 533.
- Munawar, A., "Queues and delays at signalized intersections, Indonesian experience," Paper presented at the 5th Internasional Symposium on Highway Capacity and Quality of Service, Yokohama, Japan, 2006.
- Mohan, M., and Chandra, S., "Three methods of PCU estimation at unsignalized intersections," *Transportation Letters*, 2016.
- Patil, G. R., and Sangole, J. P., "Behavior of two-wheelers at limited priority uncontrolled t-intersections," *IATSS Research*, vol. 40, 2016, pp. 7-18.
- Saha, A. S. ASCE., Chandra, A.M., Ghosh., and I.A.M. ASCE., "Delay at Signalized Intersections under Mixed Traffic Conditions," *J. Transp. Eng., Part A: Systems*, vol. 143(8), 2017.
- Tan, D.T., Tu, T.V., and Sano, K., "Estimation of Motorcycle Equivalent Unit on Urban Street," *Journal of the Eastern Asia Society for Transportation Studies*, vol. 2, 2018, pp. 243-255.
- Webster, F.V., "Traffic signal settings," Road Research Technical Paper, 39, Road Research Laboratory, Her Majesty's Stationery Office, London, United Kingdom, 1958
- Wang, Z., Chen, S., Yang, H., Wu, B., and Wang, Y., "Comparison of delay estimation models for signalized intersections using field observations in Shanghai," *IET Intelligent Transport Systems*, vol. 10, Iss. 3, 2015, pp. 165–174.
- Xie, D.F., Gao, Z.Y., Zhao, X.M., and Li, K. P., "Characteristics of mixed traffic flow with non-motorized vehicles and motorized vehicles at an unsignalized intersection", *Physica A Journal*, vol. 388, 2009, pp. 2041-2050.

Mapping of Congesting Cost for Road Network Performance in Urban Area (Case Study of Urban Intersection on Yogyakarta)

1st Muchlisin

Department of Civil Engineering, Faculty of Engineering,
Universitas Muhammadiyah Yogyakarta
Yogyakarta, Indonesia,
muchlisin@umy.ac.id
<https://orcid.org/0000-0001-7775-8707>

2nd Devi Ariantika

Department of Civil Engineering, Faculty of Engineering,
Universitas Muhammadiyah Yogyakarta
Yogyakarta, Indonesia,
ariantika16@gmail.com

Abstract— *As an urban area, Yogyakarta is one of the cities in Indonesia that has an agglomeration area by connecting 3 districts (Yogyakarta city, Bantul and Sleman district) in the one ring-road. One of the biggest problems in urban area is about traffic congestion and more specific occurred in the signalized intersection. The purpose of this study tries to approach the cost congestion based on the database, identification and creating map the road network at each intersection that can be used as a transport policy for the government. The research method is using ArcGis program by collecting various data on the Yogyakarta urban intersections that have been studied using the 1997 Indonesian Highway Capacity Manual and some theories about cost congestion and the regulations as well. To produce a GIS map, map of Yogyakarta Administration and Google Earth Image maps are used as the main source. From the 20 intersections studied, the results showed that urban intersections, the road network tended to experience a poor level of service intersection (LOS F) with the percentage in 97%. The percentage of queue lengths tends to be as high as 62%, and percentage degree of saturation with a scope limit (LOS F) of 57% and the most expensive intersection costs congestion is the Gejayan intersection.*

Keywords— *ArcGis; intersection; mapping; road network; level of service*

I. BACKGROUND

As one of the tourist destination cities in Indonesia, Yogyakarta has experienced an increase in traffic congestion from year to year. A lot of problems in agglomeration area, one of the important problems is about traffic or congestion. One of the biggest traffic problems in that agglomeration is located in the intersection, particularly signalized intersections.

One of the factors the highest congestion in urban area is depending on the number population. According to (BPS, 2016) in 2015 the population of Yogyakarta reached 3,679,176 people with a population density of 1,555 people per km. The impact that occurs with the population density in the city of Yogyakarta is the potential for increased congestion that occurs in the urban road network of Yogyakarta. The arrangement of the transportation system on the Yogyakarta road network should be well organized such as creating the road network performance database. Jihan and Widyastuti (2016) stated that mapping the road network is very influential to increase economic activity and services, accurate information in mapping road networks can help structuring a

good transportation system. Congestion that occurs on the Yogyakarta urban road network is a serious problem that must be overcome. Disturbances that cause congestion often occur due to increased traffic demands such as long queues, large delay times, and traffic violations and so on.

One of the effects of congestion is the addition of costs. This additional cost is influenced by the addition of delay time, queue length, vehicle operating costs, speed and traffic volume. This study will estimate how much the cost in signalized intersection based on the database, particularly in study area. The numbers of the intersection will be deployed in this study is 20 intersection locations.

This research is intended to produce a road network map of Yogyakarta as a reference in knowing several congestion points in the study area. The studies conducted are expected to provide accurate information to road users in driving to avoid the intersections identified as having congestion.

II. CONGESTION COST IN URBAN AREA

A. Congestion Cost Approach

Urban transportation has a variety of very complex problems, namely the problem of traffic congestion, parking, public transportation problems, and pollution. Traffic congestion is one of the most serious problems affecting urban transportation. Identifying the location of traffic jams and patterns that occur is a requirement for urban transport managers to take appropriate precautions to reduce traffic congestion. Congestion that occurs on the road is also a serious problem besides having an impact on discomfort as well as congestion at the intersection (Wibisana and Utomo 2016). Traffic congestion will be detrimental to the driver itself and in terms of economy and environment. For drivers of vehicles, traffic congestion will cause stress problems, in terms of economy, in the form of increasing long waiting times due to long congestion, in addition to increasing vehicle operating costs such as (gasoline, engine maintenance) due to vehicles that stop frequently.

Congestion is the condition of the traffic flow on the road being reviewed exceeding the capacity of the road plan and causing the free speed of the road to be 0 km / hour which then causes a long queue. When congestion occurs, the degree of saturation in the road section is reviewed where congestion will

occur if the value of degree of saturation has reached more than 0.5 (Bina Marga, 1997). According to Small & Verhoef (in Dillon, 2015) transportation congestion can be measured by the importance of service quality and travel time expected by road users, so traffic congestion occurs when the quality of transportation services decreases in intensity of use.

The high level of congestion, causing the addition of time or called the time delay. This can affect the high cost of congestion. Based on to Stubs (1980, in Sugiyanto, 2008), he mentions that the cost of congestion is a relation between speed and flow also the relation between speed and vehicle cost. In urban areas, traffic costs are felt to be quite high when compared to rural areas. The high number of vehicle volumes and the number of travel generating areas causes a large number of trips that can burden the road network.

B. Level of Service

It's important to measure the parameters of level of service on the road which needs to be done to prevent congestion at various intersections (Putro, 2009). The level of service at the intersection according to Ministerial Regulation No. 96 of 2015 is explained in Table 1 which regulates the level of service at the intersection according to the delay parameters.

TABLE I. LEVEL OF SERVICE IN INTERSECTION BASED ON DELAY

Level of Service	Delay (Second)	Notes
A	< 5	Excellent
B	> 5 - 15	Good
C	> 15 - 25	Average
D	> 25 - 40	Less Average

E	> 40 - 60	Poor
F	> 60	Very Poor

Source: Ministry Regulation Number 96 in 2015 about The guidelines for Implementing Traffic Management and Engineering Activities

C. Mapping in Transport and Geography Studies

According to Ball and Petsimeris (2010) maps are objects that are familiar to everyone, as a form of getting information, maps are needed, the quality of maps must be assessed primarily in terms of geometric accuracy. Maps are useful in everything, especially in geography and transportation, which are often used to provide accurate information about the mapping that is done. In the field of transportation, maps are used to find the shortest route in the application by utilizing the Geographic Information System (GIS) (Buana, 2010). Maps are also used in the delivery of specific cities through ArcGis Online utilizing information that is on the system (Hamdani and Jamil 2017). The benefit of maps in geography is as a digital map location marker application. Digital maps are images of the earth's surface that are digitally collected and scaled down to a certain scale through a projection system (Hati et al, 2013).

III. RESEARCH METHODOLOGY

A. Location of Study

Research on road network mapping is carried out at intersections with Ring-road boundaries as the research area. The map used is Google Earth imagery, 2018. The location of this study is at 20 intersection where the study area in the agglomeration of Yogyakarta.

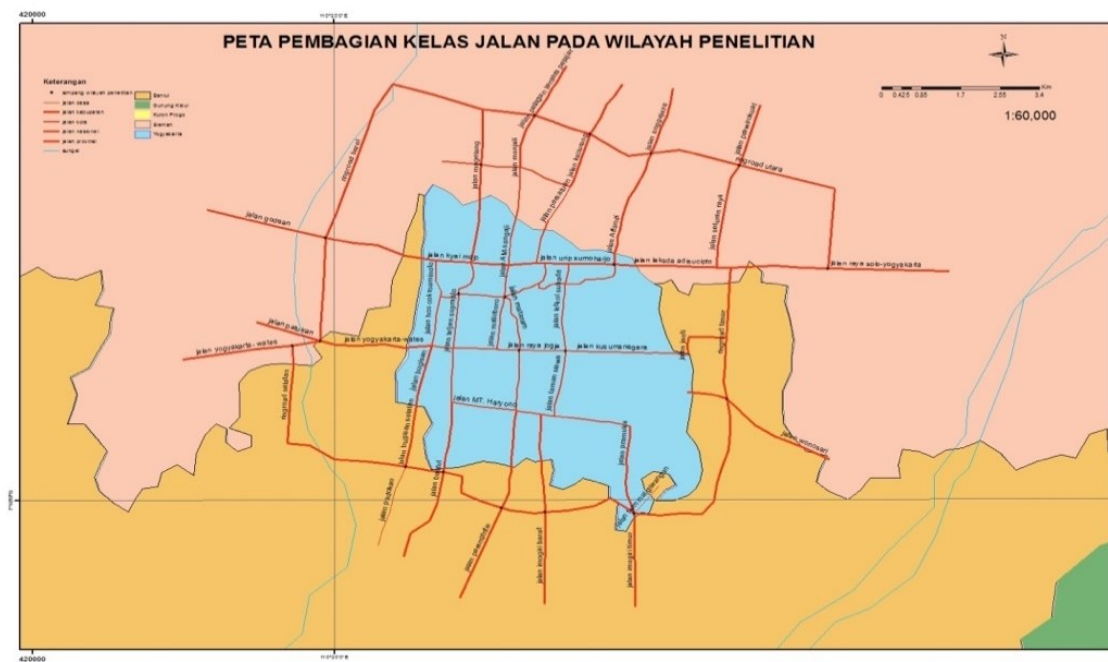

Fig 1. THE ROAD NETWORK OF STUDY LOCATION

TABLE II. LIST OF THE INTERSECTION LOCATION

NO.	LOCATION
1	Intersection of Imogiri Barat, South Ringroad, Bantul Regency
2	Intersection of Parangtritis, Bantul Regency
3	Intersection of Giwangan, South Ringroad, Yogyakarta City
4	Intersection of Bantul Street, South Ringroad, Bantul Regency
5	Intersection of East Ringroad and Laksda Adi Sucipto, Sleman Regency
6	Intersection of Ketandan, East Ringroad, Bantul Regency
7	Intersection of Monjali, Yogyakarta City
8	Intersection of Tamansiswa, Yogyakarta City
9	Intersection of Demangan, Yogyakarta City
10	Intersection of Abu Bakar Ali, Yogyakarta City
11	Intersection of Pelemgurih, Yogyakarta City
12	Intersection of Panembahan Senopati, Yogyakarta City
13	Intersection of Selokan Mataram-Magelang Street, Sleman Regency
14	Intersection of Jlagran, Sleman Regency
15	Intersection of Demak Ijo, West Ringroad, Sleman Regency
16	Intersection of Madukismo, South Ringroad, Bantul Regency
17	Intersection of Gamping Market, West Ringroad, Sleman Regency
18	Intersection of Gejayan, North Ringroad, Sleman Regency
19	Intersection of UPN, North Ringroad, Sleman Regency
20	Intersection of Kentungan, North Ringroad, Sleman Regency

B. Analysis Method

In this study, a method is used to determine the level of intersection service by conducting scoring and classification methods. The parameters used refer to regulations but there are modifications to the ArcGis program. The parameters at the intersection carried out are as follows:

- a. Delay
To identify and score on the parameters of intersection delays is to refer to Ministerial Regulation No. 96 of 2015 in Table I.
- b. Queue Length
To identify the queue length that occurs at the intersection, a division of 3 classes is done in ArcGis, namely low, medium, and high.
- c. Degree of Saturation
To identify intersections with degree of saturation (Volume (V) / Capacity (C)) parameters based on those listed in Table III.

TABLE III. LEVEL OF SERVICE IN INTERSECTION BASED ON V/C RATIO (ABUBAKAR 1996)

Level of Service	The Range of V/C	Notes
A	0.00-0.19	Excellent
B	0.20-0.44	Good
C	0.45-0.74	Average
D	0.75-0.85	Less Average
E	0.85-1.00	Poor
F	>1.00	Very Poor

- d. Capacity
Specific capacity parameters at the intersection are not carried out, but only the input capacity of the intersection data in the ArcGis program.
- e. Traffic flow
Specific traffic flow parameters at the intersection were also not identified but only input data in the ArcGis program and mapping traffic flows. Map results can be seen in the next discussion to display a map of traffic flow.
- f. Congestion Cost Analysis
Based on (Nash, 1997, in Basuki and Siswandi, 2008), Congestion cost is a travel expense due to traffic delay or additional vehicle volume approaching or exceeding road service capacity. This following equation describes the variables that affected congestion cost.

$$C = N * \left[G A + \left(1 - \frac{A}{B} \right) V' \right] T$$

where:
 C = Congestion Cost (Rupiah),
 N = Vehicle Volume (Vehicle),
 G = Vehicle Operating Cost (Rp/Veh.Km),
 A = Existing Speed (Km/Hour),
 B = Ideal Speed (Km/Hour),
 V' = Vehicle Time Value Fast (Rp/Veh.Hour),
 T = Delay Time (Hour).

IV. RESULT AND DISCUSSION

A. Geometric Correction

In this study the map used as a reference in the mapping is a Google Earth Image map, 2018 scale 1: 55,000. following Table IV Calculation of linear shift according to ArcGis 2018 analysis.

TABLE IV. CALCULATION OF LINEAR SHIFT

No	X	Y	X Google Earth	Y Google Earth	RMS
1	502.9	-450.3	425.5	913.7	8.4
2	1188.4	-333.1	437.1	913.9	6.3
3	632.4	-75.7	427.7	914.3	6.9
4	939.5	-686.3	432.9	913.3	7.8
Total RMS Error = 7.4					

According to Nicholas and Chrisman (in Jihan and Widyastuti 2016), for tolerance of linear shift errors is equal to 0.5 mm then multiplied by the scale number on the reference map. Tolerance in linear shift is 0.5 mm x 55 mm number on the reference map scale (55,000) the result is 27.5 m. The results obtained show that the average linear shift on Google Earth maps is 7.4 m, so that value is still in tolerance.

B. Intersection Database

The intersection database is data that has been collected and arranged based on the parameters needed and makes it easy for users to obtain information. The database that has

been created will be displayed in spatial form in the form of the results of identification of intersections. The database that has been dispensed makes it easier to identify and analyze secondary data that has been obtained.

C. Identifying Service Levels in Yogyakarta Agglomeration Area

Analysis of service levels on the parameters contained in the intersection is based on the scoring method.

- Delay
Based on the results of the intersection service level classification, it shows that many levels of service with F score mean bad. Thus, from that various intersections, Yogyakarta has a lot of congestion due to delays in various intersections.
- Queue Length
Based on the results of the queue length classification of various intersections, welding tends to be medium and high at each intersection, only a few have very high queue lengths.
- Degree of Saturation
Scoring is done on the value of degree of saturation, each intersection tends to be at the boundary of C, D, E and F. For scoring B at the Giwangan intersection to the northeast, namely the Giwangan terminal road, and at the Abu Bakar Ali intersection in Mataram.

Scoring on intersection capacity and traffic flow is not done because only the input data of the value of the capacity and traffic flow are then displayed in the mapping results.

D. Percentage and Results of Service Level Map at Intersections of Various Parameters

- Percentage and map results based on delay parameters
Percentage results obtained from maps based on scoring results, the level of intersection is marked in blue with service level F, the level of service with E score is marked in red and the level of service at intersections with scores C and D tends to be low. The service level F is more dominant, the percentage reaches 97% of the scoring result of the intersection service level of the delay parameter. The following are the results of the percentage delay at the intersection described in Fig 2.

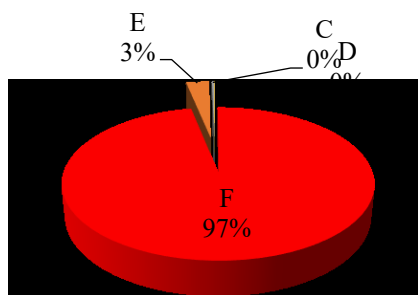

Fig 2. Percentage Diagram of Intersection Delay

And this is the map of performance level based on delay.

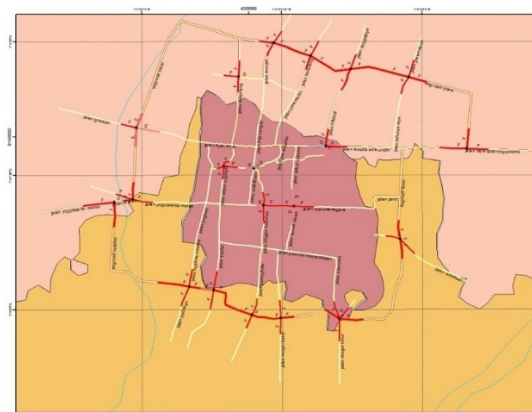

Fig 3. The Map of Road Network Performance Based on Delay Parameter

- Percentage and map results based on queue length parameters

The percentage results that obtained from the scoring in ArcGis and range classification can be seen in this following description.

TABLE V. CLASSIFICATION BASED ON QUEUE LENGTH

No	Range	Class
1	0 – 100	Low
2	101 – 200	Medium
3	>200	High

Based on the results of class classification in the ArcGis program, the results tend to be in the high class with a percentage of 62% and are marked in red on the diagram. Thus, the results of the queue length with the medium class are marked in yellow. For the queue length with high class occurs at the North Ring-road intersection, Kaliurang Street from west direction 648 meters, Laksda Adisucipto Street, East Ring-road with a queue length of 700 meters to the east, and the intersection of Parangtritis, South Ring-road with a queue length of 974 meters to the west.

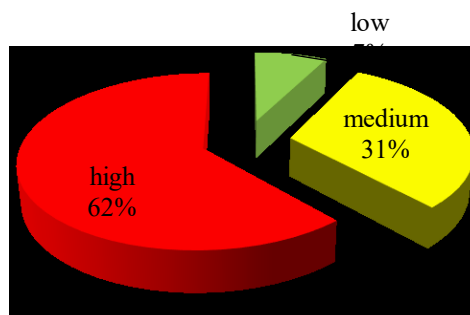

Fig 4. The Percentage of Queue Length Classification

And this is the map of performance level based on queue length.

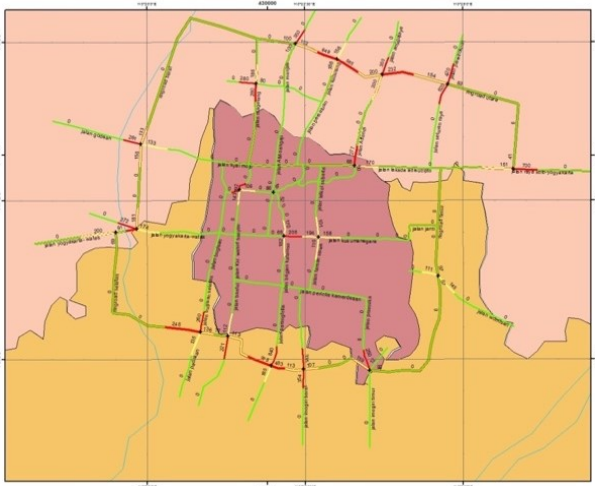

Fig 5. The Map of Road Network Performance Based on Queue Length Parameter

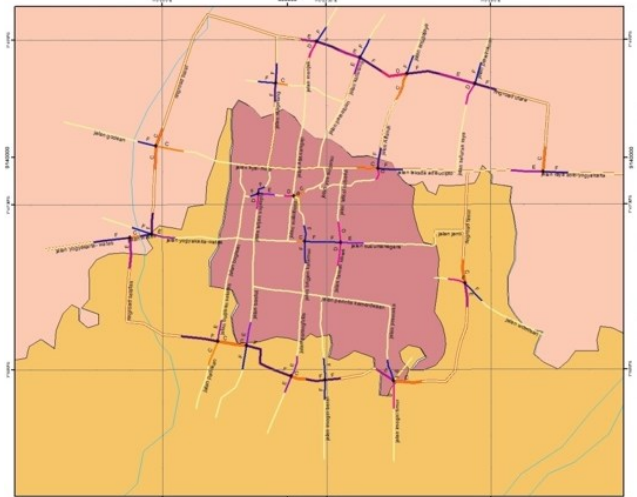

Fig 7. The Map of Road Network Performance Based on Degree of Saturation Parameter

- Percentage and map results based on degree of saturation parameters

Percentage results obtained from analysis and levelling for Degree of Saturation (DS) values. Based on the high DS value that with F level (very poor) is marked in blue with percentage 57%. The degree of saturation E is indicated by the red color of 20%. Almost every intersection tends to be at the level of C, D, E and F. For DS values with level B occur at the Giwangan intersection to the northeast, that is the Giwangan terminal road, and at the Abu Bakar Ali intersection in Mataram road. The following explanation in the form of a diagram can be seen in Fig 6.

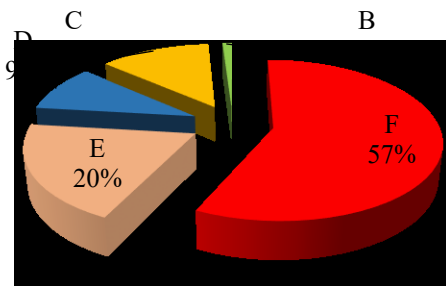

Fig 6. The Percentage of Degree of Saturation Level

And this is the map of performance level based on degree of saturation.

E. Estimating Congestion Cost in the Intersections

Regarding to Muchlisin et al (2017) who tried to make approach of estimating congestion cost in the intersection, these are the result of the cost based on Nash, (1997), in Basuki and Siswandi, (2008). For the calculating BOK (Vehicle Operation Cost) is taken from Sugiyanto (2012) who did research about the correlation operational cost from vehicle and speed. And in this is the result.

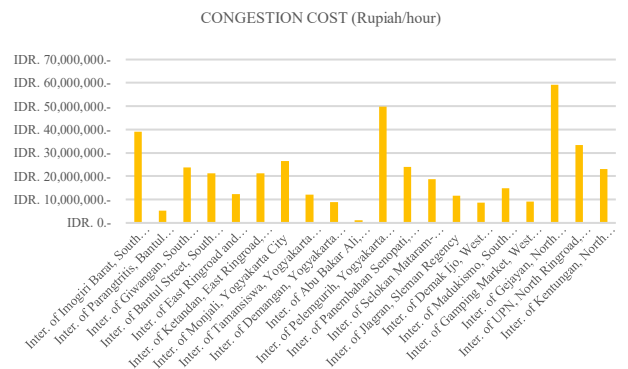

Fig 8. The Result of Cos Congestion Estimation in the Intersections

Based on the result, the most expensive intersection is in the Gejayan intersection with the cost is IDR. 59.252.053,-. Therefore, this intersection should be evaluated to elevated intersection due to the highest delay time.

V. SUMMARY

Based on the results of data processing analysis that has been done with ArcGis software, it can be concluded that:

1. The scope of study location, 20 intersections, a lot of intersections is in the poor and very poor level (E and F) of services based on delay which is increasing more than 60 seconds.

2. Class level according to queue length on the road at each intersection, namely:
 - a. Low class range 0 - 100 meters as much as 7%.
 - b. Medium class with a range of 101– 200 meters which is as much as 31%.
 - c. High class range > 200 meters 62%.
3. Degree of Saturation
At the intersection point which is the research area for the boundary scope in the degree of saturation tends to be at the service level C, D, E and F at each intersection. For score B, it occurs at the Giwangan intersection, precisely in the northeast direction, namely the Giwangan terminal road, and at the intersection of Abu Bakar Ali Mataram Street. Percentage for degree of saturation with score F is as much as 57%, and E as much as 20%.
4. Cost Congestion
Due to the analysis result, the most expensive cost for the congestion is in the Gejayan Intersection. Therefore, the evaluation should be done to optimize the intersection's performance.

ACKNOWLEDGMENT

The deepest gratitude I give to Department of Civil Engineering, Faculty Engineering, Universitas Muhammadiyah Yogyakarta to the support. And also for LP3M UMY as an motivator for accomplishing this paper and also helping for the funding.

REFERENCES

- Abubakar, I., (1996). Menuju Lalu Lintas dan Angkutan Jalan Yang Tertib, Direktorat Jenderal Perhubungan Darat, Departemen Perhubungan, Jakarta.
- Ball, S., & Petsimeris, P. (2010, May). Mapping urban social divisions. In Forum Qualitative Sozialforschung/Forum: Qualitative Social Research (Vol. 11, No. 2).
- Bina Marga, 1997, Manual Kapasitas Jalan Indonesia (MKJI), Direktorat Bina Jalan Kota, Direktorat Bina Marga, Departemen Pekerjaan Umum.
- Badan Pusat Statistik (2016) Provinsi Daerah Istimewa Yogyakarta Dalam Angka 2012-2016, BPS D.I.Yogyakarta, Yogyakarta.
- Buana, P. W. (2010). Penemuan Rute Terpendek Pada Aplikasi Berbasis Peta. Lontar Komputer: Jurnal Ilmiah Teknologi Informasi.
- Dillon, H. S. (2015). Social Optimality of Cordon Area Congestion Pricing in an Monocentric City. *Journal of Regional and City Planning*, 26(1), 43-53.
- Hamdani, A.F., dan Jamil, A.M.M., (2017), Pemanfaatan ArcGIS online Sebagai Media Penyampaian Informasi Spasial Kota Malang, *Ethos*, 5(1), 37-41.
- Jihan, J. C., & Widyastuti, A. S. A. (2016). Pemetaan jaringan jalan terhadap aktivitas perdagangan dan jasa berbasis sig di kecamatan sukolilo surabaya timur. *WAKTU*, 14(2), 50-55.
- Muchlisin, M., Yusup, M., & Mahmudah, N. (2018). Congestion Cost Analysis of Condongcatur Signalized Intersection Sleman, DI Yogyakarta using PTV. Vissim 9. In *MATEC Web of Conferences* (Vol. 181, p. 06003). EDP Sciences.
- Putro, S. (2009). Pemodelan Tingkat Pelayanan Jalan (Level Of Services) Berbasis Sistem Informasi Geografis Untuk Mengurai Kemacetan Lalu Lintas Kota Semarang. *Jurnal Geografi*, 6(2).
- Peraturan Menteri Perhubungan Republik Indonesia Nomor 96, (2015). tentang Pedoman Pelaksanaan Kegiatan Manajemen dan Rekayasa, Lalu Lintas: Jakarta.
- Sugiyanto, G. (2008). Biaya Kemacetan (Congestion Cost) Mobil Pribadi di Central Business District. *Media Teknik Sipil*.
- Sugiyanto, G. (2012). Pemodelan Biaya Kemacetan Pengguna Mobil Pribadi Dengan Variasi Nilai Aktual Kecepatan Kendaraan. *Jurnal Transportasi* Vol.12 No.2, 123-132.
- Syaikhu, M., Widodo, E., & Arifianto, A. K. (2017). Analisa Kapasitas dan Tingkat Kinerja Simpang Bersinyal (Studi Kasus Simpang Tiga Purwosari Kabupaten Pasuruan). *eUREKA: Jurnal Penelitian Mahasiswa Teknik Sipil dan Teknik Kimia*, 1(1).
- Wibisana, H., & Utono, N. (2016). Pemetaan Kecepatan dan Kerapatan Lalu Lintas di Ruas Jalan Arteri Kota Surabaya. *Jurnal Teknik Sipil*, 12(2), 121-145.
- Wikrama, A. A. N. A. J. (2011). Analisis Kinerja Simpang Bersinyal (Studi Kasus Jalan Teuku Umar Barat–Jalan Gunung Salak), *Jurnal Ilmiah Teknik Sipil*, 15(1), 58-71.

Analysis of Geunang Uyat Reservoir Capacity as An Attempt to Overcome Drought During the Dry Season

1st Muhammad Ikhsan
Civil Engineering
Universitas Teuku Umar
Meulaboh, Indonesia
m.ikhsan@utu.ac.id

2nd Muhammad Arrie Rafshanjani Amin
Civil Engineering
Universitas Teuku Umar
Meulaboh, Indonesia
arrierafsanjani@utu.ac.id

3rd Sudirman
Civil Engineering
Universitas Teuku Umar
Meulaboh, Indonesia
sudir0806@gmail.com

Abstract— *The reservoir is one of the storage areas that serves as a water reservoir when there is too much water and can be used during the dry season. The collected water is typically used for downstream requirements such as irrigation water and clean water and can even be used to store energy for power generation. Geunang Uyat Reservoir is located in the Pantan Reu District, west of Aceh. Built to overcome the lack of clean water is one of the most urgent for the need for irrigation water. It is expected that the construction of the reservoir will meet the irrigation requirements that can irrigate around 500 hectares in the village of Meutulang. The method used is the curvature curve to calculate the appropriate storage capacity for a given water demand. The need for irrigation water on agricultural land, planned by the construction of reservoirs, is expected to maximize agricultural production in the region, which is only rice paddy fields. The data used in this study are secondary data from relevant agencies, e.g. Precipitation data obtained from BMKG Cut Nyak dhien, Nagan Raya Regency. From the results of the data analysis, there are several results, namely the analysis of the maximum precipitation amount in November 2006 of 538 mm and the lowest in 2010 in July was 41 mm, from the analysis of the main discharge sampling were obtained 0.032 ml. Based on the analysis, the cumulative value of the inflow was 2,682,868 m³ and the cumulative outflow of 1,575,443 m³ was achieved with a storage volume in the Geunang-Uyat Reservoir of 70.70845 m³.*

Keywords—*reservoir, storage capacity, irrigation, rippl curve.*

I. BACKGROUND

Water is a resource and a factor of agricultural needs as there are no agricultural crops and cattle that do not need water. Although its role is very strategic, water management is still far from expected, causing water to disaster for farmers. The indicator in the dry season is that rice fields are often drought and on the contrary in the rainy season many fields are in the water.

Quantitatively the problem of water for agriculture, especially during the dry season for the distribution of water between needs and replenishment by time and place. An example in Paton Reu Sub-district is often the lack of rice harvest due to lack of water during the dry season. In order to regulate the availability of water to meet the water needs, it is necessary to develop an effective and efficient reservoir to solve the problem. As an alternative, the construction of

this reservoir is expected to maximize the existing water potential and provide benefits to the surrounding community.

In the dry season drought often prevails in most areas of Pantan Reu. In order to solve the problems that exist in the village of Meutulang and its surroundings, the West Aceh District Government in the Public Works Department is planning to locate in the Meutulang Village in West Aceh County. Planning for Geunang Uyat reservoir can cover ± 515 hectare rice water needs in Meutulang and the surrounding area.

The above state is a picture of the village of Meutulang in the Pantan Reu district of West Aceh district, one of the villages where there is still no water supply available during the dry season, which is often unharvested. Geunang Uyat reservoir is one of the water springs in the village of Meutulang. The construction of this embankment from the city is about 28 kilometers long and has an embarkation of ± 70 hectares. The purpose of this study was to analyze the storage capacity of the reservoir using the ripple-curve method.

II. LITERATURE REVIEW

A. Reservoir

Designing a reservoir on plantation land requires evapotranspiration data. Evapotranspiration is the condition for the loss of water from agricultural land due to evaporation and transpiration. The need for plant water is also the basis for knowing how much water there is in the proposed reservoir and what land area can be used for the agriculture and raw water needs of the surrounding community (Yulianur, 2005).

Reservoir serves as a water reservoir in the upstream river basin. The location of the embedding can be based on the natural topographical conditions so that it can absorb as much water as possible so that the closest flow distance must be found.

B. Avarrage rainfall

The average precipitation is the amount of rainwater that falls within an area calculated at each time point (monthly or yearly). The rain data recorded on the rain gauge is the high rainfall around the station. There are three methods to

calculate the average rainfall, the arithmetic method. Usually this method is used in flat areas and many measuring stations. The calculation in this way is more objective than the Isohyet method. The observation points in the study area are not evenly distributed (Yulianur, 2005).

$$R = \frac{1}{N} (R1 + R2 + \dots + Rn) \tag{1}$$

with :

R= Rainfall areas (mm)

R1 +R2+...+Rn= Rainfall in each observation point (mm)

N= Number of observation point

C. River Discharge

Dependable flow is a discharge that is always available throughout the year that can be used for community needs. In this study the mainstay discharge is a discharge that has a probability of 80%. discharge with a probability of 80% is a discharge that has a probability of dam occurring by 80% of the 100% occurrence. The number of events referred to as the minimum amount of data required for analysis is five years and in general to obtain a good value the data used should be 10 years. Determine the possibility of being fulfilled or not fulfilled, the observed discharge is arranged in the order from the biggest to the smallest, (Melisa, 2010).

Actual Evapotranspiration

$$\Delta E = ETo \times (m/20) \times (18 - n) \tag{2}$$

$$E = ETo - \Delta E \tag{3}$$

Soil moisture storage (SMS)

$$SMS = ISM + R - E \tag{4}$$

Water in excess (WS)

$$WS = ISM + Re - SMC \tag{5}$$

Infiltration (inf)

$$Inf = WS \times IF \tag{6}$$

Groundwater storage at the end of the month (G. STOR_t)

$$G.STOR_t = (G.STOR_{t-1} \times Rc) + (0,5 \times (1 - RC) \times inf) \tag{7}$$

Basic Runoff (Q_{base})

$$Q_{base} = inf - G.STOR_t + G.STOR_{(t-1)} \tag{8}$$

Surface Runoff (Q_{direct})

$$Q_{direct} = Ws \times (1 - IF) \tag{9}$$

Current outflow (Q_{storm})

$$Q_{storm} = RXPF \tag{10}$$

Total Runoff (Q_{total})

$$Q_{total} = Q_{base} + Q_{direct} + Q_{storm} \tag{11}$$

River Discharge (Q_s)

$$Q_s = Q_{total} \times A \tag{12}$$

D. Reservoir Capacity

The reservoir capacity of a reservoir is the total capacity that can be accommodated. The storage capacity consists of the active capacity, ie the storage volume that can be used for the water requirement and the dead storage, namely the storage volume for sediments. (Soediby, 2003).

The storage capacity of the reservoir can be divided into two categories, namely the life storage, namely the amount of water that can be used to irrigate the water, raw water, water or other water needs and disposal, namely the storage volume used to contain sediment becomes (Mudjiatko, 2015).

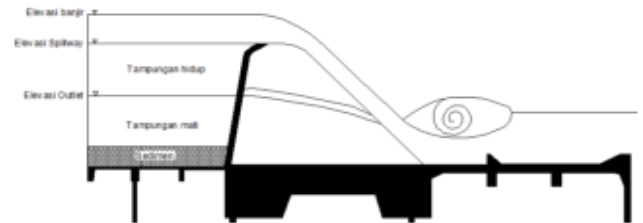

Fig. 1. Reservoir Capacity (Mudjiatko, 2015)

E. RIPPLE CURVE METHOD

This method was first proposed by Rippel (1883) to calculate the amount of sufficient reservoir capacity for a given water demand. The curvature curve period is a line representing the flow rate at a given time, provided that the cumulative train is greater than the cumulative inflow, the reservoir can not meet the demand (Linsley, 1989). The ripple method assumes, among other things, that the reservoir is considered full at the beginning of the critical period and that the reserve capacity is calculated to meet harvesting needs during the dry season. While the limits used are normally kept constant, it is not possible to calculate reliability based on the size of the reservoir. However, the storage volume is not calculated with the probability of default (Mudjiatko, 2015).

1. Inflow

The flow that enters the reservoir includes surface flow, subsurface flow, and water entering the reservoir

2. Outflow

The flow out of the reservoir includes subsurface flow, surface flow and water coming out of the reservoir

3. Availability of water

The availability of water is the amount of water (discharge) which is estimated to continue to exist in a location (weir or other water building) in a river with a certain amount and within a certain period (Triatmodjo, 2008).

$$Kt = Rt - Qt + Kt - 1 \tag{13}$$

with:

Kt = Need for storage capacity at the end of the time period t

Kt-1 = Capacity requirements tamping before the end of the time period

Rt = Release / water requirements for a period of time t

Qt = Inflow during the time period t

T = time period

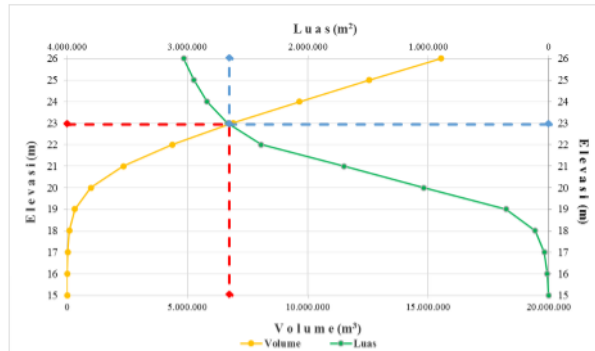

Fig. 2. Reservoir capacity curvature (Mudjiatko, 2015)

III. RESEARCH LOCATION

The location of this research was conducted in Meutulang Village, Panton Reu District, West Aceh Regency, as shown in Fig. 3 below.



Fig. 3. Research Location

IV. RESULT AND DISCUSSION

Based on rainfall data, the maximum monthly data used each year is taken from BMKG Cut Nyak Dhien Meulaboh. Data collected for 10 years, from 2005-2014. Based on the maximum rainfall in 2006 the maximum rainfall obtained for more details can be seen in Table I.

TABLE I. MAXIMUM MONTHLY RAINFALL

Year	Month												max
	Jan	Feb	Mar	Apr	Mei	June	July	Aug	Sept	Oct	Nov	Dec	
2005	105	186	24	59	78	50	22	246	116,1	343	215	188	343
2006	130	100	46	45	119	136	65	41,1	105	69	538	178	538
2007	230	200	154	54	146	207	41	195	122	203,1	318	261	318,3
2008	244	160,1	46	143,3	331	185	277	298	91	398	232	241	398
2009	64,4	97	62	68	144	120,1	81	25	123,4	276	167	68,5	276
2010	230	200	154	54	146	207	41	195	122	47,1	251	260	260
2011	294	11,1	87	154,2	95	54	53	82	60	80	336	96	336,4
2012	224	95	125	148	140	51,1	223	103	157	60	258	309	309
2013	130	92	41	82	79	138	66	44,1	97	62	468	149	468
2014	233	191	149	51	146	265	37	192	124	206,3	238	196	265

The maximum precipitation calculation is used to obtain the maximum amount of rain that increases the intensity of the precipitation. Table I. shows that the highest monthly precipitation in 2006 reached 538 mm/s. The maximum monthly rainfall is shown in Figure 4 of the upper and lower monthly precipitation over a period of 10 years.

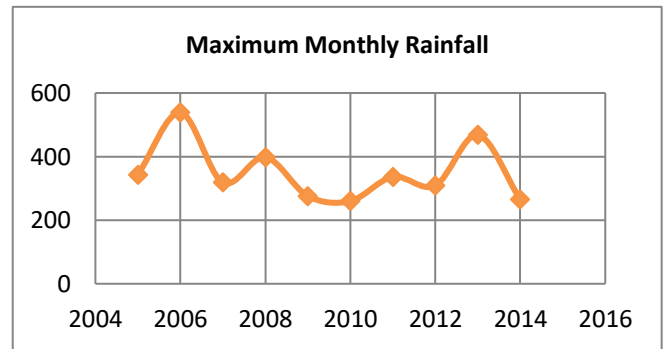

Fig. 4. Maximum Monthly Rainfall

A. Potential Evapotranspiration

To calculate the evapotranspiration, one must know the humidity that occurs in an area. Before you calculate possible evapotranspiration, you first need to gather some supporting data such as temperature, humidity, wind speed, and sunshine.

Data on temperature, wind speed, humidity and solar radiation are needed in ETO calculations as these data have a major impact on evaporative inspiration. Based on the levels of evapotranspiration calculation, more details can be displayed in the Table II.

TABLE II. POTENTIAL EVAPOTRANSPIRATION

Month	Eto (mm/day)	Eto (mm/month)
Jan	3,937	115,338
Feb	4,119	115,332
March	4,804	148,927
Apr	4,111	123,321
May	3,667	113,671
June	3,638	109,136

July	3,718	115,265
Aug	4,158	128,892
Sept	4,289	128,660
Oct	4,450	137,962
Nov	3,716	111,470
Dec	3,466	107,453

One can see the magnitude of the potential evapotranspiration (ET0) that occurred in the district of Pantan Reu, West Aceh. The maximum possible evapotranspiration (ET0) occurs in March, reaching 4,804 mm/day or 148,927 mm/month.

Evapotranspiration occurs when sufficient water is present (through involvement or irrigation) to achieve optimal growth. The more agricultural land is drained from water, the greater the water requirement for evapotranspiration.

B. River Discharge

The estimated amount of river drainage using the mock method is the use of the rainfall runoff simulation method for each catchment, the soil moisture climate and the vegetation of the local land use. The mock method takes into account the precipitation data, evapotranspiration and hydrological properties of the drainage areas. The results of this modeling can be considered reliable if there is an observation discharge as a comparison. Due to the limited data in the study area, the comparison can not be carried out. This calculation requires a more accurate approach to hydrological parameters so that simulation results can be received with moderate accuracy but still be used for further analysis.

TABLE III. RIVER DISCHARGE

Month	River Discharge (80%) m ³
Jan	0,013
Feb	0,008
March	0,004
Apr	0,003
May	0,003
June	0,003
July	0,002
Aug	0,002
Sept	0,002
Oct	0,001
Nov	0,032
Dec	0,012

Every month the level of exposure in the dam of Geunang Uyat, Pantan Reu district, West Aceh. The maximum load of the Geunang-Uyat Reservoir is 0.032 m³. This is in November. This outflow will later meet the need for irrigation water and raw water supplies in the Pantan Reu district, West Aceh Regency.

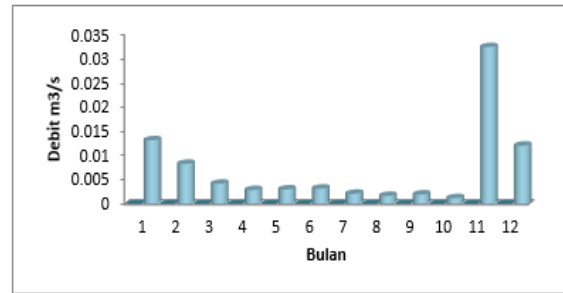

Fig. 5. River Discharge Graph

It can be noted that the main delivery rate is in Geunang Uyat reservoir in Pantan Reu, West Aceh. The difference between high and low discharge can be seen in the graph, the highest discharge occurred in November at 0.032 m³.

C. Existing Capacity of Reservoir

The existing capacity of the reservoir is the capacity of the water under the initial conditions. In this study, we can see the existing capacity of the reservoir at Geunang Uyat reservoir, Pantan Reu District, West Aceh Regency. Further details can be found in Table IV.

TABLE IV. EXISTING CAPACITY OF RESERVOIR

elevation (m)	depth (m)	Large (m ²)	Volume (m ³)	Commulative Volume (m ³)
38	0	1,536.0	0	0
39	0.70	3,600.0	62,396	62,396
40	1.40	4,160.0	96,916	159,312
41	2.10	4,800.0	111,905	271,216
42	2.80	5,500.0	128,651	399,867
43	3.50	5,760.0	140,737	540,605
44	4.20	6,080.0	147,982	688,587
45	4.90	6,240.0	153,996	842,582
46	5.60	6,720.0	161,963	1,004,545
47	6.30	6,840.0	169,498	1,174,043
48	7.00	7,480.0	178,940	1,352,983
49	7.70	7,560.0	187,999	1,540,982
50	8.40	7,680.0	190,498	1,731,480

51	9.10	8,000.0	195,986	1,927,467
52	9.80	9,000.0	212,377	2,139,844
53	14.80	9,000.0	225,000	2,364,844
54	10.80	9,000.0	225,000	2,589,844
55	15.80	9,360.0	229,485	2,819,329
56	11.80	9,500.0	235,748	3,055,077
57	16.80	9,500.0	237,500	3,292,577
58	12.80	9,900.0	242,483	3,535,060
59	17.80	10,000.0	248,749	3,783,809
60	13.80	10,000.0	250,000	4,033,809
61	18.80	11,000.0	262,401	4,296,210
62	14.80	11,040.0	275,500	4,571,710
63	19.80	11,220.0	278,247	4,849,957
64	15.80	11,960.0	289,701	5,139,657
65	20.80	12,960.0	311,416	5,451,074
66	16.80	12,960.0	324,000	5,775,074
67	21.80	13,440.0	329,982	6,105,056
68	17.80	14,000.0	342,976	6,448,032
69	22.80	14,520.0	356,480	6,804,512
70	18.80	14,720.0	365,497	7,170,009
71	23.80	14,820.0	369,249	7,539,258
72	19.80	14,820.0	370,500	7,909,758
73	24.80	15,190.0	375,115	8,284,874
74	20.80	16,000.0	389,831	8,674,705
75	25.80	16,500.0	406,234	9,080,939
76	21.80	18,360.0	435,543	9,516,482
77	26.80	18,424.0	459,800	9,976,282
78	22.80	19,200.0	470,267	10,446,549
79	27.80	19,800.0	487,481	10,934,029
80	23.80	20,500.0	503,725	11,437,754
81	28.80	22,440.0	536,567	11,974,321
82	24.80	23,040.0	568,484	12,542,805
83	29.80	23,780.0	585,226	13,128,030
84	25.80	24,080.0	598,246	13,726,277
85	30.80	25,160.0	615,451	14,341,727
86	26.80	25,920.0	638,476	14,980,204
87	31.80	32,800.0	732,315	15,712,518
88	27.80	33,440.0	827,987	16,540,506
89	32.80	34,400.0	847,972	17,388,477
90	28.80	35,720.0	876,448	18,264,926

The calculation data in Table IV are then plotted into a curved graph of reservoir capacity

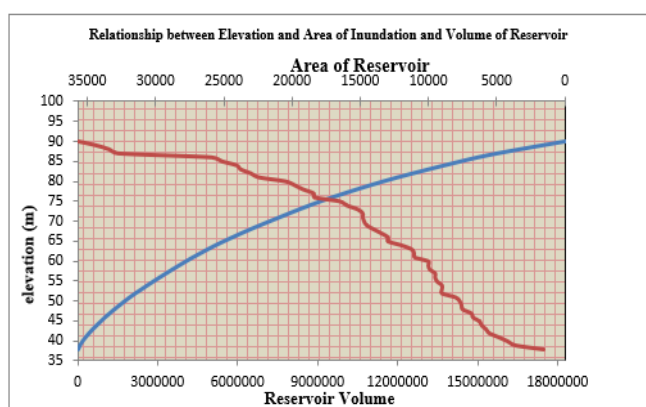

Fig. 6. Curvature of Reservoir Capacity

The calculation of the reservoir curve is made by accumulating the volume of the reservoir bounded by the contour lines of each counter. The analysis of the reservoir capacity is obtained from secondary topographical data. The results of this analysis show a graphical representation

of the relationship between the height and volume of a reservoir, as shown in Fig. 6.

The capacity of reservoir curve of the optimum storage capacity is determined by the threshold between the flood volume and the pond flooding area at ± 75.10 meters above sea level. based on the area and volume calculations given in Table IV, where the reserve capacity at ± 75,10 m with embedded reservoir is ± 338,321 .97 m³ and puddle area ± 749,430.00 m².

The calculation of the reservoir capacity based on the topographical conditions is performed by analyzing the topographical conditions of the measurements taken. Subsequently, a certain height is determined, which can be optimized as an extension of the reservoir pool. Similarly, when calculating the available storage capacity, the amount of water that can be taken is based on topographical conditions.

V. CONCLUSION

1. From the Geunang-Uyat altitude analysis, a inundation area of ± 75.10 m and a depth of elevation of ± 75.10 cm were obtained, giving a reservoir of ± 338.321.97 m³.
2. The area of Geunang Uyat reservoir is ± 700,000 m² and the total mainstay discharge in the Geunang Uyat Reservoir is 70,708,245 m³ with an overflow crest elevation of 30.58 m³ and a containment height of 0.08 m³. Based on the cumulative cumulative value of 2.682.868 m³ and the cumulative outflow of 1,575,443 m, this discharge is used to flow rice fields in Panton Reu District with a rice field area of 515 hectare.
3. The reservoir size in the Geunang Uyat Reservoir is calculated using the ripple curve method. This method determines the size of the reservoir, which is sufficient for specific water requirements. Total runoff in the Geunang-Uyat Reservoir with three simulations is 70,408,245 m³.

ACKNOWLEDGMENT

Greeting my gratitude to Allah SWT who has given the age and health so that this research can be done well. thanks also authors say to parents as a source of spirit. Also on this occasion the authors thank profusely to the friends to contribute ideas and constructive feedback for the perfection of this study. and also do not forget the authors say to students who have been helping with the completion of this study.

To Bapak Dr. Ir. M. Isya, MT that has been offered an opportunity for authors to work and do a lot of things for the progress and self development.

VI. REFERENCES

Melisa. D, 2010. *Evaluasi Kapasitas Perencanaan Embung Untuk Kebutuhan Perencanaan Irigasi Di Desa Seifulu Simeulue Tengah Nanggroe Aceh Darussalam (Nad) Fakultas Teknik Universitas Sumatera Utara (USU) Kampus Meda.*
 Mudjiatko, 2015. *Kapasitas Tampungan Embung, Jurusan Teknik Sipil Universitas Riau.*
 Soedibyo, 2003. *Kapasitas Tampungan Embung*, Yogyakarta.
 Yulianur, 2005. *Debit Kebutuhan Irigasi*, Banda Aceh.

BIM Based Risk Integration Model in Temporary Structure

1st Ni Putu Ika Frisilia

Institut Teknologi Sepuluh Nopember (ITS), Department of Civil Engineering,
Surabaya, Indonesia,
frisiliaikaputuni@gmail.com

2nd Tri Joko Wahyu Adi

Institut Teknologi Sepuluh Nopember (ITS), Department of Civil Engineering,
Surabaya, Indonesia,
tri_joko@ce.its.ac.id

Abstract—Construction activities are very complex and risky. Therefore, the number of accidents in the construction industry is higher compared to other industries. On the other hand, the construction industry 4.0, forced construction technology to develop into the world of digitalization, especially Building Information Modeling (BIM). However, the relationship between safety management and technology-based information models has not been widely developed. This study aims to propose a model that integrates construction risks and BIM. This research was carried out by identifying risky temporary structure, such as: the stability of scaffolding and formwork. In this model, data or information will be obtained through sensors and visual observations. Bayesian Belief Network (BBN) will be used to combine risk and to calculate the probability of a hazard. To validate the proposed model, a building construction project in Surabaya was used as a case study. Beside integrating project risks and BIM, this model can also be used as an early warning system in construction projects.

Keywords— construction industry, building, safety management, BIM.

I. INTRODUCTION

The construction industry is statistically one of the most dangerous industries [4][7][11][19]. The Health Safety Environment (HSE) report has shown that the construction industry has a greater hazard than other industries [18][27]. One of the jobs that many experience work accidents is work at height, many problems arise when workers work at height, for example workers do not use personal protective equipment (Full Body Harness), lanyards are not perfectly linked to the handrail, work does not comply with existing procedures, scaffolding (scaffolding) and formwork (formwork) that are not safe to use.

Even in a study conducted by the Bureau of Labor Statistics, 72 percent of workers were injured in accidents that occurred in scaffolding caused by the boards on which they had fallen from falling from above scaffolding [31]. Besides [20] and [1] concluded that preparation of formwork for concrete structures is a stage that is also dangerous in relation to workplace accidents. According to [2] the highest risk of all formwork activities is at the stage of preparation of floor plate formwork. Because construction project work continues to increase in terms of complexity, construction methods and design improvements, it will certainly increase risk throughout the construction phase [10].

Technology in the construction industry is currently in development called construction 4.0 [16]. Implementing 4.0 Construction adopted from Industry 4.0 is a new concept

using Internet of Thing (IoT), so that it can integrate information between different platforms and adopt new gadgets such as laser scanners, drones, 3D printing in the hope of increasing the ability to monitor construction projects at design, construction and operations operational [30]. This is a process of applying modern technology to encourage digitalization of the construction industry and its supply chain. So to overcome this, the use of BIM is very much needed by planners, construction management and contractors to be more efficient in completing tasks [37]. BIM is often used in construction projects because of its ability to provide simulations of building technical information regarding estimated costs, materials and completion time. This shows that BIM is one of the first innovations behind construction 4.0 [30]. In relation to risk, BIM can reduce risk, one of which is to reduce the risk of errors and omissions.

In achieving the direction of technology, data processing techniques with more effective approaches are developed, with a note of danger usually the result of several uncertain factors [6]. The Bayesian Belief Network model in construction has focused primarily on output [26]. The use of Bayesian in the construction field is because it can describe between variables qualitatively and quantitatively [17]. In addition Bayesian Belief Network (BBN) can also be used in the face of information uncertainty, and can be used for analysis of complex environmental reliability and failure [23][24]. Therefore, the approach can be done using Bayesian Belief Network to describe potentially dangerous situations / situations (and relationships between circumstances).

II. LITERATURE REVIEW

A. Fatalities in Construction Project

Previous research shows a background that influences the making of a safety integration model with BIM, because 65% of workers in the United States in the construction industry work on scaffolding. Of the involved workers 4,500 were injured and 50 died each year [29]. According to [34], there were 14,760 claims regarding compensation in the Australian construction industry in 2007-2008. Claims related to scaffolding and formwork account for 3% of all claims (410 claims). This is due to the nature of complex and dynamic construction,

temporary work teams, physical structures and changing spaces, and weather changes in the work environment [12]. In addition, the scaffolding system contains many elements, so

how to build it also affects the strength and safety of its construction [29].

WHSQ has developed an audit system to assess the impact of 73 workshops and 246 scaffolding locations in Queensland. The audit results show that the percentage of low compliance with formwork related regulations is 59% while for non-compliance is 18% for work safety plans. In the previous research, semi-automatic scaffolding selection modeling using algorithm was developed by [21] in order to find out the right type of scaffolding associated with the specific conditions of a project.

B. BIM for Safety

To prevent injury and save the lives of construction workers, there is a high interest in improving safety in the workplace through safer designs and work methods using Building Information Modeling (BIM). Research investigates the potential of BIM applications for safer construction design and safety planning [13][22][25][32][40].

The development of the 5D safety model (integrated 3D design with safety schedules and information) that links 3D safety features with construction plans has been carried out [5][9][38], for example incorporating the fence installation process into a schedule construction of precast units using BIM for fall protection [38]. However, there are still restrictions that prohibit achieving the full benefits of BIM in developing development plans that reduce the potential for safety risks without compromising other objectives, such as costs and duration.

One critical limitation is the systematic lack of temporary structural integration at BIM. In the real world, in construction projects, temporary structures (such as scaffolding and formwork) are often used and have an impact on overall project safety and productivity [29][33]. [38] discussed the request for temporary structure safety processes included in the BIM for a better understanding of project progress, future work plans, and related security processes. [9] emphasize the importance of real-time monitoring and discuss comparisons between planned BIM designs and 3D information constructed captured by laser scanning technology that supports safety conditions, where detecting missing security components such as guardrails or safety nets around work area.

[36] prepared a BIM model that is integrated with safety, for example a 3D building model with hazardous area information and then advised to track the movement of construction workers in real-time using RFID and wireless tags for safety monitoring purposes. [14] developed a real-time security monitoring system by implementing tape-based technology, where the system activates real-time position tracking of workers and prevents unauthorized access to dangerous zones. Whereas [32] applied the BIM application to improve worker safety by designing a safer site layout. [15] introduced an interactive training model for scaffolding safety training.

In the use of BIM, decision making in uncertain conditions is also needed as a form of integration. In previous studies decision making in uncertain conditions has been carried out by sharing methods including Multiattribute Decision Making (MCDM) (AHP, ANP, TOPSIS, SMART, etc.), Mathematical

Programming (MP) (DEA, LP, NLP, etc.) , and Artificial Intelligence (AI) (GA, NN, BN, DT, etc.) [8]. In making decisions on uncertain conditions, BBN (Bayesian Belief Network) is used in construction, in this case focused on improving construction operations [26]. In addition BBN (Bayesian Belief Network) is also used to estimate job productivity that is not right [39], diagnosing disorders in the anaerobic system [35], making conclusions on the cost of road construction [3], estimating pessimistic and optimistic values of time period activities based on project characteristics [28] and risk analysis in construction contracts [2].

III. METHODOLOGY

In this study, to obtain information about risks in temporary structure work (scaffolding and formwork), interviews were conducted with experts in the field of risk management.

A. Bayesian Belief Network (BBN)

Risk modeling with Bayesian Belief Network (BBN) is done with the following basic formulas (Equations 1 and 2):

$$P(A|B) = \frac{P(A \cap B)}{P(B)} \tag{1}$$

$$P(A_1|B) = \frac{P(A_1) \times P(B|A_1)}{P(A_1) \times P(B|A_1) + P(A_2) \times P(B|A_2) + \dots + P(A_i) \times P(B|A_i)} \tag{2}$$

Bayesian Belief Network has two inputs, namely the previous probability and conditional probability. The first term refers to the probability value for the no parent node (independent variable). Meanwhile, the second term refers to the probability value for a node that has a parent node (non-independent variable). Conditional probability means that every time a statement about the probability of P (A) of an event A is given, then implicitly given conditions regarding other factors. The input value of this probability is obtained from the database or expert opinion.

IV. RESULT & ANALYSIS

A. Model Implementation

The model used in this study is a 5-story building under construction located in Surabaya [Fig. 1]. This study focuses on the process of scaffolding and formwork work for plates and floor beams. Modeling is done using BIM software, Revit, which will be used as a database.

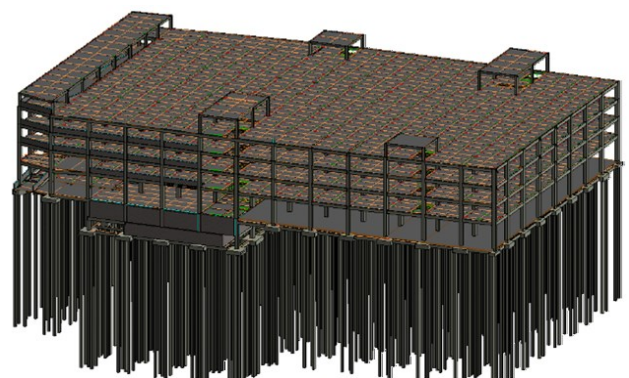

Fig. 1. Modeling of the 5-storey building with Revit

B. Model Simulation

Model decision making simulation is done by Bayesian Belief Network method using Hugin Lite. Decision making is carried out per structural slab casting zone, so the results are in [Fig. 2] and [Fig. 3].

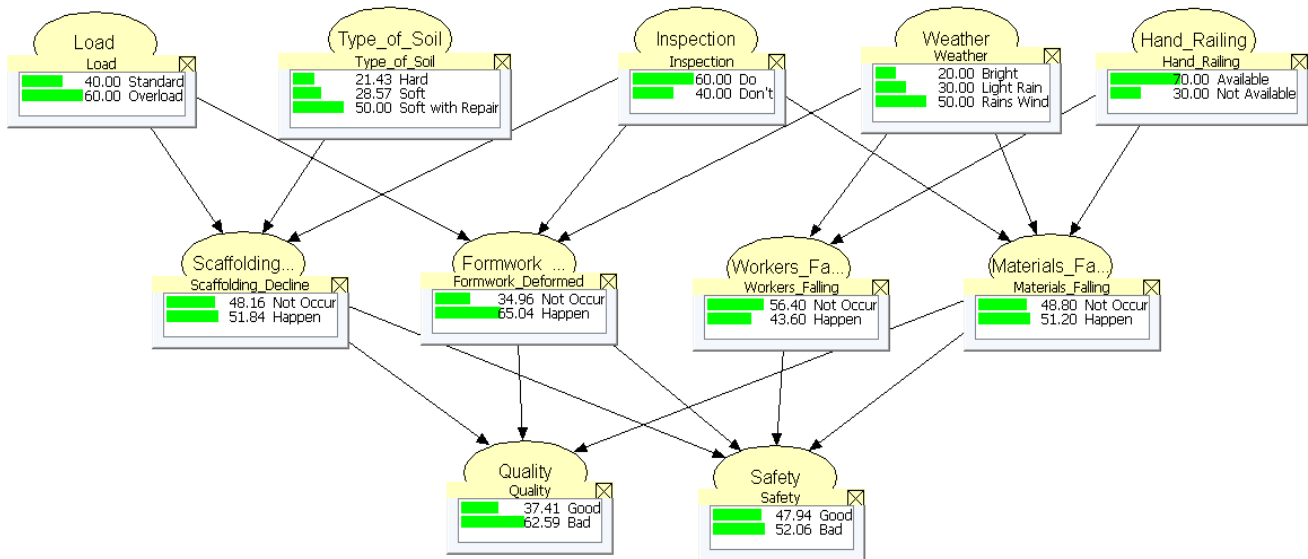

Fig. 2. Zone A Decision Making Results Dangerous Conditions

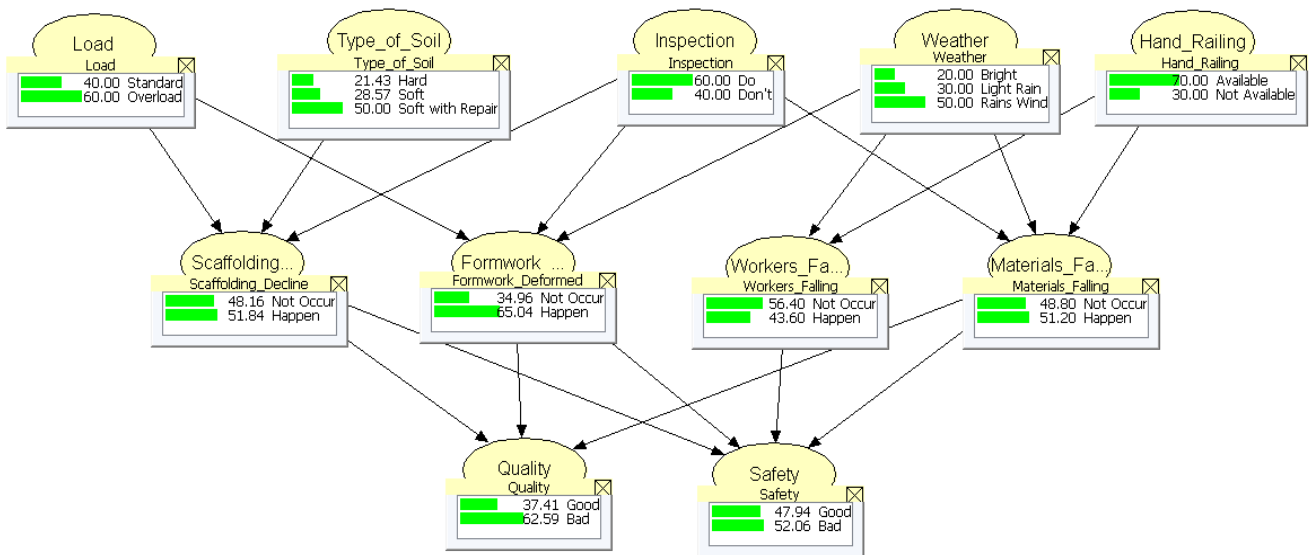
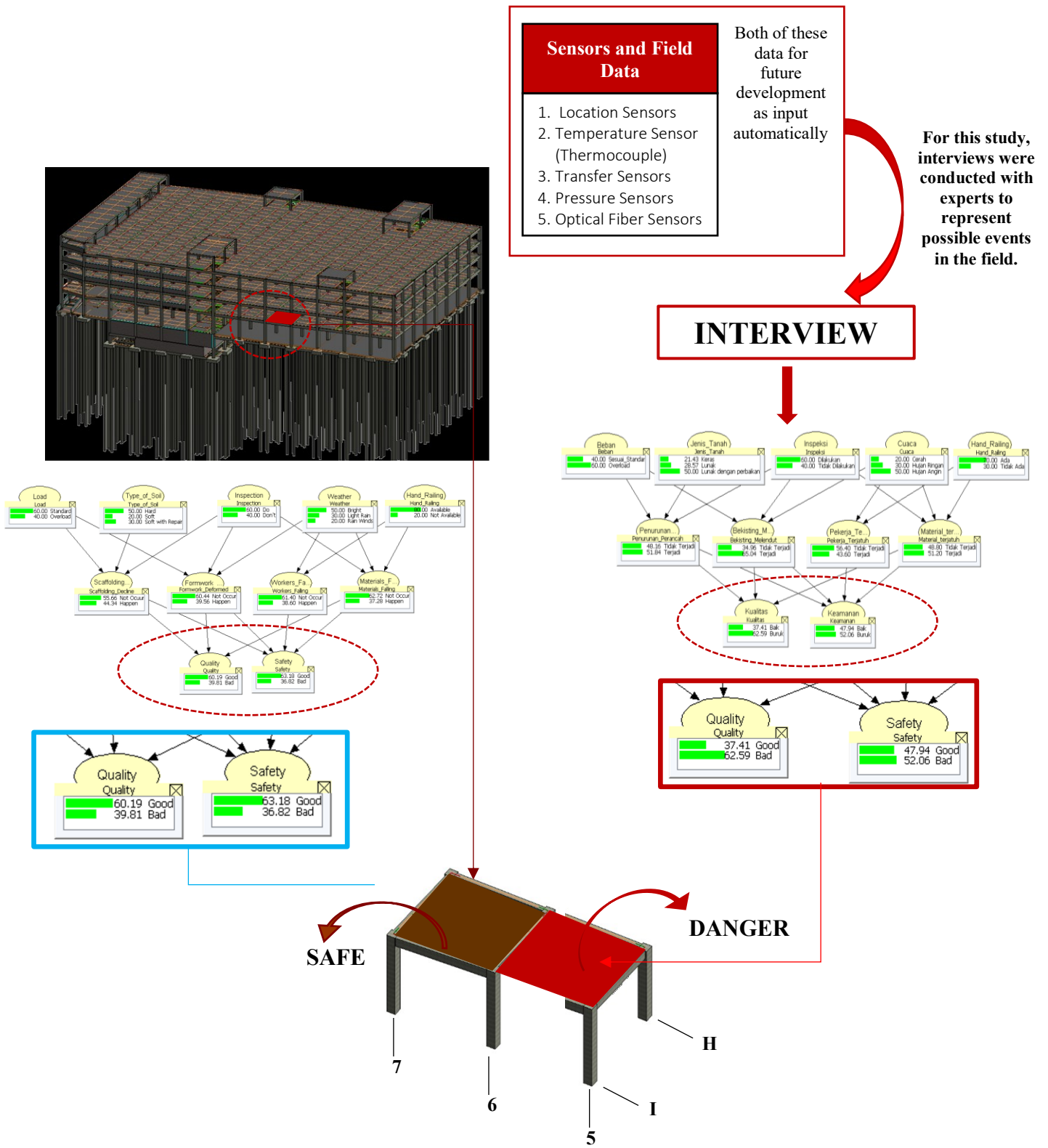

Fig. 3. Zone B Decision Making Results in Safe Conditions

C. 3D Visualization

From the building modeling that has been done using Revit, the data from the modeling results will be entered using the Bayesian Belief Network. So that the location that is

reviewed is dangerous or safe. This research is still in the development stage, therefore simulation is needed to validate the model with data sourced from expert interviews [Fig. 4].



Part of the building ex: AS 5-7/H-I
 Inform the location of work that is dangerous due to the work of scaffolding and formwork.
 Dangerous locations are shown in red.

Fig. 4. Visual 3D Model Simulation Results

V. CONCLUSION

From this simulation, it is expected to be an early warning system on the work of scaffolding and formwork on construction projects. The expected early warning system in this study is a visual warning about the area being carried out by scaffolding and formwork work that is in danger and will have an impact on poor quality. So that work safety and the quality of concrete work can be better.

REFERENCES

- [1] Adam, J. M., Pallares, F. J., & Calderon, P. A. (2009). Falls from height during the floor slab formwork of buildings: Current situation in Spain. *Journal of Safety Research*, 293–299.
- [2] Adam, J. M., Pallarés, F. J., Calderón, P. A., & Payá, I. J. (2007). A study of the conditions of use of a new safety system for the building industry. *Engineering Structures*, 29(8), 1690–1697. <https://doi.org/10.1016/j.engstruct.2006.09.018>
- [3] Attoh-Okine, N. O. (2002). Probabilistic Analysis of Factors Affecting Highway Construction Costs: A Belief Network Approach. *Canadian Journal of Civil Engineering*, 29(3), 369–374.
- [4] Baradan, S., & Usmen, M. A. (2006). Comparative Injury and Fatality Risk Analysis of Building Trades. *Journal of Construction Engineering and Management*, 132(5), 533–539. [https://doi.org/10.1061/\(asce\)0733-9364\(2006\)132:5\(533\)](https://doi.org/10.1061/(asce)0733-9364(2006)132:5(533))
- [5] Benjaoran, V., & Bhokha, S. (2010). An integrated safety management with construction management using 4D CAD model. *Safety Science*, 48, 395–403.
- [6] Bird, F. E., & Germain, G. L. (1990). No Title. *Practical Loss Control Leadership. International Loss Control Institute (Publ.), Revised Edition, 446pp.*
- [7] Carter, G., & Smith, S. D. (2006). Safety Hazard Identification on Construction Projects. *Journal of Construction Engineering and Management*, 132(2), 197–205. [https://doi.org/10.1061/\(asce\)0733-9364\(2006\)132:2\(197\)](https://doi.org/10.1061/(asce)0733-9364(2006)132:2(197))
- [8] Chai, J., Liu, J. N. K., & Ngai, E. W. T. (2013). Application of decision-making techniques in supplier selection: A systematic review of literature. *Expert Systems with Applications*, 40(10), 3872–3885. <https://doi.org/10.1016/j.eswa.2012.12.040>
- [9] Ciribini, A. L. C., Gottfried, A., Trani, M., & Bergamini, L. (2011). 4D modelling and construction health and safety planning. *Proceedings of the 6 International Structural Engineering and Construction Conference - Modern Methods and Advances in Structural Engineering and Construction (pp. 467-471), Zurich, Switzerland.*
- [10] Cooke, B., & Williams, P. (2009). *Cooke, B and Williams, P (2009) Construction Planning, Programming and Control 3rd Ed.* Blackwell, Oxford.
- [11] CPWR. (2013). The construction chart book, 5th Ed. In *CPWR—The Center for Construction Research and Training, Silver Spring, MD.*
- [12] Eastman, C. M., Jeong, Y.-S., Sacks, R., & Kaner, I. (2009). Exchange Model and Exchange Object Concepts for Implementation of National BIM Standards. *Journal of Computing in Civil Engineering*, 24(1), 25–34. [https://doi.org/10.1061/\(asce\)0887-3801\(2010\)24:1\(25\)](https://doi.org/10.1061/(asce)0887-3801(2010)24:1(25))
- [13] Furst, P. G. (2009). *Prevention through design (safety in design). Notes from a series of lectures at Harvard University.*
- [14] Giretti, A., Carbonari, A., Naticchia, B., & DeGrassi, M. (2009). Design and first development of an automated real-time safety management system for construction sites. *Journal of Civil Engineering and Management*, 15(4), 325–336.
- [15] Hadipriono, F. C., & Barsoum, A. S. (2002). Modeling for safety against falls from form scaffolding in a virtual environment. *Civil Engineering and Environmental Systems*, 19(2), 119–139.
- [16] Hinze, J. W., & Teizer, J. (2011). Visibility-related fatalities related to construction equipment. *Safety Science*, 49(5), 709–718. <https://doi.org/10.1016/j.ssci.2011.01.007>
- [17] Holický, M., Marková, J., & Šýkora, M. (2013). Forensic assessment of a bridge downfall using Bayesian networks. *Engineering Failure Analysis*, 30, 1–9. <https://doi.org/10.1016/j.engfailanal.2012.12.014>
- [18] Huang, X., & Hinze, J. (2006). Owner's Role in Construction Safety, (February), 164–173.
- [19] Imriyas, K., Pheng, L. S., & Lin, T. A. (2007). A decision support system for predicting accident risks in building projects. *Architectural Science Review*, 50(2), 149–162. <https://doi.org/10.3763/asre.2007.5021>
- [20] Jannadi, M. O., & Assaf, S. (1998). Safety assessment in the built environment of Saudi Arabia, 29.
- [21] Kim, S. E., Huang, H., Zhao, M., Zhang, X., Zhang, A., Semonov, M. V., ... He, X. (2013). Wnt stabilization of β -catenin reveals principles for morphogen receptor-scaffold assemblies. *Science*, 340(6134), 867–870. <https://doi.org/10.1126/science.1232389>
- [22] Ku, K., & Mills, T. (2010). Research needs for Building Information Modeling for construction safety. *Proceedings of the 47 th ASC Annual International Conference, Omaha, Nebraska.*
- [23] Langseth, H., & Portinale, L. (2007). Bayesian networks in reliability, 92, 92–108. <https://doi.org/10.1016/j.res.2005.11.037>
- [24] Lee, S. J., Kim, M. C., & Å, P. H. S. (2008). An analytical approach to quantitative effect estimation of operation advisory system based on human cognitive process using the Bayesian belief network, 93, 567–577. <https://doi.org/10.1016/j.res.2007.02.004>
- [25] Lew, J. J., & Lentz, T. J. (2010). Designing for safety – applications for the construction industry. *Proceedings of CIB W099 2010 (pp. 37-45), Salford, UK.*
- [26] McCabe, B., AbouRizk, S. M., & Goebel, R. (1998). Belief Networks for Construction Performance Diagnostics. *J Comput Civil Eng ASCE* 1998;12(2): 93–100.
- [27] Melzner, J., Zhang, S., Teizer, J., & Bargstädt, H. (n.d.). Construction Management and Economics A case study on automated safety compliance checking to assist fall protection design and planning in building information models A case study on automated safety compliance checking to assist fall protection design a, (July 2013), 37–41. <https://doi.org/10.1080/01446193.2013.780662>
- [28] Nasir, D., McCabe, B., & Hartono, L. (2003). Evaluating Risk in Construction—Schedule Model (ERIC—S): Construction Schedule Risk Model. *Journal of Construction Engineering and Management*, 129(5), 518–527. [https://doi.org/10.1061/\(asce\)0733-9364\(2003\)129:5\(518\)](https://doi.org/10.1061/(asce)0733-9364(2003)129:5(518))
- [29] OSHA. (2013). Occupational Safety and Health Administration. Diambil dari <https://www.osha.gov/SLTC/scaffolding/standards.html>
- [30] Osunsanmi, T. O., Aigbavboa, C., & Oke, A. (2018). Construction 4.0: The Future of the Construction Industry in South Africa. *International Journal of Civil and Environmental Engineering*, 12.
- [31] Prasetyo, M. G. (2009). Gambaran Tingkat Risiko Bahaya Keselamatan Pekerja Kontraktor yang Menggunakan Scaffolding pada Renovasi Gedung PAU di Universitas Indonesia Tahun 2009. *Fakultas Kesehatan Masyarakat Universitas Indonesia. Depok.*
- [32] Puerto, C. L., & Clevenger, C. M. C. (2010). Enhancing safety throughout construction using BIM/VDC. *Proceedings of the BIM-Related Academic Workshop, Washington D.C.*
- [33] Ratay, R. T. (1996). *Handbook of Temporary Structures in Construction.*
- [34] Safe Work Australia. (2012). *Comparison of Workers' Compensation Arrangement in Australia and New Zealand.*
- [35] Sahely, B. S. G. E., & Bagley, D. M. (2002). Diagnosing Upsets in Anaerobic Wastewater Treatment Using Bayesian Belief Networks. *Journal of Environmental Engineering*, 127(4), 302–310. [https://doi.org/10.1061/\(asce\)0733-9372\(2001\)127:4\(302\)](https://doi.org/10.1061/(asce)0733-9372(2001)127:4(302))
- [36] Sattineni, A. (2010). Real-time management in a BIM model with RFID and wireless tags. *Proceedings of the 18 th CIB World Building Congress - W078 (pp. 67-75), Cairo, Egypt.*
- [37] Suermann, P. C., & Issa, R. R. A. (2009). Evaluating industry perceptions of building information modeling (BIM) impact on construction. *Electronic Journal of Information Technology in Construction*, 14(August), 574–594. <https://doi.org/10.1038/onc.2011.590>
- [38] Sulankivi, K., Makela, T., & Kiviniemi, M. (2009). BIM-based site layout and safety planning. *Proceedings of CIB IDS 2009 – Improving construction and use through integrated design solutions (pp. 125-140), Helsinki University of Technology, Espoo, Finland.*
- [39] Tischer, T. E., & Kuprenas, J. A. (2003). Bridge Falsework Productivity- Measurement and Influences. *Journal of Construction Engineering and Management*, 129(3), 243–250.
- [40] Zhou, W., Whyte, J., & Sacks, R. (2011). Building safely by design: interim report. *DIRC Working Paper No. 2, Design Innovation Research Centre, University of Reading, UK.*

Shear Strength Parameter of MSW Embankment Due To Decomposition Process

1st Putera Muhammad Akmal

Civil and Environmental Engineering
Universitas Gadjah Mada
Indonesia

muhammad.akmal.putera@mail.ugm.ac.id

2nd Rifa'i Ahmad*

Civil and Environmental Engineering
Universitas Gadjah Mada
Indonesia

Corresponding Author
ahmad.rifai@ugm.ac.id

3rd Faris Fikri

Civil and Environmental Engineering
Universitas Gadjah Mada
Indonesia

fikri.faris@ugm.ac.id

Abstract— This research presents result of changes material of Municipal Solid Waste (MSW) embankments by decomposition process on engineering properties and shear strength parameters. It can be grouped by three cluster which has determined by ages of MSW. This research located on Piyungan MSW Embankment Yogyakarta. In situ test by standard penetration tests (SPT) and material sampling by test pit. The objective is to analyses the characterizations of engineering properties and shear strength parameter due to decomposition process. Engineering properties was determined by unit weight, water content, organic content and specific gravity. Also Shear strength parameter was determined by Triaxial test. Unit weight increased from the fresh embankment to the oldest embankment about 20.4%, also the results of shear strength parameter showed that cohesion value increased about 26.8% and the results of friction angles value increased about 9.8%. The due to decomposition process on MSW embankment which has the oldest embankment can be decomposed to improve engineering properties and shear strength parameter more than the fresh MSW embankment. Decomposition effects was indicated by organic content has been decreased about 35.6% from the fresh of MSW embankment to the oldest embankment. In accordance with the result of the laboratory analyses could be influence the slope stability analysis of waste embankment.

Keywords—Ages, Municipal Solid Waste, Decomposition, Shear strength parameter, engineering properties

I. INTRODUCTION

Municipal Solid Waste (MSW) embankment should be relevant in decomposition process of Engineering properties, it should be determined by total unit weight, water and organic matter content. Also decomposition process of shear strength parameter, it should be determined by cohesion and friction angle. However, there is a lot of difficulties to handling this research properly from the representative samples, and the lack of standardised procedures for insitu test and laboratories. This research presents the results of decomposition process of engineering properties and shear strength parameter to improve the MSW embankment at Piyungan MSW Embankment, Yogyakarta.

Yogyakarta is one of the big cities in Indonesia, and the waste collecting from various regions to Piyungan MSW Embankment. The composition of waste material in Piyungan are plastic waste mixed with organic materials from homes, market, grocery and hospital. Piyungan MSW Embankment was conducted by sanitary landfill. Piyungan MSW Embankment is the most widely-used method for

disposing of municipal solid waste in Yogyakarta Province since 1996 to recent. A data from 1996 to 1998, a reported the percentage of MSW increased from 63,938 ton to 143,204 ton. Also in 1999 to 2009 a data more fluctuating, it can described the data from difficulties of management system and limited resources. From 2010 to 2017 the data are shown in Fig. 1, it have to demonstrates the increased of total weight to recent.

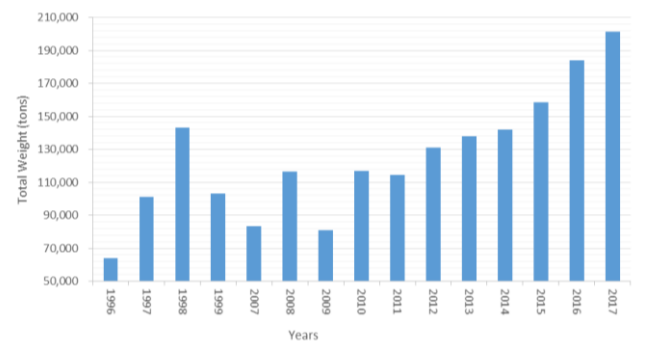

Fig. 1. Total Weight of MSW in Piyungan (1996-2017)

Piyungan MSW Embankment can be grouped by three cluster. The first cluster is the fresh MSW at top top embankment with elevation + 30 m from ground surface as reference (± 0.0 m). Second cluster is the middle ages of MSW which has 5 – 10 years old, located around at + 20 – 30 m of the height from the ground surface. The third cluster is the oldest MSW embankment which has more than 10 years old, located around at +10 – 20 m of the height from the ground surface.

From a many years data of waste management system in Piyungan MSW Embankment. The characterization of MSW is necessary to describe the constituents of the engineering response (e.i., compaction, compressibility, hydraulic conductivity and shear strength) at MSW Embankment (Cox, 2013). The objective of this paper is to analyses the characterizations of engineering properties and shear strength parameter due to decomposition process.

Study composition of MSW it can described a material MSW decomposition is a microbial mediated process that occurs in a series of sequential phases. Settlement in MSW Embankment was determined by mechanical processes whereas in the second phase there is a higher rate of settlement attributed to decomposition (McDougall, 2008).

It can related between rate of settlement and time of decomposition.

II. LITERATURE REVIEW

Interpreting the fundamental behaviour of landfilled waste is a unique engineering challenge. It requires the application of hydraulics, biochemistry and geomechanics to know a changed engineering properties by time period (McDougall, 2008).

A. Waste Components

Common categories of waste components consist of paper, plastics, food waste, metals, rubber and glass (McCaughey-Bell, Reinhart, Sfeir, & Ryan, 1997). In the Yogyakarta, the Piyungan MSW Embankment employs a classification system for the annual waste stream based on a weight basis. The detailed of weight based percentage by any disposed material in waste embankment in 2009 are presented in **Error! Reference source not found.** In Piyungan, domination of waste material from degradable is garden and bushes and non degradable material is plastic.

TABLE I. WASTE COMPONENTS MATERIAL IN PIYUNGAN MSW EMBANKMENT IN 2009 (SHIMIZU & BPPT, 2009)

Waste Component	Composition (%)
Degradable materials:	
· Food Waste	9.88
· Vegetables	7.22
· Fruits	12.2
· Garden and bushes	23.33
· Animal Food	3.36
· Etc	21.37
Sub Total	77.36
Non degradable materials:	
· Paper	5.65
· Plastic	9.96
· Wood	0.72
· Fabric	2.2
· Pamper	2.37
· Rubber	0.32
· Metal	0.19
· Glass	0.34
· Bone and Feather	0.72
· Etc	0.16
Sub Total	22.63
GRAND TOTAL	100

B. Unit Weight

Analyses of unit weight of MSW materials was determined by compaction effort and moisture content analyses. Lowest effort from compaction had a unit weight is about 3 kN/m³ and highest effort is about 17 kN/m³ (Zekkos, et al., 2006). The average result of compacted layer on 5 – 7.8 kN/m³, may proposed with good compacted process at 8,8 – 10,5 kN/m³ (Krase, 2008). Laboratory analyses from moisture content had a range value from 10% - 50%, it would be noticed from a composition in dry waste material and saturated waste material, which is consist of 50% in moisture content.

C. Shear Strength Parameter

The analyses of shear strength parameter in MSW materials able to analyses of slope stability in MSW embankments, shear strength parameter in waste material is best described by the Mohr-Coulomb failure criterion. These criterion be related to some value of axial strain, because the rage of displacement can be applied in shear devices varies, it is recommended that laboratories include a subscript to their strength parameters that indicates the displacement or axial strain can be determined MSW strength parameter (Stark, et. al., 2000).

The data of engineering properties and shear strength parameter due to the decomposition process there is large variability from many literature (Landva and Clark, 1986). The issues related to MSW such as the variation in its content in different regions, its heterogeneity, variable size of its components and its time-variant nature have added to the complexity of MSW (Shariatmadari et. al., 2013).

D. Organic Content

The organic content or loss on ignition of MSW material was deteremined in laboratory analyses by ASTM D2974 standard test methods for moisture, ash, and organic matter of peat and other organic soils. The organic content of MSW was determined by residue on ignition of waste materials at 525°C.

The specimens of waste material hae to subdivided into smaller portions. Next, the sub-specimens were then placed into porcelain bowls and weighed. After that the waste will on ignition and then transferred to dessicator to cool room temprature. Finally, the organic content of each subdivided waste material were determined by the averaging of the organic content.

III. RESEARCH METHOD

A. Research Location

The location of this research in Piyungan MSW Embankment, Ngablak, Sitimulyo, Piyungan Subdistrict, Bantul Regency of Yogyakarta Province can be seen in Fig. 2.

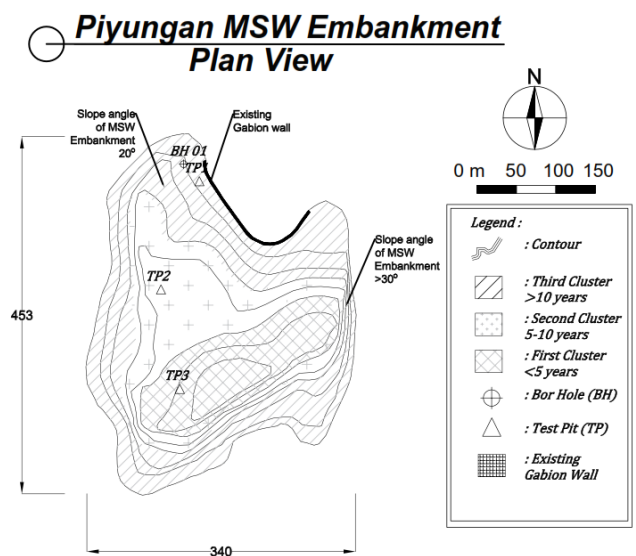

Fig. 2. Piyungan MSW embankment

B. Sampling

Samples were taken in disturbed condition considering the difficulties of undisturbed sampling on waste. Sampling was taken 3 points by test pit with depth of 1 – 1.5 m. Also 1 point by boring machine with depth 15 m from ground surface. Organic content would be analysed with grading into size range <20mm, it could be relevance of the selected material groups for a range of waste types with minimum component size it can be develop generic method for assessing degradation potential of component.

C. Triaxial Test for Shear Strength Parameter

Samples were tested by triaxial UU, triaxial testing on MSW material with and without fibrous waste (i.e., with and without material larger than 20 mm in dimension) (Bray et. al., 2008). Also Triaxial shearing may be representative of the field shearing mode of waste in case of the back calculation of failed waste slopes (Bray et. al., 2008). In this research the dimension of the sample is 70 mm with diameter 38 mm. On the other hand, many researcher has performed large scale test to provide compatibility about characterization of large size samples, recompacted and undisturbed sample analyses.

The shearing resistance of waste was determined by Mohr-Coulomb failure criteria used in soil mechanics, there is remain issues of the waste material, which is the strain cutoff to define failure criteria in 20%, required sample size, effect of anisotropy, the potential for different results between intact and recompacted samples (Fleming, 2008).

IV. RESULT ANALYSES

A. Organic Content

For each component of organic content samples to characterize the composition of fresh and old MSW materials. The varying layer of MSW embankment has been decreased organic contents from an initial value of 79.78%, 67.17% and 44.04% per test pit. It shows the biodegradable and highly deformable of component with different waste material has been decomposed by time. Differentiates between organic and inorganic components is degradable material and non-degradable material, the system of degradation does not consider about shape or material properties. The waste mechanics properties would be considered by selecting component such as shear strength, tensile strength, comprehensive strength, elongation at break (at given strain), and modulus of elasticity (Dixon, et al., 2008).

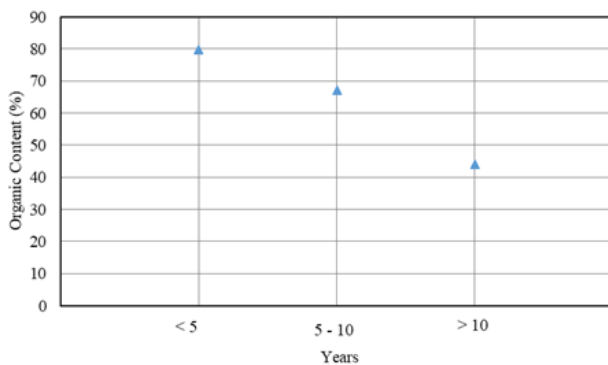

Fig. 3. The result of organic content with multiple years

B. Unit Weight

The Weighted-average based on water content of tested specimens of MSW materials was 101.7%. The degradable components represented approximately 79.78, 67.17 and 44.04% (by mass), of the entire incoming waste from residential, commercial and self delivered. In boring machine investigation, the material have been disturbed by sliding inside borehole, in which the cement suffered from loss in the injection process. The result of unit weight analyses can be seen in Fig. 4.

In the Fig. 4, the result of G_s analyses slightly increased, according with increasing depth was attributed to degradable material. The measures of the aging components of waste material are presented and, the decomposition process influenced the value of G_s from time to time.

In the Fig. 5, the result of unit weight analyses slightly increased, according with increasing depth was attributed to degradable material. The measures of the aging components of waste material are presented and, the decomposition process influenced the value of unit weight from time to time. The compacted layer by the fresh cluster with the result of analyses on unit weight, it would be described on average criterion by lower than good criterion at 0.8 gr/cm³ or 8.8 kN/m³. The compacted process need more concern properly on the field work.

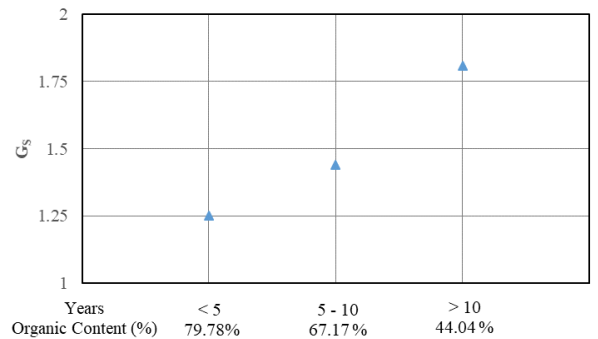

Fig. 4. The of result G_s analyses according to organic content with multiple years

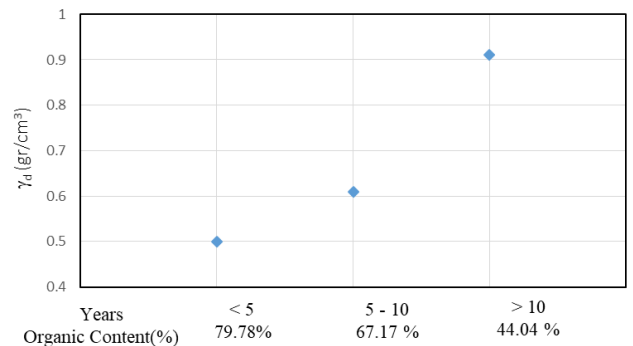

Fig. 5. The of result unit weight analyses according to organic content with multiple years

Determined the water contents of MSW materials obtained by drilling at varying distances from a bore hole. The varying depth of MSW material had increased water contents from an initial value of 63.46%, 108.04% and 133.6% per test pit. The water content of a typical MSW may

include both water held in macro or freely draining pores and water “absorbed” into micro-pores within individual waste components such as paper, cardboard, textiles, food etc. Water content will vary between its initial on collection and representing fully saturated conditions (Beaven et. al., 2008).

C. Shear Strength Parameter

The shear strength parameter mobilized at 17% was estimated as shown in Fig. 6 as axial strain. The difference in the shear strength envelopes is observed to be small, a unique shear strength can be represent the strength of both partially waste material specimens condition, in this condition shown the parameter of water content condition at 133.6% and the total unit weight 0.5 gr/cm³. In the Fig. 7 it was estimated axial strain at 16% with peak of deviatoric stress at >400 kN/m², in this condition the water content condition at 108.04% and the total unit weight 0.61 gr/cm³. Furthermore, the Fig. 8 was estimated axial strain at 17% with peak of deviatoric stress at >500 kN/m², in this condition the water content condition at 63.46% and the total unit weight 0.91 gr/cm³.

The increase of shear strength in the smaller samples can be in part credited to heterogeneity of the samples but the reinforcement effect of the fibrous materials may play an important role in this behavior since the same dimensions of fibrous material was used in both specimens (Bray et. al., 2008).

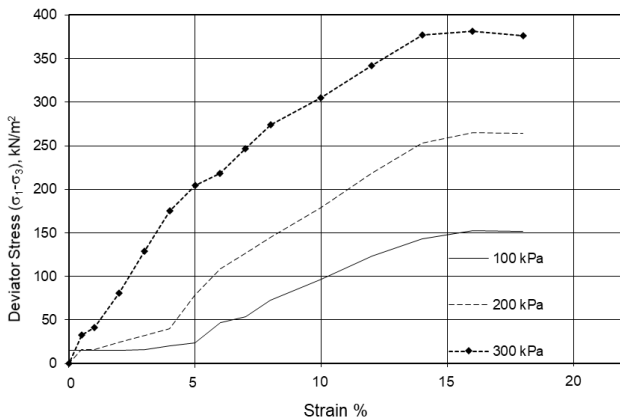

Fig. 6. Representative results from Triaxial UU on MSW material in < 5 years

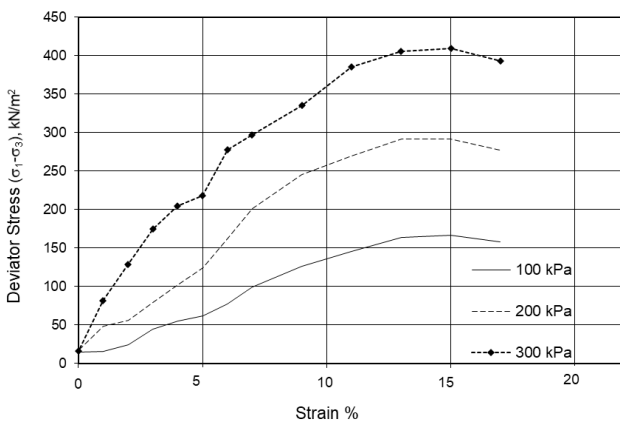

Fig. 7. Representative results from Triaxial UU on MSW material in 5 – 10 years

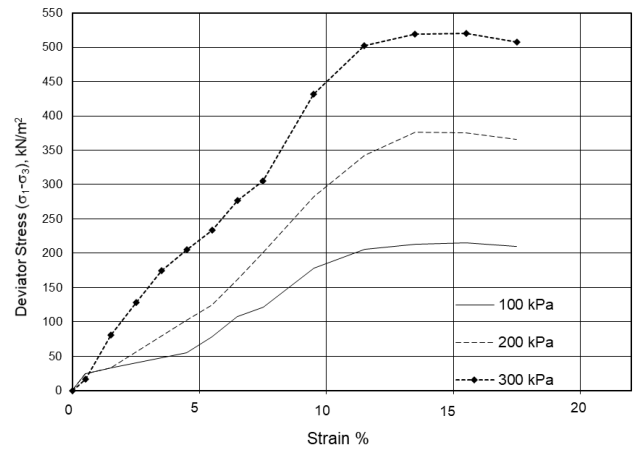

Fig. 8. Representative results from Triaxial UU on MSW material in > 10 years

The interpreted of cohesion and friction angle varied the layer of MSW embankment as shown in Fig. 9 and Fig. 10. Cohesion value has been increased because of the fibrous cohesion is generated by tensile stress in the fibrous materials and was found to depend on the normal stress (Bray et. al., 2008). With the fibrous material on non-degradable samples may give a friction on waste particles along with given an axial strain and deviatoric stress, because of The specimens with more fibrous are stronger than specimens with lower amounts of fibrous waste material when the shearing of the test specimen cuts across the long-axis of the larger fibrous waste particles.

The result of Triaxial UU test developed shear strength estimates of cohesion between 12.79 to 20.54 kPa along the decomposition process, the cohesion has been increased. Also the friction angle have a value from 21.35° to 25.66° due to decomposition process and the friction angle has been increased. Once researcher and practitioners agree on one or more consistent approaches for stress-deformation of MSW material should be directed toward the effect on the stress-deformation properties of degradation, aging, increased compaction etc (Fleming, 2008).

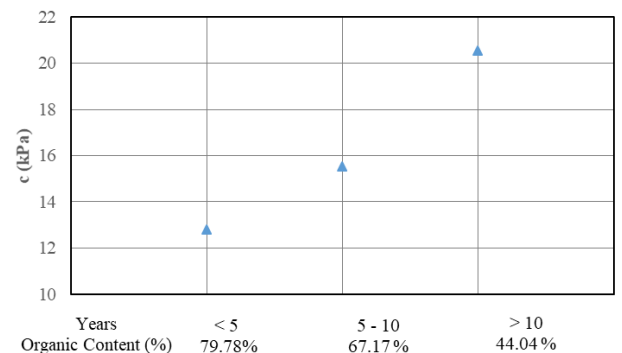

Fig. 9. The result of cohesion with varied years and organic contents

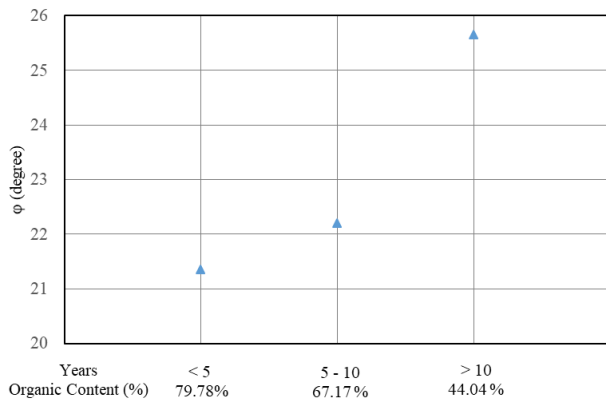

Fig. 10. The result of friction angle with varied years and organic contents

V. CONCLUSION

Based on the analyses that has been done, it can be concluded as follows. The result of the engineering properties of MSW embankment consisted of organic content that decreased from 79.78%, 67.17% and 44.04% due to decomposition process by time to time. The specific gravity has been increased from 1.25 to 1.81. Also the dry density increased slightly from 0.5 to 0.91 gr/cm³. With the fibrous and shape material from the non-degradables on samples may given a friction and cohesion on waste particles along with given an axial strain and deviatoric stress, it would be developed by Triaxial test. During the aging process of waste material the friction angle and cohesion parameter has been increased. By decomposition process of waste material, the oldest waste material more compacted from shear strength data rather than fresh waste material along with increasing of dry density by time to time.

Compacted process of waste material from embankment layers can be determined by dry density analyses due to decomposition process. From the fresh cluster it would be average results on compacted layer, it could be a recommendation to increased of proposed compacted layer in MSW embankment to protect the slope failures. In accordance with the result of the laboratory analyses could be influence the slope stability analysis of waste embankment.

ACKNOWLEDGMENT

The authors would like to thank NGS Grant (GRANT #HJ-129R-17 National Geographic Foundation for Science and Exploration – Asia), Government of Yogyakarta

Province (Balai PISAMP Dinas PUP-ESDM Pemda DIY) and UGM for all the support given to this study.

REFERENCES

Beaven, R. P., Powrie, W., & Zardava, K. "Hydraulic Properties of MSW," in Geotechnical Characterization, Field Measurement, and Laboratory Testing of Municipal Solid Waste, Proceedings of the 2008 International Symposium on Waste Mechanics. New Orleans, 2008: ASCE, pp. 1-43.

Bray, J. D., Zekkos, D., & Merry, S. M., "Shear Strength of Municipal Solid Waste," in Geotechnical Characterization, Field Measurement, and Laboratory Testing of Municipal Solid Waste, Proceedings of the 2008 International Symposium on Waste Mechanics. New Orleans, 2008: ASCE, pp. 44-75.

Cox, J. T., Effect of Waste Placement Practices on The Engineering Response of Municipal Solid Waste. San Luis Obispo: Department of Civil and Environmental Engineering, California Polytechnic State University, 2013.

Dixon, N., Langer, U., Reddy, K., Michele, M., Tinjum, J., Mahler, C., & Cho, Y., "Waste Characterization," in Geotechnical Characterization Field Measurement, and Laboratory Testing of Municipal Solid Waste, Proceedings of the 2008 International Symposium on Waste Mechanics. New Orleans, 2008: ASCE, pp. 135-155.

Fleming, I. R., "A Simple Index Value for Waste Mechanical Behaviour," in Geotechnical Characterization, Field Measurement, and Laboratory Testing of Municipal Solid Waste, Proceedings of the 2008 International Symposium on Waste Mechanics. New Orleans, 2008: ASCE, pp 218-223.

Krase, V., Stability of Municipal Solid Waste Landfills. Braunschweig: University of Braunschweig, Institute of Technology, 2008.

McCauley-Bell, P., Reinhart, D. R., Sfeir, H., & Ryan, B. O., Municipal Solid Waste Composition Studies. Practice Periodical of Hazardous, Toxic, and Radioactive Waste Management, vol. 4, pp. 158-163, October, 1997.

McDougall, J., Science and engineering of landfilled waste mechanics. Geotechnical Characterization, Field Measurement, and Laboratory Testing of Municipal Solid Waste, pp. 206-211, 2008.

Shariatmadari, N., Sadeghpour, A. H., & Razaghian, F., Effects of aging on shear strength behavior of municipal solid waste. International Journal of Civil Engineering, vol. 3, 226-237, 2013.

Shimizu, & BPPT., Laporan Akhir Proyek Utilitas TPST Piyungan Yogyakarta, 2009.

Stark, T. D., Eid, H. T., Evans, W. D., & Sherry, P. E., "Municipal Solid Waste Slope Failure. II : Stability Analyses," in J. Geotech. Geoenviron. Eng., vol. 126(5), pp. 408-419, 2000.

Zekkos, D., Bray, J. D., Jr., E. K., Matasovic, N., Rathje, E. M., Riemer, M. F., & Stokoe, K. H., "Unit Weight of Municipal Solid Waste," in J. Geotech. Geoenviron. Eng., vol. 132(10), pp. 1250-1261, 2006.

The Strength Characteristics of the Square and Circular Short and Long Column

1st Rahmani Kadarningsih
dept. of civil engineering
gorontalo state university
Gorontalo, Indonesia
rkadarningsih@ung.ac.id

2nd Rifadli Bahsuan
dept. of civil engineering
gorontalo state university
Gorontalo, Indonesia
rifadli@ung.ac.id

3rd Saiful Sultan Tanamas
dept. of civil engineering
gorontalo state university
Gorontalo, Indonesia
saifultanamas@yahoo.com

Abstract—*This The work of square column is considered easier than the work of circular column in terms of its implementation. The work is both on reinforcement assembly and during the framework making. However, the comparison of the strength of the two cross sections of the column still has to be proven. The analysis of the strength characteristic of reinforced concrete column using Pu Mu interaction diagram has been performed by Shet et al and Rabbany et al. The analysis of the strength characteristic column using Pu-Mu interaction diagram was carried out in order to compare the strengths of square and circular short column, as referred to SNI 2847: 2013. Based on the results of the analysis, it was found that the circular column produced greater nominal moment resistance than the square column with the same compressive force. The analysis of the effect of the slenderness on circular and square columns is also presented. The moment magnification factor as the effect of the slenderness in the square column consistently showed a smaller value compared to the circular column.*

Keywords—*square column, circular column, axial load moment interaction curve, slenderness column*

I. INTRODUCTION

Reinforced concrete column is a vertical compression element from the frame that resists the load of beam. The column is classified as a short column. If the column collapses, then it is due to the yielding of steel material or the failure of the concrete. The long column can collapse if there is loss of lateral stability due to buckling (Nawy 2009).

Circular section columns carry eccentric loads, ie loads that work on a particular eccentricity without distinguishing the x direction or the y direction. Square section columns divide loads into biaxial and uniaxial according to the location of the load on the x and y axes.

Columns are carried loads with a certain eccentricity which is equivalent to a structure carried in the combination of axial loads and bending moments. In a column section, the number of forces combination in receiving axial loads and bending moments is infinite. This strength of combination can be illustrated in the M-N interaction diagram.

In general, many building structures use square columns compared to circular columns. The difference in square columns and circular columns is, among others, the form of stirrups. The circular column has spiral stirrup and an adjacent stirrup distance, while the square column has a single cross stirrup and a relatively large distance between them.

The first objective of this research was to determine the comparison of the combination of axial load strength and bending moment of circular and square short columns with the

same cross-sectional area and number of reinforcement. The second objective was to compare the ratio of buckling effects on the circular and square length columns.

Interaction curve for C-shaped equal legged reinforced concrete column and rectangular column using ETABs software and analytical method by keeping constant area of steel and constant area of concrete in column has been discussed by Shet et al (2018). Ultimate Load-Moment capacities for C-shaped reinforced concrete column corresponding to orientation 1 and 2 depicts that C-shaped reinforced concrete column attains higher moment in carrying capacities than rectangular reinforced concrete column. Orientation 1 and 2 are the position of rectangular and C shaped equal legged reinforced concrete column with 0° and 90° degree (Shet et al. 2018).

Rabbany et al studied the changing pattern/behaviour of column load/moment/location which might help designer to predict the column performances in different conditions. The change of column load/column position also changes the column orientation neutral axis with a significant amount affecting the other values such as load, moment carrying capacity, etc. Different approaches give different values and column section which has different neutral axis distance (Rabbany et al. 2018).

Mohammed et al verified an experiment of 3D FEM called COM3D which was used to investigate the seismic performance of the circular shape and its equivalent square. RC columns with both cross-sectional shapes under varied axial load and web reinforcement are laterally pushed-over to fail in different modes. The analytical results showed a good agreement in seismic performance of both. As per the analytical results, the proposed approach was found satisfactory (Mohamed et al. 2013).

II. LITERATURE REVIEW

A. The Effect of Axial Load on Column Cross Section

The state of the axial load acting on the cross section of the column was divided into 2 types that are centric and eccentric loads. Column cross section with eccentric load can be divided into 4 types, those are compressive concrete conditions determination, balanced conditions, tension reinforcement conditions determination and eccentricity conditions which are very large, so that the axial loads are ignored.

The Column Section in Centric Load Conditions

Column cross section with centric load is a condition where the load works right on the longitudinal axis of the column. Therefore, both concrete and reinforcing steel carry out

compressive loads. Column cross section strength with a centric load was determined by assuming that all reinforcing steel has reached yielding and the concrete compressive strain has reached the maximum limit, $f_s=f_s'=f_y$ dan $\epsilon_c'=\epsilon_{cu}'=0,003$. Column cross section strength with centric load was calculated using the following equation [5,6]:

$$P_0 = 0,85f'_c (A_g - A_{st}) + A_{st}f_y \quad (1)$$

in which:

P_0 = column cross section strength with centric load (N)

f'_c = concrete compressive strength (MPa)

A_g = cross section gross area (mm²)

A_{st} = total reinforcement area (mm²)

f_y = steel yield stress (MPa)

The cross section of the column in compressive concrete conditions determination

The conditions at the cross section of the tensile area starts to hold the tensile load that relatively small, while the cross section of the compressive area holds a considerable compressive load. Therefore, the tensile reinforcement was not yield and compressed the concrete cracks. This is caused by a change in axial load from the condition of the centric load to the compressed area.

The distance between the neutral line and the compressive concrete edge (c) on the column cross section with the compressed concrete condition is relatively large, that is greater than the distance in balanced conditions (c_b). In compressive concrete conditions determination, the following requirements was applied (Asroni 2010, Sudarmoko 1996):

$$c > c_b \quad (2)$$

Column section in balanced condition

The tensile reinforcement strain reached yielding ($\epsilon_s = \epsilon_y$) at the compressive concrete strain which reached the cracking limit ($\epsilon_c' = \epsilon_{cu}' = 0.003$) at the balanced condition of the column cross section. The distance between the neutral line and the edge of the compressive concrete in this condition was determined as follows (Asroni 2010, Sudarmoko 1996):

$$\frac{c_b}{\epsilon_{cu}'} = \frac{d}{\epsilon_{cu}' + \epsilon_s} \quad (3)$$

in which $\epsilon_s = \epsilon_y = f_y/E_s$ or $\epsilon_s = f_y/200000$, and $\epsilon_{cu}' = 0.003$ it will be obtained:

$$c_b = \frac{600d}{600 + f_y} \quad (4)$$

in which:

c_b = the distance between the neutral line and the edge of the compressed concrete fibre at balanced cross-sectional condition (mm)

d = effective height of cross section of compressed concrete fibre to the centre of gravity of tensile reinforcement (mm)

ϵ_{cu}' = ultimate concrete compressive strain

ϵ_s = tensile strength of steel reinforcement

f_y = steel yield stress (MPa)

E_s = modulus of steel elasticity (MPa)

Column Cross Section in Tensile Reinforcement Conditions Determination

When the compressive concrete section condition is smaller, the concrete compressive strain is also smaller ($\epsilon_c' < 0,003$) and the value of c is also smaller, which is equal to:

$$c < c_b \quad (5)$$

The cross-sectional area of the tensile concrete will change larger, therefore the tensile reinforcement strain exceeds the yielding limit. Column cross section strength in this condition was determined by the tensile stresses of tensile reinforcement or fracture conditions (Asroni 2010, Sudarmoko 1996).

Column Cross Section Under Axial Load Conditions $P_n = 0$

Column cross section with axial load $P_n = 0$ only carry out the bending moment, therefore the column was analyzed like a normal beam (Asroni 2010, Sudarmoko 1996).

B. Column interaction diagram

The procedure to develop an interaction diagram was carried out by taking into account of the 5 types of load conditions in the column cross section as described above. The steps for creating a column interaction diagram are (Wijaya 2015):

1. Determining the material properties and column dimensions
2. Determining the distance between the neutral line and the compressed concrete edge (c)
3. Calculating the strain (ϵ_{si}), stress (f_{si}), internal force (F_{si}) and moment due to internal force (M_{si}) of each column longitudinal reinforcement according to the value of c taken using the following equation:

$$\epsilon_{si} = 0,003 \frac{(c - d_i)}{c} \quad (6)$$

$$\text{for } |\epsilon_{si}| < \frac{f_y}{E_s}, \text{ then } f_{si} = \epsilon_{si} E_s \quad (7)$$

$$\text{for } |\epsilon_{si}| \geq \frac{f_y}{E_s}, \text{ then } f_{si} = f_y \quad (8)$$

$$F_{si} = A_{si} f_{si} \quad (9)$$

$$M_{si} = F_{si} \left(\frac{h}{2} - d_i \right) \quad (10)$$

4. Calculating the internal force result of the longitudinal reinforcement column (C_s) and the total moment result of internal force (M_s)

$$C_s = \sum F_{si} \quad (11)$$

$$M_s = \sum M_{si} \quad (12)$$

5. Calculating the equivalent of compression zone (a)

$$a = \beta_1 c \quad (13)$$

- Calculating the internal force (C_c) and moment due to internal force (M_c) in the concrete compression zone

$$C_c = 0,85 f_c b a \quad (14)$$

$$M_c = C_c \frac{(h-a)}{2} \quad (15)$$

- Calculating the nominal axial force (P_n) and the nominal moment (M_n)

$$P_n = C_s + C_c \quad (16)$$

$$M_n = M_c + M_s \quad (17)$$

- Calculating the axial force of the design (P_u) and the strength moment design (M_u)

$$P_u = \phi P_n \quad (18)$$

$$M_u = \phi M_n \quad (19)$$

- Figuring the diagram of the interaction of axial force design and strength moments design

2.3 Slenderness effect

SNI 2847: 2013 requires the slenderness effect to be ignored if (BSN 2013):

- $\frac{kl_u}{r} < 34 - 12 \frac{M_{1b}}{M_{2b}}$, for compressed structural components that hold against the swing side
- $\frac{kl_u}{r} < 22$, for compressed structural components that do not hold against the swing side

with the effective length factor which is a function of the end support ψ_A and ψ_B for each upper and lower endpoints defined as::

$$\psi = \frac{\sum \left(\frac{EI}{l_u} \right)_{column-column}}{\sum \left(\frac{E_c I_{cr}}{l_n} \right)_{beam-beam}} \quad (20)$$

$$EI = \frac{E_c I_g}{2,5(1 + \beta_d)} \quad (21)$$

$$I_{cr} = \frac{I_{gb}}{2} \quad (22)$$

If the rate of slenderness exceeds the requirements, then two methods of stability analysis are used:

- Moment magnification method

This method of analysis is based on the magnification moment stated as:

$$M_c = \delta_b M_{2b} + \delta_s M_{2s} \quad (23)$$

with:

$$\delta_b = \frac{C_m}{1 - \frac{P_u}{\phi P_c}} \geq 1 \quad (24)$$

$$\delta_s = \frac{1}{1 - \frac{\sum P_u}{\phi \sum P_c}} \geq 1 \quad (25)$$

$$C_m = 0,6 + 0,4 \frac{M_{1b}}{M_{2b}} \geq 0,4 \quad (26)$$

$$P_c = \frac{\pi^2 EI}{(kl_u)^2} \quad (27)$$

- The analysis of the second order

The second order mathematical approach is needed if the slenderness number exceeds 100. In this analysis, the effect of deflection must be taken into account.

III. RESEARCH METHODE

This paper presents a comparison of the interaction diagram of axial loads and moments between circular and square short columns in theory investigation. In addition, analytical comparison of the effect of column length on circular and square columns is also presented. The short column and long column data used are as follows:

A. Material Properties

Material concrete properties and reinforcement are taken as follows:

$$f'_c = 30 \text{ MPa}$$

$$E_c = 23358.57 \text{ MPa}$$

$$\gamma = 24 \text{ kN/m}^3$$

$$\nu = 0.2$$

$$f_y = 240 \text{ MPa}$$

$$f_u = 370 \text{ MPa}$$

$$E_s = 200000 \text{ MPa}$$

B. Short Column Section Dimensions

The dimensions of the cross section of the short square and circular columns without calculating the slenderness effect are as follows (Tanamas 2010):

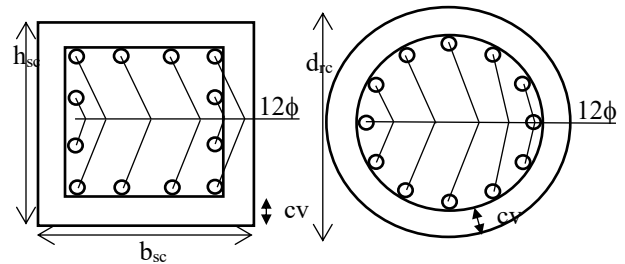

Fig. 1. The dimensions of the cross section of square and circular columns

Variations in the dimensions of circular and square columns are shown in Table I.

TABLE I. VARIATIONS IN THE DIMENSIONS OF CIRCULAR AND SQUARE COLUMN SECTIONS

Variation	Description	ρ of square column	ρ of circular column
-----------	-------------	-------------------------	---------------------------

1	Ag=90000 mm ² As=942 mm ²	S1.05%	C1.05%
2	Ag=90000 mm ² As=2413 mm ²	S2.68%	C2.68%
3	Ag=90000 mm ² As=3402 mm ²	S3.78%	C3.78%
4	Ag=160000 mm ² As=942 mm ²	S0.59%	C0.59%
5	Ag=160000 mm ² As=2413 mm ²	S1.51%	C1.51%
6	Ag=160000 mm ² As=3402 mm ²	S2.13%	C2.13%
7	Ag=250000 mm ² As=942 mm ²	S0.38%	C0.38%
8	Ag=250000 mm ² As=2413 mm ²	S0.97%	C0.97%
9	Ag=250000 mm ² As=3402 mm ²	S1.36%	C1.36%

The results of 3D structure analysis is based on the gravity and earthquake loads based on SNI 1726: 2012 in Yogyakarta. The analysis results of the structure on the central portal in the direction of XZ are shown in Table II-V.

TABLE II. THE ANALYSIS OF STRUCTURES DUE TO GRAVITY AND EARTHQUAKE LOADS IN COLUMNS E AND H

Internal Force	Gravity Load		Earthquake Load (E)
	Dead Load (D)	Live Load (L)	
Axial force (kN)	82.11	15.75	26.45
Moment (kNm): - Top of column	3.1	1.1882	22.3485
Moment (kNm): - Bottom of column	1.51	0.58	29.4258

TABLE III. THE ANALYSIS OF STRUCTURES DUE TO GRAVITY AND EARTHQUAKE LOADS IN COLUMNS F AND G

Internal Force	Gravity Load		Earthquake Load (E)
	Dead Load (D)	Live Load (L)	
Axial force (kN)	104.98	32.75	5.15
Moment (kNm): - Top of column	0.46	0.07	29.8862
Moment (kNm): - Bottom of column	0.224	0.0341	33.0994

C. Building the Prototype for Long Column Analysis

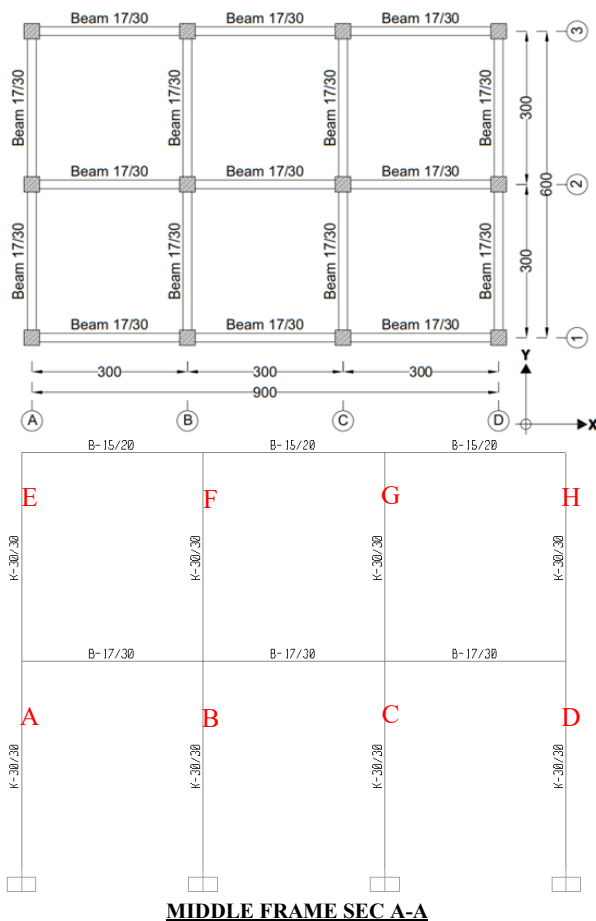

Fig. 2. Planning of the building for long column analysis

TABLE IV. THE ANALYSIS OF STRUCTURES DUE TO GRAVITY AND EARTHQUAKE LOADS IN COLUMNS A AND D

Internal Force	Gravity Load		Earthquake Load (E)
	Dead Load (D)	Live Load (L)	
Axial force (kN)	23.76	4.5	7.87
Moment (kNm): - Top of column	4.9491	1.3	12.5534
Moment (kNm): - Bottom of column	5.0341	1.59	7.8385

TABLE V. THE ANALYSIS OF STRUCTURES DUE TO GRAVITY AND EARTHQUAKE LOADS IN COLUMNS B AND C

Internal Force	Gravity Load		Earthquake Load (E)
	Dead Load (D)	Live Load (L)	
Axial force (kN)	41.92	9.07	1.24
Moment (kNm): - Top of column	0.5	0.0267	20.9375
Moment (kNm): - Bottom of column	0.6155	0.0358	17.7926

IV. RESULT AND DISCUSSION

A. Analysis of Column Cross Section Capacity Based on Interaction Diagram of Bending Moment and Axial Load

The results of the calculation of 9 circular and square column variations based on cross-sectional capacity on bending moment and axial load are shown in Fig. 3. The moment and axial load capacity is calculated based on the stress acting on the cross section of the reinforcement and the stressed cross section of the concrete. The area of the cross-

section of the compressed concrete is square in a square column, while the circular column is shaped a circle segment as high as a .

The interaction diagram of the entire column shows that the circular section column almost entirely produced a bending moment capacity and a greater axial load compared to the square section column. This is because in the same area, circular section column has a higher cross section so that it produced a wider compressed area. The arrangement of reinforcement in the circular column produced different moment arms so as to produce greater stress based on the elastic stress diagram. The form factor in circular cross section results in a larger area of compressive pressure. The larger area of the circle segment, the greater compressive stress will be produced which affects the cross-sectional capacity. These things cause greater bending moment capacity and circular column axial load than the square column.

The increase in the greatest moment capacity in the circular column against the square column occurs in the area of compressed concrete conditions from the interaction diagram. The increase of the capacity of the smallest moment on the circular column against the square column was the opposite in the tensile concrete condition area of the interaction diagram.

This is in accordance with the research conducted by Mohammed et al. who performed COM3D Lateral push over analysis which showed that at low value of the web reinforcement ratio, load capacity of circular column was less than the square column. In the same amount of main reinforcement, the increase of the web reinforcement ratio results higher load capacity of the circular column than the square column (Mohammed et al. 2013).

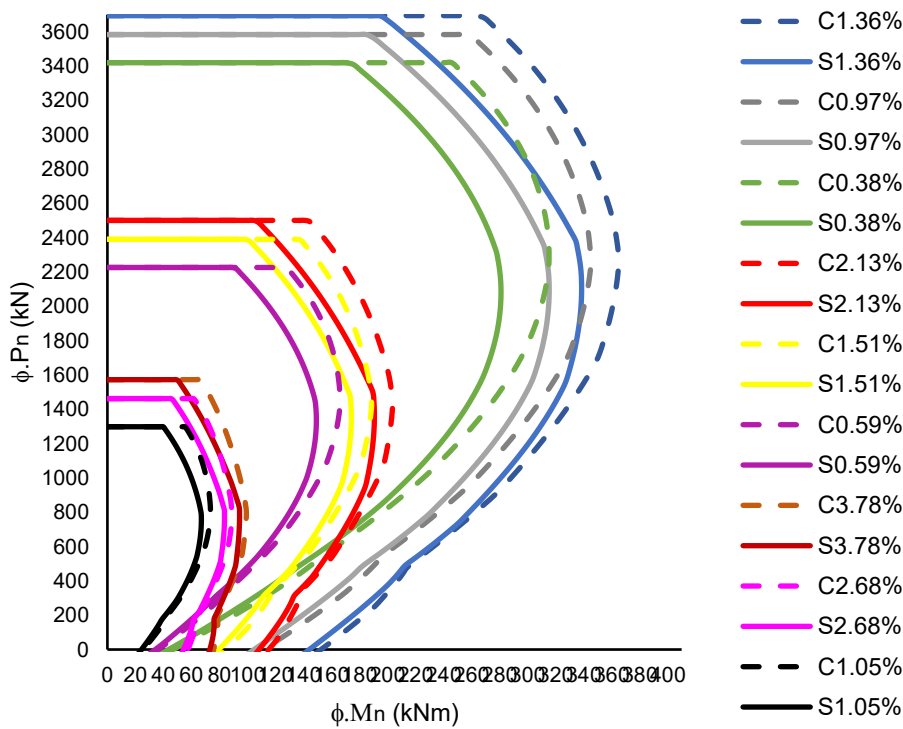

Fig. 3. Axial load-moment interaction curve circular and square column

B. The Analysis of the Effect of the Slenderness Effect on Circular and Square Columns

The calculation of the long square columns with taking into account the slenderness effect are as follows:

TABLE VI. THE CALCULATION OF THE LONG COLUMN SLENDERNESS EFFECT (δ_s) OF 300X300 DIMENSION SQUARE COLUMN WITH 3M LENGTH

Parameter Calculation	Column A2=D2	Column B2=C2	Column A1=A3=D1=D3	Column B1=B3=C1=C3
l_u	3 m	3 m	3 m	3 m
ψ_A	0.57	0.39	0.78	0.51
ψ_B	0	0	0	0

k	1.097	1.07	1.13	1.08
P_c	345941 kN	3298731 kN	2994999 kN	3191788 kN
P_u	140732 kN	163876 kN	98186 kN	104280 kN
δ_s	1.055946			

The slenderness factors in circular columns and square columns affect the magnitude of the magnification factor on the moment. The results of the calculation of moment magnification factors due to the slenderness of columns in circular and square columns did not show a significant difference. The moment magnification factor in a square column consistently showed a smaller value compared to a circular column. This value occurred both on the 1st and 2nd floors of building prototypes which are shown in Figs. 4 and 5.

The moment magnification factor in the square column consistently showed a smaller value compared to the circular column. This is because the euler buckling resistance at the moment of the square column cross section inertia was greater than the circular column. These factors showed that long rectangular columns were quite stable compared to circular length columns.

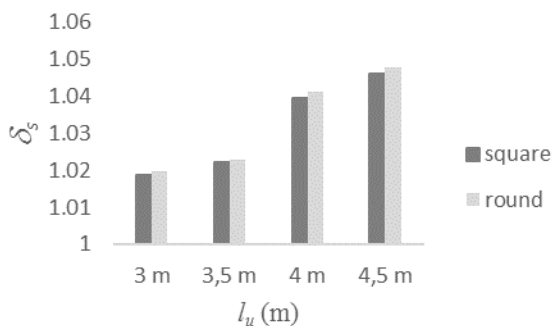

Fig. 4. Moment magnification factor on the 1st floor.

The moment magnification factor in the 1st floor column showed a greater value than in the 2nd floor column. This is because the amount of axial load acting on the 1st floor column was much greater than in the floor column 2. The effective long factor (k) was small and the large Euler buckling resistance (P_c) in the 1st floor column did not have much effect because of the large axial load.

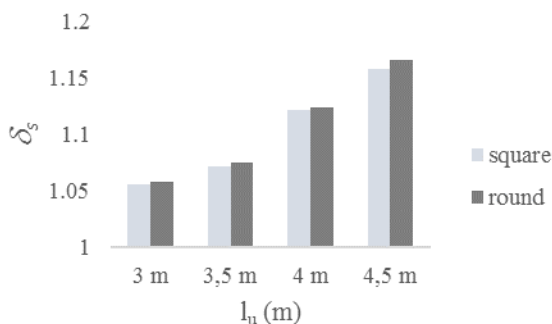

Fig. 5. Moment magnification factor on the 2nd

The moment magnification factor as a result of the column slenderness further was applied to axial load-moment interaction curve as shown in Fig. 6. The axial

load-moment interaction curve showed that the higher of the slenderness value according to the lower of the moment capacity. This is because the higher the value of the slenderness ratio according to the lower of the bending resistance of the euler and causes the higher moment magnification factor.

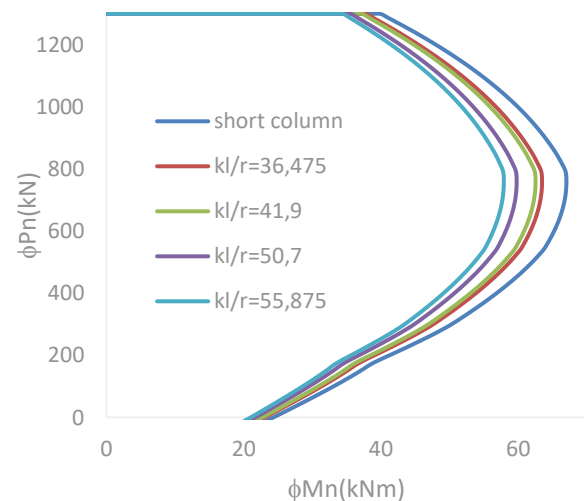

Fig. 6. Axial load-moment interaction curve circular and square column with slenderness effect

CONCLUSION

1. The interaction diagram of the entire column showed that the circular section column almost entirely produced a bending moment capacity and a greater axial load compared to the square section column.
2. Circular section column had higher cross section thus it produced a wider compressed area in the same area.
3. The arrangement of reinforcement in the circular column produced different moment arms thus it produced greater stress based on the elastic stress diagram.
4. The moment magnification factor in the square column consistently showed a smaller value compared to the circular column. This is because the euler buckling resistance at the moment of the square column cross section inertia which greater than the circular column.

REFERENCES

E. G. Nawy, *Reinforced concrete a fundamental approach* (Prentice Hall, Englewood Cliffs, 2009)

S. Shet, Sabyath Shetty, Shanmukha Shetty and R. M. Subrahmanya, *Strength characteristics of C-shaped equal legged RC columns and rectangular column using Pu-Mu interaction diagrams*, Int Jou of App Eng Research, 13(7), 6-11 (2018)

A. B. M. G. Rabbany, S. Islam, M. H. U. Zaman, *Short rcc column performance in different condition: axial, uniaxial and biaxial bending*, Int Jou of App Eng Research, 8(3), 70-85 (2018).

A. M. Y. Mohammed, A. Ahmed and K. Maekawa, *Seismic evaluation of rc column considering equivalency of circular and square cross sections*, Proc of East Asia-Pac Conf Struc Eng and Constr, Sept 11-13, 2013

Asroni, A, *Kolom, fondasi dan balok T beton bertulang* (Graha Ilmu, Yogyakarta, 2010)

Sudarmoko, *Perancangan dan analisis kolom beton bertulang*, (Biro Penerbit KMTS FT UGM, Yogyakarta, 1996)

Wijaya, M, *Retrofitting of reinforced concrete interior beam column joint using polyester resin concrete*, Master diss., Universitas Gadjah Mada, 2015

BSN, SNI 2847 :2013 *Persyaratan beton struktural untuk bangunan gedung* (Departemen Pekerjaan Umum, Yayasan LPMB, Bandung)

Tanamas, S. S, *Perbandingan Kekuatan Kolom Berpenampang Persegi dan Bulat*, Tugas Akhir, Universitas Negeri Gorontalo, 2010

GFRP as an Alternative to Steel for Sustainable Reinforced Concrete

1st Rezky Aprilyanto Wibowo
Sepuluh Nopember Institute of Technology (ITS)
Surabaya, Indonesia
rezkyapriyanto@gmail.com

Abstract—Corrosion of steel in Reinforced Concrete (RC) can compromise the structural integrity and cost billions of dollars every year. To reduce these impacts, finding the new, sustainable, eco-friendly, and cost-efficient construction materials has a significant impact in improving the sustainability of buildings and economic increase. To meet the above mentioned requirements, this literature review aims to examine the feasibility and sustainability of Glass Fiber Reinforcement Polymer (GFRP) bars as an alternative to steel in reinforced concrete. The method used is a Systematic Literature Review (SLR) of 29 relevant international journals from 2009 to 2019. The results show that GFRP-RC can be used as cost-effective solution to steel corrosion and sustainable alternative to steel due to the least amount of CO₂ production rather than other types of Fiber Reinforcement Polymer. But the strength and durability as a feasible option for RC structures still remain controversial. Recently, significant improvement found in the prediction of deflection and stiffness of the beams. GFRP bars used as longitudinal reinforcement can resist compressive stresses in excess of 700 MPa and GFRP lateral reinforcement can confine concrete core more effectively than steel. Recommendations for future implementation include establishing building codes, improving recyclability and lowering initial costs

Keywords—glass fiber reinforcement polymer; steel; corrosion; sustainability; reinforced concrete.

I. INTRODUCTION

Conventional steel bar is usually used as structural concrete reinforcement. However, the corrosion of internal reinforcing steel is the main cause of infrastructure deterioration among reinforced concrete structures worldwide (Sheikh SA, 2018) and cost billions of dollars every year (Barker C, 2016). The steel corrosion is reducing the lifespan of these structures and causes cracking and spalling of concrete with consequent need of expensive retrofitting (D'Antino T, 2018).

During the last decade, FRP reinforcing bars as one of the most effective alternative solutions have been increasingly used to overcome durability problems of traditional steel reinforcement and used as the main reinforcement for concrete structures in harsh environments (Alves J, 2011). The three most FRPs' fibres widely used are carbon, glass, and aramid fiber reinforced polymers (CFRP, GFRP, and AFRP) (Barker C, 2016). Each type of fibre provides a solution to the problems associated with steel, but it is important to find which type of FRP as an alternative to steel in reinforced concrete which is most feasible, eco-friendly, cost-efficient, and particularly sustainable to improve the sustainability of buildings and economic increase.

In recent years, Glass Fibre Reinforced Polymer (GFRP) sheets application in the repair and rehabilitation of concrete structures has grown significantly. Among all types of FRPs, GFR bars present a feasible and cost-efficient solution to the problem of steel corrosion and can be used as a viable reinforcement alternative for traditional steel reinforcing bars. However, GFRP has properties that are very different than steel that make it presents its own challenges and the application of GFRP to replace steel is still not be accepted by most designers. The primary reason is because comparing with conventional steel-reinforced structures, GFRP still has a lack of data and analytical procedures (Sheikh SA, et al., 2018). To figure out the problem of GFRP application, it is important to create a better understanding of the overall behavior of GFRP as internal reinforcement, especially about the feasibility in strength and durability, and also in the field of its sustainability. This literature review aims to examine the feasibility and sustainability of Glass Fiber Reinforcement Polymer (GFRP) bars as an alternative to steel in reinforced concrete.

II. LITERATURE REVIEW

A. Glass Fiber-Reinforced Polymer (GFRP)

Fibre reinforced polymer (FRP) materials have been increasingly considered as an alternative replacement to traditional materials for applications in civil engineering structural due to their high strength, low self-weight, ease of installation, electromagnetic transparency and good chemical and corrosion resistance (Carbal, 2012). These materials can be used as an alternative for the development of more durable and sustainable structures with the low maintenance requirements. GFRP bars were selected because it provides electrical insulation in the rail bed (ACI, 2015). It has significant benefit of providing long-term service due to its corrosion resistance, particularly in highly corrosive environments, such as seawalls and other marine structures, bridge decks and superstructures exposed to deicing salts, and pavements treated with deicing salts that are especially vulnerable (Mara, 2014).

B. Sustainability

The construction industry is one of the most energy-intensive production sectors which is responsible for a great share of total carbon emissions, and waste generation (D'Amico, 2018). In many different engineering fields, sustainable development has become an increasingly important issue and construction industry is being pressured to contribute in sustainable development (Zhang, 2011). Sustainable design and construction focus on minimization

of the environmental impact, not only on the the initial cost but the cost over the entire life of structures (Mara, 2014).

In order to examine whether the use of GFRP RC contributes to sustainable development, the discussion of the GFRP RC use focuses on these three aspects of sustainability; the social development, environmental protection, and economic feasibility and development (Hernández-Moreno, 2015). Today, innovative technologies should be developed in an attempt to balance these aspects, i.e. to support human well-being by reducing risks and enhancing cost effectiveness and environmental benefits.

III. METHODOLOGY

The scope of this research is to investigate the use of Glass Fiber Reinforcement Polymer (GFRP) as alternative sustainable materials to confront the challenges and issues of steel corrosiveness that can compromises the structural integrity of reinforced concrete (RC) structures in construction. A wide variety of sources are available on Glass Fiber Reinforcement Polymer (GFRP) topics, including journal articles, conference proceedings papers, reports, and thesis. Only peer-reviewed articles are included to ensure the academic standard of the literature analyzed in this study. In the literature review, 20 publications, from 2009 to present, have been studied.

A. Research Question

Research Questions are made based on the needs of the chosen topic. The following are the research questions in this study:

- Is Glass Fiber Reinforced Plastic (GFRP) used in the world of the construction industry?
- Does Glass Fiber Reinforced Plastic (GFRP) have advantages over conventional construction materials such as steel?
- Does Glass Fiber Reinforced Plastic (GFRP) have the capability as a sustainable material?

B. Search Process

The search process is used to obtain relevant sources to answer the Research Question (RQ) and other related references. The search process is done by using a search engine (Google Chrome) with the site address <https://ascelibrary.org/>, <https://www.sciencedirect.com/>, <https://ieeexplore.ieee.org/>, and <https://www.tandfonline.com/> for primary data.

TABLE I. JOURNAL QUALITY LEVEL OF SELECTED STUDIES

No	Journal Publications	SJR	Q Category
1.	Journal of Composites for Construction (ASCE)	1.84	Q1 in Building and Construction
2.	Journal of Materials in Civil Engineering (ASCE)	1.03	Q1 in Building and Construction
3.	Composite Structures (Elsevier)	1.91	Q1 in Ceramics and Composites
4.	Composites Part B: Engineering (Elsevier)	2.04	Q1 in Ceramics and Composites
5.	Construction and Building Materials (Elsevier)	1.61	Q1 in Building and Construction
6.	Engineering Structures (Elsevier)	1.69	Q1 in Civil and Structural Engineering

7.	Plastics, Rubber and Composites (Money and Publishing)	0.25	Q3 in Ceramics and Composites
8.	Advanced Composite Materials (Taylor and Francis)	0.5	Q2 in Ceramics and Composites
9.	Journal of Earthquake Engineering (Taylor and Francis)	0.93	Q1 in Building and Construction

C. Studies_Selection Strategy

- Publication Year : 2009-2019
- Publication Type : Journal and Conference Proceedings, Reports, and Thesis
- Search String : GFRP, Sustainable Materials, Industry Construction, Reinforced
- Concrete, Fiber Reinforcement Polymer (FRP)
- Selected Studies : 20

D. Quality Assessment

In SLR research, data found will be evaluated based on question of quality assessment criteria as follow :

- QA1. Is the journal paper used in the 2009-2018 period?
- QA2. Did the journal write about using GFRP?
- QA3. Does the journal paper write GFRP as an alternative to steel or sustainable material?
- QA4. Does the journal write down the benefits of using GFRP?

The questions were scored as follows:

- QA1 : Y (yes), the inclusion criteria are explicitly defined in the study, N (no), the inclusion criteria are not defined and cannot be readily inferred
- QA2 : Y, if the journal writes about the use of GFRP directly, N if the journal is not mentioned using GFRP
- QA3 : Y, if the journal writes about the use of GFRP directly as a steel substitute material or sustainable material, N if the journal uses GFRP is not mentioned as an alternative to steel or as a sustainable material
- QA4: Y, if the journal explains the benefits of using GFRP, N if the journal does not mention the benefits

The scoring procedure was Y = 1, N = 0, or Unknown (i.e. the information is not specified) if the score is 3 or more than 3 then accepted.

IV. RESULT AND ANALYSIS

In any constructed asset, the aspects that integrate to sustainability are the social, environmental, and economic aspects (Hernández-Moreno, 2015). This paper reviewed all aspects that fully integrated with sustainability in construction project in term of GFRP use.

A. Sustainability from Social Aspects

Based on the framework of PANTURA project (Thodesen C, 2012), the indicators for social impact are work-zone safety on site, user’s convenience, and noise and dust emissions (Mara, 2014). In term of worker safety based on research conducted by Knippers et. al. (2010), the use of GFRP has several advantages, such as ease of handling and a reduced need for heavy equipment which can enhance safety for workers on site (Knippers, 2010). User’s convenience also the important part to determined the social aspect.

User convenience can be disturbed due to traffic restriction which is caused by the replacement of existing bridges due to the maintenance of concrete decks deterioration. The replacement process are also the pronounced problems to lengthy traffic delays and considered as one of the most common problems in existing composite (steel concrete) bridges. The application of GFRP composite bridge decks offer the benefit in improving the user’s convenience. Due to light weight of GFRP compared to conventional concrete, it has potential weight-saving benefits that leads to faster transportation, rapid on-site assembly, and less traffic disturbance and restrictions. Less delay in traffic during construction increases the comfort of users and their value of time. By using GFRP, the construction time can be accelerated and it generates to the minimization of traffic disturbance and restrictions. The number of pedestrian and traffic accidents also can be minimized by reducing the traffic restrictions around the project site such as detours and the total construction time (Mara, 2014). Besides that, its decking system enables swift installation due to light and prefabricated nature that makes the possession time and minimized the disruption to traffic. The bridge substructure will also be capable of taking more live loads because the reduced weight of the superstructure (Zhang, 2011).

Society’s welfare is also the one of social impact indicator, and it is closely related noise and dust emissions. Reducing the intensity of noise and vibrations can increase the society’s welfare. It can be achieved through GFRP bridge deck installations due to the use of light lifting equipment on site and rapid erection. The prefabrication of GFRP decks and the nature of the GFRP material also minimize dust emissions. The dust emitted from concrete decks during the on-site assembly somewhat higher in comparison with GFRP decks (Mara, 2014).

B. Sustainability from Environmental Aspects

1) Energy Consumption

Glass Fibre Reinforced Polymer (GFRP) decks require substantially lower energy consumption compared with carbon fibres (Fig. 1). Indeed, concrete has less embodied energy consumption compared to GFRP materials, but it should be noted that while evaluating the environmental impact of a material, the quantity and the functions of the materials need to be available. Therefore, the quantity of GFRP material used for a bridge deck is less than that for a concrete deck and make it has less environmental impact compared to concrete material (Mara, 2014).

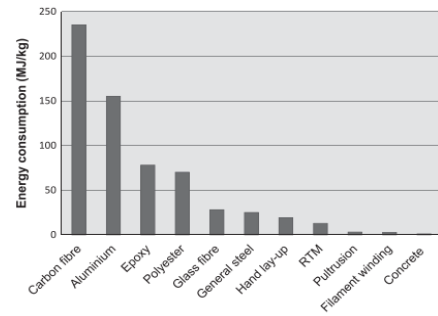

Fig. 1. Energy consumption for production of different materials and manufacturing process (Hammond, 2008)

Based on Daniel’s research, GFRP requires less than half of the energy input that is required for an equivalent project constructed using steel, stainless steel, aluminium or concrete (Daniel, 2010). Another study (Resins, 2009) confirm that GFRP materials used in bridge superstructure can saving energy consumption compared with traditional materials, such as steel and concrete (see Fig 2).

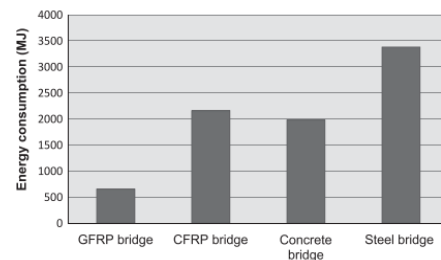

Fig. 2. Comparison of energy consumption of a road bridge composed of various material options (Resins, 2009)

2) Carbon Emissions

Research from Zhang et al. (2011) showed that during the deck replacement stage, traffic diversions contributed significantly to carbon emissions. The shorter construction period leading to less traffic diversion related carbon emissions, causing FRP as a superior option due to its faster installation and thereby fewer traffic diversions than the concrete deck option (Zhang, 2011). The light weight of FRP material caused the reduction in material needed for the substructure of footbridge and also to the transportation method used for FRP elements, both of them contribute to the carbon emission savings. Compared with a pre-stressed concrete (PC) footbridge, carbon emissions of an FRP footbridge can be reduced by 26% (Mara, 2014). Study from Resins (2009) showed that the carbon emissions were reduced by 48% for a 12 m long road bridge composed of a GFRP composite superstructure compared with a concrete bridge (see Fig. 3).

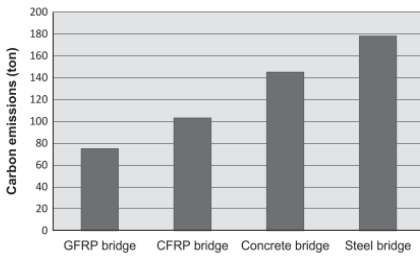

Fig. 3. Comparison of carbon emissions for four bridges composed of different materials (Resins, 2009; Mara, 2014).

3) Water and Air Pollution

Environmental pollution is not only measured by the carbon emissions but also measured by the water and air pollution. Daniel (2010) compared water and air pollution generated during the production of GFRP components to that obtained with other materials, such as structural steel, aluminium and reinforced concrete. In terms of water, the loads to air in the composite bridge is the second “cleanest” option after the steel bridge (see Table 4), while in terms of loads to water, the composite bridge is the undisputable winner (see Table 5). The results show that the composite bridge is the best in terms of the resulting water and air pollution levels (see Fig. 6). The structural steel bridge is the second, concrete bridge is the third and aluminium bridge is the fourth (Daniel, 2010). The pie charts (right) in Fig. 4. showed the comparison of the total critical volumes of polluted air and water. The composite bridge appears to be more favorable than the other considered options.

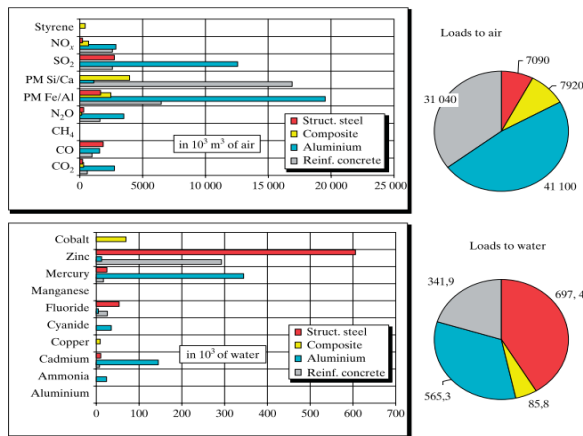

Fig. 4. Polluted air and water as a result of bridge construction with four material options (Daniel, 2010)

4) Waste Management

Environmental sustainability also determined by the management of waste. The potential sustainable method for FRP waste management is by incineration of composites with energy recovery. Composite materials are useful as energy carriers for heating or electricity because they release a large amount of energy in controlled incineration. The remains after incineration are glass fibres which can be used for manufacturing glass wool. Even though dealing with FRP waste has many different sustainable ways, but they are still not in regular use, this led to the landfill method as a common general solution for managing FRP waste (Mara, 2014).

TABLE III. TYPE STYLES EMISSIONS TO AIR STRUCTURAL STEEL, COMPOSITE, ALUMINIUM AND REINFORCED CONCRETE

Polluter	Structural steel $B_{st,i}$	Composite $B_{cp,i}$	Aluminium $B_{al,i}$	Concrete $B_{cr,i}$	Threshold $B_{th,i}$
CO ₂	$2,56 \times 10^{-3}$	$1,03 \times 10^{-3}$	$2,1 \times 10^{-4}$	$4,95 \times 10^{-2}$	9×10^{-3}
CO	$9,58 \times 10^{-1}$	1,32	$5,15 \times 10^{-1}$	3,48	4×10^{-5}
CH ₄	5,95	1,21	$5,39 \times 10^{-1}$	$9,89 \times 10^{-1}$	$6,7 \times 10^{-3}$
N ₂ O	$3,7 \times 10^{-2}$	$4,8 \times 10^{-3}$	$2,94 \times 10^{-1}$	$1,51 \times 10^{-2}$	1×10^{-7}
PM Fe/Al-oxi.*	$2,2 \times 10^{-1}$	$1,05 \times 10^{-1}$	1,65	6×10^{-2}	1×10^{-7}
PM Si/Ca-oxi.*	$4,2 \times 10^{-2}$	$5,05 \times 10^{-1}$	$2,7 \times 10^{-1}$	$4,7 \times 10^{-1}$	3×10^{-7}
SO ₂	3,28	$2,51 \times 10^{-3}$	$1,27 \times 10^{-1}$	$2,8 \times 10^{-1}$	$1,2 \times 10^{-6}$
NO ₂	3,08	2,83	$2,45 \times 10^{-1}$	1,27	1×10^{-5}
Styrene	-	$1,2 \times 10^{-1}$	-	-	8×10^{-7}

*PM = particulate matter (dust), here predominately Fe/Al or Si/Ca oxides.

TABLE IV. TYPE STYLES EMISSIONS TO AIR STRUCTURAL STEEL, COMPOSITE, ALUMINIUM AND REINFORCED CONCRETE

Polluter	Structural steel $B_{st,i}$	Composite $B_{cp,i}$	Aluminium $B_{al,i}$	Concrete $B_{cr,i}$	Threshold $B_{th,i}$
Aluminium	$3,33 \times 10^{-6}$	2×10^{-6}	$3,09 \times 10^{-5}$	$1,65 \times 10^{-7}$	5×10^{-5}
Ammonia	$4,58 \times 10^{-3}$	$1,1 \times 10^{-3}$	$4,23 \times 10^{-2}$	$2,38 \times 10^{-4}$	$2,2 \times 10^{-3}$
Cadmium	$4,57 \times 10^{-5}$	$2,1 \times 10^{-6}$	$4,28 \times 10^{-4}$	$2,18 \times 10^{-6}$	$3,5 \times 10^{-6}$
Copper	$1,96 \times 10^{-8}$	$7,9 \times 10^{-4}$	$1,82 \times 10^{-7}$	$0,99 \times 10^{-9}$	2×10^{-4}
Cyanide	$3,08 \times 10^{-4}$	$7,04 \times 10^{-5}$	$2,85 \times 10^{-3}$	$1,6 \times 10^{-5}$	1×10^{-4}
Fluoride	$1,03 \times 10^{-1}$	2×10^{-4}	$6,49 \times 10^{-3}$	$3,51 \times 10^{-3}$	$1,5 \times 10^{-3}$
Manganese	$6,07 \times 10^{-6}$	$3,6 \times 10^{-6}$	$5,64 \times 10^{-5}$	$3,03 \times 10^{-7}$	5×10^{-5}
Mercury	$1,57 \times 10^{-4}$	7×10^{-7}	$1,45 \times 10^{-3}$	$7,53 \times 10^{-6}$	5×10^{-6}
Zinc	3,97	$1,4 \times 10^{-3}$	$5,44 \times 10^{-2}$	$1,35 \times 10^{-1}$	5×10^{-3}
Cobalt	-	3×10^{-2}	-	-	1×10^{-3}

C. Sustainability from Economic Aspects

Even though composites have many benefits in term of energy consumptions, less carbon emissions, water and air pollution that make composites an advantageous material for bridges, but construction costs are slightly higher. The choice of what type of material used is depend on these considerations; if the primary concern was on construction cost, the best choice is a structural steel bridge. But if the concern is mainly on environment to reach the sustainability with a little extra cost was acceptable, the best choice is to use the composite bridge of pultruded profiles (Daniel, 2010).

GFRP bars are more attractive to the construction industry because of their lower cost compared with other types of FRP bars, especially for implementation in bridge deck slabs (Alves, 2011). Fiber-reinforced polymer bars have one-sixth to one-fourth that of steel density ranging from 77.8 to 131.0 lb/ft³ (1.25 to 2.1 g/cm³), (Table II). This reduced weight beneficial for lowers transportation costs and eases handling of the bars on the project site (ACI, 2015).

TABLE II. TYPICAL DENSITIES OF REINFORCING BARS, LB/FT³ (G/CM³)

Steel	GFRP
493.00	77.8 to 131.00
(7.90)	(1.25 to 2.10)

Source: ACI, 2015

Another research showed the cost saving potentials of the FRP decking system are currently increasing (Zhang and Canning 2011). Despite the FRP decking system has higher initial material cost, but its high durability makes the maintenance costs over its service life will be minimized, so their use may provide more cost-effective solutions over the life cycle of the structure due to reduced maintenance costs (Canning and Luke, 2010).

D. Strength and Durability

The strength and durability as a feasible option for RC structures still remain controversial. Recently, significant improvement found in the prediction of deflection and stiffness of the beams. A systematic investigation was carried out by Sheikh et. al. (2018) to determine the influence of concrete strength, GFRP transverse reinforcement and longitudinal reinforcement stiffness on the behavior of beams in flexure and shear. GFRP bars in monotonic compression used as longitudinal reinforcement can resist compressive stresses in excess of 700 MPa, about 60% of the tensile strength of the bar. It is found that columns reinforced with steel longitudinal bars and confined with GFRP spirals have similar to or better than columns confined with steel spirals in term of its overall strength and ductility. GFRP spirals have capability in providing effective confinement until a strain of about 2% that leading to the delaying crushing of the column core. Meanwhile, confinement with steel in columns deteriorates rapidly after yielding of steel. In seismic and non-seismic regions, as the primary lateral reinforcement is suggested to use GFRP spirals. the use of longitudinal steel bars and GFRP transverse reinforcement is an optimum solution against corrosion of reinforcement in columns (Sheikh, 2018).

V. CONCLUSION

The use of GFRP has some advantages in term of sustainability to be used as an alternative to steel for sustainable reinforced concrete. In social aspect, the use of GFRP enhance safety for workers on site, reduce the traffic restrictions, minimization the lengthy traffic delays that lead to interfere the user's convenience and accelerating the construction process, and also reduce the intensity of noise and vibrations to increase the society's welfare. In environment aspects, analysis of the energy consumption makes the GFRP elements as the most interesting material option due to its least energy consuming compared to concrete material and contributed in carbon emission savings. The composite bridge is also the best in terms of the resulting water and air pollution levels.

GFRP bars are still more attractive to the construction industry because of their lower cost compared with other types of FRP bars. Their better potential durability provides more cost-effective solutions due to reduced maintenance costs and longer service life. In term of its strength and durability, GFRP bars used as longitudinal reinforcement can resist compressive stresses in excess of 700 MPa. It can be used as an optimum solution against corrosion of reinforcement in columns.

VI. RECOMMENDATION

Recommendations for future implementation include establishing building codes, improving recyclability and lowering initial costs

REFERENCES

- ACI 440.1R-15. (2015). Guide for the Design and Construction of Structural Concrete Reinforced with Fiber-Reinforced Polymer (FRP) Bars. Farmington Hills USA: American Concrete Institute.
- Alves, J., El-Ragaby, A., & El-Salakawy, E. (2011). Durability of GFRP Bars' Bond to Concrete under Different Loading and Environmental Conditions. *Journal of Composites for Construction*, 15(3), 249–262. [https://doi.org/10.1061/\(asce\)cc.1943-5614.0000161](https://doi.org/10.1061/(asce)cc.1943-5614.0000161)
- Barker, C. (2016). The Feasibility of Fibre Reinforced Polymers as an Alternative to Steel in Reinforced Concrete. McGill University. http://digitool.Library.McGill.CA:80/R/-?func=dbin-jump-full&object_id=144637&silolibrary=GEN01
- Cabral-Fonseca S, Correia JR, Rodrigues MP, Branco FA. (2012). Artificial accelerated ageing of GFRP pultruded profiles made of polyester and vinylester resins: characterization of physical-chemical and mechanical damage. *Strain* 2012;48(2):162–73
- Canning L and Luke S (2010) Development of FRP bridges in the UK – an overview. *Advances in Structural Engineering* 13(5): 823–835.
- D'Amico, B., & Pomponi, F. (2018). Sustainability Tool to Optimise Material Quantities of Steel in the Construction Industry. In *Procedia CIRP* (Vol. 69, pp. 184–188). Elsevier B.V. <https://doi.org/10.1016/j.procir.2017.10.006>
- D'Antino, T., & Pisani, M. A. (2018). Influence of sustained stress on the durability of glass FRP reinforcing bars. *Construction and Building Materials*, 187, 474–486. <https://doi.org/10.1016/j.conbuildmat.2018.07.175>
- Daniel RA. (2010). A composite bridge is favoured by quantifying ecological impact. *Struct Eng Int J Int Assoc Bridge Struct Eng (IABSE)* 2010;20(4):385–91.
- DBIS (Department for Business, Innovation and Skills). (2010). Low Carbon Construction. Innovation and Growth Team: Emerging Findings. DBIS, London.
- Hernández-Moreno, S. (2012). Introducción a la planeación de la vida útil en proyectos de arquitectura y edificación. México: Plaza y Valdés.
- Hernández-Moreno, S., Ocaña-Ponce, J. A., & Mejía-López, M. (2015). Application of ISO 15686 to estimate service life of a dome built with adobe technology in the city of Toluca, Mexico. *Acta Universitaria*, 24(6), 16–20. <https://doi.org/10.15174/au.2014.668>
- Knippers J et al. Bridges with glass fibre-reinforced polymer decks: the road bridge in Friedberg, Germany. *Struct Eng Int J Int Assoc Bridge Struct Eng (IABSE)* 2010;20(4):400–4.
- Koch, G. (2017). Cost of corrosion. In *Trends in Oil and Gas Corrosion Research and Technologies: Production and Transmission* (pp. 3–30). Elsevier Inc. <https://doi.org/10.1016/B978-0-08-101105-8.00001-2>
- Mara, V., Haghani, R., & Harryson, P. (2014). Bridge decks of fibre reinforced polymer (FRP): A sustainable solution. *Construction and Building Materials*, 50, 190–199. <https://doi.org/10.1016/j.conbuildmat.2013.09.036>
- Resins BDDC, et al. (2009). LCA Composietbrug Eindrapport (2e versie) Vertrouwelijk. BECO Groep, Vestiging Rotterdam, mei 2009.
- Salh, L. (2014). Analysis and Behaviour of Structural Concrete Reinforced with Sustainable Materials. Masters Thesis, University of Liverpool. Retrieved from <http://livrepository.liverpool.ac.uk/id/eprint/16333>
- Sheikh, S. A., & Kharal, Z. (2018). Replacement of steel with GFRP for sustainable reinforced concrete. *Construction and Building Materials*, 160, 767–774. <https://doi.org/10.1016/j.conbuildmat.2017.12.141>
- Thodesen CC, et al. D6.4: comparative analysis of best practices: review of existing methods and development of an indicator suite for pantura goals. PANTURA; 2012.
- Zhang C and Canning L (2011) Application of non-conventional materials in construction. *Proceedings of the Institution of Civil Engineers, Construction Materials*. 164(4): 165–172.
- Zhang C, Amaduddin M, Canning L. (2011) Carbon dioxide evaluation in a typical bridge deck replacement project. *Proc Inst Civil Eng Energy* 2011;164(4): 183–94.

Method For The Selection Of Water Supply System (WSS) Project (Case Study: East Java Province WSS)

1st Riska Dewi Wijayanti
Civil Engineering Department, Faculty
of Civil, Environmental & Geo
Engineering
Institut Teknologi Sepuluh Nopember
(ITS)
Surabaya, Indonesia
riska.dw@gmail.com

2nd Hitapriya Suprayitno
Civil Engineering Department, Faculty
of Civil, Environmental & Geo
Engineering
Institut Teknologi Sepuluh Nopember
(ITS)
Surabaya, Indonesia
suprayitno.hita@gmail.com

3rd Endah Angreni
Technology Management Department
Institut Teknologi Sepuluh Nopember
(ITS)
Surabaya, Indonesia
angreni_bums@yahoo.com

Abstract—The availability of proper water is one indicator of the welfare of the Indonesian people, as stated in the settlement infrastructure development in the 2020-2024 target of 88% water service in 2024. The Government, through the PSPAM Working Unit, assists a stimulant program for Local Governments, in achieving water service targets. The limitation of the budget leads to the prioritization of WSS projects. This study is aimed to develop a method for selecting WSS development programs with program priorities and budget optimization. The selection method begins with the identification of existing WSS conditions and evaluates the function of assets in each district. Priority sequence of the program was carried out by using Multi-Criteria Analysis (MCA) approach. Determination of priority criteria is based on the Strategic Policy for WSS Development, literature study, and expert judgment. The priority sequence is the result of a calculation between the weighting of district criteria and the WSS project that carried out by experts by using Borda analysis method. The budget optimization process uses the breadth-first search algorithm to accommodate aspects of equitable development. The developed method will be recommended for PSPAM Working Unit to be used in the selection of WSS Infrastructure Development Programs.

Keywords—water supply system, infrastructure management, priority, selection, multi-criteria analysis

I. INTRODUCTION

The availability of proper water is one indicator of the welfare of the Indonesian people, as stated in the settlement infrastructure development in the 2020-2024 target of 88% water service in 2024. Based on data from the Central Statistics Agency (BPS) in 2017 the achievement of access to national drinking water is 72.04%, so to achieve the target of 88% in 2024 there is still GAP of 15.96%. For East Java Province, access to decent drinking water is 76.44% and has GAP against the target of 88% of 11.56% or around 4.5 million if multiplied by the population projection of East Java in 2019.

One effort to improve drinking water services is the development of adequate drinking water infrastructure. The Central Government, through the Provincial Water Supply Working Unit (PSPAM Working Unit), assists WSS Infrastructure Development Programs as a stimulant program for Local Governments in achieving drinking water service targets. The Local Government submits a proposal for SPAM development projects to PSPAM Working Unit according to the procedure. However, the limitation of the APBN budget

leads to the prioritization of SPAM projects. PSPAM Working Unit has to be able to allocate funds on target and get maximum benefits. The existing method cannot assess the potential and water needs of the district and set programs priorities to optimize the available budget. The main consideration in determining the priority of the SPAM development program are the Ministry of PUPR Policy, availability of funds, condition of PDAM, and commitments of local governments (Suprayitno, et al. 2018).

Therefore a method for selecting SPAM infrastructure development programs is needed, in accordance with the local needs and the availability of budget allocations. The method for selection of this SPAM infrastructure development program can be used as a reference in decision making for the PSPAM Working Unit in East Java to prioritize programs and budget maximization.

II. LITERATURE REVIEW

A. Water Supply System (SPAM)

Based on the Public Work Minister Regulation 122 of 2015 concerning Water Supply Systems (SPAM), SPAM is a single unit of water supply facilities and infrastructure. Types of water supply systems include SPAM pipeline network and SPAM instead of piping networks. Pipeline network SPAM components include raw water units, production units, distribution units, and service units. Whereas SPAM is not a piping network consisting of shallow wells, pumping wells, rainwater reservoirs, water terminals, and spring catching structures.

SPAM development is an activity carried out related to the availability of SPAM facilities and infrastructure to meet the quantity, quality, and continuity of drinking water which includes new development, improvement, and expansion (PERMEN PU 122/PRT/M/2015). Based on the regulation, program assistance was provided by the Central Government through the PSPAM Satker to the Regional Government to support the increase in coverage of drinking water services. The SPAM development program has the readiness of the program criteria as a prerequisite for the proposed activities proposed by the Regional Government as follows: (1) New Development, this program is intended for regions in districts /cities that have less than 50 liters per second, there are

potential customers, raw water sources are available, the ability to pay rates and there are management institutions. (2) Increased SPAM Capacity, this program is to increase the capacity of raw water units and production units, intended for areas that already have SPAM, are still functioning and have insufficient capacity. (3) Pipeline Network Development, a program to utilize the remaining capacity in the production unit with the construction of piping networks and have an idle capacity of more than 30%.

Planning for SPAM infrastructure development refers to existing conditions, including the status of the assets built. For this reason, it is necessary to manage infrastructure assets based on the principles of Infrastructure Asset Management. Infrastructure Asset Management is knowledge, science or program to manage the infrastructure to be able to execute its function sustainably, effectively, efficiently and always conform to the sustainability principle (Suprayitno and Soemitro 2018).

Some previous studies on determining priorities in project selection became a reference in this study. Priority setting of provincial road maintenance project proposals with parameters that are in accordance with regional conditions. The criteria used in determining priorities are superior commodity, travel time, travel costs, population, public facilities, worship, community participation, public transport routes, land use, distance traveled, accessibility, road damage, vehicle characteristics, traffic volume, road capacity (Fataruba and Soemitro 2006). Priority in determining the rehabilitation of school buildings based on two stages of criteria. First, the district criteria included area, population density, population growth and school criteria including damage level, number of students, age of the building, building location and net enrollment rate (Sudharmono et al. 2010)

B. Determination of Priority for SPAM Development Program

To set priorities for the SPAM development program, priority criteria based on regulations related to Strategic Policy for SPAM Development, literature studies, and interviews with stakeholders or experts are needed. Whereas to determine the level of importance of criteria, it is necessary to use a multi-criteria analysis approach. In this study, the method used was Borda. The principle of the Borda method is to rank existing alternatives (Bouyssou, 2006). Alternatives that have the highest rank are given the highest score, and so on the decrease in rank then given a lower score for ranking below, the lowest ranking is given a score of 0 or 1. The idea of Borda's method is to require voters to rank each candidate, and assign values to each rank, for example, the first rank is given a value of 2, the second rank is given a value of 1, and the third rank is given a value of 0 (Silva, 2009).

C. Usage of Budget Maximization

In this study, there are obstacles, namely the limitations of the APBN budget allocation to the PSPAM Work Unit, so it is necessary to maximizing the available budget to get the maximum result of the selected programs. Related to the even distribution aspect of SPAM development, the Breadth First Search (BFS) algorithm is used so that the first level priority program will be taken from each city. On a search with the BFS algorithm, the search starts from the first level (level 0) until the node on that level runs out, then proceed to the leftmost child at the next level (level 1) and so on until the node at that

level runs out. If the node at that level has run out, the search moves to the next level. And so on, until the goal is found (Kandaga 2008).

III. RESEARCH METHOD

A. Analysis Unit, Population, and Sample

Analysis unit on this research based on district SPAM proposals means the output expected was a proposed order of prioritized SPAM programs and related to budget allocation. Analysis unit restricted to proposed SPAM programs from 4 districts in East Java province. The research location was chosen by the performance condition of PDAM along with its services in urban and rural areas expected to represent the district condition in East Java province.

B. Method for Collecting Data

The analysis is based on primary data and secondary data. Primary data is obtained from questionnaires and interviews with relevant parties in determining SPAM development priorities. Data collection is used to obtain information measuring the level of importance of criteria for priority setting. The selected respondents were Stakeholders who determined SPAM development policies, including the Kasatker and PPK in the Satker PSPAM and experts from academics and PDAMs. The selection of these respondents with the consideration of having the right information on the aims and objectives of the research, knowing and understanding the problems of SPAM development. The first stage of the questionnaire to stakeholders and experts related to determining the criteria in SPAM development priorities and the stages in determining the priority level of SPAM development criteria. The calculation in the second stage questionnaire will use the Borda method to determine the importance of the criteria used in the study.

While secondary data is collected from the literature related to the SPAM development as well as the policy includes the Strategic Policy for SPAM Development, Government Regulations related to the implementation of SPAM, RISPAM, RPIJM, and BPS. Secondary data analysis is used in the process of identifying district water needs, collection of project proposals for district SPAM activities, district SPAM performance appraisal, determination of the appropriate State Budget SPAM program, and assessment of the readiness criteria for district SPAM activities.

IV. ANALYSIS AND DISCUSSION

The purpose of this study is to develop a method for selecting the SPAM development program. The conceptual framework in the preparation of methods is based on two components, including the State Budget SPAM Program and the District Government. In the APBN SPAM Program, the Policy and Strategy for SPAM Development is the basis for the implementation of SPAM, and the recording of the budget ceiling becomes a constraint in the preparation of the annual SPAM program for the PSPAM Satker. While the District Government proposed SPAM activities through the SIPP website in accordance with the plans for the development of SPAM in each district. The number of SPAM activity proposals from the District / City and the limitations of the APBN budget so that it is necessary to do a selection process on proposals submitted by the District Government. In this selection process, SPAM activity proposals that are in

accordance with drinking water requirements will be selected as a result of the analysis of existing SPAM conditions. Next will be the process of prioritizing the proposed SPAM activities that have been selected, as shown in Fig. 1.

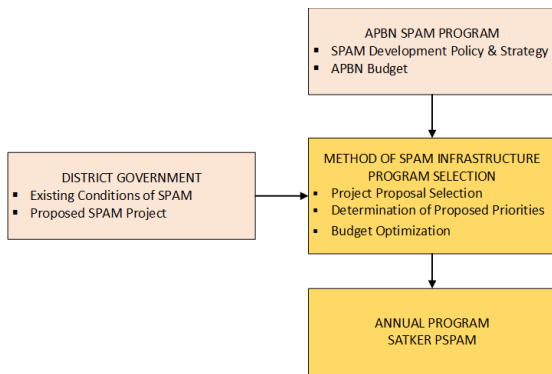

Fig. 11. Conceptual Framework Method

In the prioritization process, SPAM program priority criteria are obtained from regulations, literature studies, and experts to produce a sequence of proposed activities according to their priorities. Furthermore, related to the budgetary limitations of APBN, it is necessary to optimize the available budget so that the annual SPAM program is produced in accordance with the priorities and accordance with budget estimates. The method for selecting SPAM infrastructure programs includes the proposal selection process, prioritizing project proposals SPAM and optimizing the APBN budget available. With the method of selecting the SPAM infrastructure program, it will produce an annual SPAM program that can be used as a reference in decision making for the Satker PSPAM Jawa Timur. The stages in the making of the method for selecting the SPAM development program are carried out sequentially according to the research objectives, as shown in the following Fig. 2 below.

A. Stages of Research

The stages in this study are as follows: (1) identification of existing SPAM conditions, district water real needs, proposed project SPAM development, (2) verification of district project proposals based on readiness criteria, (3) determining priority criteria and the weight of the criteria for the SPAM infrastructure development program, (4) formulating the priority of the SPAM development program, (5) optimizing costs in accordance with the APBN budget allocation.

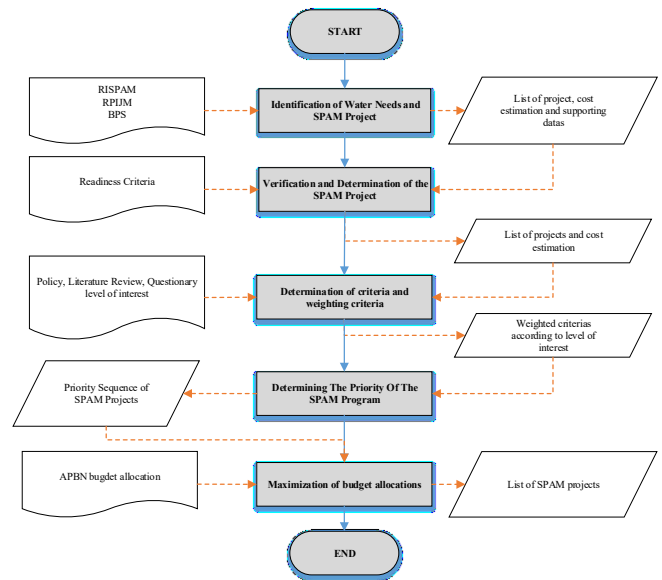

Fig. 12. Method For The Selection Of Water Supply System (WSS) Project

B. Implementation of method

- Identification of Water Needs and Proposed SPAM Projects

The forming of the SPAM development program carried out by the PSPAM Working Unit based on the proposed SPAM projects from all district by the SPAM plans of the district listed in the RISPAM and district RPIJM documents. In the framework of implementing proper planning and budgeting, the Directorate General of Human Settlements applies the Planning and Budgeting Information System (SIPPa) electronically. SIPPa functions as an application that accommodates planning and budgeting processes, updating basis planning data, evaluating proposed activities (based on compliance with Readiness Criteria), monitoring proposed activities, and assisting in the decision-making process. With the existence of SIPPa, the PSPAM Working Unit is tasked with verifying the district proposal along with supporting data.

At this stage data collection on existing SPAM conditions and the real needs of drinking water is carried out as a reference for the PSPAM Working Unit to verify proposals submitted by the district. Data needed is shown in Table I:

TABLE II. RESEARCH LOCATION

District	Total Population	Water Services Coverage	Unserviced Population	National Priority Location	PDAM Performance Index
Sidoarjo	2.202.813	76,78%	511.493	YES	3,18
Probolinggo	1.109.667	51,43%	538.965	NO	2,61
Mojokerto City	144.198	60,58%	56.843	YES	2,34
Kediri City	319.252	66,48%	107.013	YES	2,89

- Verification and Determination of the SPAM Projects

The proposal verification phase aims to ensure that the proposed projects meet the prescribed readiness criteria and determine the SPAM Development program that is by the

existing SPAM conditions. The Readiness Criteria of the ABPN SPAM program include RISPAM, JUSTEK, DED, RAB, DDUB, Readiness of asset handover, Raw Water Permit, Existence of Management Institution, Proof of Land Availability and letter of statement from the Regional Head.

There are two verification processes, (1) Technical verification is carried out based on SPAM planning technical guidelines. (2) Cost verification is carried out to ensure the estimated cost of the proposed activity is reasonable and by the system requirements. The verification reference is based on cost standards for similar work carried out by the PSPAM Work Unit. From the results of the verification proposal, some proposals do not meet the requirements so that they must be eliminated. The proposed SPAM projects from the district will be adjusted to the existing State Budget SPAM Program. The types of APBN programs broadly include (1) New SPAM Development Program. (2) SPAM Capacity Enhancement Program and (3) Piping Network Development Program. The results of the proposal verification, for example, in Sidoarjo district are shown in Table II. The explanation of project codes is shown in Table III.

TABLE III. RESULTS OF VERIFICATION

District	Location	Project Codes	Program	House Connection Target	Water Lack Area	Cost Estimation (millions rupiah)	Readiness Criteria Score	Verification
Sidoarjo	Candi	U001	3	3.000	NO	10.000	0,80	1
Sidoarjo	Tulangan	U002	3	5.200	NO	18.797	0,60	1
Sidoarjo	Buduran	U003	3	5.000	YES	18.000	0,50	0
Sidoarjo	Sukodono	U004	3	3.150	YES	10.087	0,60	0

TABLE IV. RESULTS OF VERIFICATION

District	Location	Project Codes	Project Names	Program
Sidoarjo	Candi	U001	Procurement and Installation of Main Distribution Networks of Umbulan II SPAM with a diameter of 500-300 mm	Piping Network Development Program
Sidoarjo	Tulangan	U002	Procurement and Installation of Secondary Distribution Networks of Umbulan II SPAM 200-100 mm in diameter	Piping Network Development Program
Sidoarjo	Buduran	U003	Procurement and Installation of Umbulan II SPAM Tertiary Distribution Networks he is 100-75 mm	Piping Network Development Program
Sidoarjo	Sukodono	U004	Procurement and Installation of Umbulan II SPAM Tertiary Distribution Networks he is 100-75 mm	Piping Network Development Program

• Priority Determination Criteria

The analysis of determining the priority criteria in the making of the method for selecting the SPAM development program based on the strategic policy of national SPAM development, stakeholders and experts related to the implementation of SPAM development in regencies/cities. From the results of questionnaires from stakeholders and experts, there are important criteria in determining the priority of SPAM program selection as follows:

Stage 1, District assessment, the criteria include Coverage of Drinking Water Services, Locations of National Priorities, Local Government Support, PDAM Performance, Regencies/Cities Fiscal Capacity.

Stage 2, assessment of Proposed SPAM Activities, the criteria include Served Population Targets, Water-Prone Areas, Readiness of Readiness Criteria, Ease of Implementation of Work.

Stakeholders and experts also give weighting criteria to measure the importance of each criterion that will be an assessment of proposed programs that have been previously verified. Determining the weight of this criterion will be calculated using the Borda method so that the weight of each criterion is obtained. Calculation of criteria for District criteria and Proposed questionnaire results are as shown in Table IV and V:

TABLE V. DISTRICT CRITERIA WEIGHTING

Criteria	Drinking Water Coverage	National Priority Location	Local Government Support	Fiscal Capacity	PDAM's Performance Index
Weight	0,324	0,068	0,243	0,149	0,216

TABLE VI. SPAM PROJECT CRITERIA WEIGHTING

Criteria	Water Lack Area	Served Population Target	Readiness Criteria	The Convenience Of Project Work
Weight	0,300	0,260	0,280	0,160

From the calculation results for the Districts criteria, the highest weight is the criteria for Drinking Water Coverage, and for the criteria for SPAM Project, the highest weight is the criteria for Water Lack Areas. Priority ranking of proposed programs is carried out by combining Regencies/Cities assessments with the assessment of each proposal. So that we get the priority sequence of the SPAM program in the Province and the order of each District.

• The Calculation Process in Determining Priorities

Priority analysis is based on District assessments and assessment of proposed projects. In accordance with the weight of the criteria calculated in the previous stage, then the assessment is carried out by multiplying the values for each criterion by the weighting of the criteria. The calculation of District assessment is shown in Table VI and Table VII. The unit value of each criterion is different so that in order to be calculated in number, the value is

made on a scale with the same range of values, namely scale 1-5.

TABLE VII. SCORE CALCULATION OF DISTRICT

District	Coverage of Drinking Water Services (weight = 0,32)	The National Priorities Locations (weight = 0,07)	Support from The Local Government (weight = 0,24)	PDAM Performance Index (weight = 0,15)	Local Fiscal Capacity (weight = 0,22)
Sidoarjo	1	2,33	2,60	5	1
Probolinggo	5	1	1	2,29	3,90
Mojokerto City	3,56	5	1,8	1	5
Kediri City	2,63	3,67	5	3,62	4,85

TABLE VIII. THE RESULT OF DISTRICT PRIORITIES

District	Coverage of Drinking Water Services	The National Priorities Locations	Support from The Local Government	PDAM Performance Index	Local Fiscal Capacity	District Score	District Weight
Sidoarjo	0,32	0,16	0,63	0,74	0,22	2,07	0,17
Probolinggo	1,62	0,07	0,24	0,34	0,84	3,11	0,25
Mojokerto City	1,15	0,34	0,44	0,15	1,08	3,16	0,26
Kediri City	0,85	0,25	1,22	0,54	1,05	3,90	0,32

The calculation of SPAM Projects in an example Sidoarjo District are shown in Table VIII and Table IX.

TABLE IX. SCORE CALCULATION OF SPAM PROJECTS

District	Project Codes	Water Lack Area (weight = 0,30)	Served Population Target (weight = 0,26)	Readiness Criteria (weight = 0,28)	The Convenience Of Project Work (weight = 0,16)
Sidoarjo	U001	1	1,8	5	4,33
Sidoarjo	U002	5	1	3,29	1
Sidoarjo	U003	5	2	1	5
Sidoarjo	U004	1	5	2,6	1,67

TABLE X. THE RESULT OF SPAM PROJECTS PRIORITIES IN SIDOARJO DISTRICTS

District	Project Codes	Water Lack Area	Served Population Target	Readiness Criteria	The Convenience Of Project Work	Project Score	Project Weight	Rank of Priority
Sidoarjo	U001	0,3	0,46	1,4	0,69	2,861	0,251	2
Sidoarjo	U002	1,5	0,26	0,92	0,16	2,840	0,249	3
Sidoarjo	U003	1,5	0,52	0,28	0,8	3,100	0,272	1
Sidoarjo	U004	0,3	1,3	0,73	0,27	2,595	0,228	4

The result of the assessment of each project proposal for all districts by provincial priority ratings as in Table X.

TABLE XI. THE RESULT OF PROVINCE PROJECTS PRIORITIES

District	Project Codes	Cost Estimation (millions rupiah)	Project Weight	District Weight	Total Score for Province Level	Rank of Priority
Sidoarjo	U001	10.000	2,861	0,17	0,484	14
Sidoarjo	U002	18.797	2,840	0,17	0,481	15
Sidoarjo	U003	18.000	3,100	0,17	0,525	13
Sidoarjo	U004	10.087	2,595	0,17	0,439	16
Probolinggo	U005	22.980	3,128	0,25	0,796	7
Probolinggo	U006	5.470	3,911	0,25	0,994	5
Probolinggo	U007	13.230	3,676	0,25	0,935	6
Probolinggo	U008	6.809	2,302	0,25	0,585	12
Probolinggo	U009	9.000	2,873	0,25	0,731	10
Kediri City	U010	7.680	4,207	0,26	1,085	3
Kediri City	U011	3.500	2,864	0,26	0,738	8
Kediri City	U012	6.755	2,523	0,26	0,650	11
Kediri City	U013	3.600	2,840	0,26	0,732	9
Mojokerto City	U014	8.900	3,413	0,32	1,087	2
Mojokerto City	U015	12.450	3,284	0,32	1,046	4
Mojokerto City	U016	4.580	3,960	0,32	1,261	1

According to Table 10, the first rank priority of the SPAM project is U016 from the City of Mojokerto because it has the highest value at the provincial level, and the last rank is U004 from Sidoarjo. Calculation of project priority ranks is based on project value multiplied by district weight.

• Maximization of Budget Allocations

In this study, there are obstacles, namely the limitations of the APBN budget allocation in the PSPAM Working Unit, so it is necessary to maximize the available budget to get the optimal benefit of the selected program. Related to the even distribution aspect of SPAM development, the Breadth First Search (BFS) algorithm is used so that the first level priority program will be taken from each District. So that the analysis of budget optimization is done using the algorithm, as shown in Fig. 3 below.

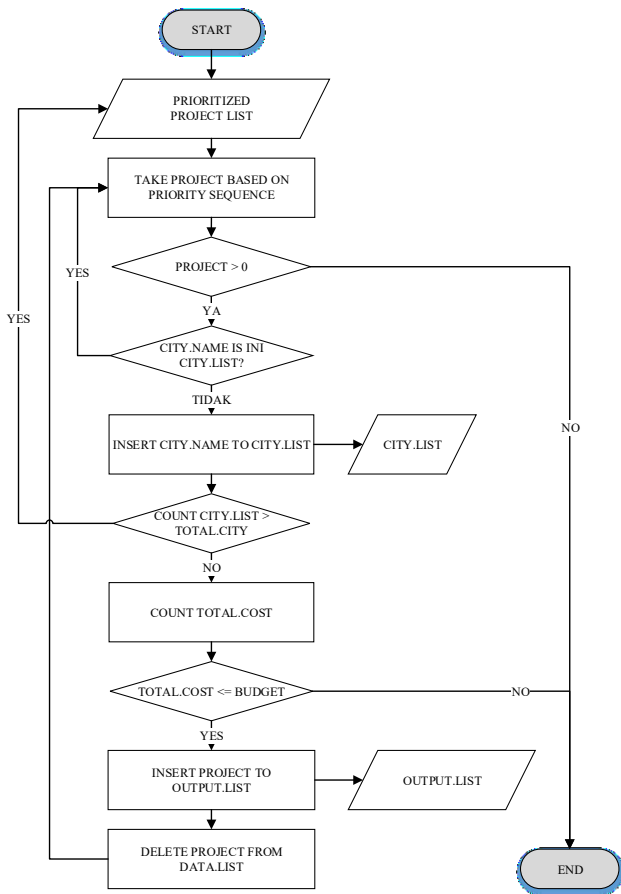

Fig. 13. Maximization Flow Chart

Determination of the provisional budget for calculations based on budget estimates, calculated from the average budget of the East Java PSPAM Working Unit from 2010-2018. So that the estimated budget used is Rp. 75,000,000,000. This budget estimate is used to limit the amount and value of proposals with optimal benefit values. In this stage, the provincial priority SPAM projects are processed to maximize budget allocations according to the algorithm. The Result of budget usage maximization is shown in Table XI.

According to Table XI, the results of the calculation of budget maximization in accordance with the priority sequence and aspects of equity in development are 9 SPAM projects from 4 districts. The total number of all selected projects according to the available budget is 75,000,000,000.

TABLE XII. THE RESULT OF PROVINCE PROJECTS PRIORITIES

Districts	Project Codes	Rank of Priority	Sequence of maximization	Selected Project		Iteration
				Priority	Cost Estimation (millions rupiah)	
Mojokerto City	U016	1	1	1	4.580	1
Mojokerto City	U014	2	5	2	8.900	2
Kota Kediri	U010	3	2	3	7.680	1
Mojokerto City	U015	4				
Probolinggo	U006	5	3	5	5.470	1
Probolinggo	U007	6	6	6	13.230	2
Probolinggo	U007	7				
Kota Kediri	U011	8	7	8	3.500	2
Kota Kediri	U013	9	9	9	3.600	3
Probolinggo	U009	10				
Kota Kediri	U012	11				
Probolinggo	U008	12				
Sidoarjo	U003	13	4	13	18.000	1
Sidoarjo	U001	14	8	14	10.000	2
Sidoarjo	U002	15				
Sidoarjo	U004	16				
TOTAL					75.000	

V. CONCLUSIONS AND RECOMMENDATIONS

The method for selection of SPAM Project has been developed. The making of the method was carried out by identifying the existing conditions and the real needs of District for drinking water, verifying the SPAM project proposals, determining criteria and weighting SPAM development priority criteria, determining the priority of proposed projects and maximization budget allocations. The criteria used to determine the priority of SPAM development are coverage of drinking water services, the national priorities locations, support from the local government, local fiscal capacity, PDAM performance index and the existence of water lack areas, easiness of project construction, served population target, and project readiness level. Maximization of budget allocations is done by considering equitable development and using the BFS algorithm. Simulations are carried out in 4 Districts in East Java Province.

The results of this study are expected to get SPAM development program proposals according to priorities and budget allocations. So that the developed method can be used as a reference in making decisions for the PSPAM Working Unit. The results of the research can be developed into an applicative model to support the planning of the SPAM development program by perfecting several assumptions with the use of more accurate data references through further analysis. Simulations need to be carried out in another district with more varied SPAM conditions.

REFERENCES

- Bouyssou, D., Marchant, T., Pirlot, M., Tsoukias, A. And Incke, P. (2006). *Evaluation and Decision Models With Multiple Criteria*, Springer-Verlag, Inc., New York.
- Fataruba, Muzain., & Soemitro, R.A.A., (2006). Evaluasi perbandingan penentuan prioritas usulan proyek pemeliharaan jalan provinsi berdasarkan kemampuan daerah otonom di Provinsi Sulawesi Selatan. Prosiding Seminar Nasional Manajemen Teknologi IV Program Studi MMT-ITS. Surabaya 5 Agustus 2006.
- Kandaga, T., Hapendi, A. (2008). Evaluasi dan Usaha Optimalisasi Algoritma Depth First Search dan Breadth First Search dengan Penerapan pada Aplikasi Rat Race dan Web Peta. *Jurnal Informatika*, Vol. 4, No.1, Juni 2008.
- Silva, Vanessa B.S., Morais, D.C., Almeida, D. And Adiel, T. (2009). Prioritising Complex Issues of Hydrographic Basin Committees by Group Decision Approach. *Brazilian Journal Of Operation & Production Management*, No 1, Vol 7, Brazil.
- Sudharmono, Eko., Wiguna, IPA., Sudarma, Erwin., (2010). Analisis penentuan prioritas kegiatan rehabilitasi bangunan gedung sd negeri dalam perencanaan pembangunan daerah di Kab Tulungagung. Prosiding Seminar Nasional Manajemen Teknologi XII Program Studi MMT-ITS. Surabaya 7 Agustus 2010.
- Suprayitno, H., & Soemitro, R.A.A., (2018). Preliminary Reflexion on Basic Principle of Infrastructure Asset Management. *Jurnal Manajemen Aset Infrastruktur & Fasilitas*. Vol. 2, No. 1, Maret 2018.
- Suprayitno, H., Wijayanti, R.D. & Angreni, E. (2018). Main Considerations for Annual Program Decision Making for PKPAM Working Unit, Direktorat General Cipta Karya in East Java. *Jurnal Manajemen Aset Infrastruktur & Fasilitas*. Vol. 2, Edisi Khusus, Desember 2018.
- Peraturan Pemerintah Nomor 122 Tahun 2015 tentang Sistem Penyediaan Air Minum.

Strategic Analysis of Workshop and Dormitory Building Utilization to Support Construction Training in Construction Service Office Unit IV Surabaya

1st Rizky Kurniasih
Students of Civil Engineering
Department, Faculty of Civil,
Environmental & Geo Engineering
Sepuluh Nopember Institute of
Technology
Jalan Raya ITS, Surabaya 60111,
Indonesia
always.qqs@gmail.com

2nd I Putu Artama Wiguna
Civil Engineering Department, Faculty
of Civil, Environmental & Geo
Engineering,
Sepuluh Nopember Institut of
Technology
Jalan Raya ITS, Surabaya 60111,
Indonesia
artama@ce.its.ac.id

3rd Ria Asih Aryani Soemitro
Civil Engineering Department, Faculty
of Civil, Environmental & Geo
Engineering,
Sepuluh Nopember Institut of
Technology
Jalan Raya ITS, Surabaya 60111,
Indonesia
ria@ce.its.ac.id

Abstract—Construction Service Office Unit IV Surabaya is one of the work units of Ministry of Public Works and Housing. This work unit have the assets of a workshop and dormitory building which functions to support its duties in carrying out construction training. However, the level of utilization of the building is still low, so it is rarely used and has not been used optimally to support the duties and functions of the work unit especially for construction training. The purpose of this study was to analyze the strategies for the utilization of workshops and dormitories to support training in construction. This research is a case study with data collection techniques that use observation, semi-structured interviews and closed questionnaires to respondents from the workshop and dormitory building management at Construction Service Office Unit IV Surabaya. The sampling technique with purposive sampling is a sampling technique used by researchers if researchers have certain considerations in sampling or determining samples for specific purposes. To obtain the right strategy and in accordance with the internal and external environmental conditions of the work units, the strategy formulation include input stages with Internal and External Evaluation Matrix, matching stages with Strength-Weakness-Opportunity-Threat Matrix, Internal External Matrix, Strategic Position and Action Evaluation Matrix, Grand Strategy Matrix and decision stages with Quantitative Strategic Planning Matrix. From the results of the study, the position of works units was in Quadrant 2, so the appropriate strategy was to improve cooperation with external parties, such as Local Government, Construction Services Associations, Construction Professional Certification Agency, Contractors and Vocational Schools to organize construction training that utilizes workshop buildings and dormitories.

Keywords— Building Utilization, Strategy Formulation, Market Penetration, Construction Service Office Unit IV Surabaya

I. INTRODUCTION

One of the National Medium Term Development Plans called *Rencana Pembangunan Jangka Menengah Nasional* (RPJMN) for 2014 - 2019 is an infrastructure development to support economic growth and national welfare equality. The existence of infrastructure will encourage other sectors to develop, because it can increase productivity, reduce

production costs, and create jobs. Massive infrastructure development has opened opportunities for business in the construction sector, especially as the government's commitment to provide infrastructure budgets is also consistent, the infrastructure budget in 2017 to 2018 reached 400 trillion or 17% of the total The Indonesian Budget (APBN) expenditure. The rise in infrastructure development has led to an increase in the need for construction workers. To give shape to quality infrastructure development in Indonesia, it requires the support and readiness of a competent national construction workers, so that the demand for competence and quality of labor in the field of construction is absolutely necessary in the next few years. The Central Government in this case is the Ministry of Public Works and Public Housing, has the authority to foster the construction workers, especially in improving workers' competence through training and certification.

Construction Service Office Unit IV Surabaya (*Balai Jasa Konstruksi Wilayah IV Surabaya*) is one of the Technical Units under the Ministry of Public Works and Public Housing. In accordance with Minister of Public Works and Housing Regulation No. 20/PRT/M/2016 concerning Organizations and Work Procedures of Technical Units at the Ministry of Public Works and Public Housing, the duties and functions of Construction Service Office Unit IV Surabaya is to perform empowerment and supervision of field construction services. One form in the function of empowering construction services is to perform a expert and skilled construction training. To conduct this function, the works unit has assets in the form of buildings consisting of workshop buildings, dormitories, halls and classrooms that were built in 2002, and in 2015 to 2016 there has been done improvements to the workshop building and dormitories, so that the building can be used according to its function during its economic life.

Workshop and dormitory building in Construction Service Office Unit IV Surabaya is located in one center. The workshop building consists of welding, wood and

plumbing workshops that can accommodate 30 person. The dormitory building which consists of a *sapta taruna* guesthouse that can fit as many as 62 persons and a family dormitory which able to hold up to 80 person which serves as a temporary residence for participants who take part in training in construction.

As of today, the utilization rates of workshops and dormitories are still low to support construction training. The building is rarely used, for this reason the building is idle and has not been used optimally to assist the tasks and functions of the organization, especially in training the construction industry which causes the emergence of funds efficiency that is incomparable to the financial and non-financial benefits generated. Thus, there are potential resources and capacities that have not been fully utilized due to various limitations. This situation can result in a loss of opportunity to maximize the use of assets that conducted by Construction Service Office Unit IV Surabaya to facilitate the tasks and functions in the construction training and opportunity loss to obtain state revenues from optimizing the use of these assets through cooperation with external parties.

The assets of the workshop building and dormitories owned by work units have an important role to support the achievement of organizational goals in carrying out their duties and functions. Therefore, these assets must be managed optimally, because assets are one of the main factors that affect organizational performance (Siregar, 2004). Every physical asset needs to be maintained effectively, efficiently and useful so that it will become valuable, to ensure that, it requires a conceptual design for an asset management strategy (Sugiyama, 2013). Carn and Rabianski (1999) mention that asset management has attracted serious attention from the head of an organization, because as the organization's main support system, asset management's function is to be involved with in the determination of strategic decision making and establishing a path of new in activities that is more efficient and with the organization's goals and objectives. Good asset management requires the assistance of physical, human, financial and technological resources and information that is appropriate, hence there is a need to form the strategies that can adjust the organization's resources, in order to fit with the aim of the service delivery. Organizations need to identify and implement the best asset management practices through systematic strategic asset management of the entire decision-making process for each stage of the life cycle assets (Department of Treasury and Finance Tasmania Government, 2004).

Based on the description above, the purpose of this study is to conduct an appropriate strategy in the utilization of workshops and dormitories to provide construction training at Construction Service Office Unit IV Surabaya.

II. LITERATURE REVIEW

A. Asset Management

Asset management consists of two vocabulary, management and assets. As explained by Robbins (2007), management is the process of coordinating work activities so that the work is resolved efficiently and effectively with

and through other people. As claimed by Griffin (2004) management as a process of planning, organizing, coordinating, and controlling resources to accomplish goals effectively and efficiently. So it can be concluded that management is the process of planning, organizing, directing, and controlling to get effective and efficient goals.

The definition of assets based on the Indonesian Dictionary is something that has an exchange rate. According to Siregar (2004), the definition of assets is generally a thing or something (anything) or an exchange value that is owned by a business entity, agency, or individual. Asset management is a defiant step of the management of assets which aims to be able to optimize the utilization of assets, identify risks, anticipate potential risks that arise, and seek how an asset provides benefits to individuals / organizations until the technical age of the asset is wasted in accordance with management principles for the purpose of procurement of assets can be resolved effectively and efficiently.

B. Strategy

As specified by David (2016) strategies are a shared means with the long-term goals to be achieved. Includes geographical expansion, diversification, acquisition, product development, penetration, tightening, divestment, liquidation, and joint ventures. Formisano (2004) defines strategy as a detailed plan for achieving success, a collection of decisions and activities that we select to complete long-term goals. Strategy is the path we choose. Every organization needs to find out what things to be achieved and then what will it take to make it into reality, with its products, customers and operations. Shimizu (2012) describes strategies as plans for the future to fulfil certain goals. The strategy consists of identifying target customers, providing services / products that are better or cheaper than competitors, and capitalize on the uniqueness of the company. Then it can be concluded that the strategy is choices about the acts performed by an organization in order to achieve its goal and to settle competitive advantage. Strategy covers all aspects of the company. The strategy integrates all parts of the plan, harmonizes with each other and in accordance.

C. Strategy Management

As reported by David (2016) the meaning of strategic management is the arts and knowledge in formulating, implementing, and evaluating cross-functional decisions that enable an organization to accomplish its objectives. Strategic management focuses on efforts to integrate management, marketing, finance/ accounting, production/ operations, research and development, and computer information systems to achieve organizational success. According to Robbins (2007) strategic management is a group of managerial decisions and actions that determine the organization's long-term performance. So it can be concluded that the meaning of strategic management is a process or tactic of how a company can complete its objectives by synergizing organizational functions within it.

D. Asset Management Strategy

An asset management strategy is a continuous process to determine the range and level of assets needed to achieve

strategic goals (Clarence Valley Council, 2007). The asset management strategy framework aims to ensure informed decision-making by managers who invest and managing assets in accomplish the purpose of service delivery of an institution. In principle, the asset management strategy is to maintain the asset function in accordance with the plan and meet the gap between the needs of future assets and the current condition of the asset. The analysis results in the form of infrastructure asset management strategies that include maintenance of existing assets, rehabilitation of assets that require repairs, construction of new assets, solutions to the utilization of excess assets and non-asset solutions (Anwar & Supriyatna, 2003).

E. Workshop and Dormitory Building of Construction Service Office Unit IV Surabaya

Construction Service Office Unit IV Surabaya has duties and functions in executing training and competency test of construction especially to human resources. Some construction trainings held include Expert Level, consisting of Young Experts, Chief Supervisors, Field Managers, Assessors, Instructors and Training Officers Course (TOC) ; and Skilled Level, consisting of Practitioner, Overseers, Interpreters and Builders.

TABLE I. WORKSHOPS AND DORMITORY BUILDING OF CONSTRUCTION SERVICES UNIT IV SURABAYA

No	Building	The Name of The Building	Size	Information
1	Dormitories	Wisma Sapta Taruna	17.5 x 30 m	Consists of 2 floors 1 st floor = 12 rooms 2 nd floor = 19 rooms Capacity per room for 2 person
		Family Dormitory	18 x 49 m	Consists of 2 floors 1 st floor = 20 rooms 2 nd floor = 20 rooms Capacity per room for 2 person
2	Workshops	Welding	19.8 x 21.6 m	Capacity for 30 person
		Wood	12 x 28.8 m	Capacity for 30 person
		Plumbing	14 x 36 m	Capacity for 30 person

III. METHOD

A. Type of Research

As stated by Riduwan (2010) the research method explains what is used in research. This research is a case study method, in where case studies are well-supplied in empirical descriptions of certain phenomena that are usually based on various data sources (Yin, 2014). Case study research is the proper research strategy if the subject of a research question is related to how or why, and when a researcher has very few opportunities in controlling the

events that will be researched (Yin, 2014). This study aims to examine the strategy of utilizing building assets by analyzing the internal and external environment of the organization, so that the type of case study research is very appropriate to use.

B. Data Source

Sources of data in this study are primary data which gathered directly from the source, and collected by researchers with observation, field surveys, distributing questionnaires and interviews to respondents. This study also uses secondary data, by studying various writings through related literature books, regulations / NSPM, reports on activities relating to asset management, as well as literature studies on similar research conducted by previous researchers.

C. Data Collection

Data collection used in this study were interviews, field observations, and questionnaires to respondents. Interviews in this study were conducted by using a semi-structured form, adopting from the help of interview guidelines in need to facilitate and focus the questions submitted to respondents, while the questionnaire applied was a closed questionnaire, where respondents chose the answers provided. The respondents in this study were selected based on purposive sampling. The sampling technique with purposive sampling is a sampling technique that used by researchers if they have certain considerations in sampling or determining samples for specific purposes (Riduwan, 2010). The research sample was limited to 4 respondents, who have considerations linkages with the focus of research and involvement in the management of workshop and dormitory buildings to support construction training at Construction Service Office Unit IV Surabaya, such as Head of Construction Services Office Unit IV Surabaya, Head of Administration Sub Division, Head of Planning and Information Section, Head of Implementation and Quality Assurance Section. Each respondent is competent and experienced in managing the assets of the workshop and dormitory building for similar construction training.

D. Data Analysis

The analysis technique in this study includes the first stage, namely identifying indicators that include strengths, weaknesses, opportunities and threats in reliance on the results of interviews with respondents and giving weight and rating to each of these indicators. The second stage is formulating strategies using External Factors Evaluation (EFE) Matrix, Internal Factors Evaluation (IFE) Matrix, Internal External (IE) Matrix, Strategic Position and Action Evaluation (SPACE) Matrix, Grand Strategy Matrix, Streghts Weaknesses Opportunities Threats (SWOT) Matrix and Quantitative Strategic Planning Matrix (QSPM).

E. Strategy Formulation

1) Input Stage

a) Internal Factor Evaluation (IFE): The EFE matrix is used to evaluate the external factors of the organization which consist of opportunities and threats originating from

outside the organization. The steps in creating an EFE Matrix are as follows:

- Give weights for external factors as identified in the external audit process, with a range of 0.01 (not important) to 1.00 (very important). The sum of all weights against the factor must be equal to 1.00.

- Provide a rating between 1 and 4, for key external factors to indicate how effective the company's strategy is currently responding to these factors. Where 4 = the response is very good, 3 = the response is good, 2 = the response is bad and 1 = the response is very bad.

- Multiplying each factor weight by its ranking to figure a weighted score and add the weighted score for each variable to determine the total weighted score for the organization.

b) *External Factor Evaluation (EFE)*: The IFE matrix is used to evaluate internal organization factors which consist of strengths and weaknesses owned by the organization. The steps in creating an IFE Matrix are as follows:

- Give weights for internal factors as identified in the internal audit process, ranging from 0.0 (not important) to 1.0 (all important) for each factor. The factors that are considered to have the greatest effect on organizational performance are given the highest weight. The sum of all weights must be equal to 1.0.

- Ranks 1-4 on each factor to indicate whether the factor presents major weaknesses (rank = 1), small weaknesses (rank = 2), small strengths (rank = 3), and main strengths (rank = 4).

- Multiplying each factor weight by its ranking to determine a weighted score and add the weighted score for each variable to determine the total weighted score for the organization.

2) *Matching Stage*

a) *Internal External (IE)*: This matrix positions various divisions in the organization in a nine-cell view. The Internal External Matrix (IE) is based upon two key dimensions, the weighted total score of Internal Factor Evaluation (IFE) on the X axis and the weighted total score of External Factor Evaluation (EFE) on the Y axis.

b) *Strategic Position and Action Evaluation (SPACE)*: In SPACE matrix consists of internal dimensions (Financial Position, Stability Position) and external (Competitive Position, Industry Position) of an organization. There are four quadrant frameworks that can determine whether an aggressive, conservative, defensive, or competitive strategy is the one that best fits the organization. This rating on the SPACE matrix is founded on the results of the questionnaire to respondents with a score from 1 (poor) to 4 (excellent) to point the indicator of Financial Position and Industry Position moreover the score from -1 (excellent) to -4 (poor) to mark an indicator which is Stability Position and Competitive Position.

c) *Grand Strategy Matrix*: This matrix is used to formulate alternative strategies. The grand strategy matrix is on the basis of 2 (two) evaluative dimensions, competitive position and market growth. Organizations are positioned into 4 quadrants in the matrix grand strategy.

d) *Strengths Weaknesses Opportunities Threats (SWOT) Matrix*: An important matching instrument that helps decision makers to develop 4 (four) types of strategies, Strength-opportunity strategy (SO): uses internal power to take advantage of external opportunities. Weakness-Opportunity (WO): aims to increase internal weakness by taking advantage of external opportunities. Strength-threat strategies (ST): apply organizational strength to avoid or reduce the impact of external threats. Weakness-Threats (WT) Strategy: is a defensive tactic carried out to reduce internal weaknesses and avoid external threats.

3) *Decision Making Stage*

a) *Quantitative Strategic Planning Method (QSPM)*: QSPM is an analytical tool used for decision making strategies that will be used with reference to alternative strategies arranged in the previous stage. QSPM calculations are based on the weights in the EFE and IFE matrices and alternative strategies at the matching stage.

IV. RESULT AND ANALYSIS

A. Research Variable

The variables in this study are internal and external factors that influence the utilization of workshops and dormitories at Construction Service Office Unit IV Surabaya. These variables were obtained from literature studies and previous studies, as in Table II and Table III:

TABLE II. INTERNAL FACTORS

No	Factors	Indicators	Reference
1	Physical resources	Physical building conditions	Barney & Hesterly (2008), Wandriani (2012), Kurniawan (2016)
		Availability of training equipment	Barney & Hesterly (2008), Wandriani (2012),
		Opportunity of supporting facilities and building utilities	Barney & Hesterly (2008), Juarti (2015), Kurniawan (2016)
2	Human resources	Number of building management officers	Alkhafaji (2004), Barney & Hesterly (2008), Mandala (2012)
		Building staff competency	
3	Organizational resources	Organizational structure support	Barney & Hesterly (2008), Mandala (2012)
		Commitment support from leaders	Barney & Hesterly (2008), Kadarusman (2013)
		Support of the organization's primary tasks and functions	Barney & Hesterly (2008), Kurniawan (2016)
4	Finance	Possibility of funds	Alkhafaji (2004), Hamalik (2011)
5	Promotions	Media and promotion frequency	Fadjarwati & Pratami (2014), Fadjarwati & Koswara (2014)
6	Job Training Processes	Provided curriculum, methods and job training modules	Sulchan (2007), Noordi (2017)
		Presence of instructors	Sulchan (2007), Hamalik (2011)

TABLE III. EXTERNAL FACTORS

No	Factors	Indicators	Reference
1	Political	Support from central government	William (2009), Mandala (2012)
		External parties financing capabilities	
2	Economical	Price / rental rate	William (2009), Kurniawan (2016)
		The price of building materials	Supriyadi (2005), Sulchan (2007)
3	Social	Awareness in the job training	Wahyudi (2014), Febriyanti (2016)
4	Technological	Communication and information technology	William (2009), Kurniawan (2016)
5	Legal	Support of regulations	William (2009), Kurniawan (2016)
6	Environmental	Ease of access to the building and conditions around the location	William (2009), Hamalik (2011)
		The existence of a similar building	William (2009), Susanthi (2017)
7	Stakeholders	Collaboration and synergy support with stakeholders	Jauch & Glueck (2000), Rahmawati & Noor (2014), Mandala (2012)

After preparing the research variables, then the next phase is to conduct semi-structured interviews with respondents based on the research variables. From the results of the interviews, obtained which variables that are relevant to be used in this study.

The subsequent step is identifying the relevant research variables, followed by a conduct follow-up interviews with respondents to identify internal factor indicators including strengths and weaknesses, as well as external factor indicators that include opportunities and threats, as shown in Table IV.

TABLE IV. STRENGTHS, WEAKNESSES, OPPORTUNITIES, THREATS

Internal Factors	External Factors
<p><i>Strengths</i></p> <ol style="list-style-type: none"> Physical building structure in good condition (S1) Availability of equipment and adequate training equipment (S2) Support the structure of a systematic building management organization (S3) Commitment support from leaders to conduct training (S4) Support the primary tasks and functions of the organization in construction training (S5) Provided curriculum, training methods and modules that are in accordance with SKKNI (S6) 	<p><i>Opportunities</i></p> <ol style="list-style-type: none"> Central government support in training construction workers (O1) Progress of information and communication technology (O2) Support for applicable regulations regarding construction and management of State-Owned Property (BMN) (O3) Ease of access to locations and conducive conditions around the building (O4) Collaboration and synergy support with stakeholders (O5)
<p><i>Weaknesses</i></p> <ol style="list-style-type: none"> Lack of supporting facilities and building utilities (W1) Limited number of building management officers (W2) Building staff competency level that is not in accordance with the position (W3) Limitations on the allocation of funds for the implementation of training in buildings, which averages around 10% of the budget (W4) 	<p><i>Threats</i></p> <ol style="list-style-type: none"> External parties limited funding for construction training (T1) Unspecified rental tariff for workshop building and construction training rates (T2) Changes in the level of material price for construction training practice (T3) Low level of awareness of users and service providers to carry out construction training (T4)

5. Lack of promotional activities (W5)	5. The existence of other buildings that are used for similar construction training. (T5)
6. Limitations of teaching staff / instructors under the authority of the works unit (W6)	

From the results of the identification of indicators on internal and external factors in Table 4, the next step is giving weight and rating to each indicator in the internal and external factors based on the results of a closed questionnaire to the respondents. The weighting and rating results are then used for the next stage (input stage), which includes the EFE and IFE Matrix.

B. Input Stage

1) *External Factor Evaluation Matrix (EFE)*: The EFE matrix is a strategy formulation tool to summarize and evaluate opportunities and threats. The value of weighting and rating on the EFE matrix come from the results of the questionnaire to respondents. Whereas, The weighted average value of the EFE matrix is the product of the multiplication of weights and ratings on each indicator.

TABLE V. EFE MATRIX

No	External Factors	Weight	Rating	Weighted Score
Opportunities				
1	Central government support in training construction workers (O1)	0.101	3.50	0.355
2	Progress of information and communication technology (O2)	0.087	3.00	0.261
3	Support for applicable regulations regarding construction and management of State-Owned Property (BMN) (O3)	0.087	3.00	0.261
4	Ease of access to locations and conducive conditions around the building (O4)	0.109	4.00	0.435
5	Collaboration and synergy support with stakeholders (O5)	0.109	4.00	0.435
Threats				
1	External parties limited funding for construction training (T1)	0.116	2.00	0.232
2	Unspecified rental tariff for workshop building and construction training rates (T2)	0.101	3.00	0.304
3	Changes in the level of material price for construction training practice (T3)	0.101	2.00	0.203
4	Low level of awareness of users and service provider to implement construction training (T4)	0.101	3.00	0.304
5	The existence of other buildings that are used for similar construction training (T5)	0.087	3.00	0.261
Total		1		3.051

The results of the EFE Matrix are 3.051, this shows that Construction Service Office Unit IV Surabaya has responded with good enough chances and the threat that is

by making use of the headway that may overcome a threat that exist.

2) *Internal Factor Evaluation Matrix (IFE)*: The IFE matrix is an instrument that used to sum up and evaluate the strength of the functional areas and a key weakness in business. As in the EFE matrix, the result of weights and ratings on the IFE matrix come from the results of the questionnaire to respondents. And the value of weighted score is the multiplication of the weight and rating.

TABLE VI. IFE MATRIX

No	Internal Factors	Weight	Rating	Weighted Score
Strengths				
1	Physical building structure in good condition (S1)	0.096	4.00	0.386
2	Availability of equipment and adequate training equipment (S2)	0.096	4.00	0.386
3	Support the structure of a systematic building management organization (S3)	0.084	3.25	0.274
4	Commitment support from leaders to conduct training (S4)	0.084	3.25	0.274
5	Support the primary tasks and functions of the organization in construction training (S5)	0.090	3.75	0.339
6	Availability of curriculum, training methods and modules that are in accordance with SKKNI (S6)	0.078	3.00	0.235
Weaknesses				
1	Lack of supporting facilities and building utilities (W1)	0.072	2.00	0.145
2	Limited number of building management officers, (W2)	0.078	1.75	0.137
3	Building staff competency level that is not in accordance with the position (W3)	0.078	1.75	0.137
4	Limitations on the allocation of funds for the implementation of training in buildings, which averages around 10% of the budget (W4)	0.090	1.00	0.090
5	Lack of promotional activities (W5)	0.078	1.75	0.137
6	Limitations of teaching staff/ instructors under the authority of the works unit (W6)	0.072	2.00	0.145
Total		1		2.684

The IFE matrix result is 2.684, which means Construction Service Office Unit IV Surabaya has an average internal position.

C. Matching Stage

1) *IE Matrix*: From the results of the IFE and EFE matrix, the External Internal matrix is arranged, as in Fig. 1.

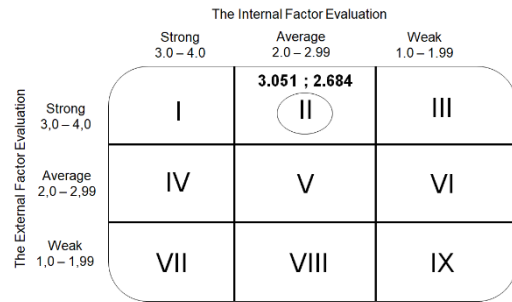

Fig. 1. IE Matrix

The IE matrix is relying on two key dimensions, the total IFE weighted average on the X axis and the total EFE weighted average on the Y axis. In the external internal matrix, the position of Construction Service Office Unit IV Surabaya is in Quadrant II, which is obtained from the IFE value of 2,684 and EFE value of 3,051. In this Quadrant, Construction Service Office Unit IV Surabaya is in a grow and build position, which means that the work units need a strategy to grow and develop for the better result. Intensive strategies such as market development, market penetration, product development and vertical or horizontal integration can be applied to this Quadrant.

2) *SPACE Matrix*: In government organizations, the dimensions used in the SPACE matrix consist of internal dimensions and external dimensions, so indicators in internal and external factors that were previously included in the EFE and IFE matrices are used as considerations in developing this SPACE matrix. From the results of questionnaires to respondents who deal directly with the management of workshop and dormitory building for construction training, the coordinates of the X-axis on SPACE Matrix is 0.10 which is the result of competitive position and industry position addition and Y-axis is -0.30 which is the result of financial position and stability position addition. Thereby, the position of the Construction Service Office Unit IV Surabaya is in the Conservative Quadrant. Therefore, market penetration, product development, or market development can be chosen according to the situation and conditions faced by the work unit.

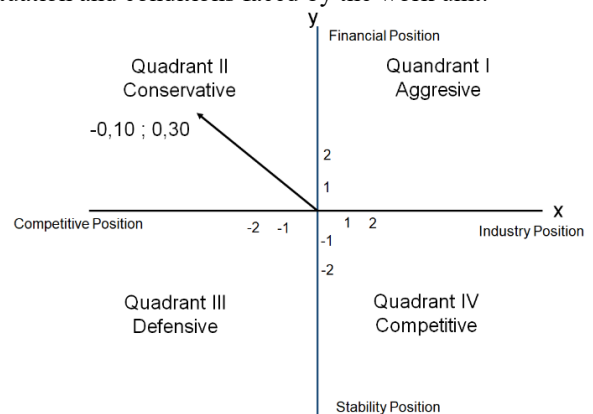

Fig. 2. SPACE Matrix

3) *Grand Strategy Matrix*: The Grand Strategy Matrix is a tool for formulating alternative strategies based on two dimensions, competitive position and market growth. In

terms of market growth, work units have several customers who are their market share and have various operational cooperation contracts with numerous agencies both from the government and the private sector in terms of implementing construction training by utilizing the workshop and dormitory building. In reference to the data obtained, the average growth rate of the workshop and dormitory building utilization for construction training from 2016 to 2018 was 5.39%. Whereas in terms of competitive position, based on the analysis of the SPACE matrix, showing work units have a weak competitive advantage. Thus, on the grand strategy matrix, Construction Service Office Unit IV Surabaya are included in quadrant II, thus the work units need to evaluate the approach to the market, because they are unable to compete effectively, also have low competitiveness. Because organizations in Quadrant II are in industries with rapid market growth, intensive strategies can be considered. However, if the organization lacks specific competence or competitive advantage, horizontal integration can be a good alternative.

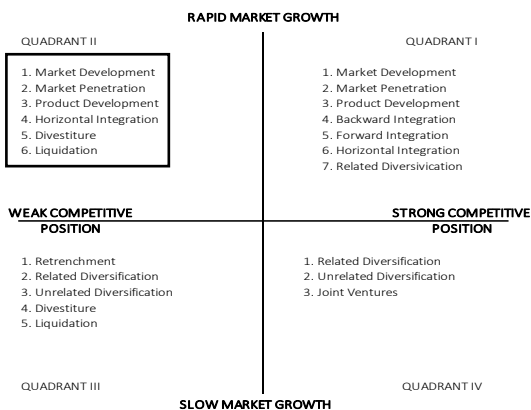

Fig. 3. Grand Strategy Matrix

4) *SWOT Matrix*: After compiling the EFE Matrix, IFE, IE Matrix, SPACE Matrix and Grand Strategy, the following step is to compile the SWOT matrix. In accordance with the results obtained in the previous stage:

- Internal External Matrix (IE), the work unit is in quadrant II which point out that the position of the work unit grows and built, therefore the appropriate strategy will be an intensive strategy such as market development, market penetration, product development and horizontal integration.

- SPACE matrix that refer to the work units which are in a conservative position, with weak competitive advantages, with rapid market growth. The appropriate strategy is an intensive strategy (market penetration, product development, or market development).

- Grand strategy which indicates that the work unit is in quadrant II, so that alternative strategies that can be applied by work units include market development, market penetration, product development or horizontal integration.

TABLE VII. ALTERNATIVE STRATEGIES

Strategies		Category
1	Establishing affordable tariff rates for workshop building and construction training so that they can be used as Non-Tax State Revenue objects and it can be used optimally by the external parties.	Product Development
2	Improving awareness of stakeholders in construction training through coordination forums as a medium of socialization and promotion	Market Penetration
3	Developing cost sharing system with external parties, so that the cost of construction training will be covered together therefore it will become more affordable	Market Penetration
4	Improving promotion activities by using information and communication technology such as website or social media and developed routine coordination forums with external parties	Market Penetration
5	Improving the cooperation with external parties, such as Local Government, Construction Services Associations, Certified construction institution services, Contractors and Vocational Schools to organize construction training that utilizes workshop buildings and dormitories.	Market Penetration

D. Decision Making Stage

From the various alternative strategies, the further step is to evaluate each of the alternative strategies using the QSPM matrix. The preparation of the QSPM matrix is form on the results of a closed questionnaire to the respondents.

TABLE VIII. QSPM

Key Factors	Weight	Strategy 1		Strategy 2		Strategy 3	
		AS	TAS	AS	TAS	AS	TAS
Opportunities							
O1	0.101	-	-	-	-	-	-
O2	0.087	-	-	-	-	-	-
O3	0.087	-	-	-	-	-	-
O4	0.109	-	-	-	-	-	-
O5	0.109	-	-	-	-	-	-
Threats							
T1	0.116	-	-	4.0	0.46	4.0	0.46
T2	0.101	3.0	0.30	-	-	3.0	0.30
T3	0.101	3.0	0.30	-	-	3.0	0.30
T4	0.101	-	-	4.0	0.41	-	-
T5	0.087	-	-	-	-	-	-
Total	1.00						
Strengths							
S1	0.096	3.0	0.29	-	-	-	-
S2	0.096	3.0	0.29	-	-	-	-
S3	0.084	-	-	-	-	-	-
S4	0.084	3.0	0.25	3.0	0.25	-	-
S5	0.090	3.0	0.27	3.0	0.27	-	-
S6	0.078	-	-	-	-	-	-
Weaknesses							
W1	0.072	-	-	-	-	-	-
W2	0.078	-	-	-	-	-	-
W3	0.078	-	-	-	-	-	-
W4	0.090	-	-	-	-	4.0	0.36
W5	0.078	-	-	-	-	-	-
W6	0.072	-	-	-	-	-	-
Total	1.00		1.71		1.39		1.43

TABLE IX. QSPM

Key Factors	Weight	Strategy 4		Strategy 5	
		AS	TAS	AS	TAS
Opportunities					
O1	0.101	3.0	0.30	3.0	0.30
O2	0.087	4.0	0.35	-	-
O3	0.087	3.0	0.26	2.0	0.17
O4	0.109	3.0	0.33	3.0	0.33
O5	0.109	3.0	0.33	3.0	0.33
Threats					
T1	0.116	-	-	-	-
T2	0.101	-	-	-	-
T3	0.101	-	-	-	-
T4	0.101	-	-	-	-
T5	0.087	-	-	-	-
Total	1.00				
Strengths					
S1	0.096	-	-	3.0	0.29
S2	0.096	-	-	3.0	0.29
S3	0.084	-	-	3.0	0.25
S4	0.084	-	-	3.0	0.25
S5	0.090	-	-	3.0	0.27
S6	0.078	-	-	2.0	0.16
Weaknesses					
W1	0.072	-	-	-	-
W2	0.078	-	-	-	-
W3	0.078	-	-	-	-
W4	0.090	-	-	-	-
W5	0.078	4.0	0.36	-	-
W6	0.072	-	-	-	-
Total	1.00		1.88		2.64

From the results of the QSPM calculation, it can be seen that the appropriate strategy for the utilization of the workshop and dormitory building at Construction Services Office Unit IV Surabaya is by improving a cooperation with external parties, such as Local Government, Construction Services Associations, Certified construction institution services, Contractors and Vocational Schools to regulate a construction training that utilizes workshop buildings and dormitories with a score of 2.64.

V. CLOSURE AND RECOMMENDATION

Based on the results of the research conducted, the strategy for utilizing a workshop and dormitory building to support construction training at Construction Services Office Unit IV Surabaya is to improve cooperation with external parties, such as Local Government, Construction Services Associations, Certified construction institution services, Contractors and Vocational Schools to implement a construction training that utilizes workshop buildings and dormitories and improving promotion activities by using information and communication technology such as website or social media and developed routine coordination forums with external parties.

The suggestions that can be given regarding to these matters in the future are the Construction Service Office Unit IV Surabaya can carry out further evaluation studies after the implementation of the strategy of utilizing the workshop and dormitory building to support construction training and conduct periodic research and studies to determine the development of strategies that should be used.

REFERENCES

Alkhafaji, Abbas F. (2004). *“The Art of Strategic Management Vol 8”*. Jaico Publishing House. Mumbai.

Anwar, N. & Supriyatna. (2003). Dasar Teori dan Pengembangan Aplikasi Manajemen Aset di Bidang Prasarana dan Sarana Publik. *Buletin Pendidikan Profesional*, Vol 1, No 5.

Barney, J. B., & Hesterly, W. (2008). *“Strategic Management and Competitive Advantage: Concepts and Cases”*. Upper Saddle River, New Jersey: Pearson Education, Inc.

Carn, N, R Black and J. Rabianski. (1999). Operational and Organisational Issue Facing Corporate Real Estate Executive and Managers. *Journal of Real Estate Research*, 17(3) : 281-299.

Clarence Valley Council. (2007). *Asset Management Strategy*. Version 1.03, August 2007. Jeff Roorda & Associates.

David, Fred. (2016). *Manajemen Strategik : Studi Pendekatan Keunggulan Bersaing Edisi ke-15*. Penerbit Salemba Empat. Jakarta.

Department of Treasury. (2004). *“Strategic Asset Management Framework”*. Government of Western Australia.

Fadjarwati, Nurlaila dan Koswara, Nandi. (2014). “Optimasi Pemanfaatan Aset Gedung Balai Pelatihan Kesehatan Dinas Kesehatan Provinsi Jawa Barat Melalui Strategi Pemasaran”. *Jurnal Orasi Bisnis Edisi ke-XI*. Hal. 11-21.

Fadjarwati, Nurlaila dan Pratami, Gia. (2014). “Strategi Fungsional pada Peningkatan Penggunaan Gedung Grha Wiksa Praniti”. *Jurnal Orasi Bisnis Edisi Vol. 12 No. 2*. Hal. 7-15.

Febriyanti, Wulan. (2016). “Efektivitas Program Pelatihan Perbengkelan Mobil, Dalam Meningkatkan Ketrampilan Mekanik pada Peserta Pelatihan di BPPNF Provinsi Banten”. *Jurnal E-Plus*, Vol. 1, No. 1, Hal 67-73.

Formisano, Roger A. (2004). *Manager’s Guide to Strategy*. The Mc Graw Hill Company. New York.

Griffin, Ricky W. (2004). *“Manajemen : Edisi Kesepuluh”*. Erlangga. Jakarta.

Hamalik, Oemar. (2011). *“Proses Belajar Mengajar”*. Bumi Aksara. Jakarta.

Jauch, Lawrence & Glueck, William. (2000). *“Manajemen Strategis dan Kebijakan Perusahaan”*. Penerbit Erlangga. Jakarta.

Juarti, Ery. RR Marlailana. (2015). “Penentuan Indikator Kinerja Bangunan Gedung Pendidikan”. *Jurnal Fondasi*. Vol. 4, No. 2. Hal 48-58.

Kadariusman, Evi Maria (2013). “Penerapan QSPM untuk Penentuan Alternatif Strategi pada STIE Malangkecewara Malang”. *Jurnal Manajemen dan Akuntansi*, Volume 2, Nomor 2, Agustus 2013. Hal. 35-49.

Kurniawan, Heru. (2016). *“Analisis Strategi dan Penentuan Tarif Dalam Peningkatan Pemanfaatan Gedung Balai Diklat Wilayah IV Surabaya”*. Tesis Magister Manajemen Aset Infrastruktur ITS Surabaya.

Mandala, Jultince, V. (2012). *“Optimalisasi Pengelolaan Laboratorium Lingkungan di Provinsi Nusa Tenggara Timur”*. Tesis Magister Manajemen Aset Infrastruktur ITS Surabaya.

Noordi, Haris. (2017). “Evaluasi Implementasi Pelatihan Kerja di Unit Pelatihan Teknis Balai Latihan Kerja Kabupaten Kapuas”. *Administras-Jurnal Ilmu Administrasi dan Manajemen*. Vol 2 No. 1. Hal. 33-40.

Rahmawati, Triana & Noor, Irwan. (2014). “Sinergitas Stakeholders Dalam Inovasi Daerah”. *Jurnal Administrasi Publik (JAP)*, Vol. 2, No. 4, Hal. 641-647.

Riduwan. (2010). *Metode dan Teknik Menyusun Tesis*. Penerbit Alfabeta. Bandung.

Robbins, Stephen, P & Judge. (2007). *Perilaku Organisasi : Edisi ke-12*. Penerbit Salemba Empat. Jakarta.

- Shimizu, Katsuhiko, (2012). *The Cores of Strategic Management. Routledge*. New York.
- Siregar, D.D. (2004). *“Manajemen Aset”*. PT Gramedia Pustaka Utama. Jakarta.
- Sugiana. (2013). “Konseptualisasi Model Strategi Pengelolaan Aset Fisik”. *Jurnal Bisnis dan Manajemen Aset* Vol 1. Oktober 2013. Halaman 85-107.
- Sulchan, Mohammad. (2007). *“Manajemen Pelatihan Kerja di Balai Latihan Kerja Industri (BKLI) Semarang”*. Tesis Manajemen Pendidikan Universitas Negeri Semarang.
- Supriyadi, Handono. (2005). *“Analisis Strategi Pelatihan pada Balai Latihan Kerja Industri Semarang dalam Memenuhi Permintaan Tenaga Kerja di Kota Semarang”*. Tesis Magister Ilmu Administrasi Publik Universitas Diponegoro Semarang.
- Susanthi, Putu Rani. (2017). *“Analisis Lingkungan Internal dan Eksternal dalam Mencapai Tujuan Perusahaan (Studi Kasus STIE Galileo Batam). Jurnal Elektronik Riset Ekonomi Bidang Manajemen dan Akuntansi REKAMAN*. Vol. 1, No. 1, November 2017.
- Wahyudi, Mudji. (2014). Studi Evaluasi Keaktifan SDM Konstruksi Teknisi/Tenaga Terampil di Provinsi Nusa Tenggara Barat. *Jurnal Spektrum Sipil*, Vol. 1, No. 1. Hal. 31-44.
- Wandrial, Son (2012). “Budaya Organisasi (Organizational Culture), Salah Satu Sumber Keunggulan Bersaing Perusahaan Di Tengah Lingkungan Yang Selalu Berubah”. *Jurnal Binus Business Review*, 03
- Williams, Kevan (2009). *“Strategic Management : Analyzing, Planning, Focus Prioriting, Monitoring”*. DK Publishing, New York.
- Yin, Robert K. (2014). *“Studi Kasus Desain & Metode”*. Rajawali Pers. Jakarta.

Redesign Intersection with Roundabout and Pedestrian Service Analysis at 0 Km Yogyakarta

1st Rizky Gusti Ranardi Putra
Faculty of Civil Engineering and Planning
Indonesian Islamic University
Indonesia
rizkygusti87@gmail.com

2nd Prima Juanita Romadhona
Faculty of Civil Engineering and Planning
Indonesian Islamic University
Indonesia
prima_dhona@uii.ac.id

Abstract—Malioboro Street is very well-known as a tourism area connects with 0 KM Yogyakarta. Unfortunately, the traffic jam often happened at the intersection of 0 KM. Since it is closed with the museum and the National Palace of Yogyakarta, there is a lot of pedestrian along the sidewalks. Hence, redesign of intersection and upgrade facilities of pedestrian were needed to improve the performance of the intersection. Using a traffic and pedestrian volume, vehicle speed, and driving behavior as primary data and VISSIM as the modeling tools, the comparative performance of before and after the redesign was found. As a result, roundabout gave better performance than an intersection with the signal at 0 KM area. Additionally, the compatible crossing facility for the intersection was pelican crossing

Keywords—VISSIM, Roundabout, Sidewalk, Crossing.

I. INTRODUCTION

Yogyakarta is one of the tourist areas in Indonesia. There are many tourist destinations in Yogyakarta, such as Malioboro Street. The high traffic on Malioboro Street often caused traffic jammed to Margamulya Street at 0 Km Yogyakarta Intersection. Furthermore, there was a pedestrian area in public open spaces at 0 km Yogyakarta. Previous research to plan a roundabout at 0 KM Yogyakarta Intersection showed better capacity and delay than the existing condition. However, this research analyzed without using modeling tools but Indonesia Highway Manual (Falahuddin 2018). Therefore, a previous study was to analyze 3 major roundabouts in Sunyani, Ghana and the results was the 3 roundabouts should be signalized to improve the performance (Agyeman et al. 2015). Additionally, the previous research about an existing roundabout in front of PAU building showed that existing geometry not eligible so this roundabout must be redesigned by enlarging the diameter of the roundabout (Nugraha and Malkamah 2013). Also, Radin Intan roundabout in Bandar Lampung showed that the delay of the three approaches was not good based on previous research (Darmawan et al. 2016). Moreover, the research about roundabouts safety benefits in Abu Dhabi found that vehicle speeds at Abu Dhabi roundabouts exceed as recommended by design guides in general and found that only 4.1% of the drivers understanding of the rules to driving at roundabouts (Dabbour et al. 2018). Also, a study that observe the inconsistencies of Australasian, EU, and US standards of roundabout. The results, in design standards are identified and recommendations for improvement (Montella et al. 2013). In addition, a previous study about roundabouts safety for the cyclist said that the size of central islands and type of bicycle facilities at single-lane roundabouts had considerable impacts

on cyclists' safety. Central island with diameters of 20–40 m was safer for cyclists than smaller or larger central island. A central island, which elevated 2 m in the middle or more above the circulating lane, was safer for cyclists than single-lane roundabouts with lower central islands. Single-lane roundabouts with separate cycle paths, where cyclists must yield to motorists entering or exiting the roundabout, were safer than roundabouts with cycle lanes. Single-lane roundabouts were safer for cyclists than intersections regardless of speed limits when these roundabouts have high central islands and/or separate cycle paths (Jensen 2017). However, it was a research to check the compatibility of HCM equations for determining the entry capacity of a four-legged roundabout under mixed traffic condition and the results may use for planning of roundabout under mixed traffic flow condition (Mathew et al. 2017). In the other hand, it was a research about primary school students as pedestrians on their journeys to school and the results were pedestrian space capacity with consideration to the number of children in a walking group and straight and zig-zag movement pattern. There was a need to have a special child pedestrian standard for the urban and rural area (Makalew et al. 2018). Also, previous research to analyze the public perception of using pedestrian and public space area in Jakarta shows that the city life activities require space for pedestrian adapted to the aspirations of its people, as an effort to humanize pedestrians into the pedestrian area planning as a spatial dimension in urban area physical development (Uniaty 2017). Additionally, Ngarsopuro night market area was one of the shopping centers crowded by the pedestrian. Therefore, the research showed that the level of service of the pedestrian was D which does not meet the standards (Prasetyaningsih 2010). However, there was previous research was about pedestrian behavior using the crossing facilities in the Malioboro area and the results of this research explained that various pedestrian behaviors in using crossing facilities in aspects of security, safety, and comfort were the same as the conditions of existing pedestrian facilities (Trianingsih and Hidayah 2014). Therefore, the aim of this research was to find the right solution to solve high traffic problem on 0 KM Yogyakarta Intersection.

II. PTV VISSIM

VISSIM (Verkehr In Stadten – SIMulationsmodell) is the multimodal transport microscopic simulation software developed by PTV Planung Transport Verkehr AG in Karlsruhe, Germany. This program can analyze personal operations and public transportation such as regulating lanes,

vehicle compositions, traffic signal, vehicle composition, etc. So that it can become a tool used for alternative transportation and improve effective transportation planning.

The template is used to format your paper and style the text. All margins, column widths, line spaces, and text fonts are prescribed; please do not alter them. You may note peculiarities. For example, the head margin in this template measures proportionately more than is customary. This measurement and others are deliberate, using specifications that anticipate your paper as one part of the entire proceedings, and not as an independent document. Please do not revise any of the current designations.

III. DELAY

Delay is additional time needed to go through an intersection. Based on the delay, the level of service is divided into 6 (Minister of Transportation 2015) as follows:

- Level of Service A, the delay is less than 5 seconds
- Level of Service B, the delay is 5 to 15 seconds
- Level of Service C, the delay is 15 to 25 seconds
- Level of Service D, the delay is 25 to 40 seconds
- Level of Service E, the delay is 40 to 60 seconds
- Level of Service F, the delay more than 60 seconds

IV. TYPE OF ROUNDABOUTS

The type of roundabouts can be seen in Table I.

TABLE I. TYPE OF ROUNDABOUT (DIRECTORATE GENERAL OF HIGHWAYS 1997)

Type of Round about	Radius of Roundabouts (m)	Number of Entry Lanes	Width of Entry Lane (m)	Distance Between Lane (m)	Width Between Lanes (m)
R10-11	10	1	3,5	23	7
R10-22	10	2	7,0	27	9
R14-22	14	2	7,0	31	9
R20-22	20	2	7,0	43	9

V. PEDESTRIAN

Average Flow Level of Service for Sidewalks can be seen in Table II.

TABLE II. LEVEL OF SERVICE FOR SIDEWALKS (MINISTER OF PUBLIC WORKS REGULATION 2014)

Level of Service	Space (m ² /p)	Speed (m/min)	Flow Rate (p/m/min)	v/c Ratio
A	≥12	≥78	≤6,7	≤0,08
B	≥3,6	≥75	≤23	≤0,28
C	≥2,2	≥72	≤33	≤0,40
D	≥1,4	≥68	≤50	≤0,60
E	≥0,5	≥45	≤83	≤1
F	<0,5	<45	Variable	1

Volume/Capacity Ratio can be measured by making the assumption that the capacity of the pedestrian line is 75

people/minute/meter. The pedestrian sidewalk's width according to the usage of the area can be seen in Table III.

TABLE III. THE PEDESTRIAN SIDEWALK'S WIDTH TO USAGE OF AREA (MINISTER OF PUBLIC WORKS REGULATION 2018)

Area Application	Minimum Width (m)	Recommended Width (m)
Housing	1,6	2,75
Office Complex	2	3
Industry	2	3
School	2	3
Terminal/Bus stop	2	3
Shopping Complex/Entertainment	2	4
Bridge/Tunnel	1	1

If the need of pedestrian sidewalk is above minimum width provision (W) then the measurement can be done by using the volume of planned pedestrian (P) which is average volume per minutes in the peak hour. The width of the pedestrian sidewalk can be measured using a formula as follows.

$$W = \frac{P}{35} + n \tag{1}$$

Explanation:

- P = Pedestrian Volume (person/minute/meter)
- W = Width of Pedestrian Sidewalk (meter)
- n = Additional Width (meter)

Following formulas can be used to find the crossing facility used by a pedestrian.

$$P \cdot V^2 \tag{2}$$

Explanation:

- P = The flow of pedestrians who cross the street by 100m per hour (person/h)
- V = The traffic flow of the two directions per hour (vehicle/h)

Value of V and P are the average flow of pedestrian and vehicles in the 4 hours busy times. According to the value of PV², below are the recommendation of the type of crossing facilities.

TABLE IV. RECOMMENDATION OF TYPE OF CROSSING FACILITIES (MINISTER OF PUBLIC WORKS REGULATION 2018)

PV ²	P	V	Recommendations
> 10 ⁸	50 – 100	300 – 500	Zebra Cross (Zc)
>2 X 10 ⁸	50 – 1100	400 - 750	Zc With Central Island
>10 ⁸	50 – 1100	>500	Pelican Crossing (p)
>10 ⁸	> 1100	>500	Pelican Crossing (p)
>2 X 10 ⁸	50 – 1100	>700	Pelican with Central Island
>2 X 10 ⁸	> 1100	>400	Pelican with Central Island

VI. RESEARCH METHODS

The type of road crossing can be as follows.

A. Zebra Cross

- 1) Installed on the street with or without traffic sign.
- 2) If an intersection is set with traffic light the time given for pedestrian crossing the street is also set by the traffic light.
- 3) If an intersection is not set with traffic light then the vehicle's speed limit is below 40 km/h.

B. Pelican Crossing

- 1) Pelican Crossing is installed on the street with a minimum of 300 meters from intersection or
- 2) On the street with average operational traffic speed above 40 km/h.

Systematically, this research was done in several steps. First, identified the problem that will be explored. Then, looking for literature studies and references related to research. After that, determined the data needed, both primary data such as vehicle volume, pedestrian volume, road geometry, pedestrian path geometry and secondary data such as peak hour from previous research. Then, this research was used the Indonesia Road Capacity Manual (Minister Of Public Works Regulation 2018) to determine the size of the roundabout. After that, analyzed both data with PTV VISSIM software to make a model of existing condition, the alternative proposals, and to analyze pedestrian facility (Minister of Transportation 2015, Minister of Public Works Regulation 2014 and Minister Of Public Works Regulation 2018). Lastly, the discussion of the data analysis is required to find out the results of the research and conclusion. The existing layout of traffic facilities and pedestrian facilities can be seen in Fig. 1.

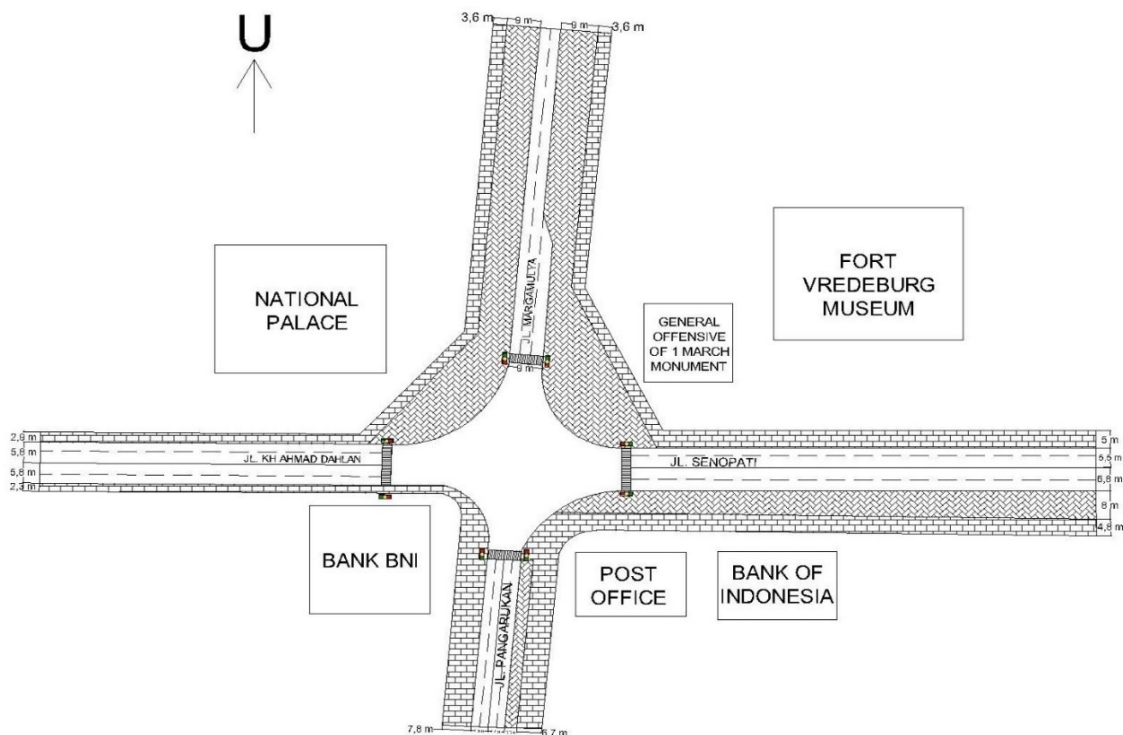

Fig. 14. The Existing Layout of Traffic Facilities and Pedestrian Facilities at 0 KM Yogyakarta

VII. ANALYSIS

The survey showed that vehicle volume in peak hours on Monday, September 10th, 2018 at 17.00-18.00 with a volume of 9056 vehicle/hour which can be seen in Table V as follows.

TABLE V. VEHICLE DISTRIBUTION AT PEAK HOURS

Approach	Straight			Right Turn			Left Turn			Total
	M	L	H	M	L	H	M	L	HV	
	C	V	V	C	V	V	C	V		
(vehicle/h)										
North	84	13	0	71	16	9	68	2	8	2851
East	15	33	16	0	0	0	46	8	8	2436
South	0	0	0	49	12	2	97	2	0	1824
West	14	25	11	21	27	0	0	0	0	1945
Total										9056

The pedestrian survey shows that pedestrian volumes were obtained at peak hours per segment and pedestrian who cross the street per approach can be seen in Table VI and Table VII as follows.

TABLE VI. PEDESTRIAN VOLUME DATA AT PEAK HOURS

Segment	Number of Pedestrians
North-East	2610
East-South	1375
South-West	479
West-North	1061

From Table 6, the highest pedestrian volume was North-East segment and the lowest pedestrian volume was South-West segment.

TABLE VII. THE VOLUME OF PEDESTRIAN WHO CROSS THE STREET

Segment	Number of Pedestrians Who Cross the Street
Margamulya Street	196
Senopati Street	952
Pangarukan Street	134
K.H Ahmad Dahlan Street	535

From Table 7, the highest pedestrian who cross the street was in Senopati street and the lowest pedestrian was in Pangarukan street.

The results of an analysis of pedestrian facilities are reported in Table VIII and Table IX.

TABLE VIII. ANALYSIS OF PEDESTRIAN SIDEWALK WIDTH

Approach	v (p/min/m)	c (p/min/m)	W (m)	v/c
North	43,5	75	2,24	0,58
East	22,9	75	1,65	0,3
South	7,98	75	1,22	0,1
West	17,68	75	0,23	0,23

From Table VIII, the best volume/capacity ratio was South approach and the worst was North approach.

TABLE IX. ANALYSIS OF PEDESTRIAN CROSSING FACILITIES

Approach	P	V	PV ²
North	196	2150	9,06 X 10 ⁸
East	952	5739	3,14 X 10 ¹⁰
South	134	3451	1,6 X 10 ⁹
West	535	5127	1,41 X 10 ¹⁰

VIII. DISCUSSION

A. Delay Result

The results of the delay results comparison can be seen as in Fig. 2.

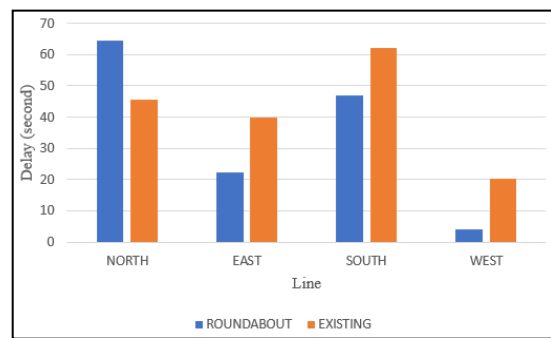

Fig. 15. Comparison of Delay Results of Existing Intersection and Roundabout

From Fig. 2, most of the approach using roundabout had a better delay than the intersection with the existing condition. There was only the north approach that had worse delay than the existing condition.

B. Queue Counter

The results of the queue counter comparison described in Fig. 3.

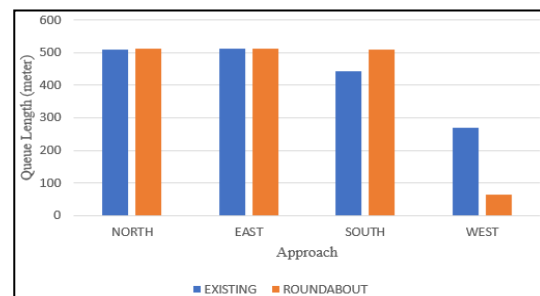
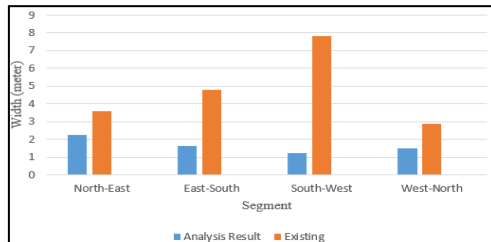

Fig. 16. Comparison of Queue Counter of Existing Intersection and Roundabout

From Fig. 3, the queue length for the north approach existing condition was shorter around 3,69 m than with a roundabout. For the east approach, the existing condition was shorter around 1,29 m than with a roundabout. For the south approach, existing condition was shorter around 67,9 m than with a roundabout. For the west approach, roundabout was shorter around 206,86 m than existing condition.

Also, the level of service of each approach was obtained based on the delay that can be seen in Table X and the comparison of the queue length which can be seen in Table XI as follows.

TABLE X. LEVEL OF SERVICE OF EACH APPROACH BASED ON DELAY



Approach	Delay				
	Existing (sec)	LOS	Roundabout (Second)	LOS	Difference
North	45,61	E	64,53	F	-41%
East	39,85	D	22,34	D	+43%
South	62,22	F	46,98	E	+24%
West	20,35	C	4,13	A	+79%

Based on Table X, the level of service at existing condition in the north approach was E and then decreases by 41% to F with the roundabout. Level of service at existing condition and using roundabout in the east approach was D but then increased 43% with a roundabout. Level of service existing condition in the south approach was F and then increased 24% to E with a roundabout. Level of service existing condition was C and then increased 79% to A with a roundabout.

TABLE XI. QUEUE LENGTH OF EACH APPROACH

Approach	Queue Length (m)		
	Existing	Roundabout	Difference
North	508,66	512,35	-0,7%
East	510,99	512,29	-0,25%
South	441,38	509,35	-15,39%

Based on Table XI, the highest improvement was the West approach and the worst performance was the North approach.

C. Pedestrian Facilities

The comparison of the width of the existing sidewalk and the results of the analysis that can be seen in Fig. 4. The level of service of the pedestrian facility can be seen in Table 12 and the results of analysis of crossing facilities with existing crossing facilities which can be seen in Table XIII.

Fig. 17. Comparison of Sidewalk Width of Analysis and Existing Sidewalks

From Fig. 4, all the existing sidewalk widths at 0 Km Yogyakarta Intersection were greater than the results of the analysis.

TABLE XII. LEVEL OF SERVICE OF PEDESTRIAN FACILITY

Sidewalk	Flow Rate (p/m/min)	v/c Ratio	Level of Service
North-East	43,5	0,58	D
East-South	22,9	0,3	C
South-West	7,98	0,1	B
West-North	17,68	0,23	B

From Table XII, the best performance was the South-West segment and the worst performance was the North-East segment.

TABLE XII. PEDESTRIAN CROSSING FACILITIES

Approach	P	V	PV ²	Recommendations
North	196	2150	9,06 X 10 ⁸	pelican crossing
East	952	5739	3,14 X 10 ¹⁰	pelican crossing
South	134	3451	1,6 X 10 ⁹	pelican crossing
West	535	5127	1,41 X 10 ¹⁰	pelican crossing

From Table XIII, all crossing facilities at 0 Km Yogyakarta Intersection were recommended to change from zebra crossing to pelican crossing based on [Minister of Public Works 2018]. Unfortunately for KH. Ahmad Dahlan street and Pangarukan street could not be installed pelican crossing since on both streets there was another intersection before 300 meters. The layout of traffic facilities and pedestrian facilities plan can be seen in Fig. 5.

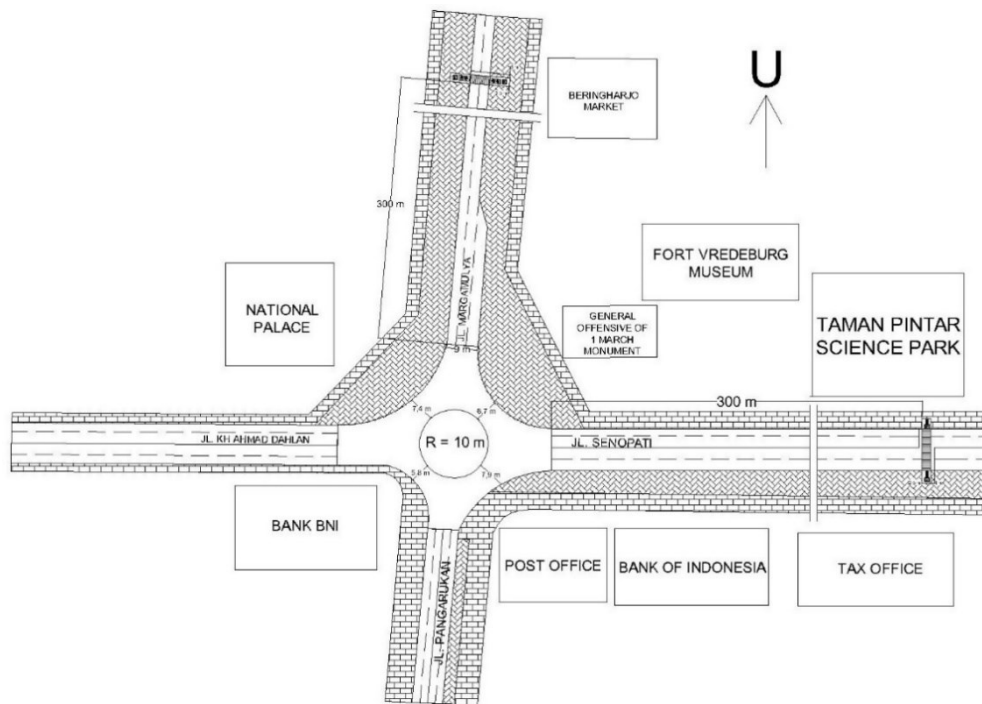

Fig. 18. The Design Layout of Roundabout and Pedestrian Facilities at 0 Km Yogyakarta

IX. CONCLUSIONS AND SUGGESTIONS

A. Conclusions

1) Using roundabout in 0 KM Yogyakarta Intersection gave a better value of delay than the existing condition on most approach. However, there was only north approach that has a worse delay with roundabout than before.

2) The sidewalk facilities at 0 Km Yogyakarta Intersection has the best performance in South-West segment and the worst performance in North-East segment. Crossing facilities that suitable to be installed on Margamulya street and Senopati street was Pelican crossing. However, KH Ahmad Dahlan street and Pangarukan street cannot be installed pelican crossing because on both streets there was another intersection before 300 meters.

B. Suggestions

1) Future research can be developed for pedestrian safety and comfort such as make an overpass for the pedestrian.

2) Research can be developed to look for alternative types of intersections or traffic engineering such as from 2 directions traffic to 1 direction in order to make 0 Km Yogyakarta Intersection less dense.

REFERENCES

F. Falahuddin, "Evaluasi dan desain ulang Simpang 0 KM Yogyakarta dengan bundaran," unpublished, 2018.
 S. Agyeman, H. Abeka, and S. B. Asiedu, "Capacity and performance analysis of 3 roundabouts in Sunyani," *International Journal of Science and Research*, vol. 4, pp. 219-230, Oktober 2015.
 H. A. Nugraha and S. Malkamah, "Evaluasi dan perancangan ulang geometri bundaran yang mempertimbangkan aspek keselamatan dengan kondisi Jalan Kaliurang ditutup," unpublished, 2013.

W. I. Dharmawan, D. Oktarina, and H. Syahroni, "Analisis kinerja bundaran menggunakan metode Manual Kapasitas Jalan Indonesia (MKJI)," *Jurnal Teknik Sipil*, vol. 12, pp. 99-181, Oktober 2016.
 E. Dabbour, M. Al Awadhi, M. Aljarah, M. Malak, and M. Haider, "Evaluating safety effectiveness of roundabouts in Abu Dhabi," *IATSS Research*, vol. 42, pp. 274-283, April 2018.
 A. Montella, S. Turner, S. Chiaradonna, and D. Aldridge, "International overview of roundabout design practices and insight for improvement of the Italian Standard," *Canadian Journal of Civil Engineering*, vol. 40, pp. 1215-1226, December 2013.
 S. U. Jensen, "Safe roundabouts for cyclist," *Accident Analysis and Prevention*, vol. 105, pp. 30-37, August 2017.
 S. Mathew, A. Dhamaniya, S. S. Arkatkar, and G. Joshi, "Roundabout capacity in heterogeneous traffic condition: modification of HCM equation and calibration," *Transportation Research Procedia*, vol. 27, pp. 985-992, September 2017.
 F. P. Makalew, S. A. Adisasmita, S. Wunas, and S. H. Aly, "Pedestrian space capacity and movement pattern for elementary students in urban and rural area," *International Journal of GEOMATE*, vol. 15, pp. 63-69, Oktober 2018.
 Q. Uniaty, "Pedestrian space characteristics analysis on Kyai Tapa-KH. Hasyim Ashari street corridor West Jakarta," *Aceh International Journal of Science and Technology*, vol. 6, pp. 153-165, December 2017.
 I. Prasetyaningsih, "Analisis karakteristik dan tingkat pelayanan fasilitas pejalan kaki di kawasan pasar malam Ngarsopuro Surakarta," unpublished, 2010.
 L. Trianingsih, R. Hidayah, "Analisis perilaku pejalan kaki pada penggunaan fasilitas penyeberangan di sepanjang jalan kawasan Malioboro Yogyakarta," *Inersia*, vol. 10, pp. 106-121, December 2014.
 Minister of Transportation, "Guidelines for implementing management and traffic engineering activities," vol. 96, 2015.
 Directorate General of Highways, "Indonesian Road Capacity Manual," 1997.
 Minister of Public Works Regulation, "Guidelines for planning, provision and utilization of pedestrian network infrastructure and facilities in urban areas," vol. 03, 2014.
 Minister of Public Works Regulation, "Pedestrian facilities technical planning," vol. 2, 2018.

Analysing Risk for Sustainable Construction Project Using Fuzzy logic: A Concept

1st Sony Susanto
Institut Teknologi Sepuluh Nopember
(ITS), Department of Civil
Engineering,
Surabaya, Indonesia, E-mail;
santony5@gmail.com

2nd I Putu Artama Wiguna
Institut Teknologi Sepuluh Nopember
(ITS), Department of Civil
Engineering,
Surabaya, Indonesia, E-mail;
artama.wiguna@gmail.com

3rd M. Arif Rohman
Institut Teknologi Sepuluh Nopember
(ITS), Department of Civil
Engineering,
Surabaya, Indonesia, E-mail;
arif.its@gmail.com

Abstract— *The use of natural resources is widely used in construction operations, as well as in the operation of a building resulting from a construction project there is still a lot of energy that cannot be maximally utilized to reduce energy use so that sustainable concepts can be implemented properly. In implementing sustainable construction there are still many risks faced by contractors, clients, and regulations. Therefore, a risk analysis of sustainable construction projects is needed to reduce negative impacts and improve the implementation of sustainable construction in reducing energy use, so that sustainable construction can be implemented smoothly in Indonesia. In assessing the risks to a sustainable construction project there is still few research done, it requires risk modeling that takes into account sustainable factors. The Identification of risk for sustainable construction projects is obtained from the literature review. While the assessment model is determined by considering 3 sustainable aspects (economic, social, environmental) approach to probability and impact. With regard to probability and impact, the ambiguity of human judgment is assessed, using fuzzy. The results of the concept found in the formula for assessing the risk of sustainable construction projects are $Rsp = (Rec + Rso + Ren) / 3$.*

Keywords— Sustainable Construction Projects, Fuzzy Logic, Sustainable construction project formulas

I. INTRODUCTION

Activities related to construction projects are inseparable from the use of surrounding natural resources. Natural resources that are used continuously will need needs in the future, the unused needs of natural resource needs will be depleted. Project life cycle about the use of natural resources from planning, then designing, construction, operation, maintenance until deconstruction will consume natural resources and produce large amounts of waste (Abduh and Fauzy, 2012). This encourages current construction practices in the development of maximum savings and the use of natural resources, thus giving rise to various sustainable concepts with sustainable construction, green buildings and high buildings (Apine, 2016).

The concept of sustainability in this project raises different understandings so that some writers in the literature use terms that do not discriminate between the terms that occur. The concept of sustainability discussed is about ecological, social and economic. In defining it, sustainable construction is designed to be created and developed in this environment that is provided with resources and ecological design (Apine, 2016).

Green building, which is part of the ongoing project stages in Indonesia, is a form of good sustainable construction implementation. The green building concept is the application of sustainable construction by carrying out maximum efficiency in the use of water, energy, design, by developing environmentally friendly discoveries (Apine, 2016).

In construction projects, there are activities that have a lot of influence on the environment. These activities can have negative impacts such as reduced free land, use of materials obtained from natural resources, use of heavy equipment and transportation equipment during the construction that impacts pollution. So the project team is needed to carry out the concept of sustainable construction in the project, the term used in the project is known as green construction (Koe et al., 2014).

Projects carried out in Surabaya, in general, have implemented the concept of sustainable construction well, but there are still some things that need to be considered so that the implementation of work can run well (Koe et al., 2014). There are some challenges in realizing a green building that has resulted in slow implementation in Indonesia. Two biggest challenges have been defined in the previous literature, namely the lack of demand and interest from clients, and the lack of knowledge of green buildings. (Abduh and Fauzy., 2012)

There are several other challenges that make it difficult for company owners to take a project that implements sustainable construction, including (1) Increasing costs compared to conventional/ conventional projects; (2) Lack of communication and desire between project team members; (3) Lack of research capable of convincing project owners; (4) Lack of client interest. So that the challenge requires solutions in terms of greater communication in the project team, integrated environmental management to reduce negative impacts on the surrounding environment, use of more efficient new construction materials, periodic increase in work training for workers (Hwang and Tan, 2012).

Besides, in its implementation, it can also have negative effects on safety related to technology, implementation, and products. Examples in Occupation are the height for the installation of photovoltaic panels using skylights / special tools in the mountains. Such work can have major risks such as falling, burning skin, electrocution, which can cause death (Kleiner, 2013)

Due to the challenges above, every new ingredient and application used in the field, the risk will also grow. Risk management is needed in managing risk on sustainable

projects that can cause negative impacts on the environment in its development. so as not to have a wider impact (Apine, 2016). Some research on the challenges and barriers to sustainable construction have been done but still a bit of research analyzing the risks and impacts and mitigation should be done so that sustainable construction can be applied, while risk in sustainable construction also varies (Hwang et.al 2017)

Several studies on risk analysis projects that have been done previously that use a variety of different methodologies. Some of these studies use analysis of reliability and validity (Darda et al., 2014), one way anova (Ismael et al., 2014), mean (Hwang et al., 2017), methods of probing and impact. The above method has limitations because it is certain and invalid for other purposes or even for the same purpose in other groups, for the mean weaknesses are very sensitive to large amounts of data. If a lot of extreme data, on average being less representative (representative) cannot be used for qualitative data, it is not suitable for diverse data, while the multiplication of possibilities and impacts for ranking risk in general.

Study, the technical research methodology used to determine the level of risk is the Fuzzy Logic technique. This technique began to be applied in the sustainability assessment. This technique is able to represent data that is uncertain, able to represent human thinking and handle situations that are not clear (Andriantiatsaholiniaina, 2004). Fuzzy techniques use many indicators to analyze risk factors that have been prepared, subjects are treated with fuzzy logic in handling ambiguity, subjectivity, and inaccuracy in human reasoning when processing large and complex volumes of data. Sustainable has linguistic variables (rare, high, etc.) for probability and impact will have meaning that always depends on the context. Example, high impact will have different meanings for each company condition and construction project environment. Then the fuzzy logic method is very appropriate to use in risk analysis methods on sustainable construction projects

Based on the problems and previous research, this study is conducted to identify risks according to the literature review and model conceptually, analyze risks for sustainable construction projects.

II. LITERATURE REVIEW

A. Project Risk Management

Risk management is one of the most important in activities/activities reducing the risk that will / ever occur before. Then an understanding of risk management is needed to estimate any action before the activity will be carried out (PMI, 2013)..

Project risk is a condition or event that is expected to occur on a project, either a positive or negative impact on quality, cost, scope (PMI, 2013)..

Project risk management is the process of identifying risk, analysis, response, up to the control process throughout the project phase that aims to determine the actions to be taken in reducing the level of risk at high levels to lower risk levels (PMI, 2013).

B. Sustainable Construction Project

With the development of environmentally friendly technologies that are increasingly developing, some issues

arise in sustainability starting from the concept, facilities, and environmentally friendly buildings. (Apine, 2016). The term is known as sustainable construction, namely the concept of maximizing the use of natural resources by taking into account social, economic and ecological designs. This makes a difference in the way in which few stakeholders apply sustainable construction to reduce something that is not useful (Ismael et al 2018) and contracts that can be detrimental ((Darda et al., 2014)

One of the terms in carrying out sustainable construction that is aimed at its facilities is called a green building. This facility is known when the construction process takes place, while the tall building is the terminal building that has been completed after passing the phase of the project. (Apine, 2016)

According to Hwang et al., 2017 and Apine 2016 the construction industry in developed countries is one of the largest sources of consumption in the world, this allows an opportunity to implement sustainable construction. By doing so, it is expected that the use of world energy consumption can be used optimally and things that are not useful can be reduced, so that it will have a positive impact sustainably in the future (Apine, 2016).

The application of sustainable construction pays attention to 3 basic aspects, namely environmental, social and economic impacts. These three impacts are combined in quality and architectural design.

Another term in sustainability is green construction. Green construction is a construction process by emphasizing saving and maximizing effective use starting from the design, construction and operation phases in the project (Abduh and Fauzy, 2012, apine 2016). In connection with this definition, green construction is also called sustainable construction.

Some things to consider in implementing Green Construction (Koe et.al., 2014):

Safe supply for workers and prioritizing competent local staff, The project cycle is not too far away and Material Storage is maintained, Site layout project while maintaining the environment in the project area, Construction Waste Management, Providing a Healthy Work Environment, f. Selection and Operation of Construction Equipment.

III. METHODOLOGY

Regarding the definition of sustainable construction to pay attention to environmental impacts, social and economic conditions, the concepts in the methodology used in this research concept are probability x economic impact, probability x social impact, environmental impact. The concept can be seen in the research flow chart below, as follows using the fuzzy logic method;

3.1. Research Flow Chart

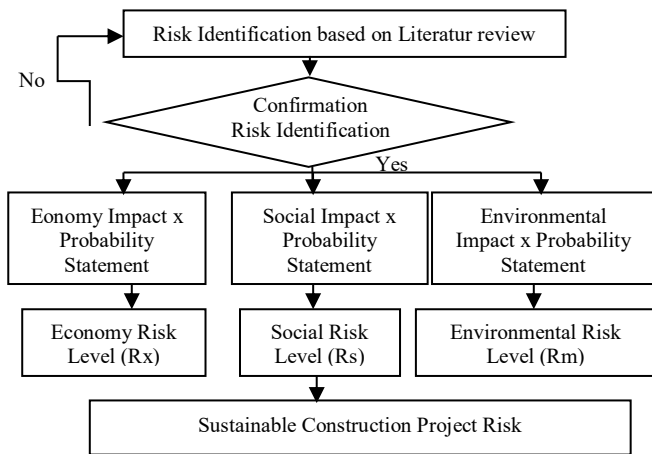

Fig. 1. Concept of Research Flow Chart

The first step in deciding the concept of this research is identification according to the literature review. The second is confirmation to determine the appropriate risk by the expert. Third, using fuzzy logic methodology. In the fuzzification process to get fuzzy input to determine the impact, probability in economic, social and environmental aspects. Then the inferen process to determine fuzzy rules. The last step in the defuzzification process to determine the level of risk in each aspect. After assessing the level of risk, the average merging of all three aspects to obtain the level of risk in sustainable construction project.

IV. RESULT & ANALYSIS

In this section will be discussed determining risk identification how sustainable construction project will be analyzed. The determination of those concepts also consider sustainable aspects (economic, social and environmental).

A. Analysis

A.1 Risk Identification

Risk identification on sustainable construction project are summarized as follows table 3. Table Risks in Sustainable Construction Projects.

B. Data Analysis

In this study, risk analysis uses fuzzy techniques to analyze risk variables that have been prepared, subjects are treated with fuzzy logic in handling ambiguity, subjectivity, and inaccuracy in human reasoning when processing large and complex volumes of data. Fuzzy stages include:

B.1. Fuzzification

Fuzzification input data is done to change input which has definite truth values (crisp input) into the fuzzy input form. Fuzzification is the process of converting a crisp number into a membership value in a fuzzy set

The intention above is the fuzzification process to determine the membership function by using a third type to provide more precise description and get more accurate results. In the fuzzy triangle set if it has 3 parameters,

namely: a, b, and R with a < b < c, explained by S (x, a, b, c) using the rule :

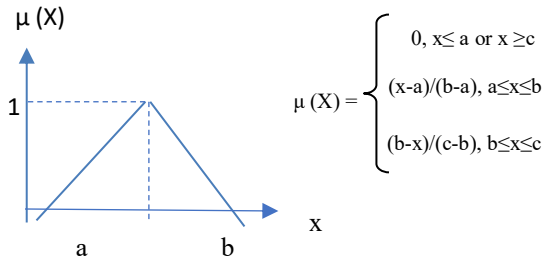

Fig. 2. Triangle Functions (Setiawan et al, 2008)

In this study, the membership function of linguistic terms is characterized by triangular fuzzy numbers. This below will be explained the probability categories, impact categories and forms of member functions, as follows;

B.1.1 Risk Probability Levels on Member Functions

The scale of assessment of the frequency of occurrence and the impact is adopted from the literature are used. On the explanation of probability used in the aspects of economic, social and environmental impact is the same statement, while at the same time impact is different statement.

TABLE I. PROBABILITY OF A RISK THAT OCCURS (Pavloff et al., 2009)

Numerically	Rating	Explanation
1-2	Rare	Rare, very unlikely to occur over a period of three years.
3-4	Unlikely	May occur in a three year period.
5-6	Moderate	May occur at least once every three years.
7-8	Most likely	To occur at least once every three years.
9-10	Almost Certain	Almost certainly will happen several times over a three-year period.

This bellow description membership function on the probability of risk.

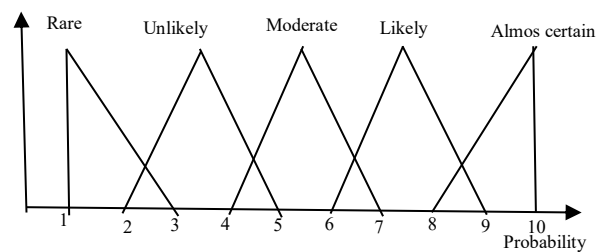

Fig. 3. Member Function at Risk Probability

The talk of the risk probability variable model above is 1-10, with fuzzy set domains: Rare (1-3) with the highest membership degree (= 1) in number 1, Unlikely (2-5) with the highest membership degree (= 1) in number 3.5, Moderate (4-7) with the highest degree of membership (= 1) in 5.5, Likely (6-9) with the highest degree of membership (= 1) in numbers

7.5 and almost certain (8-10) with membership degrees (= 1) highest at number 10.

This below description the probability range 1-10;

TABLE II. RANGE OF PROBABILITY 1-10

Likelihood	Range Likelihood 1-10										Range
	1	2	3	4	5	6	7	8	9	10	
Rare	█	█	█								1-3
Unlikely		█	█	█	█						3-5
Moderate				█	█	█	█				4-7
Likely						█	█	█	█		6-9
Almost Certain								█	█	█	8-10

Based on literature review, risk identification on sustainable construction project are summarized as follows;

TABLE III. TABLE RISKS IN SUSTAINABLE CONSTRUCTION PROJECTS.

Code	risk	Source (Hwang et.al, 2017)	Source (Ismael et al, 2018)	Source (Pavloff, et al 2009)	Source (Darda et al., 2014)	Source (Apine, 2016)
A	Finance					
A1	High cost of sustainable materials and equipment		√			
A2	Investor does estimate high sustainability funds		√			
A3	sustainable building shipments that have an impact on project costs and schedules					√
B	Maintenance / Legal Standards					
B1	Many green standards are currently voluntary; not required by law			√		
B2	Changes in Green Building Policy	√				
B3	Pollution Restriction	√		√		
B4	Import / eksport restrictions	√				
C	Performance					
C1	Product performance and reliability			√		
C2	Use of untested materials, unknown quality of green ingredients.			√		
C3	Impact of post-construction or sustainability operations and Performance			√		
C4	Concerns Green certification will be seen as a proper building code and good development practice.			√		
D	Consultants, Subconsulters & Subcontractors					
D1	Contractors and subcontractors agree to standards that are not in their control.			√		
E	Regulatory					
E1	The risk of regulatory demands becomes a punishment; if regulations become an integral part of the meaning of being green, there is a potential direct economic impact on business.			√		
E2	Risk that green regulations increase as the number of providers of green products and services increases			√		
F	Technology					
F1	lack potential technological sophistication and experience of certain team members	√	√	√	√	
F2	Not familiar with new technology	√				
G	Labor and Material Equipment					
G1	Lack of availability of green materials and equipment	√	√			
G2	Materials and equipment are easily damaged / temporary					√

This figure bellow about specified impact membership function;

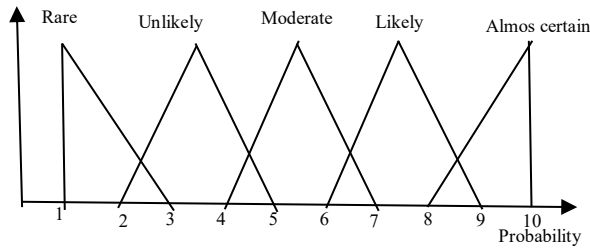

Fig. 4. Member Function at Impact Risk

The talk of the risk impact variable model above is 1-10, with fuzzy set domains: Rare (1-3) with the highest membership degree (= 1) in number 1, Unlikely (2-5) with the highest membership degree (= 1) in number 3.5, Moderate (4-7) with the highest degree of membership (= 1) in 5.5, Likely (6-9) with the highest degree of membership (= 1) in numbers 7.5 and almost certain (8-10) with membership degrees (= 1) highest at number 10.

Due to the level of Membership function of modelling the impact and probabilitas about the economic, social, environment is the same, then the formation of a membership function in describe as follows in the formula;

$$\begin{aligned}
 \mu \text{ very low} &= \begin{cases} 0 & s \leq 1 \\ (3-s)/2 & 1 \leq s \leq 3 \end{cases} \\
 \text{low} &= \begin{cases} 0 & s \leq 2 \text{ atau } s \geq 3,5 \\ (s-2)/2, & 2 \leq s \leq 3,5 \\ (5-s)/2, & 3,5 \leq s \leq 5 \end{cases} \\
 \mu \text{ moderate} &= \begin{cases} 0 & s \leq 4 \text{ atau } s \geq 5,5 \\ (7-s)/2, & 4 \leq s \leq 5,5 \\ (s-4)/2, & 5,5 \leq s \leq 7 \end{cases} \\
 \mu \text{ Major} &= \begin{cases} 0 & s \leq 6 \text{ atau } s \geq 7,5 \\ (s-6)/2, & 6 \leq s \leq 7,5 \\ (7,5-s)/2, & 7,5 \leq s \leq 9 \end{cases} \\
 \mu \text{ Disaster} &= \begin{cases} 0 & s \leq 8 \\ (s-8)/2, & 8 \leq s \leq 10 \end{cases}
 \end{aligned}$$

B.2 Inferent

In determining fuzzy rules to get risk level output can use the frequency and impact table below, while the risk

flow using fuzzy techniques can be seen the risk flow scheme to get a risk rating.

TABLE IV. FREQUENCY AND IMPACT RISK LEVEL (Pavloff et.al, 2009)

Potential Impact	Disaster	10	M	M	M	M	H	H	H	H	H	
		9	M	M	M	M	H	H	H	H	H	
	Major	8	M	M	M	M	M	M	H	H	H	
		7	M	M	M	M	M	M	H	H	H	
	Moderate	6	L	L	M	M	M	M	H	H	H	
		5	L	L	M	M	M	M	H	H	H	
	Low	4	L	L	L	L	M	M	M	H	H	
		3	L	L	L	L	M	M	M	H	H	
	Very Low	2	L	L	L	L	L	L	M	M	H	
		1	L	L	L	L	L	L	M	M	H	
			1	2	3	4	5	6	7	8	9	10
			Rare		Unlikely		Moderate		Likely		Almost Certain	
			Likelihood									

Note: H - Height; M - Height; L - Low.

This bellow explanation of definition the risk level

TABLE V. RISK FACTORS (Asmarantaka, 2014)

Categories	Handling Steps
High Risk Risk	reduction should be made at a lower level
Medium Risk	Steps for Handling in a certain period
Low Risk	Improvement step if possible

examples

Based on the above matrix values, the following 2 of logical rules are used as follows;

Rules (A): IF LIKELIHOOD ALMOST CERTAIN AND IMPACT CATASTROPHIC THEN RISK IS HIGH;

Rule (B): IF LIKELIHOOD LIKELY AND IMPACT MAJOR THEN RISK IS MEDIUM;

B.3 Defuzzification

This study uses the Defuzzy Weighted Average method commonly used. This method gives an average, weighted by the level of truth, from the support values in which all membership functions. Defuzzification converts the fuzzy output to crisp value. This method takes the weighted average value in the form of membership degrees so that z* can be defined as follows:

$$z^* = \sum \frac{a_i \cdot z_i}{a_i} \text{ (kusumadewi, 2010)}$$

where z is the crisp / rule value and a is the fire strength for each rule

C. Results.

The research concept uses the fuzzy logic methodology. The first step in this fuzzification process is to do fuzzy input to determine the same probability information on economic, social and environmental aspects. While the determination of the impact of the three aspects has different information. The second step in the inferior process is determined by fuzzy rules. The third step determines the risk rating of each aspect. After finding the risk level, the concept of combining the three aspects with the formula below is determined.

This figure below plotting risk analysis to get a risk rating with the fuzzy logic technique above

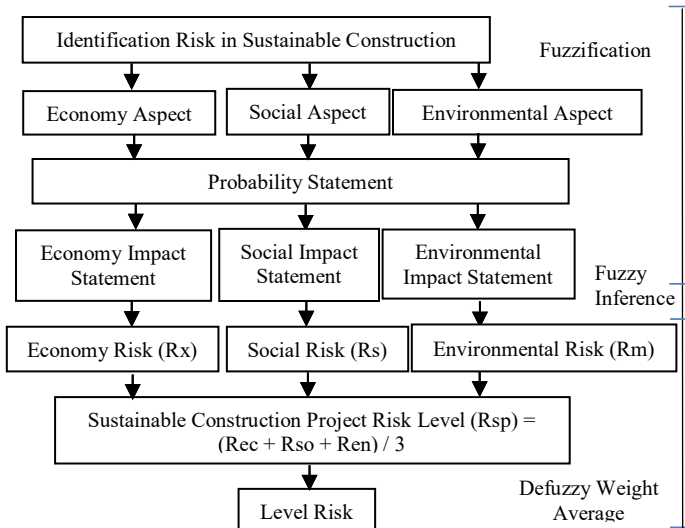

Fig. 5. Flowchart of Analyze Risk for Sustainable Construction Project

results of the research concept can be seen from the research scheme above. Job risks on sustainable construction projects have an influence on sustainable risk ratings (economy, social risk, and environmental risk). In each of these risks, there are calculations using fuzzy logic with different impacts on the three aspects, but the probability used is the same. So that the concept can be derived from the formula;

$$Rsp = (Rec + Rso + Ren)/3; Rec = f(p \times Iec)$$

$$Rso = f(p \times Iso); Ren = f(p \times Ien)$$

Note:

Rsp = Risk of sustainable construction project

Rec = Economic risk; Rso = Social Risk

Ren = Environmental risk

p = Probability (Economy, Social, Environmental)

Isp = Economy Impact; Iso = Social Impact

Ien = Environmental Impact

V. RESULT & ANALYSIS

A. Conclusion

The risk level for a sustainable construction project can be done by combining the level of economic risk, with a formula found $Rsp = (Rec+Rso+Ren)/3$. With note Rsp is Risk of sustainable construction Project, Rec is Economy risk, Rso is Social Risk, Ren is Environmental risk. We recognize that the problems underlying the proposed merger process are in particular social risks and environmental risks are complex. However, the risk information on a sustainable construction project that integrates these three risks must be accessible and understood by stakeholders. The merger process is carried out simply based on the previous literature on measuring financial, social and environmental performance.

B. Recommendation

- Risk analysis for sustainable construction projects needs to be tested for validity and reliability to find out the reality in the field.
- Because the concept of success is the incorporation of the three economic, social and environmental aspects, the theme needs to be reviewed on one of the major aspects, for example, natural disasters, economic crises, and others. Automatically because it is major, other aspects will have no effect when the formula is used.

REFERENCES

- Abduh, M., & Fauzi, T. (2012). "Kajian Sistem Assessment Proses Konstruksi pada GreenShip Rating Tool", *Konteks* 6, Universitas Trisakti, Jakarta 1-2 November 2012, hal MK111 - MK120
- Andriantiansaholoniaina, L. A., Kouikoglou, V. S., & Phillis, Y. A. (2004). "Evaluating strategies for sustainable development: fuzzy logic reasoning and sensitivity analysis", *Ecological Economics* 48 (2004) 149–17.
- Apine, A. (2016). "Risk Management in Sustainable Projects in the Construction Industry", Master thesis, UMEA University, Sweden
- Asmarantaka, N. S. (2014). "Analisis Resiko yang Berpengaruh Terhadap Kinerja Proyek Pada Pembangunan Hotel Batiqa Palembang", *Jurnal Teknik Sipil dan Lingkungan*, Vol.2.No.3, ISSN: 2355-374X, 2(3), 483–491.
- Bainley, H. (2015). *4.Environmental risk assesment* dalam Illustrated edition: Eastern Leases Project : Draft environmental impact statement for Groote Eylandt Mining Company (GEMCO). Hansen Bailey Environmental Consultants, Brisbane, Qld., Hal 4.1.-4.23
- Darda, A., Miki, M., Kova, I., & Ceci, Z. (2014). "Global Perception of Sustainable Construction Project Risks", *Procedia - Social and Behavioral Sciences*, 119 hal 456 – 465
- Haryanto, B. (2010). "Identifikasi dan Evaluasi Risiko Manajemen Rantai Pasok Komoditas Jagung dengan Pendekatan Logika Fuzzy". *Jurnal Manajemen dan Organisasi* Vol I. No. 2, Agustus 2010.
- Hubbard, G. (2009). "Measuring organizational performance: Beyond the triple bottom line". *Business Strategy and the Environment. Strategi Bisnis dan Lingkungan Bus. Strat.* Env. 18, 177–191, Online published 19 December 2006 di Wiley InterScience.
- Hwang, B., & Tan, J. S. (2012). "Sustainable Project Management for Green C onstruction : Challenges, Impact, and Solutions", *CIOB Construction Conference 2012*, 171–17
- Hwang, B., Shan, M., Phua, H., & Chi, S. (2017). "An Exploratory Analysis of Risks in Green Residential Building Construction Projects : The Case of Singapore", *Sustainability* 2017, 9, 1116.
- Ismael, D., & Shealy, T. (2018). "Sustainable Construction Risk Perceptions in the Kuwaiti Construction Industry", *Sustainability*, 10, 1854 , hal 1-17.
- Kleiner B.M, & Pearce, A.R (2013). " *The Safety and Health of Construction Workers on Green” Projects*". A Systematic Review of the Literature and Green Construction Rating System Analysis. The Myers-Lawson School of construction Virginia Tec.
- Koe, W.,Regina C.R.,& Alifien R.S (2014). "Kepentingan dan Implementasi Green Construction dari Sisi Pandang Kontraktor", *Jurnal Dimensi Pratama Teknik Sipil*, Surabaya, hal 1–7, Vol 3, No 2.
- Kusumadewi, S dan Purnomo, H, (2010), *Aplikasi Logika Fuzzy untuk Pendukung Keputusan*, 2nd edition, Graha Ilmu, Yogyakarta.
- Pavloff, C., Ap, L., Mullen, P., & Hoss, B. (2009). *Green Building : Assessing the Risks Feedback from the Construction Industry*, MA9-10142, Marsh, Chicago.
- PMI. (2013). *A Guide to the Project Management Body of Knowledge. Project Management Journal* (Vol. 44). <https://doi.org/10.1002/pmj.21345>
- Setiawan, A., Yanto, B., & Yasdomi, K. (2018.). "*Logika Fuzzy dengan Matlab (Contoh Kasus Penelitian Penyakit Bayi dengan Fuzzy Tsukamoto* ". ISBN: 978-602-51483-7-8, Jayapangus Press, Denpasar-Bali.
- Suharto, Wiryono, k.S (2008). "Analisis Risiko Operasional di PT Telkom dengan metode pendekatan ERM".*Jurnal Manajemen Teknologi*, Volume no 7 Number 1 2008.

Comparative Methods Analysis to Determine Open Channel Dimensions in Pit Mine

1st Tedy Agung Cahyadi
Mining Engineering, Faculty of
Mineralogy & Technology
UPN Veteran Yogyakarta
Yogyakarta, Indonesia
tedyagungc@upnyk.ac.id

2nd Sudaryanto
Mining Engineering, Faculty of
Mineralogy & Technology
UPN Veteran Yogyakarta
Yogyakarta, Indonesia
daryo_ta@yahoo.co.id

3rd Suyono
Mining Engineering, Faculty of
Mineralogy & Technology
UPN Veteran Yogyakarta
Yogyakarta, Indonesia
suyonohs@yahoo.com

4th Eddy Winarno
Mining Engineering, Faculty of
Mineralogy & Technology
UPN Veteran Yogyakarta
Yogyakarta, Indonesia
winarnoeddy@gmail.com

5th Angelina Metta Arilia
Mining Engineering, Faculty of
Mineralogy & Technology
UPN Veteran Yogyakarta
Yogyakarta, Indonesia
Ariliangelina@gmail.com

6th Charles Andrianto
Mining Department
PT. Antam
Pomalaa, Indonesia
Charles.andrianto2@antam.com

Abstract— *In designing the dimensions of open channel in open pit mining, rainfall intensity, downstream runoff coefficient, and catchment area are three amongst many factors that will determine the amount of runoff water entering the pit and will affect the dimensions of the open channels that are expected to handle the runoff water discharge. This research was conducted over two months at PT. ANTAM UBPN Sultra aimed to analyze the effect of the selection method for calculating time of concentration and rainfall plans for the dimensions of the drainage that were needed to handle the runoff water. This research made use of primary data from direct observation on the field and secondary data based on rainfall data from BMKG station. Izzard, William, and field observation method were employed to determine the time of concentration, while maximum, average, and minimum alternatives were used to determine the rainfall plans. Both factors greatly influenced the value of rainfall intensity. The results of this research were open channel (drainage) dimensions which were calculated based on the analysis of several methods for rainfall intensity. It is expected that the were appropriate and in accordance with the needs of the mine openings so that mining operations could run smoothly. (Abstract)*

Keywords— *Rainfall, Open Channel, Selection Method, Time of Concentration, Drainage (key words)*

I. INTRODUCTION

In the process of mining using open pit method, a pit is made by excavating the ground. Once the pit is formed, runoff and groundwater will naturally cause a flow down to the pit. Water in mining environment gives many advantages, for instance (a) to be used as a way to minimize dust, (b) to be a water source in a mineral processing plant, and (c) to operate drills (heavy machinery). In addition to being a helpful component, water in the mining environment can also cause flooding, leading to both material and health loss. (Silwamba. 2015).

Geographically, Indonesia is located near the equator line, causing it to have two seasons: rainy and dry season, which

may increase the number of rainfall intensity, as it is one of the hampering factors in the act of mining (Cahyadi et al. 2016). The source of water flowing into the pit comes from groundwater and rainwater. Water from rains that flows on the land surface is known as runoff water, whereas groundwater is rainwater that infiltrates land surface, found in a layer below the ground (Sahoo et al. 2014). An increase in rainfall intensity will affect the runoff volume, and If it is not handled correctly, runoff water will cause flooding on the work floor, submerging the ore that is to be mined, due to the excessive runoff water volume. The occurrence of these problems will affect work efficiencies of heavy equipment and will slow down mining activities (Warsito et al. 2018).

Mine drainage system is carried out to overcome surface water problem as supporting work in mining activities, but if any issue relating surface water in mining area happens, mine drainage system becomes a work priority (Cahyadi et al. 2018) ; (Widodo et al. 2018). The mine drainage system has many components, including an open channel or a ditch that serves as drainage to drain off excess water. Ditches are made to prevent flooding in mining areas, especially in working areas (Uli et al. 2017).

Some supporting case studies used in this research are the results of previous similar studies, (Rantello. 2017), and (Oryzoan. 2017). Rantello's study was conducted at PT. ANTAM UBPN Southeast Sulawesi and focused on determining what methods were needed to drain a flooded pit due to the absence of mine drainage system. The study later concluded that open channel is one of the most effective ways to drain the pit, along with in pit pumping (Rantello. 2017). Another study was done in PT. Jhonlin Baratama as the increasing water level interferes with mining activities despite having a well-designed drainage system as side support. After the research has been conducted in the field, the study concluded that the water level keeps increasing because the open channel and sump had eroded so the dimensions get smaller, causing rainwater flows freely on the working floor or areas (Oryzoan. 2017).

Studies have shown that in the act of mining, a drainage system is needed to support and optimize mining activities. The main factor in determining open channel dimensions is rainfall intensity. Flooding that happens in a pit which already has a drainage system indicates that analyzing how the rainfall intensity calculated is necessary.

This study aims to analyze the effect caused by a different method in calculating the time of concentration (using Izzard, William, and field observation) and different alternatives in calculating rainfall plan (using maximum, average, and minimum alternatives) towards the dimensions of the open channel. The purpose of designing an open channel is to result in dimensions that can help control runoff water without neglecting technical regulation.

II. LITERATURE REVIEW

The source of literature study done during this research comes from books, journals, and thesis reports. Dewatering concept in surface mines is very simple, since excavation with a depth deeper than an aquifer will cause water to flow into the pit, coming from fractures and surface runoff. The water flow will interfere with mining activities, from lowering work efficiencies to cause flooding and slope instability. Thus, dewatering is needed to keep mining activities run safely (Preene. 2015).

A. Rainfall Plan

First, The rainfall plan is calculated using Gumbel's distribution. This distribution is an extreme distribution that is considered more applicable if compared with other methods (Mujda and Pande. 1978). The equation of Gumbel's distribution is formulated as follows:

$$X_T = \bar{X} + K \cdot S \quad (1)$$

- X_T = Rainfall Plan
- \bar{X} = Rainfall alternatives
- K = Reduced Variate factor
- S = Standart Deviation (S_d)

B. Rainfall Intensity

Rainfall intensity is the height of rainfall water contained in an area unit (1 m x 1 m) during a period of time. The greater the intensity, the shorter the time period and the smaller the area of the rainfall becomes, and vice versa. High-intensity rainfall with a long time period rarely happens (Suroso. 2006). There are a lot of methods to depict rainfall intensity in which Mononobe method is one of them. Mononobe method is used when rainfall data are daily data. The Mononobe method is formulated as follows:

$$I = \frac{R_{24}}{24} \left(\frac{24}{t} \right)^{2/3} \quad (2)$$

- R_{24} = Rainfall intensity plans
- t = Time of concentration

C. Time of Concentration

In figuring rainfall intensity, time of concentration plays a great role in the calculation process which is as a divider in the Mononobe's method. This study uses three methods to determine the value of time concentration. Different results in the time of concentration are then used as a comparison in

designing open channel's dimension. All three methods have different parameters, so it can be seen which methods are the most optimal.

These methods are Izzard's (1946), William's (1922), and value obtained on observation. Izzard's method uses a coefficient based on surface smoothness as one of its parameters. The equation for Izzard's method is as follows:

$$t_c = 41,025(0,0007i + c) L^{0,33} S^{-0,333} i^{-0,667} \quad (3)$$

- i = Rainfall Intensity, in./h
- c = Rettardance coefficient
- L = Length of the flow path, ft
- S = Slope of flow path, ft/ft

On the other hand, formula (3) has the value of (c) stands between 0,07 for very smooth pavement to 0,012 for concrete pavement and 0,06 for dense turf (Li and Chibber, 2008). Meanwhile, William's method (1922) is used only if the catchment area is smaller than 129,5 km² (Li and Chibber, 2008). William's equation is presented as follows:

$$t_c = 60 LA^{0,4} D^{-1} S^{0,2} \quad (4)$$

- L = Basin Length, mi
- A = Basin Area, mi²
- D = Diameter (mi) of a circular basin of area
- S = Basin Slope, %

The catchment area's diameter is one of the parameters in William's method. This parameter is a difference between William's and Izzard's method, where in Izzard's method the length used as a parameter is only the length of upstream to downstream.

The last method used in this study is value obtained from observation. This method only uses a total of rain duration and days of rains happening during a period of time (13 months). Because of the compatibility rate of this method is higher than the other two methods, this method is considered as the most representative one. The equation for this method is formulated as follows:

$$t_c = \frac{\text{Total of rain duration}}{\text{Rain days}} \quad (5)$$

D. Runoff (Discharge Water)

Rainwater from the precipitation process will flow on the surface if it does not infiltrate below the soil. This flow is called runoff water, as it flows from upstream to downstream, flowing anywhere to the lowest surface. In the mining area, the lowest level of the catchment area is the bottom of the pit. It is a natural law that water will flow from higher to a lower area in the form of river, small stream, or underground flow. In designing the dimension of the open channel, a maximum discharge is needed to be estimated so that the dimension could handle the desired discharge accordingly. To estimate the value of runoff (discharge) water, rational method (Kuchling. 1889) can be used as an estimating method, as seen as follows:

$$Q = 0,278 \cdot C \cdot I \cdot A \quad (6)$$

- Q = Maximum discharge (m³/s)
- C = Runoff Coefficient for the rational method
- I = Rainfall Intensity (mm/h)
- A = Catchment area (km²)

E. Dimension of Open Channel

The open channel should be made inside or outside the pit as a perimeter to control discharge water flowing into the pit. In most mining sites across Indonesia, the open channel is proven to be the most effective way to control the discharge water as a drainage method, to keep the work condition to its most effective (Preene. 2015). The most common shapes of open channels are square, triangle “v”, and trapezoid (Rosadi. 2011). Among those three shapes, a trapezoidal shape is often chosen to be the shape of an open channel used in Indonesian mining sites. The trapezoidal shape is easy to maintain and has the lowest construction budget, making it the top choice in sites. Open channel with trapezoidal shape will work at its optimum condition using a 60° angle inclination.

When determining the grade of the bottom hydraulic line, sedimentation process of carried particles in water flow should be considered as a factor, so the sediments will not interrupt the water flow. To prevent sedimentation, the grade should be between 0,25-0,5% (Pfleider. 1968). This study uses 0,25% for the grade, while the value of (n) uses Manning’s roughness coefficient. Manning’s formula for estimating open channel dimension is formulated as follows:

$$Q = 1/n \cdot A \cdot S^{1/2} \cdot R^{2/3} \quad (7)$$

- Q = Peak Discharge (m³/s)
- A = Area (m²)
- S = Grade of the hydraulic line (%)
- R = Hydraulic radius (meter)
- n = Manning’s roughness coefficient

III. METHODOLOGY

This study is based on primary and secondary data including catchment area topographic map, ten-year- rainfall data (2008-2017), time-based rainfall data in 13 months, and topographic map of the final pit. A step-by-step methodology used in this study is seen in Fig. 1.

IV. RESULT AND ANALYSIS

A. Catchment area

Downstream water flows from the hill on the south of the pit is determined by the analysis based on the catchment area. Water flow analysis using catchment area distribution is depicted in Fig. 2.

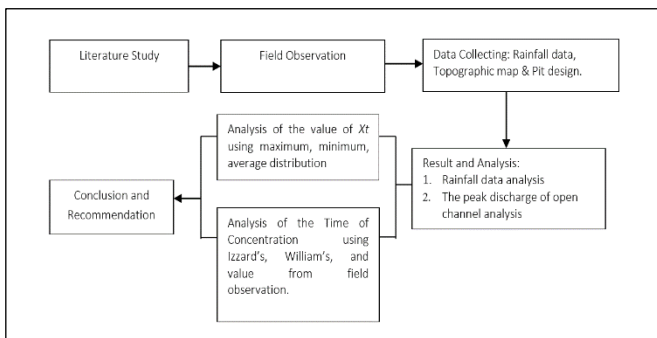

Fig. 19. Research Steps.

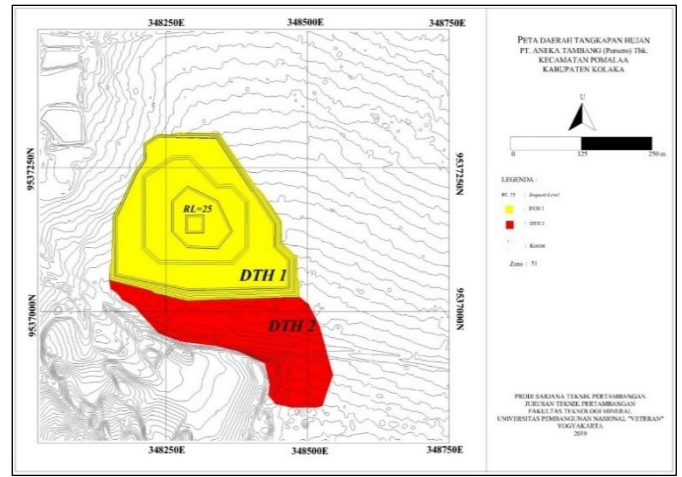

Fig. 1. Runoff Water Flow

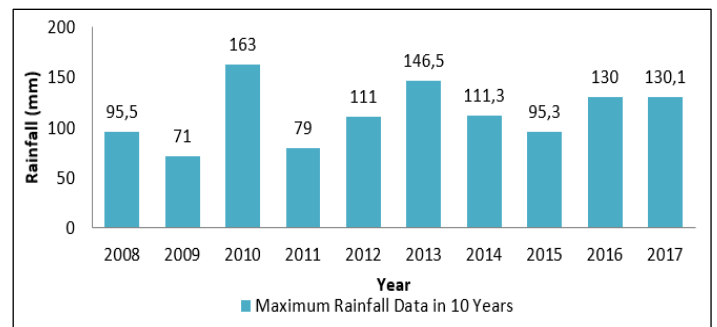

Fig. 2. 10 Year Period Rainfall Data.

B. Rainfall Data

Rainfall plans were calculated based on rainfall data collected from Pomalaa’s BMKG station. Fig. 3 shows rainfall values on research area for 10 years.

C. Rainfall Plans Using Maximum Value Alternative

Calculation of rainfall plans using the maximum value alternative was done by substituting X on $Xt = X + k \cdot Sd$ on gumbell’s distribution method with the maximum value of rainfall in ten years period (163 mm). The result of this alternative is seen in Table I.

D. Rainfall Plans Using Average Value Alternative

Calculation of rainfall plans using the average value alternative was done by substituting X on $Xt = X + k \cdot Sd$ on gumbell’s distribution method with the average value of rainfall in ten years period (113,3 mm). The result of this alternative is seen in Table I.

TABLE I. TABLE COMPARISON OF RAINFALL PLANS USING SEVERAL ALTERNATIVES

Rainfall Plans Using Maximum Value Alternative							
S_n^a	S_x	RP^b	Y_t^c	K^d	X_t^e	TL^f	$\%^g$
1	29,34	2	0.37	1.24	199.38	2	75
		3	0.90	-1.45	120.56		55.56
		4	1.25	1.78	215.16		43.75
		5	1.50	1.26	200		36
		6	1.70	0.10	165.81		30.56
Rainfall Plans Using Average Value Alternative							
S_n	S_x	RP	Y_t	K	X_t	TL	$\%$
1	29,34	2	0.37	1.24	149.65	2	75
		3	0.90	-1.45	70.83		55.56
		4	1.25	1.78	165.43		43.75
		5	1.50	1.26	150.27		36
		6	1.70	0.10	116.08		30.56
Rainfall Plans Using Minimum Value Alternative							
S_n	S_x	RP	Y_t	K	X_t	TL	$\%$
1	29,34	2	0.37	1.24	107.38	2	75
		3	0.90	-1.45	28.56	2	55.56
		4	1.25	1.78	123.16	2	43.75
		5	1.50	1.26	108	2	36
		6	1.70	0.10	73.81	2	30.56

^a Reduced Standard Deviation(S_n)

^b Rainfall Return Period (RP)

^c Reduced Variate (Y_t)

^d Factor Reduced Variate (K)

^e Rainfall Plans (X_t)

^f Mine Period (TL)

^g Hydrology Risk (%)

TABLE II. TABLE RESULT OF THE TIME OF CONCENTRATION SIMULATION USING THREE METHODS

Alternative	Field Observation Based		Izzard's Method		William's Method	
	T (Hour)	Intensity	T (Hour)	Intensity	T (Hour)	Intensity
Maximum	2.9	34	1.26	59.3	1.82	46.4
Average	2.9	18.3	1.26	31.9	1.82	25
Minimum	2.9	25.5	1.26	44.5	1.82	34.8

TABLE III. DESIGN COMPARISON USING SEVERAL ALTERNATIVES

Dimensions of Open Channels Based on Field Observation Derived Rainfall Intensity							
Open Channels	d (m)	b (m)	B (m)	a (m)	d (m)	b (m)	
	Depth	Base width	Top Width	Diagonal Line	Depth	Base width	
Maximum	I	0.35	0.40	0.80	0.40	0.35	0.40
	II	0.54	0.62	0.62	0.63	0.54	0.62
Average	I	0.31	0.36	0.72	0.36	0.31	0.36
	II	0.49	0.56	0.56	0.56	0.49	0.56
Minimum	I	0.27	0.32	0.64	0.32	0.27	0.32
	II	0.43	0.49	0.49	0.50	0.43	0.49

Dimensions of Open Channels Based on Field Observation Derived Rainfall Intensity							
Open Channels	d (m)	b (m)	B (m)	a (m)	d (m)	b (m)	
	Depth	Base width	Top Width	Diagonal Line	Depth	Base width	
Maximum	I	0.43	0.49	0.99	0.49	0.43	0.49
	II	0.67	0.77	0.77	0.77	0.67	0.77
Average	I	0.38	0.44	0.89	0.44	0.38	0.44
	II	0.60	0.69	0.69	0.69	0.60	0.69
Minimum	I	0.34	0.39	0.78	0.39	0.34	0.39
	II	0.53	0.61	0.61	0.61	0.53	0.61
Dimensions of Open Channels Based on William's Method Derived Rainfall Intensity							
Open Channels	d (m)	b (m)	B (m)	a (m)	d (m)	b (m)	
	Depth	Base width	Top Width	Diagonal Line	Depth	Base width	
Maximum	I	0.39	0.45	0.90	0.45	0.39	0.45
	II	0.61	0.70	0.70	0.70	0.61	0.70
Average	I	0.35	0.40	0.81	0.40	0.35	0.40
	II	0.55	0.63	0.63	0.63	0.55	0.63
Minimum	I	0.31	0.36	0.71	0.36	0.31	0.36
	II	0.48	0.55	0.55	0.56	0.48	0.55

E. Rainfall Plans Using Minimum Value Alternative

The calculation of rainfall plans using the minimum value alternative was done by substituting X on $X_t = X + k \cdot S_d$ on gumbell's distribution method with the minimum value of rainfall in ten years period (71 mm). The result of this alternative is seen in Table I.

F. Time of Concentration

The calculation of Time of concentration used in figuring rainfall intensity was calculated using 3 methods: Izzard's, William's, and value from direct field observation. All three methods resulted in a very different value for each method. The Results of all methods are seen in Table II.

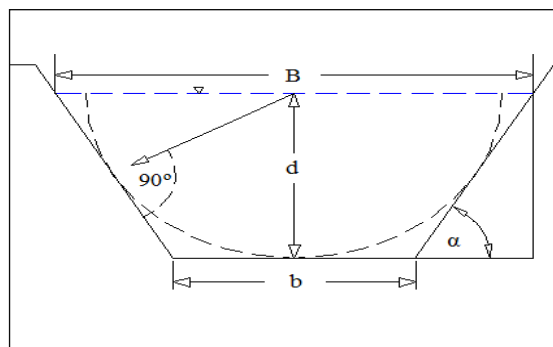

Fig. 3. Concept Dimension of Open Channel

G. Design Comparison

Based on the value of rainfall intensity seen above, figuring the dimension of the open channel according to peak discharge value was done by simulating all alternatives to conclude which alternative is the best option. The results of simulation

using each intensity values are depicted on Table III, while the conceptual dimension of the open channel is presented in Fig. 4.

H. Analysis

The results above indicated that using the maximum value alternative produced the biggest Xt value (199,38 mm), if it was compared with the other two alternatives; the minimum value alternative ($Xt = 107, 38$ mm) and average value alternative ($Xt = 149,65$ mm). For the time of concentration, the longest time was obtained from the value based on field observation with 2,9 hour, while the Izzard (1,26 hour) and William (1,82 hour).

After the value of Xt has been estimated using 3 alternatives, that Xt is then gone through another trial to calculate rainfall intensity with 3 different time of concentration from three different methods with 2,9 hour for field observation's value, 1,26 for Izzard's method, and 1,82 hours for William's method. Table 4 shows that Izzard's time of concentration produced the biggest rainfall intensity in all alternatives (maximum, average, and minimum) followed by William's method, and the lowest value was from field observation value.

Scrutinizing the result of the simulation that has been done, it can be concluded that the bigger the value of time concentration will lead to lower rainfall intensity. This is the opposite of the proposition that a high rainfall intensity affects the dimensions of the open channel. A rise in rainfall intensity value will generate in the higher number of the dimensions. This conclusion is poured simply in the result of rainfall intensity using Izzard's method for its time of concentration, with a time of concentration of 1,26 hour resulting in rainfall intensity of 59,3 mm (using a maximum alternative) and produces a total dimension of 0,33 m² and 0,77 m² for open channel 1 and 2.

In deciding which alternatives to be used in calculating rainfall plans, there are factors to consider. One of them is the compatibility rate between rainfall value and field situation. During this study, for a two months long observation, the rain frequencies on the research area were quite high, with low to middle intensity. With this information to ponder, it was then decided to use the maximum value alternative in the calculating process. The decision to use the maximum alternative was based on the purpose of this research itself which was to design dimensions that are compatible and optimum, even in a bad weather condition and high-intensity rains.

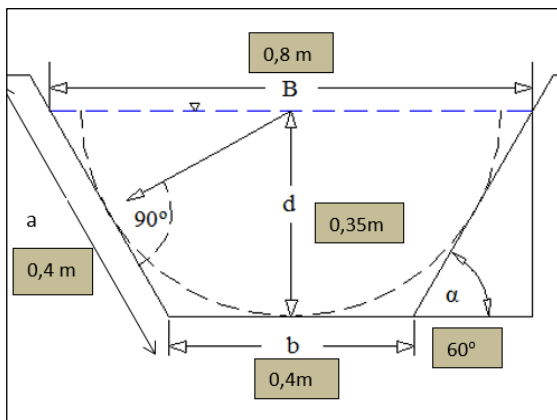

Fig. 4. Dimensions of the open channel for catchment area I

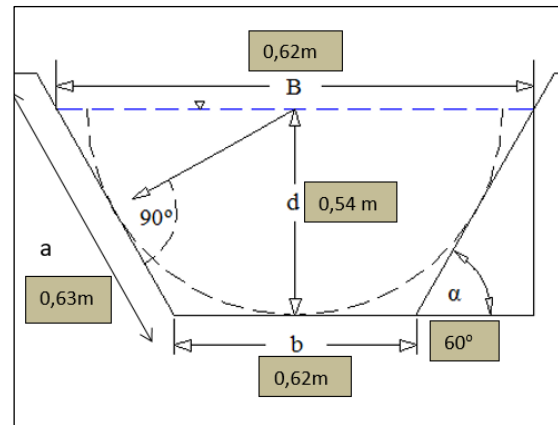

Fig. 5. Dimensions of the open channel for catchment area II

To estimate rainfall intensity, concentration of time is needed as one of its factors. From the three methods, there is a value based on field observation which is the closest and becomes the most appropriate in accordance with field situation as it is collected by recording how long each rain lasts on the research area.

After the maximum alternative and value of field observation was decided as the concentration time, the dimensions of the two open channels for each catchment area could be seen in Fig. 5 and Fig. 6. These channels were designed for the purpose of supporting mining operations to run smoothly.

V. CONCLUSIONS AND RECOMMENDATIONS

A. Conclusions

- 1) The best selected method was maximum valued rainfall plans and field observation-derived time concentration to give the maximum value to calculate rainfall intensity for the open channel dimensions that should meet the pit's needs.
- 2) Rainfall intensity was calculated based on the rainfall plans using maximum value alternative (199,38 milimeter/day) and field observation-derived time concentration (2,9 hour and therefore the rainfall intensity was 34 milimeter/hour.
- 3) Rainfall intensity was used to find peak discharge (Q) to determine the dimensions of the open channel. Based on the peak discharge, there was one open channel for each catchment area. The geometry of each open channel could be seen in Fig. 5 and Fig. 6.

B. Recommendation

- 1) It is better to calculate rainfall intensity based on the maximum value of rainfall plans and time of concentration to minimize or prevent flood in a pit mine.
- 2) When comparing several methods to determine rainfall intensity, it is best to consider pit conditions so that the results are in agreement with both theoretical and practical paradigm.

ACKNOWLEDGMENT

The authors would like to thank Lembaga Penelitian dan Pengabdian Masyarakat (LPPM) UPN Veteran Yogyakarta for supporting this research.

REFERENCES

- Pfleider. E., "New York, American Institute of Mining, Metallurgical, and Petroleum Engineers", 1968.
- Cahyadi, T.A., Widodo, L.E., Syihab, Z., Notosiswoyo, S., "Conceptual Model of Groundwater Depressurization in Different Permeability Caused by Drain Hole Installation", 329-341, 2016.
- Li, Ming- Han., Chibber, Paramjit, "Overland Flow Time of Concentration on Very Flat Terrain". Transportation Research Record: Journal of the Transportation Research Board, No. 2060, Transportation Research Board of the National Academies, Washington, D.C., 2008, pp. 133-140, 2008.
- Silwamba C., Chileshe. P R K, "Open Pit Water Control Safety: A Case Of Nchanga Open Pit Mine, Zambia". International Journal Of Scientific & Technology Research Volume 4, Issue 08, August 2015. ISSN 2277-8616, 2015.
- Widodo L.E, Cahyadi T.A, Syihab Z, Notosiswoyo S, Iskandar I, Rustamaji H.C, "Development of drain hole design optimisation: a conceptual model for open pit mine slope drainage system with fractured media using a multi-stage genetic algorithm". Environmental earth sciences, v. 77 pp 721, 2018.
- Rosadi, P. Mekanika Fluida. Yogyakarta. Chapter IV, 2011.
- Cahyadi, T.A., Widodo, L.E., Fajar, R.A., Baiqun, A. Influence of drain hole inclination on drainage effectiveness of coal open pit mine slope. *IOP Conf. Series: Earth and Environmental Science* 212 (2018) 012060, 2018.
- Mudja, Pande., Al- Mashidani, G. A simple version of Gumbel's method for flood estimation. *Hydrological Sciences-Bulletin-Indes Sciences Hydrologiques*, 23, 3, 9/1978 , 1978.
- Preene, M. Techniques and Developments in Quarry and Surface Mine Dewatering. Proceedings of the 18th Extractive Industry Geology Conference 2014 and technical meeting 2015, EIG Conferences Ltd, 250pp, 2015.
- Uli, Marina., Saismana, Uyu. Kajian Teknis Sistem Penyaliran Dan Penirisan Tambang Pit 4 PT. Darma Henwa Site Asam-asam, 2017.
- Warsito, Ulfa., Cahyadi, T.A., Setyowati, I. Pentingnya Metode Penyaliran Pada Kegiatan Tambang Terbuka Di Indonesia. *Prosiding Seminar Nasional ReTII*, 2018.
- Oryzoan, Evas. Kajian Teknis Sistem Penyaliran Pada PT. Jhonlin Baratama Site Sungai Dua, Kalimantan Selatan. 2017, unpublished.
- Ranteallo, Andika. Rancangan Sistem Penyaliran Bukit Fortuner Tambang Selatan PT. Antam (Persero) Tbk UBPN Sulawesi Tenggara. 2017, unpublished.
- Stasiun Badan Meteorologi, Klimatologi, dan Geofisika Pomalaa.. Curah Hujan Periode 2008-2017 (as requested). 2018.

Community Participation Criteria to Achieve Sustainable Road Projects

1st Wahyu Adistya Rindarti
Department of Civil Engineering
Institut Teknologi Sepuluh Nopember
Indonesia (ITS)
adistyarindarti@gmail.com

2nd Mohammad Arif Rohman
Department of Civil Engineering
Institut Teknologi Sepuluh Nopember
Indonesia (ITS)
arjf@ce.its.ac.id

3rd Cahyono Bintang Nurcahyo
Department of Civil Engineering
Institut Teknologi Sepuluh Nopember
Indonesia (ITS)
bintang@ce.its.ac.id

Abstract— *The operational phase of the road project is considered successful when this type of facilities can improve the community's life. One of the criteria for the project that is defined to be successful is by applying the concept of sustainable development, consisting of three aspects namely economic, environmental, and social aspect. This paper discusses social aspect regarding the role of the community participation in road construction projects. But in the existing practice, the application of the process of community participation only exists in environmental impact assessments and is considered as a form of formality in obtaining a development permit. Previous researches on community participation have been carried out in several regions, such as public buildings and urban planning. However, still limited researches have been conducted in the area of road construction process. This paper investigates community participation criteria using mean analysis. According to the analysis, it was found 20 criteria of an appropriate community participation in this type of project to achieve a more sustainable highway project in Surabaya.*

Keywords— *road, community participation, sustainable development, highway*

I. INTRODUCTION

The rapid development of technology responsive to transportation infrastructure. Based on Indonesian Republic Regulation No. 38 of 2004, roads are transport infrastructure that covers all parts of the road, including buildings and complementary equipment intended for traffic. The existence of roads is very useful to facilitate the community in carrying out daily activities. To support this, good management is needed to carry out a successful road project. The operational phase of the road project is expected to improve the community's life in supporting their daily activities. One of the success criteria for the project is by applying concept of sustainable development as a solution to improve community living standards by adapting natural resources and human needs.

Elkington (1998) proposed that the concept of development is based on integration of three fields, that is environmental, financial, and social aspect, called the triple bottom line (TBL). Sustainable development referred by UNESCO definition refers to improving people's living standards and implementing efficient development. In addition, the utilization of our natural resources found in the human environment must also be guaranteed for long-term needs and considering the existence of future generations. Community participation is one of the main points of sustainable road development in the social field (Lawalata, 2013). Community participation is an activity that aims to

realize the equality of rights for the people inhabit around the road development. Community participation encourages the community to becomes more critical in assess and criticize policies that will and are being carried out by the government. In the existing practices, in the context of infrastructure project development activities the process of community participation is usually carried out as part of the Environmental Impact Analysis (Li et al., 2013) where is part of the formal procedure to get the government approval in the development process (Handayani, 2008). Several studies on the concept of participation have also been carried out in several fields, for example for toll road projects, public buildings, urban planning, and other projects. But, currently the criteria for measuring the performance of the public construction process are still not clear enough.

As the second largest city in Indonesia, Surabaya has a rapid road development project. The highly dynamic mobilization of the population of Surabaya requires provision of adequate roads both in terms of quality and quantity. In connection with that, the road construction process can be in line with the concept of sustainability. One effort to realize sustainable development in infrastructure projects, including in road development is through the implementation of community participation principles.

This paper discusses social aspects regarding the role of community participation in road construction projects. In practice, formality to obtain building permits is applied to environmental impact assessments (EIA). Previous researches on community participation have been carried out in fields such as public buildings and urban planning. However, researches in community participation at road development are still limited. Therefore, this study seeks to bridge the definitions in the literature by finding criteria for community participation that are in accordance with the context of sustainable road infrastructure in the city of Surabaya. The concept of participation that is appropriate for the development of road projects can be formulated with the criteria for measuring performance.

II. LITERATURE REVIEW

The existence of roads is the main thing in supporting human movement activities, especially on land side. In another sense, road construction coincides with the development of human activities, both the development of the area and the mobility of people and goods. The better quality and availability of road infrastructure promotes the better ease of activities for human being.

A. Road Project

Road is a land transportation that is useful to facilitate the community in carrying out daily activities. In Indonesia, the existence of roads is regulated in Government Law Number 38 of 2004 concerning Roads. Road classification is an important aspect that must be identified at first before delivering the road design, because the road classification plan determines design standard criteria.

B. Sustainable Development

It is necessary to apply the concept of sustainable development to achieve a successful road project. The solution to improving human living standards by adjusting the limitations of natural resources with basic human needs is the concept of sustainable development. Elkington (1998) argued that the concept of sustainable development is based on the integration of three dimensions namely environmental, economic and social, called the triple bottom line (TBL). Wheeler (2004) argued there are three pillars that support sustainable concepts which interact with each other.

According to Budimanta (2005), how to view activities carried out systematically and planned in order to improve the welfare, quality of life, and human environment without reducing access and opportunities for future generations to optimize it is the meaning of sustainable development. Moreover, sustainable development not only concentrates on environmental issues (Marlina, 2009). More broadly than that, sustainable development encompasses three policy spheres: financial development, social development, and environmental protection.

In general, the concept of sustainable development is dominantly seen in terms of the environment and the economy, while on the social side it is slightly overlooked. Sustainable roads must meet the functional requirements of community development and economic growth, by reducing negative impacts on the environment and utilizing natural resources, during the project life cycle from conceptual phase to operational phase have to consider the sustainability of the road.

C. Concept of Sustainable Road

According to Greenroads (2011) road assessment institutions, sustainable road is a road management activity that applies environmental principles starting from the stages of financing, process of planning or design, construction, road maintenance, and handling the effects of climate change. Whereas environmental principles are principles that focus and prioritize to environmental preservation elements such as the efficient use of water resource and energy resources, reduction of waste and pollution, and a synergy of natural and artificial environments. Community participation is an activity that aims to realize equality of rights for the people domiciled in the area around the road.

D. Concept of Stakeholder

In infrastructure projects, the role of stakeholders is very important and influential in achieving a sustainable highway project. The success of the project is influenced by many conditions including the management of stakeholders or stakeholders associated with the project. According to Freeman (1984), stakeholders are a community group or individual who influence and influence each other in

achieving certain goals of the organization. Wibisono (2007) posited that the notion of stakeholders is a person or group that has a direct / indirect interest, and can influence or be influenced by the activities and existence of the company.

To achieve sustainability in road projects, it is very important to identify the parties involved, what needs to be done, and what resources are involved or needed. Koppenjan et al (2004) argued the way to find out the interests of stakeholders can be approached by forming networks that can involve stakeholders by learning perceptions, goals, and resources to get mutual benefits. According to Ghazali & Chariri (2007), the concept of stakeholders is that a company is not an entity that only operates for its own sake, but is useful for stakeholders. Thus, the existence of a project is strongly influenced by the support provided by stakeholders to the project, so that the needs of each party can be fulfilled.

E. Project Stakeholder

In order for the desires and needs of each party in a project to be realized in a joint project to achieve goals and objectives, it is necessary to identify the organization or individual, both internally and externally, which will influence the project and must be anticipated during the project. Individuals, groups, and communities can be said as stakeholders if they have characteristics that is power, legitimacy, interests in the program, as expressed by Budimanta et al (2008).

Soemanto (2007) categorized it into four groups, including government, private sector, non-governmental organizations (NGOs), and communities. Sukada (2007) revealed that the degree of stakeholder relevance to company activities was weighed with three things, namely power, legitimacy, and urgency. Stakeholder involvement is determined based on the degree of relevance or conformity with the existence and program to be held.

According to Li et al. (2013), failure to respond and fulfill community expectations can lead to opposition from stakeholders and can lead to project failure. Thus, infrastructure must provide community satisfaction to achieve success. Chan et al. (2002) defined satisfaction as the level of happiness of people affected by a project. Because infrastructure projects affect the community not only in the short or medium term, the success of infrastructure projects must ensure that they can have a positive impact on the community over a long period of time during the project life cycle.

F. Concept of Community Participation

One effort to realize sustainable development in infrastructure projects is by implementing the principle of community participation. In general, Arnstein (1969) proposed a model called "Citizen Participation Ladder". In this concept, a participation define based on the power of society to determine the end product. Each rung on a ladder of Citizen Participation Ladder is described based on "corresponding to the extent of citizen's power in determining the plan and/or program". Cohen (1977) defined participation into four types based on participation systems and participation mechanisms.

Hobley (1996) argued participation classified into seven types of participation. From several meanings of community participation by some experts mentioned above, it can be concluded that community participation is an activity that involves the community not only in the implementation phase,

but also involving the community in planning and development phase. Furthermore, simply community participation is voluntarily involvement of a person (individual) or a group of people in a set of activities starting from the planning process, executing process, and developing process of a program. Participation intend to give opportunities to the community in expressing their opinions to assess ongoing programs.

G. Concept of Community Participation at Sustainable Development

The relationship between sustainable development and community participation have discussed in several previous studies. Silvius (2016) argued the process of participation shows a positive influence on the success of the project. Bal (2013) argued involvement of participation in construction projects promote the integration of design concepts to achieve sustainable targets.

Lim (2008) proposed the process of participation among key decision makers and the community tends to improve the consistency of project results that support the sustainable concept. Aaltonen (2010) believed to reduce the risk of stakeholders who are at odds with the project, by involving stakeholders in project development and implementation as well. Basically, several studies on stakeholder participation and involvement show the positive impact on the project success to achieve a sustainable project.

H. Concept of Community Participation in Construction Projects

According to Creighton (2005), community participation is purpose to get involvement from a lot of people, although it is possible to reach each individual. Then, Meshack (2004) emphasized that participation is a process of communication, in terms of sharing information, power, attitudes, and interests. According to Sanoff (2007), actual participation not only aims to reach agreement, but also involving people to change and adjust their daily environment purposively and meaningfully.

In this study, the concept of community participation is defined as the process of involving people whom positively and negatively affected by road development projects and becoming road users in the decision-making process. According to Shan (2011), community participation can be a challenge to implement, because some organizations have a unique attitude about the value of participation, and are concerned that citizen’s active involvement can cause chaos and social conflict. However, Chan (2007) in general, the community is not entitled to participate in formulating a development plan, but can express their opinions and concerns about a particular project milestone, as well as find out information about the conditions on several projects.

I. Concept of Community Participation in Indonesia

In Indonesia, the legal basis for implementing community participation is the 1945 Constitution, which states that participation is a basic right of citizens, and political participation as a basic principle of democracy. The process of community participation is more possible in the era of reform. As a result, the community becomes more critical and open to assessing and criticizing the procedures that will be implemented by the government.

Ideally, the process of good community participation is when it can be done by fulfilling the rules of participation. The

city of Surabaya as the second largest city in Indonesia has a rapid level of road development. The existing conditions with the highly dynamic mobilization of the population of Surabaya require the provision of adequate roads and improvements. The research variables obtained by the literature study in the previous chapter, were the criteria of community participation that were suitable for the construction project. Table I describes the criteria for community participation obtained from previous research in accordance with the sustainable concept.

TABLE I. RESEARCH VARIABLES

No.	Criteria for Community Participation	Source
1	Participation process involving all the community affected.	(Blackstock,2012), (CANARI,2004), (Bickerstaff,2002), (Luyet,2012)
2	The participation process involves affected communities from the initial stages of the project.	(Blackstock,2012), (CANARI,2004), (Luyet,2012), (Reed,2008)
3	The implementation process gets high participation from affected communities.	(CPPE,2000)
4	The participation process provides information that fits the needs of affected communities.	(Blackstock,2012), (CANARI,2004), (Luyet,2012), (Carr,2012)
5	The participation process is carried out transparently, so that affected communities can easily search for general information relating to the project.	(Blackstock,2012), (Bickerstaff,2002), (Luyet,2012)
6	There is specific rule in implementing the participation process.	(Luyet,2012), (Carr,2012)
7	The participation process is carried out in two way communication (interactive).	(Blackstock,2012), (CANARI,2004), (Luyet,2012), (Carr,2012)
8	The participation process is carried out at all times throughout the project life cycle (not only at several project stages).	(CANARI,2004), (Bickerstaff,2002)
9	The participation process involves all groups (without being restricted by gender or social status)	(Blackstock,2012), (CANARI,2004), (Luyet,2012), (Carr,2012)
10	There are appropriate facilitators or moderators in the participation process.	(Blackstock,2012), (Luyet,2012), (Carr,2012), (Reed,2008)
11	The participation process can increase knowledge or build the capacity of affected communities to understand the problems being discussed.	(Blackstock,2012), (Luyet,2012), (Flannery,2011)
12	The participation process can build understanding between all stakeholders involved.	(Blackstock,2012), (IAIA,2006)
13	There is sufficient time to carry out the participation process (enough time for affected communities to receive, understand, and respond to the information provided).	(Luyet,2012)
14	All parties involved respect the process carried out.	(CANARI,2004), (Luyet,2012), (Woltjer,2002)
15	The results of the participation process decisions are delivered equally to all affected communities.	(Blackstock,2012)
16	The results of the participation process decisions can be accepted by the affected communities.	(Blackstock,2012), (Carr,2012)
17	There is cost effectiveness in implementing the community participation process.	(Blackstock,2012), (Carr,2012)
18	The results of decisions can be agreed upon by the broadly affected communities, so the decisions have strong legitimacy.	(Blackstock,2012), (Carr,2012)
19	The results of the participation process are comprehensive plans (considering many aspects and interests as a whole).	(Blackstock,2012)

No.	Criteria for Community Participation	Source
20	The results of the participation process are adaptive to the context (can be adapted to the conditions around it)	(IAIA,2006), (Ng,2012)
21	The results of participation decisions can be applied in the field.	(Blackstock,2012)

The focus of this research is on determining the criteria for community participation in sustainable road projects in the city of Surabaya. This study is intended to bridge the gap exists in the literature by finding criteria for community participation that are appropriate for the context of road development to achieve sustainable infrastructure in Surabaya. The concept of participation that is appropriate for the construction of road projects can be formulated by identifying criteria for measuring road performance. Based on these criteria, an assessment or evaluation of the implementation of the existing concepts can be carried out.

III. METHODOLOGY

Research methodology is a set of analysis used to answer the problems described in the introductory chapter. Sedarmayanti (2002) defined research methodology as a discussion of theoretical concepts, advantages and disadvantages in research. Methodology testing is study of the steps in using a method. Quantitative methods were chosen because so far there has not been much research in the field of community participation using this approach.

Based on data from the Public Works Agency of the roads and the Government of Surabaya, the length of roads in the city of Surabaya up to 2010 was 1,421.51 km and the total length of roads was 3,334 m. The object of this research is 3 types of road networks that were built during the reform period, which began in 1998, because during the reformation period the opportunity for the community to participate was open. The purpose of this study is to provide a description of the criteria for community projects in the city of Surabaya.

A. Questionnaire Preparation Method

The measurement scale used in this study is a Likert Scale, that is a scale that converts questions into statements and asks respondents to express their level of agreement with the statement by marking boxes or circling their answers. The use of the Likert Scale is considered appropriate for measuring social opinion, attitudes and symptoms. Research variables are social symptoms that have been specifically determined by researchers.

Sekaran (2003) claimed advantage of this method is that many statements can be included without consuming many places, quite simple to answer by the respondent, and simple enough to be marked and analyzed by the researcher. Before the main survey was conducted, this study conducted a pilot test first. Ng et al (2010) argued that the existence of a pilot test aims to understand the current situation and verify the suitability of variables. These pilot test aims to ensure that the questionnaire and cases to be given do not cause bias or misunderstanding.

B. Data Collection

This study aims to define the relationship or correlation between risk factors and their impact. Risk factors and their effects are observed at the same time, meaning that each

subject of the study is only observed once. According to Notoatmodjo (2002), a research conducted to study the dynamics of correlation between risk factors and their effects, with approaches, observation or data collection at one time (point time approach) commonly called as a cross-sectional survey.

It means that each research subject was only observed once and the measurements were made on the status of the character or subject variable at the time of examination. This does not mean that all research subjects were observed at the same time. This study uses a cross-sectional data collection method because it focuses on the analysis of a large group of respondents' perceptions and is not related to the investigation of changes in object processes.

Questionnaires are the instruments most often used to obtain qualitative data. The questionnaire aims to find more complete information about a problem. Respondents do not need to feeling worried if they give an answer that is not in accordance with the reality. Respondents were asked to give an assessment of each variable. The questionnaire was distributed to the community in the area of the road project in Surabaya. One week after distribution, each respondent will be contacted to remind them that the questionnaire will be taken back in two weeks.

The questionnaire was taken two weeks after being given to the respondent. It is expected that the return rate of the questionnaire can reach 70-80% to convince the representative of the sample (Hadi,2004). The questionnaire is both closed and open. In closed questionnaire, respondents answer the questionnaire questions by choose several answer choices with different weight. In open questionnaire, respondents write their answer at the blank sheet in accordance with their wishes and circumstances.

IV. RESULT & ANALYSIS

The first stage is a preliminary survey to measure the level of relevance of the criteria completed in the previous chapter using a Likert Scale. Preliminary survey is useful to reduce the variables obtained from the literature review by means of expert judgment. The second stage is main survey which contains methods of data collection using questionnaires. The source of the questionnaire data was taken from the processed data from the preliminary survey that had been developed.

A. Criteria for Community Participation

Preliminary survey aims to measure the level of relevance of the variables described in the previous chapter. This study focuses on construct validity to see the validation of the criteria to be used. The researcher conducted a preliminary survey by submitting a questionnaire testing to the experts and practitioners in the form of assessment and opinion. Judgment was carried out on seven lecturers and practitioners as experts in sustainable development, community participation, and highway construction, related to the experience possessed by theoretical experts.

The researcher gets directions on the suitability in the language used in each question so that there is no bias towards the perception or opinion given. Based on the expert judgement and suitability of the theory in question in this study, the questionnaire is feasible to be distributed to respondents. From these results, if the average value of the variable is in the range of 2.5 to 5, it can be concluded that the results of expert judgment are relevant.

Preliminary survey produced an average value between 2.5 – 5, whereas the value indicates the level of relevance of the variable. From the results of the preliminary survey analysis, 20 variables were said to be relevant to be tested as Criteria for Community Participation to Achieve Sustainable Road Projects in the City of Surabaya. At this stage, the researcher conducted a survey using a questionnaire. The source of the questionnaire data was taken from the processed data from the preliminary survey which had been developed with seven pilot tests on prospective respondents. Questionnaires function as a means to collect data needed by researchers who can later be analyzed to get results in accordance with the objectives.

The survey at this stage used a sample with a population of several communities, government employees, and contractors who have participated in the process of participation in road construction in Surabaya. The respondents obtained for this study were 300. All data was collected in a period of 19 days. The collection of questionnaire data was processed using statistical methods. The results of the data were then further analyzed and interpreted in order to get results in accordance with the objectives.

From the results of the preliminary survey analysis, 20 variables were said to be relevant to be tested as criteria for community participation in achieving a sustainable highway project in Surabaya. Furthermore, all the variables that are said to be relevant in this preliminary survey were used as a reference for the implementation of the main survey. Main survey was delivered to find out the criteria that are considered the most influential for achieving a sustainable highway project in the city of Surabaya. Tests conducted to obtain these criteria are the mean test.

TABLE II. MEAN TEST

Criteria for Community Participation	Category							
	Totality		Government		Contractor		Community	
	Mean	Rank	Mean	Rank	Mean	Rank	Mean	Rank
Involve all representatives of affected communities.	4.41	1	4.3	1	4.48	1	4.42	1
The results of the participation process decisions are delivered equally to all affected communities.	4.27	2	4.12	6	4.13	9	4.36	2
The results of participation decisions can be applied in the field.	4.27	3	4.15	4	4.25	4	4.32	3
The results of the participation process decisions can be accepted by the affected communities.	4.24	4	4.23	2	4.12	10	4.28	4
Providing information that fits the needs of affected communities.	4.23	5	4.03	10	4.33	2	4.26	7

The researcher looked at the respondents' perceptions as a whole, based on the perceptions of the community, government, and the private sector. As described in Table II,

from the results of the analysis of the Mean Test it can be concluded that the five criteria with the highest ranking in the process of community participation to achieve a sustainable highway project in the city of Surabaya are:

1. Involving all representatives of affected communities, with a mean value of 4.41. The criterion was also reinforced by the perception of the government, the private sectors, and the community which also concluded that this criterion were ranked first.
2. The results of the decision on the participation process are delivered equally to all affected communities, with a mean value of 4.27. These criteria are supported by perceptions of the community category, but are not supported by the private and government categories. The government category considered that this criterion is ranked sixth, while the private category considered this criterion to be ranked ninth.
3. The results of the participation decision can be applied in the field, with a mean value of 4.27. These criteria are supported by perceptions of the community category, but not in the private and government categories. Both categories provide the fourth level for this criterion.
4. The results of the participation process decision can be accepted by the affected community, with a mean value of 4.24. This criterion is supported as the fourth highest ranking according to the community category. However, it differs from the government category which positions that this criterion ranks second highest. It is also different from the private category which considered this criterion to be not very important, with the position ranked tenth.
5. Providing information that is in accordance with the needs of affected communities, with an mean value of 4.23. According to the private category, this criterion is ranked the second highest, while according to the community category is in seventh position. Whereas according to the government category, this criterion is ranked tenth.

Based on the mean test that has been done, there were differences in perceptions of these criteria.

CONCLUSION

Based on the results of research conducted on the research "Criteria for Community Participation to Achieve Sustainable Highway Projects in the City of Surabaya" the following conclusions were obtained:

1. There are 20 criteria for measuring the criteria for community participation that can achieve a sustainable highway project in the city of Surabaya. Three highest ranking criteria to achieve a sustainable road project in the city of Surabaya are involve all representatives of affected communities, the results of the participation process decisions are evenly distributed to all affected communities, and the results of participation decisions are acceptable to affected communities.
2. There are different perceptions between categories (community, government and private sector) regarding the criteria for community participation in achieving a sustainable highway project in Surabaya. Significant differences are seen in the government and community categories. Perceptual differences that occur in certain

criteria, such as: providing information that is in accordance with the affected community, the participation process is carried out in two directions (there is a dialogue process), there are appropriate facilitators or moderators in the participation process, etc.

REFERENCES

- Aaltonen, K. and Kujalab, J., "A Project Lifecycle Perspective on Stakeholder Influence Strategies in Global Projects," *Scandinavian Journal of Management*, vol. 26, no. 4, pp. 381–397, 2010.
- Arnstein, S. (1969). A Ladder of Citizen Participation. *Journal of the American Institute of Planners*, 35, 216-224.
- Bal, Menoka., Bryde, D., Fearon, D. & Ochieng, F. (2013) Stakeholder Engagement: Achieving Sustainability in the Construction Sector . *Journal Sustainability*, 6, 695-710
- Bickerstaff, K., Tolley, R., & Walker, G. (2002). Transport Planning and Participation the Rhetoric and Realities of Public Involvement. *Journal of Transport Geography*, 10(1), 61–73.
- Blackstock, K.L., Waylen, K.A., Dunlison, J. and Marshall, K.M. (2012). Linking Process to Outcomes Internal and External Criteria for A Stakeholder Involvement in River Basin Management Planning. *Ecological Economics*, 77, 113-122.
- Budimanta, A., 2005. Memberlanjatkan Pembangunan di Perkotaan Melalui Pembangunan Berkelanjutan dalam Bunga Rampai Pembangunan Kota Indonesia dalam Abad 21. Yogyakarta : Fakultas Arsitektur
- Budimanta A, Rudito B dan Prasetyo A. (2008). Corporate social responsibility: jawaban bagi pembangunan Indonesia masa kini. Jakarta [ID]: Indonesia Business Link.
- Caribbean Natural Resources Institute (CANARI). (2004). Guidelines for Participatory Planning: A Manual for Caribbean Natural Resource Managers and Planners. UNEP Caribbean Environment Programme.
- Carr, G., Blöschl, G. and Loucks, D.P. (2012). Evaluating Participation in Water Resource Management : A Review. *Water Resource Research*, 48, W11401, doi : 10.1029/2011WR011662.
- Chan, A.P.C., Scott, D. and Lam, E.W.M. (2002). "Framework of success criteria for design/build projects". *Journal of Management in Engineering*, 18(3),120-128.
- Cohen J. M and Uphoff N. T. (1977). *Rural Development Participation: Concepts and Measures for Project Design, Implementation and Evaluation* (Ithaca NY: Rural Development Committee, Cornell University).
- Creighton, J. L. (2005). *The Public Participation Handbook: Making Better Decisions Through Citizen Involvement*. San Francisco: Jossey-Bass.
- Elkington, J. (1998). Partnerships from Cannibals with Forks : The Triple Bottom Line of 21st-Century Business. *Environmental Quality Management*, 37-51.
- Flannery, W. and Cinneide, M.O. (2012). Stakeholder Participation in Marine Spatial Planning: Lessons from The Channel Islands National Marine Sanctuary. *Society and Natural Resources* 25, 727-742.
- Freeman, R.E. (1984) "Strategic Management: A Stakeholders Approach", Fitman, Boston, hlm.37
- Ghozali, I. and Chariri, A. (2007). *Teori Akuntansi-Edisi 3*. Badan Penerbit Universitas Diponegoro. Semarang.
- Hobley, M., 1996. *Participatory Forestry : The Process of Change in India and Nepal*. Rural Development Forestry Study Guide 3. London
- Hadi, Sutrisno. 2004. *Metodologi Research Jilid 3*. Yogyakarta : Andi.
- Handayani, A. (2008). *Environmental Management in Toll Road Sector Towards Sustainable Urban Transport : A Study of Jakarta Intra Urban Toll Road, Indonesia*. MSc Thesis in Urban Management and Development, Erasmus University of Rotterdam, The Netherlands.
- International Association for Impact Assessment (IAIA) website (2017). Available: <http://www.iaia.org/>. Retrieved 25 February 2018.
- Koppenjan, J.F.M & Klijn, E.H. (2004) "Managing Uncertainties in Networks: A Network Approach to Problem Solving and Decision Making". London: Routledge
- Lawalata, G. M . (2013). "Prinsip-Prinsip Pembangunan Jalan Berkelanjutan. *Jurnal Transportasi*". Forum Transportasi Antar- Pergunungan Tinggi. Volume 13 No. 2
- Li, Terry H.Y., Ng, S. Thomas, & Skitmore, Martin (2012) Conflict or Consensus : An Investigation of Stakeholder Concerns during The Participation Process of Major Infrastructure and Construction Projects in Hong Kong. *Habitat International*, 36(2), pp. 333-342.
- Li, T.H., Ng, S.T. and Skitmore M. (2012). Public Participation in Infrastructure and Construction Projects in China: From An EIA-based to A Whole-Cycle Process. *Habitat International*, 36, 47-56.
- Li, T.H., Ng, S.T. and Skitmore M. (2013). Evaluating Stakeholder Satisfaction During Public Participation in Major Infrastructure and Construction Projects: A Fuzzy Approach. *Automation in Construction*, 29, 123-135.
- Lim, S.K. (2009). *Framework and Processes for Enhancing Sustainability Deliverables in Australian Road Infrastructure Projects*. PhD Thesis. School of Urban Development, Queensland University of Technology (QUT), Australia.
- Lim, S.K., Yang, J. (2008) Understanding the Need of Project Stakeholders for Improving Sustainability Outcomes in Infrastructure Projects. In *Proceedings of the Performance and Knowledge Management Joint CIB Conference*, Finland, Helsinki; In-house Publishing: Rotterdam, the Netherlands; pp. 332–343.
- Luyet, V., Schlaepfer, Parlange, M.B. and Buttlar, A. (2012). A Framework to Implement Stakeholder Participation in Environmental Projects. *Journal of Environmental Management*, 111, 213-219.
- Meshack, M.V. (2004). Potential and Limitations of Stakeholders' Participation in Community-Based Projects. *IDPR* 26.
- Marlina, A., 2009. *Karakteristik untuk Mendefinisikan Sustainable*, Wordpress: Jakarta
- Ng, S.T., Li, T.H.Y. and Wong, J.M.W. (2012). Rethinking Public Participation in Infrastructure Projects. *Proceedings of the Institution of Civil Engineers: Municipal Engineer*, 165 (2), 101-113.
- Ng, S.T., Wong, J.M.W. and Wong, K.K.W. (2013). A Public Private People Partnerships (P4) Process Framework for Infrastructure Development in Hong Kong. *Cities*, 31, 370-381.
- Reed, M.S. (2008). Stakeholder Participation for Environmental Management: a Literature Review. *Biological Conservation*, 141, 2417-2431.
- Rohman, M.A, Doloi, H. and Heywood, C.A. (2017). Success Criteria of PPP Toll Road Project from a Community Societal Perspective. *Built Environment Project and Asset Management*. 7 (1), 32-44.
- Sanoff, H. (2007). Special Issue on Participatory Design. *Design Studies*, 28, 213-215. doi:10.1016/j.destud.2007.02.001.
- Sekaran, Uma (2003), *Research Methods For Business: A Skill Building Approach*, New York-USA: John Wiley and Sons, Inc
- Shan, C. and Yai, T. (2011). Public Involvement Requirements for Infrastructure Planning in China. *Habitat International*, 35(1), pp.158-166.
- Silvius, A.J.G., Schipper, R. (2016) Exploring The Relationship Between Sustainability and Project Success - Conceptual Model and Expected Relationships. *International Journal of Information Systems and Project Management*, Vol. 4, No. 3, 2016, 5-22
- S.T. Ng, T.H.Y. Li, J.M.W. Wong, (2012). Rethinking Public Participation in Infrastructure Projects, *Proceedings of the Institution of Civil Engineers : Municipal Engineer*. 165 (2) (2012) 101–113.
- Soemanto, B. 2007. *Sustainable Corporation: Implikasi Hubungan Harmonis Perusahaan dan Masyarakat*. PT. Semen Gresik (Persero) Tbk. Gresik.
- Sukada, Sonny. (2007). *Membumikan bisnis berkelanjutan*. Jakarta [ID]: Indonesia Business Link.
- T.H.Y. Li, S.T. Ng, M. S., (2012) Public Participation in Infrastructure and Construction Projects in China: from An EIA-Based to A Whole-Cycle Process, *Habitat International* 36 (1) 47–56.
- Undang-Undang Republik Indonesia Nomor 22 Tahun 2009 tentang Lalu Lintas dan Angkutan Jalan
- Undang - Undang Republik Indonesia No 38 Tahun 2004 tentang Jalan
- Wheeler, S. and Beatley, T. 2004. "Introduction to Chapter 7" from *Agenda 21* (1192). And the "Istanbul Declaration on Human Settlements". *The Sustainable Urban Development Reader*. The Routledge Urban Reader Series. New York, NY.
- Wibisono, Y. (2007) *Membedah Konsep dan Aplikasi CSR*. Gresik: Fascho Publishing,
- Woltjer, J. (2002). The 'Public Support Machine' : Notions of The Function of Participatory Planning by Dutch Infrastructure Planners. *Planning Practice & Research*, 17, 437-453.

The Potential of Peanut as Primary Material for Peanut Butter Agroindustry in Indonesia

Nurfa Anisa 1)

Industrial Engineering Department,
Wisnuwardhana University, Mechanical Engineering
Department, Brawijaya University,
Malang, East Java
nurfaanisa@yahoo.co.id

Pratikto 2)

Mechanical Engineering Department,
Brawijaya University,
Malang, East Java
prawotopratikto@gmail.com

Purnomo Budi Santoso 3)

Mechanical Engineering Department,
Brawijaya University,
Malang, East Java
budiakademika@yahoo.com

Ishardita Pambudi Tama 4)

Mechanical Engineering Department,
Brawijaya University,
Malang, East Java
kangdith@gmail.com

Abstract - Indonesia is ranked in 7th (2.81%) while leading producers of peanuts; China, India, and Nigeria own 64% of the world's total peanut production. Peanuts not yet considered as superior commodity although its potential to increase farmers' income as cash crops quite enormous compared to other crops. To increase its added value a peanut processing agro-industry is proposed to be UKM (Small and Medium Enterprises) that will synergize with cooperative institutions (KUD) in peanut producer centers. From the mapping results showed that supporting factors of peanut for agroindustry in Indonesia are Land Size; Productivity; Planting/Harvesting Period; Interest of Farmers; Price; Marketing; Venture Capital; and Consumer Interest. The study problem is to which extent peanuts potentiality to be produced into peanut butter by identifying important factors that support peanuts. The data used are secondary data from BPS 2018 in time series data from 2014 to 2018. Forecast data for 2019–2021 obtained from BPS, Balitkabi, Pusdatin, and Ministry of Agriculture. The analysis methods are descriptive analysis followed by Analytical Hierarchy Process. The research conclusion is peanut potentiality can be improved by expanding plantation areas and increasing its productivity so will be adequate for peanut butter agroindustry if the production is high and consumer demand in peanut butter also high.

Keywords: Peanut potentiality, Agroindustry, Peanut Butter

JEL Classification: L

I. INTRODUCTION

Peanuts (*Arachis Hypogaea*) or known as peanut, groundnut, earthnut, pinder are plants that were first discovered in South America around 950 S. M, then developed into Africa and North America. Initially peanuts for animal feed then began to be consumed by humans around the end of the 19th century (Woodroof, 1983). Peanuts are cheap foods but are widely used as a source of nutrition by residents throughout the world. (Reese & Lehrer, 1999). On a diet program, consuming peanuts is very good because it contains a lot of nutrients and can reduce Body Mass Index (BMI) (Griehl, et al. 2014). Peanuts contain phytosterol which can reduce cholesterol and triglyceride levels, by holding back the absorption of

cholesterol from food circulated in the blood and reducing the reabsorption of cholesterol from the liver, while maintaining HDL cholesterol. As we know that cholesterol is one of the causes of heart disease. The fact is, the agricultural peanut commodities are very easily damaged and require further processing, one of the processing businesses that is easy and widely consumed by the people in their daily lives, namely by processing it into peanut butter for bread spread other types of bargains or fillers (Astawan and Wahyudi, 1991). So that it takes a company that processes agricultural commodities, called Agroindustry (Machfoedz, 2015).

Opportunities for peanut agroindustry are very bright because there are many potential resources can be optimized efficiently and effectively. Peanuts are one type of legumes that have the potential to be strategically sufficient to be developed into processed products that are oriented to agro-industry. The development of peanut agroindustry will be beneficial because of the availability of fertile land, suitable climate, and abundant labor availability. The level of demand for peanuts, which continues to increase from home and abroad, provides an important opportunity for Indonesia to fulfill this demand by developing peanuts as a superior product. In America, more than 500,000 kg/year of peanuts are produced, mostly consumed in the form of fried peanuts, peanut butter, peanut oil and various other food preparations. Today everyone in America consumes around 2,903 kg/capita/year of peanuts where half is consumed in the form of peanut butter for bread spread (USDA 2010). According to FAOSTAT 2009 data, 85% of the peanuts available in Indonesia are food items with a consumption rate of 2.4 kg/capita/year. Peanuts are consumed in the form of peanut sauce, distilled food (boiled, fried, roasted/oven); bakery products, wet and dry cakes; peanut flour; oil; and peanut butter. Thus, the availability of raw materials for peas and peanut seeds is very important related to the fulfillment of community nutrition and food security (Ginting, et al. 2015).

Based on the ranking of the world's major peanut producer countries, Indonesia ranked 7th with a market

share of 2.81% of world peanuts. The three leading producers of peanuts in the world are China, India, and Nigeria, with a share of production of almost 64% of the world's total peanut production (FAOSTAT, 2014).

In Indonesia, peanuts nationally are not yet considered a superior commodity. Whereas the potential of this plant in increasing farmers' income, as cash crops is quite enormous compared to other crops. (Sumarno, 2015).

The harvested area for peanut plants in Indonesia in 2018, around 373,000 ha which produces peanuts amounting to 512,000 tons/year with average productivity of 13.73 ku/ha. Of the ten central provinces, the cumulative production contribution of 72.55% is spread in 4 provinces, where East Java province contributes the largest or 30.39% of national peanut production. Furthermore, Central Java, West Java, and D.I Yogyakarta, contributed 18.71%, 12.18% and 11.28% respectively to national peanut production. The other six provinces, namely, West Nusa Tenggara, South Sulawesi, East Nusa Tenggara, Banten, South Kalimantan, and North Sumatra, contributed under 6% to national peanut production. (BPS, 2018). Considering that rice fields and peanut fields in Indonesia belong to the people, then the regions that produce the biggest peanuts should think of increasing the added value of peanuts which can have an impact on increasing people's incomes, especially peanut farmers. In other words, not only think of on-farm but also off-farm. One of the biggest peanut producing regions in Indonesia is Tuban Regency, East Java with five biggest producing sub-districts, namely Tuban, Merakurak, Palang, Semanding, and Kerek Districts. According to 2018 statistics, Tuban has a harvest area of around 21,000 - 28,000 ha. The average yield of crops is 3.0 - 4.5 tons/ha. The peanuts planted are Spanish type with an average planting period of 90 - 95 days, with a spacing of 40 cm x 10 cm (1 seed/hole). In the 2018 harvest of superior varieties Hypoma 1 was launched to be planted, where Hypoma 1 is a crossing of local varieties of Tuban and local varieties of Lamongan. Hypoma 1 is in great demand by Agroindustry because of its high production, can increase production of 1-2 tons/ha and good quality. Because of the geographical location of Tuban Regency near the sea, the land contains salt, thus making the taste of peanuts to be naturally savory. (kabartuban.com)

Marketing peanut crops in Tuban area currently deposited to two crunchy bean factories in Pati, Central Java which are the Dua Kelinci and the Garuda (Garuda Food) bean factories. When demand from these two companies become less or decreases then peanut price at the farmer level will also goes down. The marketing from peanut crop depends on these two companies. The price of wet skin beans from farmer is purchased at average price of IDR 8,000/kg. When there is a price decline, peanuts are only purchased at IDR 5,500/kg, although with this price they don't lose, IDR 5,500 /kg as selling price is enough to cover production cost although can bring only very little profit. Moreover, at the moment of grand harvest usually make the price also falls due to abundant stock of peanuts, but without or not much demand from these two crunchy bean factories. As a result, instead of rotting many farmers sell these peanuts at low price in the market (Kabupaten.go.id)

From existing fact above, it should be become a thought to establish a stable groundnut price because agriculture commodity of wet peanut are not resistant to storage, easily get rotten or spoiled and prone to mold. Then the best solution for these problems is to make the peanut commodity being processed so it will stay longer or has durability during storage time. One of the best solutions is to establish a peanut processing agroindustry which aims to increase the added value of peanuts so that the farmers' incomes increase and able to open new jobs to make unemployed workers are absorbed.

The reason for choosing peanut butter processing agro-industry in this study refer to the fact that peanut butter is consumed by Indonesians every day as a spread of fresh bread or for mixed ingredients to make other food preparations. So peanut butter has almost become daily staple food for Indonesian. This is a good prospect for establishing a peanut butter agroindustry because demand will constantly exist. Another reason is that the process of making peanut butter is including simple because it does not require complicated and expensive machinery and equipment.

Considering the institutional aspect of agro-industry that will be established is very important then to do a study on this matter is necessary, with a proposal idea to make one cooperative organization in the form of Village Unit Cooperatives (KUD) that will be synergized with peanut processing agro-industries into SME scale peanut butter (Small and Medium Enterprises) in peanut producer centers. The cooperative institutions are chosen because cooperatives are institutions that align with the personality of the Indonesian nation based on family principles. Cooperatives also have the potential to encourage economic development and reduce poverty (Bybby, 2005 and Birchall, 2013). The primary reason for choosing a cooperative is because cooperatives are business models that offer solution in terms of capital or financing solution to support those who pioneering a new business that does not have large financial strength, then it can be anticipated by the form of cooperation in starting a business in the form of cooperatives (Bhuyan and Olson, 1997). In addition to these advantages cooperatives as a form of business can enable Small and Medium Enterprises (SMEs) to strengthen their position in the market (Masurel and Jansen, 1998), and when using cooperatives allow members to survive independently and be able to compete in the relevant market.

As aforementioned for the background of this research plan, an overview of the largest peanut producing areas in Indonesia has been given, namely Tuban Regency. However, this area has not shown a significant impact on increasing farmers' income. This impact was experienced because of several factors, including institutional, technological, capital, and synergy between agro-industry actors and farmers.

Based on this fact, the purpose of this study was to determine the extent of the feasibility of peanuts to be made into peanut butter agroindustry. It is hoped that the benefits of this research will be a source of information for businesses in several peanut production centers in Indonesia

to implement peanut butter agroindustry development to increase the value of peanuts and improve community welfare through increased income.

II. LITERATURE REVIEW

At present, peanut productivity in Indonesia in average is 1.35% tons/hectare. China and the United States have productivity of 3.61% tons/hectare and 4.73 tons/hectare. This still opens opportunities for Indonesia to increase its productivity.

There were fourteen varieties (Table 1) with productivity above 3 tons/hectare released by Puslitbangtan until 2009 (Puslitbangtan, 2009). In 2010-2012 five new varieties were released with the productivity of more than 3 tons/ha (Kasno, 2014). Until today, nineteen varieties have been released with potential yield above 3 tons/ha, these varieties numbers show that Indonesia has great a potential in increasing the productivity of peanuts to increase domestic production. Until 2014, thirty-seven peanut varieties had been released in Indonesia but only fewer varieties found in the field. The increase of production or sustainable productivity depend on the success of developing superior varieties (Purnomo, J. and Harnowo, D. 2015).

Table 1. Superior Peanut Varieties

No	Name	Pod (seed)	Average yield (ton/h)	Potential harvest (ton/h)	Harvesting age (days)	Seeds (gr/100 seeds)
1.	Kelinci (87)	4	2,3	4,3	95	45
2	Jerapah (98)	2	1,92	4	90-95	45-50
3	Kancil (01)	2	1,7	3,5	90-95	35-40
4	Tuban (03)	2	2	3,2	90-95	35-38
5	Talam 1 (10)	2	2,3	3,2	90-95	50,3
6	Hypoma 1 (12)	2	2,3	3,7	91	36,4
7	Hypoma 2 (12)	2	2,4	3,5	90	31,2
8	Takar 1 (12)	2	3	4,25	90-95	65,5
9	Takar2 (12)	2	3	3,8	85-90	47,6
10	Garuda 5 (13)	2	2,84	3,5	85-96	36,4
11	Talam 2 (14)	2	2,5	4	90-95	43,4
12	Talam 3 (14)	2	2,6	3,7	90-95	38,0
13	Tala 1 (16)	2	2,62	3,23	85	35,0
14	Tala 2 (16)	2	2,61	3,11	90-95	42,7

Source: Leaflets-Varieties, Balitkabi 2016

The fat content of peanuts is quite high, around 47.7%. The peanut fat content is highest among all types of beans, even with several other food crop commodities (Table 2).

Table 2. Nutrient Content of Peanuts and Various Food Ingredients (per 100 grams)

Commodity	Water(g)	Protein (g)	Carbohydrate (g)	Fat (g)	Fiber (g)
Rice	12	7,5	77,4	1,9	0,9
Corn	10	10	70,0	4,5	2,0
Taro (Bulbs)	70	1	26,0	-	1,5
Cassava (tuber)	62	1,8	92,5	0,3	2,5
Tubers(bulbs)	70	5,0	85,8	1,0	3,3
Soybean	10	35,0	32,0	18,0	4,0
Peanut	5,4	30,4	11,7	47,7	2,5
Green Beans	10	22,0	60,0	1,0	4,0

Source: Purnomo and Purnamawati (2007)

The contribution of peanut commodities from several provinces in the country for last five years is seen in terms of area dispersal within ten provinces with a contribution of 88.41% of the total harvested area of peanuts in Indonesia. Of the ten central provinces, the four largest provinces are in the Java region with a contribution of 70.91% or an average area of 87.10 thousand hectares. East Java is the province with the largest peanut harvest area, where the average harvested area reaches 144.59 thousand hectares, contributing 29.43% to the average national harvest area. Central Java ranked second with an average harvest area of 88.74 thousand hectares, contributing 18.06% to the average national harvest area. The 3rd and 4th rank are D.I. Yogyakarta, and West Java with contributions of 13.56 % and 9.86% respectively to the national harvest area. Six other central provinces with contributions each below 6% of the national harvest area (Figure 1).

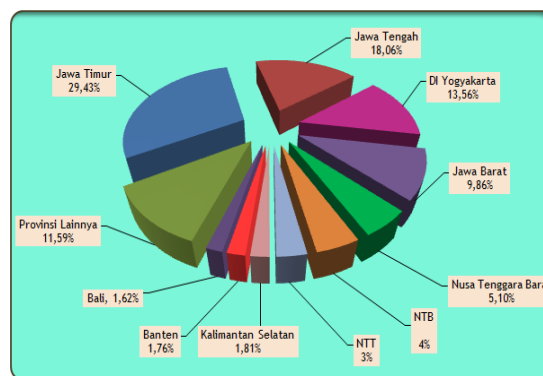

Fig. 1. Province of Central Peanut Harvest Area in Indonesia from 2011-2016

Source: Pusdatin Pertanian-Ministry of Agriculture 2016

From its productivity aspect, over the past five years the highest productivity average was in West Java 16.30 ku/ha, 2nd ranked Gorontalo 16.07 ku/ha, and 3rd and 4th ranked West Sumatra and West Nusa Tenggara, respectively 14.40 ku/ha. The highest productivity growth per hectare is in West Java, which is 3.54% per year, and the regions with the lowest productivity growth are Gorontalo and West Sumatra with an average growth of minus 2.26% per year and minus 0.69% per year (Figure 2).

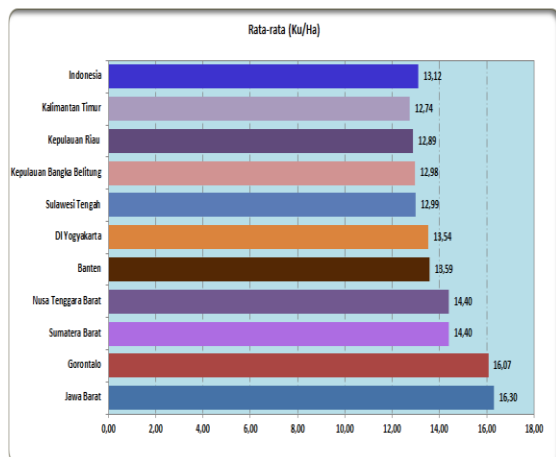

Fig 2. Highest Peanut Productivity in the Indonesian Province from 2011-2016
Source: Pusdatin Pertanian, Ministry of Agriculture 2016

Of the ten central provinces, the cumulative production contribution of 72.55% is spreaded within four provinces, where East Java contributes the largest 30.39% of national peanut production following by, Central Java, West Java, and D.I Yogyakarta, contributed 18.71%, 12.18% and 11.28% respectively to national peanut production. The other six provinces, namely West Nusa Tenggara, South Sulawesi, East Nusa Tenggara, Banten, South Kalimantan, and North Sumatra contributed under 6% to national peanut production. During the last five years, only two central provinces experienced an increase in peanut production, namely D.I. Yogyakarta and South Sulawesi each with an increase of 3.88% and 6.01% per year. Eight other central provinces experienced a decline in their peanut production. The highest decline in production occurred in North Sumatra at 15.25% per year, then East Nusa Tenggara with a decrease of 12.79% per year, other provinces experienced a decrease below 7% per year (Figure 3).

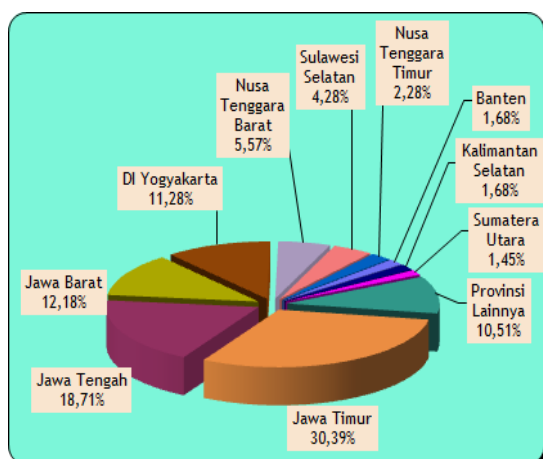

Fig 3. Center for Peanut Production in Indonesia from 2011-2016
Source: Pusdatin Pertanian, Ministry of Agriculture 2016

The development of peanut prices in the form of pods in both producer and consumer prices in the past 30 years and the last ten years has tended to increase (Figure

4). In 2011-2015 the average price growth rate at the producer and consumer level was 6.61% per year and 11.87% per year, with a margin difference of IDR 5,015.00 to IDR 9,793.00. In 2008 the price of peanut producers fell to IDR 8,084.00 per kg, this price reduction rate of 5.05% from 2007 was the lowest growth. The highest growth in 2000-2015 at the producer level was occurred in 2007, increased by 14.15% from the previous year, while in 2015 it increased by 10.46% compared to the previous year. In 2015 the costumer price was increased by 25.83 % when compared to the price in the previous year from IDR 18,495.00 to IDR 23.272.00. The high price of peanuts was caused by an increase in demand, which unfortunately had not been matched by domestic production.

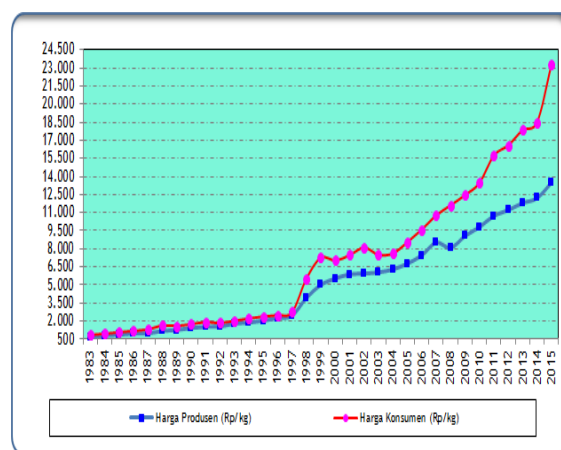

Fig 4. Developments in producer prices and consumers of peanuts in Indonesia from 1983-2014
Source: Pusdatin Pertanian, Ministry of Agriculture 2016

The development of the volume of peanut import exports from 1980-2015 is presented in Figure 5. In the 1980-2015 period, the volume of peanut imports fluctuated sharply at several points with a tendency to continue to rise until 2013. During 2011-2015 developments showed that it has an average tendency of higher import volume than export volume. The development of peanut export in 2011-2015 experienced volume of peanut exports reached an average of 3.39 thousand tons while the volume of imports reached 235.81 thousand tons.

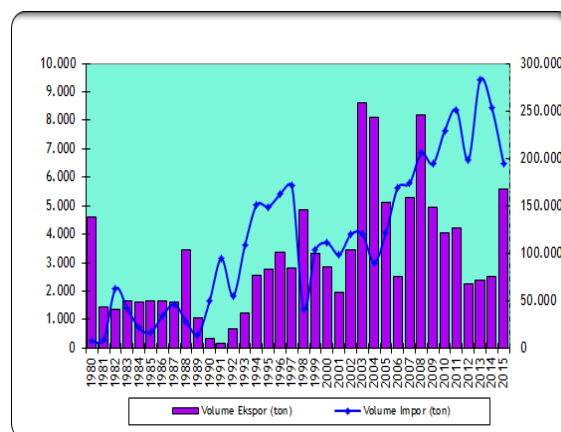

Fig 5. Development of the Volume of Export of Peanut Imports in Indonesia from 1980 - 2015

Source: Pusdatin Pertanian, Ministry of Agriculture 2016

According to the Susenas results, the national consumption of peanuts can be obtained from the multiplication of consumption per capita per year multiplied by the number of residents in the middle of the year. In 2006-2015, national consumption of peanuts fluctuated with a downward trend, where the average national consumption of peanuts was 74.03 thousand tons, while in the 2011-2015 period averaged 57.38 thousand tons. The growth of national peanut consumption in 2006-2010 has increased by 0.19% per year while 2011-2015 has decreased by 5.35% per year.

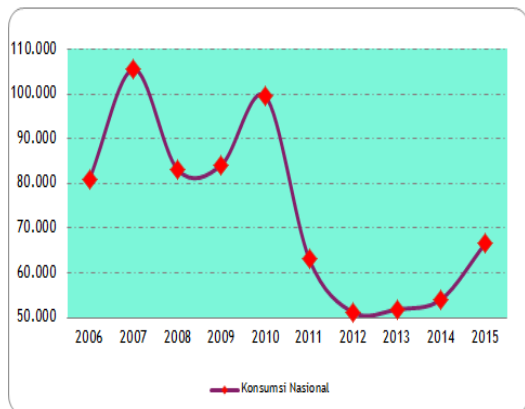

Fig. 6. Development of National Consumption of Peel Peanuts in Indonesia from 2006 - 2015

Source: SUSENAS

Data about consumption of peanuts can be obtained from Susenas or from the Food Balance Sheet (*Neraca Bahan Makanan* or NBM) from the Food Security Agency (*Bahan Ketahanan Pangan* or BKP). According to NBM, direct consumption of peanuts can be calculated by multiplying the availability of peanuts per capita and the population.

Definition of availability according to NBM is the difference in production plus imports, minus exports, scattered, seeds and for the industry.

The development of peanut availability per capita in Indonesia from 1993-2014 based on NBM fluctuated sharply with a tendency to continue to decline (Figure 7). In 1993-2014, the highest availability of per capita occurred in 1995, which was 3.98 kg/cap/year. However, per capita availability tends to continue to decline. During 2010-2014, the average per capita availability of peanuts was around 2.87 kg/cap/year. This availability figure tends to decrease with a growth rate of minus 4.11% annually.

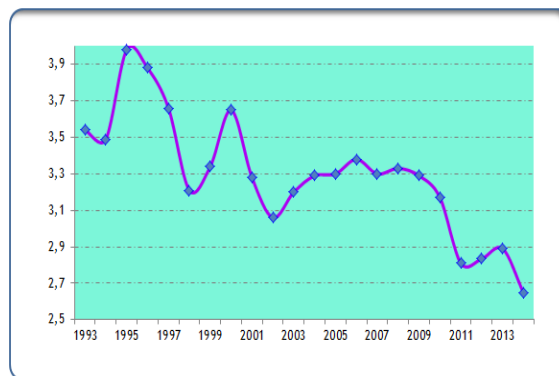

Fig 7. Development of Availability of Per Capita Peanuts in Indonesia from 1993 - 2014

Source: SUSENAS

According to data of the use and supply of peanuts in Indonesia taken from the Food Balance (NBM) data, domestic supply is the production of peanuts in the form of loose skin peanut plus import value, plus stock changes and minus exports. Domestic use includes the use of peanut as seeds (loose skin), processed for food (with skin + loose skin) and non-food (loose skin), eaten directly (off the skin) and scattered peanut in the form of skin or loose skin. The biggest use of peanuts in 1993-2014 is as food ingredients or consumed directly in the form of loose skin which reaches an average of 83.99% of domestic supply, while the use of industrial sectors, namely peanuts processed further into other products both food and non-food only reached 7.40%. The use of seeds and lost due to scattered respectively by 3.63% or 31 thousand tons and 4.98% or 42 thousand tons. In 2001-2013, the use of peanuts consumed directly (off the skin) was lower than the products produced. Different conditions occurred between 1993-1997 and 1999-2000, where domestic peanut shell consumption was higher than domestic peanut production, and so in 2013-2014 the consumption of off-skin peanuts was higher than domestic production.

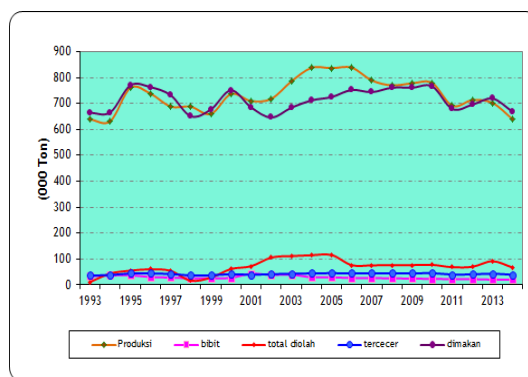

Fig 8. Development of the Use of Indonesian Peanuts from 1993-2014

Source: SUSENAS

National consumption of peanuts in 2014 fell by 7.15% from the previous year, amounting to 719.08 thousand tons. The average consumption of peanut in the last five years amounted to 703.70 thousand tons; this is far

greater than the average national consumption of peanuts in the previous two decades, which was only 552.81 thousand tons. The average growth in national consumption of peanuts in the period 2011-2015 decreased by minus 2.38% per year.

The development of domestic peanut consumption in 2000-2014 tends to fluctuate. The lowest domestic consumption in 2002 was 644.85 thousand tons, while the highest domestic consumption in 2009 was 758.78 thousand tons. Consumption in 2011 fell sharply compared to 2010, with a decrease of minus 10.07%, where the domestic consumption of peanuts amounted to 679.99 thousand tons (Figure 9).

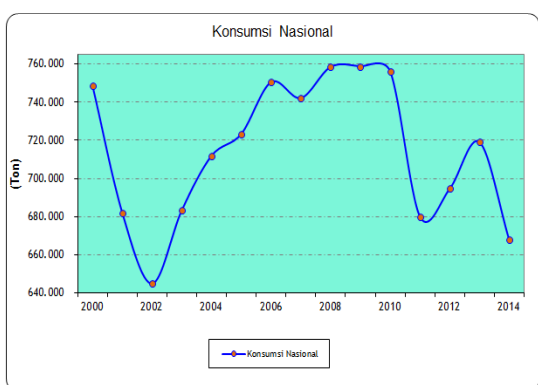

Fig 9. Development of National Consumption of Peanuts in Indonesia Based on NBM from 2000 - 2014
Source: NBM

When we compare the national consumption of peanuts based on Susenas and NBM, the most appropriate is NBM because in the NBM consumption is based on the availability of peanuts per capita per year, taking into account the use of peanuts for export, seeds, scattered for food and non-food industry.

Table 3. Production, Harvest Area, and Productivity of Peanuts in Indonesia 2014-2018

Year	Production (thousands of tons)	Harvest Area (thousands of ha)	Productivity (ku/ha)
2014	639	499	12,79
2015	605	454	13,33
2016	570	436	13,07
2017	495	374	13,23
2018	512	373	13,73

Source: BPS, processed by the Agriculture Education Center, Ministry of Agriculture

Table 4. Projections of Production, Harvest Area, and Peanut Productivity Indonesia 2019-2021

Year	Production (thousands of tons)	Harvest Area (thousands of ha)	Productivity (ku/ha)
2019	415	297	13,66
2020	358	252	13,74
2021	298	204	13,83

Source: BPS, processed by the Agriculture Education Center, Ministry of Agriculture

Table 5. Projection of Peanut Consumption in Indonesia 2019-2021

Year	Availability per capita (kg/capita/year)	Total Population (thousands)	Projected consumption (tons)
2019	2,36	267.974	633.322
2020	2,29	271.066	621.227
2021	2,22	273.984	608.114

Source: BPS, processed by the Agriculture Education Center, Ministry of Agriculture

III. METHODOLOGY

1. The methods in this research is the descriptive method that is to analyze the state of the object in the study that exists at present based on the facts that exist. The data used are secondary data from BPS 2018 in the form of time series of data for 2014 - 2018. Forecast data for 2019 -2021. These data were obtained from the Central Bureau of Statistics (BPS), Research Institute for Peanut and Bulb Plants (Balitkabi), Center for Agriculture Data and Information (Pusdatin), Ministry of Agriculture.

2. The analytical method used in this study is descriptive analysis that is to analyze the state of the object in the research that exists at present based on existing facts. Which includes the variables of land area, productivity, production, consumption, export-import, and prices at the producer level and the consumer level, a descriptive analysis is prepared. Then the next analysis uses the Analytical Hierarchy Process (AHP) method, where this method is used to analyze the priority scale determination of essential factors that will be used in determining the availability of peanuts to be used as peanut butter agroindustry. The series of AHP analysis stages and their formulations can be used in analyzing priority weighting. To get more accurate results, in this study, AHP analysis was carried out with the help of *Expert Choice program 11*.

IV. RESULT AND ANALYSIS

A. Result

The availability of peanuts to be made into peanut butter agroindustry is certainly influenced by a lot of factors. The variables: Land Area, Productivity, Harvest/Planting Period, Farmer Interest, Price, Farming Capital, Marketing, Consumer Interest for the consumption of peanut butter are factors that influence the production and availability of peanuts to be made into peanut butter agroindustry. It is necessary to analyze the variables and indicators that influence the availability of peanuts for peanut butter agroindustry, as well as the relationship between one variable to another variables, also the relationship of variables with indicators. The operational explanations of each variable and indicator are obtained from Monograf Balitkabi, 2015; Department of Forestry and Estate Crops, 2010a, Department of Forestry and Estate Crops, 2010b, Puslitbangtan, 2009 and

(<https://www.cnnindonesia.com>. Those variables are as follow:

a. Variable Area of Land (X1)

Peanut seeds are currently relatively expensive (IDR. 15,000/kg) and the needs are large (95-100) kg/ha, many are grown singly (monoculture) rather than intercropping. To change the cropping patterns is difficult hence the possible way is to expand land area.

1. New Land Indicator (X1.1)

Providing and allocating new farmland designations for 5,000 to 1 million hectares for peanut farming.

2. Indicator of Former HGU Land (X1.2)

The former land of HGU (Cultivation Right) abandoned plantations can be distributed to small farmers.

3. Indicators of the Plantation Area (X1.3)

According to Statistics, there are 2.48 million hectares of young oil palm and 0.75 million hectares of young rubber commonly called Non-Producing Plants (TBM) spread throughout Indonesia. This young plantation area can be utilized before the canopy covers the surface.

4. Rice Field Indicator (X1.4)

Irrigated rice fields and rainfed rice fields with good management of water resources can maximize the productivity of peanuts.

5. Dryland Indicator (X1.5)

Dry land wet climate rainfall of 2,000 mm/year with planting season greater than 180 days and dry climate dry land 2,000 mm/year rainfall with smaller planting seasons 180 days can be used for peanut farming.

6. Tidal Land Indicator (X1.6)

Lowlands with poor drainage during cropping season can be used for peanut farming.

7. Highland Land Indicator (X1.6)

Highlands with a height of more than 700 meters above sea level can be used for peanut farming.

b. Variable Productivity (X2)

From the research, the productivity of 2.5 tons/ha to 3 tons/ha can be theoretically achieved in Indonesia, but in reality, the scale of business productivity has not been achieved. So there must be an effort to increase productivity so that production also rises.

1. Indicator of Superior Varieties (X2.1)

The government has released 19 superior varieties with a potential yield of 3 tons/ha effort to increase the productivity of peanuts.

2. Indicators of Control of Plant Disturbing Organisms (OPT) (X2.2)

Eradicating pests and diseases, controlling weeds, avoiding aflatoxin (poison of peanuts caused by fungi) is an attempt to increase productivity.

3. Indicators of Appropriate Technology (X2.3)

The IAARD has established the Institute for Agricultural Technology Studies (BPTP) to provide location-specific appropriate technological innovations in their respective regions.

4. Integrated Crop Management Technology (PTT) Indicators (X2.4)

Location-specific PTT technology innovation is a great potential to increase productivity with a target of 2 tons / ha

in 2014 and 2.5 tons / ha in 2010. PTT components are two, namely Basic Technology and Choice Technology.

5. Indicators of Guidance and Counseling (X2.5)

Guidance and counseling about quality standards and business management to farmers are needed to increase productivity.

6. Production Technology Indicators (X2.6)

Mastery of selected production and mechanization technology is needed by farmers in conducting peanut farming, this is expected to increase productivity so that production will increase as well.

c. Harvest Variable (Planting Period) (X3)

Peanuts can grow throughout the year in a variety of different soil conditions. One important factor in planting peanuts is determining the time. Harvesting will be good if you know the right planting time.

1. Planting Season Indicator (X3.1)

The planting season on dry land is good at the beginning of the rainy season (October-December) and the end of the rainy season (January-March). And on rice fields (dry season I, II, III).

2. Indicator of Planted Varieties (X3.2)

The varieties that have been released can be harvested between 85-110 days. But to get the expected results, the age of peanut harvest is adjusted to consumption needs.

3. Plant Rotation Indicator (X3.3)

A location is not appropriate if three consecutive years are planted with peanuts, there must be a rotation with other plants, to prevent explosions of pests and diseases, fertilizer efficiency, reduce weeds. Every year a crop rotation should be held.

4. Intercropping Indicator (X3.4)

Utilizing land per unit area and time for efficient use of water in the soil and rainfall, planting two plants simultaneously (intercropping) is mostly done by farmers in the fields. Intercropping usually with corn and cassava.

5. Monoculture Indicator (X3.5)

Dryland with wet months of less than three months per year, corn plants can be replaced by planting monocultures with the production of 100% peanuts.

d. Variable Interest of Farmers (X4)

Peanut is a cash crop for small farmers, like peanuts that been developed in Indonesia are planted on land where farmers are poor. This will increase the interest of farmers to grow peanuts.

1. Price indicators are higher than corn and soybeans (X4.1)

The fact that the income of planting peanuts is higher than planting soybeans and corn, as evidenced in 1999-2002 income per hectare for corn was IDR 132,159.00, soybean IDR 326,000.00, peanuts IDR 3,060,000.00.

2. Partnership Indicators (X4.2)

Farmers will be highly interested in planting peanuts if there are company partners who will buy the results.

e. Price Variable (X5)

The price of peanuts surged along with the commemoration of religious holidays and the new year. In this period, the shortage of peanuts was closed with imports, but this import was also limited to 20% so as not to damage the price of domestic peanuts, so that price spikes could be reduced.

1. Harvest Pattern Indicators (X5.1)

At harvest time (February-June) prices are rather cheap and during harvest time the stock decreases, and the shortfall is closed with imports so prices are stable, because the needs are still sufficient, not until the shortage / rare peanuts.

2. Pod Quality Indicator (X5.2)

Prices of pods that are old (old enough) will be good. Too young or too old the price is not good, because the quality of the pods is not good.

f. Business Capital Variable (X6)

With the assumption that peanut agroindustry will be realized, the support of capital requirements or investments in peanut development and the application of technology is absolutely necessary. Capital and credit subsidies from the government will raise capital for peanut farming.

1. Government Subsidy Indicators (X6.1)

Government subsidies in the form of seeds, fertilizers, pesticides, and alsintan (tools and agricultural machinery) will increase capital.

2. Business Credit Indicator (X6.2)

Giving soft business credit with a simple administration from the government will increase capital.

g. Marketing Variables (X7)

The distribution of costs and benefits between peanut agribusiness market participants is relatively evenly distributed, this indicates that the market mechanism for the peanut market works efficiently.

1. Marketing System Indicators (X7.1)

The general peanut marketing system at the farm level is twofold, namely, the Free System is that farmers are free to sell directly anytime and to anyone who gives a high price and the Contract of Sale System (partnership) is a farmer and the buyer has made a sale and purchase agreement peanuts planted.

2. Chain Marketing Indicator (X7.2)

The marketing chain of peanuts depends on the form consumed and the market participants involved (farmers, traders (village, sub-district, district), wholesalers (wholesalers), craftsmen, processing industries, and retailers). This will affect good and smooth marketing.

h. Variable Consumer Interest for Consumption of Peanut Butter (X8)

Public awareness of healthy lifestyles, leads them to choose healthy foods too, including by choosing low cholesterol foods, because they know that cholesterol causes heart disease and degenerative diseases.

1. Benefit Indicators (X8.1)

Many benefits of peanuts for the health and beauty of the human body.

2. Nutrition (X8.2)

Peanuts contain omega 3 polyunsaturated fats and proteins and omega 9 monounsaturated fats which are good for the human body. Peanuts contain phytosterol which lowers cholesterol and triglyceride levels in the blood.

i. High Production Variable (Y1)

Peanut production in Indonesia can increase by increasing land area and increasing its productivity by 2.5-3 tons/ha of dried pods.

1. Indicator of land area (Y1.1)

Changing cropping patterns is a difficult thing, so it is possible to increase peanut production by increasing the area of land/planting area

2. Productivity Indicator (Y1.2)

Increasing productivity of 2.5-3 tons/ha is a way to increase peanut production in Indonesia.

j. Feasibility variable peanut for agroindustry peanut butter (Y2)

The feasibility of peanuts for peanut butter agroindustry if the production is high and consumer interest in consuming high peanut butter.

1. High Production Indicator (Y2.1)

Peanut production in Indonesia can increase by increasing land area and increasing its productivity by 2.5-3 tons / ha of dried pods.

2. Consumer Interest Indicator (Y2.2)

Public awareness of healthy lifestyles, leads them to choose healthy foods too, including by choosing low cholesterol foods, because they know that cholesterol causes heart disease and other degenerative diseases.

B. Analysis

To find out the priority factors, researchers employed statistical analysis with the Analysis Hierarchy Process (AHP) method using these factors. The results of the analysis can be described as follows:

1. Main Priority Factors for the Availability of Peanuts

The main factors that can influence the availability of peanuts include Land Area (X1), Productivity (X2), Harvest (Planting Period) (X3), Farmer Interest (X4), Price (X5), Business Capital (X6), Marketing (X7), and Consumer Interest (X8). The results of the analysis using AHP are obtained as follows:

Table 6. Main Priority Factors for the Availability of Peanuts

No.	Alternative	Priority values
1	Land Area (X1)	0.332
2	Productivity (X2)	0.227
3	Harvest (Planting Period) (X3)	0.131
4	Farmer Interest (X4)	0.056
5	Price (X5)	0.077
6	Business Capital (X6)	0.082
7	Marketing (X7)	0.050
8	Consumer Interest (X8)	0.045

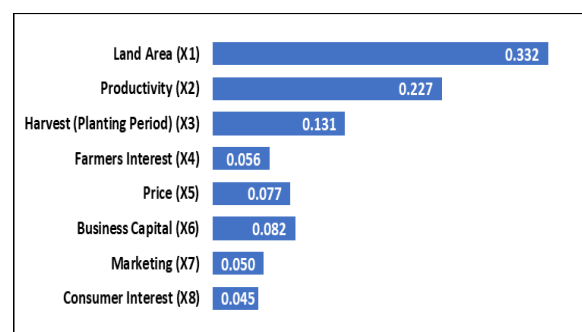

Fig 10. Main Priority Factors for the Availability of Peanuts

From the tables and figures, it can be seen that the Land Factors of Former HGU (X1.2) and Factors of Plantation Area (X1.3) are the main priority factors that can affect the availability of peanuts on the land area factor.

a. Priority Factors on Land Area

Indicators that can affect land area include New Land (X1.1), Former HGU Land (X1.2), Young Plantation Area (X1.3), Paddy Field (X1.4), Dry Land (X1.5), Tidal Land (X1.6), and Highland Land (X1.7). The results of the analysis using AHP are obtained as follows:

Table 7. Priority Factors on Land Area

No.	Alternative	Priority Value
1	New Land (X1.1)	0.070
2	Former HGU Land (X1.2)	0.244
3	Plantation Area (X1.3)	0.186
4	Rice Field (X1.4)	0.149
5	Dry Land (X1.5)	0.110
6	Tidal Land (X1.6)	0.131
7	Highland Land (X1.7)	0.110

Source: Tabulation Data

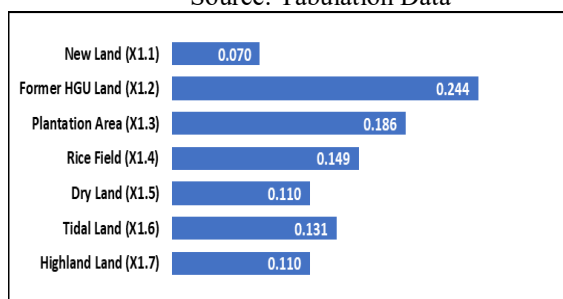

Fig 11. Priority Factors on Land Area
Source: Tabulation Data

From the tables and figures, it can be seen that the Land Factors of Former HGU (X1.2) and Factors of Plantation Area (X1.3) are the main priority factors that can affect the availability of peanuts on the land area factor.

b. Priority Factors Against Productivity

Indicators that can affect productivity include Superior Varieties (X2.1), Control of Plant Disturbing Organisms (OPT) (X2.2), Appropriate Technology (X2.3), Integrated Crop Management Technology (PTT) (X2.4), Guidance and Counseling (X2.5), and Production Technology (X2.6). The results of the analysis using AHP are obtained as follows:

Table 7. Priority Factors Against Productivity

No	Alternative	Priority Values
1	Superior Varieties (X2.1)	0.452
2	Control of Plant Pest Organism (OPT) (X2.2)	0.040
3	Appropriate Technology (X2.3)	0.209
4	Integrated Crop Management Technology (PTT) (X2.4)	0.119
5	Guidance and Counseling (X2.5)	0.073
6	Production Technology (X2.6)	0.106

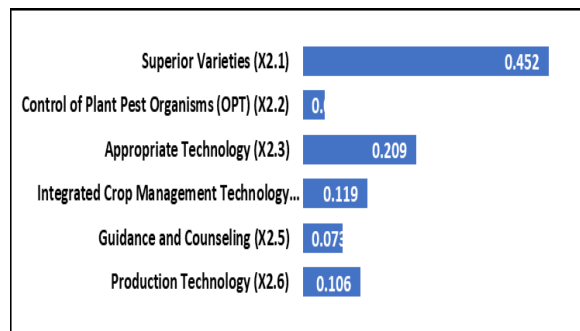

Fig 12. Priority Factors Against Productivity
Source: Tabulation Data

From the tables and figures, it can be seen that the Superior Variety factor (X2.1) and Appropriate Technology factor (X2.3) are the main priority factors that can affect the availability of peanuts on productivity factors.

c. Priority Factors Against Harvest (Planting Period)

Indicators that can affect harvest (planting period) include Planting Season (X3.1), Planted Varieties (X3.2), Crop Rotation (X3.3), Intercropping (X3.4), and Monoculture (X3.5). The results of the analysis using AHP are obtained as follows:

Table 8. Priority Factors Against Harvest (Planting Period)

No.	Alternative	Priority Values
1	Planting Season (X3.1)	0.172
2	Planted Varieties (X3.2)	0.602
3	Crop Rotation (X3.3)	0.110
4	Intercropping (X3.4)	0.054
5	Monoculture (X3.5)	0.061

Source: Tabulation Data

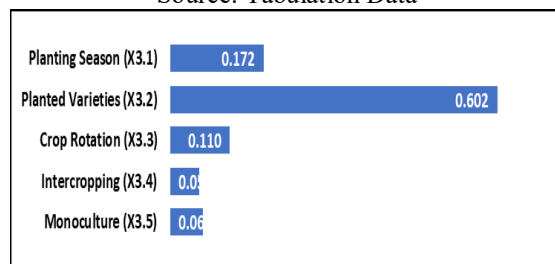

Fig 13. Priority Factors Against Harvest (Planting Period)
Source: Tabulation Data

From the tables and figures, it can be seen that the Planted Varieties (X3.2) and Planting Season factors (X3.1) are the main priority factors that can affect the availability of peanuts on the harvest /planting period.

d. Priority Factors Against Farmers Interest.

Indicators that can affect farmers' interest include prices higher than corn and soybeans (X4.1) and partnerships (X4.2). The results of the analysis using AHP are obtained as follows:

Table 9. Priority Factors Against Farmers Interest

No.	Alternative	Priority Values
1	Prices higher than corn and soybeans (X4.1)	0.833
2	Partnerships (X4.2)	0.167

Source: Tabulation Data

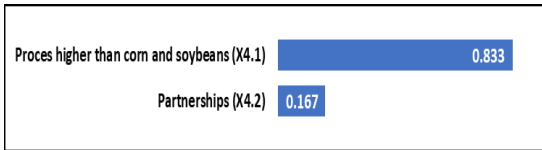

Fig 14. Priority Factors Against Farmers Interest
Source: Tabulation Data

From the tables and figures, it can be seen that the price factor is higher than corn and soybeans (X4.1) is the main priority factor that can affect the availability of peanuts in the interest of farmers.

e. Priority Factors Against Prices

Indicators that can affect prices include Harvest Pattern (X5.1) and Pod Quality (X5.2). The results of the analysis using AHP are obtained as follows:

Table 10. Priority Factors Against Prices

No.	Alternative	Priority Values
1	Harvest Pattern (X5.1)	0.750
2	Pod Quality (X5.2)	0.250

Source: Tabulation Data

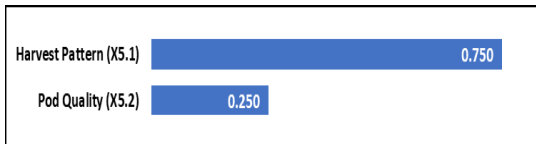

Fig 15. Priority Factors Against Prices
Source: Tabulation Data

From the tables and figures, it can be seen that the Harvest Pattern factor (X5.1) is the main priority factor that can affect the availability of peanuts at the price.

f. Priority Factors Against Business Capital

Indicators that can influence business capital include Government Subsidies (X6.1) and Business Loans (X6.2). The results of the analysis using AHP are obtained as follows:

Table 11. Priority Factors Against Business Capital

No.	Alternative	Priority Values
1	Government Subsidies (X6.1)	0.875
2	Business Loans (X6.2)	0.125

Source: Tabulation Data

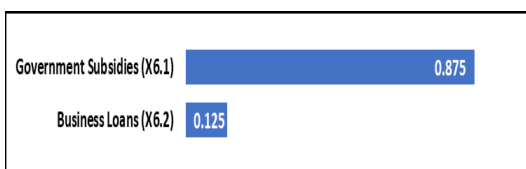

Fig 16. Priority Factors Against Business Capital

From the tables and figures, it can be seen that the Government Subsidy factor (X6.1) is the main priority factor that can affect the availability of peanuts on venture capital.

g. Priority Factors Against Marketing

Indicators that can influence marketing include the Marketing System (X7.1) and the Marketing Chain (X7.2). The results of the analysis using AHP are obtained as follows:

Table 12. Priority Factors Against Marketing

No.	Alternative	Priority Values
1	Marketing System (X7.1)	0.875
2	Marketing Chain (X7.2)	0.125

Source: Tabulation Data

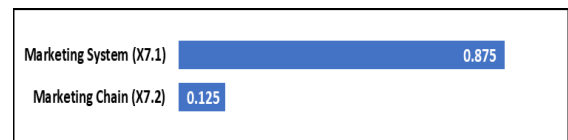

Fig 17. Priority Factors Against Marketing
Source: Tabulation Data

From the tables and figures, it can be seen that the Marketing System factor (X7.1) is the main priority factor that can affect the availability of peanuts in marketing.

h. Priority Factors Against Consumer Interest

Indicators that can influence consumer interest include Benefits (X8.1) and Nutrition (X8.2). The results of the analysis using AHP are obtained as follows:

Table 13. Priority Factors Against Consumer Interest

No.	Alternative	Priority Values
1	Benefits (X8.1)	0.250
2	Nutrition (X8.2)	0.750

Source: Tabulation Data

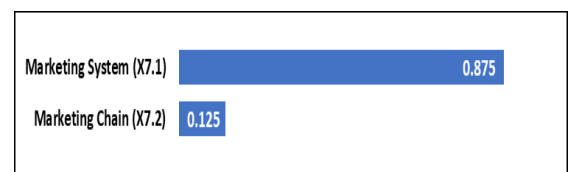

Fig 18. Priority Factors Against Consumer Interest
Source: Tabulation Data

From the tables and figures, it can be seen that the Nutrition Factor (X8.2) is the main priority factor that can influence the availability of peanuts on consumer interest.

V. CONCLUSION AND RECOMMENDATION

A. Conclusion

Based on the findings in this study it can be concluded that peanut potentiality as primary material for peanut butter agroindustry is having great opportunity to be developed in Indonesia as starter for peanut butter agroindustry because of several factors explained above. Also there are two

important reasons for developing peanut plantation in Indonesia which are:

1. Demand for the consumption of peanuts in Indonesia is greater than the supply (deficit). The high price of peanuts is caused by an increase in demand that has not been offset by domestic production. But at the time of the harvest, prices at the farmer's level are low. This is because the agricultural commodities of peanuts are easily damaged, and farmers have difficulty marketing their crops. So it is necessary to create an SME-based processing company that involves farmers in peanut producing areas, which aims to add value to peanuts so that the prices are stable and increase farmers' income.

2. Peanut production in Indonesia can be increased by increasing land area and increasing its productivity 2.5-3 tons/ha of dried pods, and decent peanuts being made into peanut butter agroindustry if the production is high and consumer interest in consuming peanut butter is also high.

B. Recommendation

The researcher is suggesting advices about the need for efforts to increase the production and productivity of peanuts to make their availability adequate in meeting with the demand for peanut butter agroindustry. These advices are:

1. Peanut farmers should be incorporated in cooperatives so that they can obtain business capital loans from either banks or cooperatives by means of venture capital.
2. Extension of peanut cultivation technology by using high-production varieties to increase peanut production.
3. Expand the harvest area in the peanut production centers and other potential areas.
4. Make a strategy of ownership so that farmers can participate in owning peanut butter processing plants so as to increase farmers' income.
5. Implementing a system of mutually beneficial results between peanut peanuts and agro-industry actors.
6. And there is a need for support from the regional government and the central government to issue policies that regulate the development and development of industries, especially processing agricultural agro-industries, especially peanut agricultural commodities.

REFERENCES

- Astawan, M and Wahyuni, M. (1991). *Teknologi Pengolahan Pangan Nabati Tepat Guna* (The Appropriate Food Processing Technology for Vegetables Food). Akademika Pressindo, Bogor.
- Bhuyan, S. And Olson, E.F (1997). *Potential role of non-agricultural cooperatives in rural development: A report on focus group studies conducted in rural North Dakota*. American Journal of Agricultural Economics 70(5):1-17
- Bibby, A., and Shaw, L (2005). *Making a difference: Cooperative solutions to global poverty*. Manchester: United Kingdom Co-operative College
- Department of Forestry and Estate Crops. (2010a). *Statistik Perkebunan Indonesia 2009–2011. Kelapa Sawit* (Indonesian Plantation Statistic for Palm Oil in 2009–2011). The Ministry of Agriculture. Jakarta.
- Department of Forestry and Estate Crops. (2010b). *Statistik Perkebunan Indonesia 2009–2011. Karet* (Indonesian Plantation Statistic for Rubber in 2009 – 2011) The Ministry of Agriculture. Jakarta.
- Ditjen Tanaman Pangan. (2013). *Prospek Pengembangan Agribisnis Kacang Tanah*. (Prospect of The Development of Peanut Agribusiness). The Ministry of Agriculture. Jakarta
- FAOSTAT. (2014). *Statistical Data of Food Balance Sheet*. www.fao.org (Accessed in 27 February 2019).
- Ginting, E., Yulfianti, R., Utomo, J.S. (2015). *Standar Mutu Kacang Tanah* (Quality Standard of Peanuts) in A. Kasno, A.A Rahmianna, I.M.J. Mejaya, D. Harnowo, S. Purnomo. (Penyunting) *Kacang Tanah: Inovasi Teknologi Dan Pengembangan Produk* (Peanut: Its Technology Innovation and Product Development) pg 394-406. Malang: Balitkabi.
- Griel, A. E., Eisenstat, B., Juturu, V., Hsieh, G., & Kris-Etherton, P. M. (2004). *Improved diet quality with peanut consumption*. Journal of the American College of Nutrition, 23, 660-668.
- <http://kabartuban.com/kacang-tanah-tuban-bertahan-di-pasar-nasional/7556> (Accessed in 17 March 2019)
- <https://tubankab.go.id/entry/harga-kacang-tanah-turun-ini-penyebabnya> (Accessed in 17 March 2019)
- <https://www.cnnindonesia.com/...hidup/survey-masyarakat-indonesia-mulai-sadar..> (Accessed in 14 March 2018)
- Kasno, A., dan Harnowo, D. (2014). *Karakteristik Varietas Unggul Kacang Tanah Dan Adopsinya oleh Petani* (Superior Varieties Characteristic for Peanut and Its Adoption Method for Farmers). Iptek Tanaman Pangan 9(1): 13-23. Puslitbang Tanaman Pangan.
- Leaflet. (2016). *Varietas Unggul Aneka Kacang Dan Umbi* (Superior Varieties in Nuts and Bulbs). Malang: Balitkabi.
- Machfoedz, M. Mochammad. (2015). *Stabilizing and Decentralizing The Growth Through Agro-Industrial Development*. Paper presented at The 2014 International Conference on Agro-industry (ICoA): Competitive and sustainable Agro-Industry for Human Welfare. Agriculture and Agricultural Science Procedia 3 (2015)20-25
- Masurel, E. And Jansen, P. 1998. *The relationship between SME: Cooperative and market concentration evidence from small retailers in the Netherlands*. Journal of Small Business Management, 36 (2):16-25
- Purnomo and Heni Purnamawati. (2007). *Budidaya dan Jenis Tanaman Pangan Unggul* (Superior Varieties of Crops and Its Cultivation). Penebar Swadaya. Jakarta.
- Purnomo, J. dan Harnowo, D. (2015). *Teknologi Produksi Benih Sumber Kacang Tanah* (Production Technology for Source Seed of Peanut Commodity). in A. Kasno, A.A Rahmianna, I.M.J. Mejaya, D. Harnowo, S. Purnomo. (Editor) *Kacang Tanah: Inovasi Teknologi Dan Pengembangan Produk* (Peanut: Its Technology

- Innovation and Product Development) pg. 407-426.
Malang: Balitkabi.
- Puslitbang Tanaman Pangan. (2009). *Deskripsi Varietas Unggul Palawija* (Description of Palawija Superior Qualities) 1918-2009. Puslitbang Tanaman Pangan.
- Reese, G., and Lehrer, S.B. (1999). Food allergens. In M. Frieri, & B. Kettelhut (Eds). *Food Hypersensitivity and adverse reaction: A practical guide for diagnosis and management* (pp.69-97). New York: Marcel Dekker, Inc.
- Research Institute for Peanut and Bulbs Plants (Balitkabi). (2015). *Kacang Tanah: Inovasi Teknologi Dan Pengembangan Produk* (Peanut: Technology Innovation and Its Product Development). Monograph Balitkabi; No.13-2015. Penyunting Astanto Kasno (et al.). Malang: Balitkabi
- Statistic Central Bureau.(2012). *Produksi Tanaman Pangan 2011* (Food Crop Production in 2011). http://www.bps.go.id/tnmn_pgn.php. (Accessed in 10 January 2018).
- Statistic Central Bureau (2014). *Persediaan dan Konsumsi Kacang Tanah di Indonesia* (Peanut Consumption and Supply in Indonesia). Jakarta.
- Statistic Central Bureau. (2018). *Statistik Indonesia 2018* (Indonesia Statistic in 2018). Statistic Central Bureau. Jakarta.
- Statistic Central Bureau of Republic of Indonesia. (2015). *Luas Panen Produktivitas Produksi Tanaman Kacang Tanah Seluruh Provinsi* (Harvesting Areas as Productivity of Peanut Plant Production in all provinces). http://www.bps.go.id/tnmn_pgn.php?eng=0. (Accessed in 12 January 2018).
- Sumarno. (2015). *Status Kacang Tanah di Indonesia* (Status of Peanuts in Indonesia) in A. Kasno, A.A Rahmianna, I.M.J. Mejaya, D. Harnowo, S. Purnomo. (Penyunting) *Kacang Tanah: Inovasi Teknologi Dan Pengembangan Produk* (Peanut: Its Technology Innovation and Product Development) pg 29-38. Malang: Balitkabi.
- US Departement of Agriculture. (2010). *Food availability (per capita) data system: peanut and tree nuts*. <Http://www.ers.usda.gov/Data/FoodConsumption/Spreadsheets/nuts.xls>. (accessed in 12 December 2018).
- Woodrof, J.G. (1983). Peanut Butter, in Woodrof, J.G.(Ed). *Peanuts, Production, Processing, Product*, 3rd edition. AVI. Publ, Comp.,Inc, Westport, Connecticut.

Designing Control Systems for Jig Rotary Table on The Spot Welding Machine by using the PLC

Syahril Ardi
 Politeknik Manufaktur Astra
 Jakarta, Indonesia
 syahril.ardi@polman.astra.ac.id

Ardi Winata
 Politeknik Manufaktur Astra
 Jakarta, Indonesia
 ardiwinata613@gmail.com

Muhammad Hidayat
 Politeknik Manufaktur Astra
 Jakarta, Indonesia
 m.hidayat@polman.astra.ac.id

Suhartinah
 Politeknik Manufaktur Astra
 Jakarta, Indonesia
 suhartinah@polman.astra.ac.id

Abstract—In previous research, we design control systems that can control a servo motor on a spot welding machine. As controller, the PLC can control the rotary movement on the jig table. In this case, we design the control system, input and output cabling systems to and from the PLC. There is a request for changing in the condenser model, accordingly the spot welding machines are designed and made specifically which used to perform three times welding process on new type condenser parts. From the testing and result, we find that the rotary table jig on the spot welding machine can devolve according to the required welding angle i.e. 17°. It can do the welding process to reach the new condenser specifications.

Keywords—design control systems; jig rotary table; servo motor; spot welding machine; Programmable Logic Control.

I. INTRODUCTION

Recently development of technology that is increasingly influencing the car manufacturer to continue innovate to make cars with new models, both city cars, pickup, sedan, and etc. One of the car makers in Indonesia issued a new pickup truck. The pickup will use a new condenser from before. The demand for new models for condenser products is called the AB model. Condenser AB has a different design with other condenser products that have been produced before. The difference lies in the position of the al-bracket which is in the position of the modulator and the tank header which is installed with the welding process, while the other condenser models that have been produced have a side plate al-bracket position performed by the caulking process. The existence of these differences, it requires a new process, namely welding. To meet the specifications of the AB condenser model it requires programming and manufacturing of welding machine mechanisms. The jig for existing caulking is not possible to assemble the al-bracket with the modulator and tank header. To meet the specifications of the new model condenser, a welding machine is needed that can perform three times the welding process to combine, namely:

- Modulator with tank header.
- Al - Bracket with modulator.
- Al - Bracket with tank header.

Based on these problems, and then carried out observations, analysis and design to deal with this. So based on analysis and observation a new spot welding machine is designed with a

design and mechanism that matches the specifications of the new condenser.

II. METHODOLOGY

A. Product Introduction

Condenser is one of the components of a car's air conditioner that serves to dispose of high-temperature heat which results from compression of refrigerant gases from the compressor, so that the refrigerant changes from gas to liquid. Function of condenser is to dispose high-pressure hot temperatures resulted from compressing refrigerant gases from the compressor also it can convert the refrigerant from the gas to liquid. The function of the condenser product can be run with the completeness of the main constituent components, which include fin cooling, main tube, header plate, side plate, tank header, modulator, separator, and tube connector in-out. Figure 1 show of the physical form of the AB model condenser.

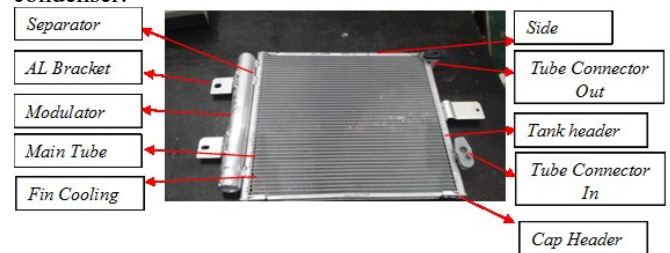

Figure 1. AB model condenser
 Source: PT XY manufacturing

B. Line Part Assembling

Line part assembling is one part of the condenser manufacturing process. Line part assembling is a place for assembling between tank headers and connector in / out, separator, and tank header with modulator. There are several processes that take place in line part assembling. One of them is Assembling Bracket. This process is a process for assembling between brackets and side plates that have been merged into cores. The bracket assembling work process starts from taking part bracket and save it on the jig, after that take the core and save it to the assembling bracket jig, then slide the jig lever to the al-bracket position into the side plate. If the bracket is already on the side plate, the caulking side plate is ready. Then press the double push button then the

caulking process takes place, after the process checks again whether the bracket has been installed on the side plate properly or not, if not then do the same process until the bracket is installed on the side plate. After the bracket is installed then take the core from the jig and move it in the next process. The implication of introduction section is an option only.

C. Problems with the Al-Bracket Assembling Process for Model AB

The difference in bracket position for the condenser AB model it is in the modulator and tank header different from the other condenser models; it makes were impossible for assembling al-bracket process to be done with caulking bracket jigs. Figure 2 show the difference in al-bracket position.

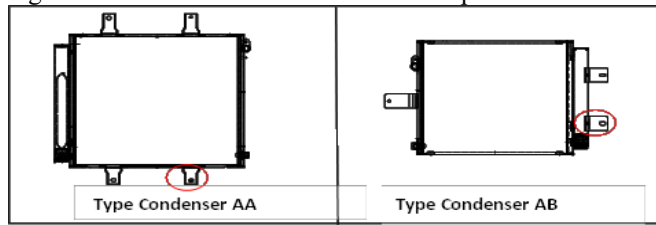

Figure 2. The Difference model condenser AA and condenser AB

Source: PT XY Manufacturing

D. Solution

Based on these problems, a solution was found, namely by making a spot welding machine that can do the welding process automatically and can do rotary movement using a Mitsubishi servo motor HG-KR43B which has integrated encoder and which will be controlled by using PLC to meet the welding angle adjusted to the design of the condenser. Based on the design of the AB model it was found, that it requires 4 welding points for the al-bracket assembling process to the modulator and 2 welding points for the al-bracket assembling process to the tank header.

III. MACHINE DESIGN CONCEPT

A. Required Specifications

To be able to do the welding process automatically and in accordance with the specifications of the condenser model AB, the specifications of spot welding machines are needed which can perform rotary movement on the jig table along with the clamping system for the al-bracket in the jig. The specifications are as follows:

- The welding process must be automatic.
- The servo motor used is the Mitsubishi HG-KR43B servo motor.
- The PLC used as a control device in the system is a Mitsubishi FX3G-60M type PLC.
- The engine mechanism can make rotary movements.
- You can easily switch jigs for 3 welding process steps between al-bracket and tank header and modulator.
- The movement of the welding process can be done manually and automatically using a PLC.
- The welding process movement control system has input devices in the form of push buttons, photoelectric sensors, reed switches, and encoders.

- Photoelectric sensors are used as an anti-jig system when going through the welding process.
- The encoder used is an encoder that has been integrated in the motor so it reduces the wiring carried out on electric machines.

Design mechanical parts are design jigs to store tank header parts, clamping modulator, and al-bracket.

B. Mechanical Design for Spot Welding Machines

It used servo motors in the jig rotary table aims to move the jig rotary so that the angle needed during the welding process can be adjusted so that the specifications needed for the XY condenser model can be fulfilled. Figure 3 show the design of a spot welding machine.

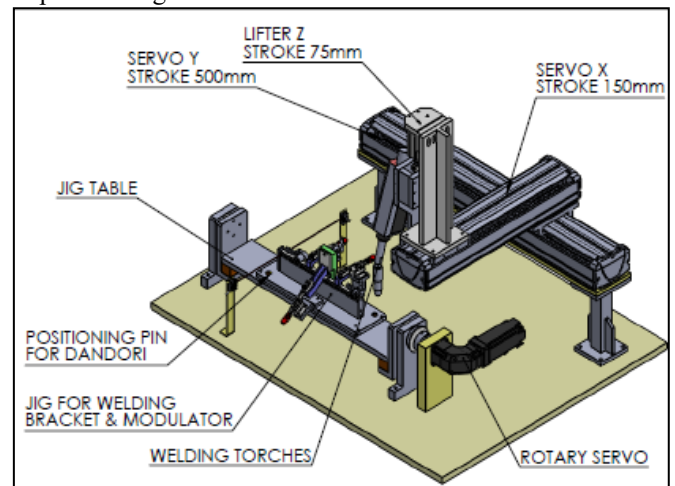

Figure 3. Design spot welding machine

Source: PT XY manufacturing

The mechanism of the movement is, when the servo motor rotates, the rotation of the servo motor will rotate the coupling that is connected to the jig table which then the jig table will rotate following the movement of the servo motor.

C. Control System Design

It has been determined that the rotary table system uses a servo motor that has been integrated with the encoder. Figure 4 show the rotary table control system for spot welding machine.

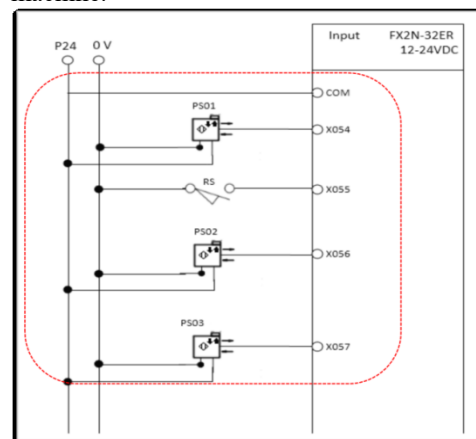

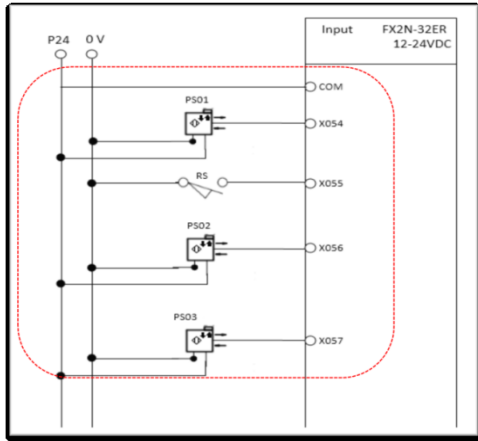

Figure 4. Control system design for spot welding machine
Source: PT XY Manufacturing

In the scheme spot welding machine control system above, it has seen the devices needed by the engine, ranging from input, process, and output devices.

D. Design of Control System

Making control of the rotary table jig includes electrical system assembly, servo motor control, and write program. Electrical system assembly contains the actual components used in input, process, and output devices. The servo motor control explains wiring in the servo motor driver, PLC, and the servo motor.

E. Input Wiring

Photoelectric sensors are used to detect parts and types of jigs that are being used; these sensors are installed on the addresses of the extension input module, Mitsubishi FX2N-32ER. Addressing sensors to PLC uses addresses X054, X056 and X057. Automatic or manual mode setting on the spot welding machine use the selector switch installed at address X034. There are two push buttons that are used to initiate the process that is installed at addresses X036 and X037. The two push buttons are used as a safety system so that the two hands of the operator focus on the two push buttons when carrying out the welding process. Then one button is used to reset the alarm if an undesirable condition occurs and is installed at address X035. Figure 5 show the input wiring on the PLC.

Figure 5. The input wiring PLC for spot welding machine
Source: PT XY manufacturing

F. Output Wiring

After wire input is done, then wire output of the PLC, the output will be connected to the servo motor driver. Figure 6 show the wiring between PLC, driver, and servo motor.

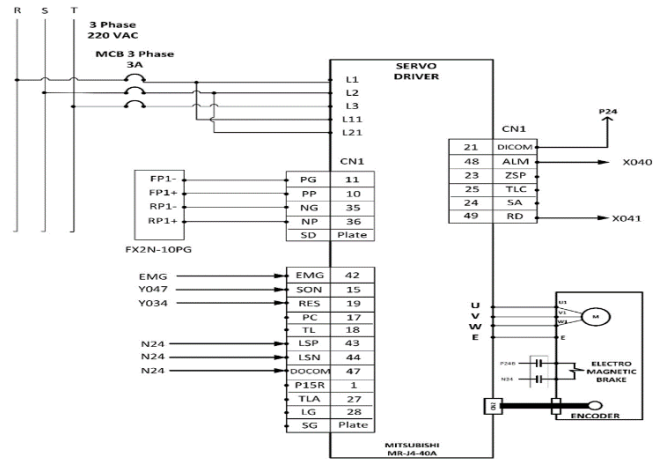
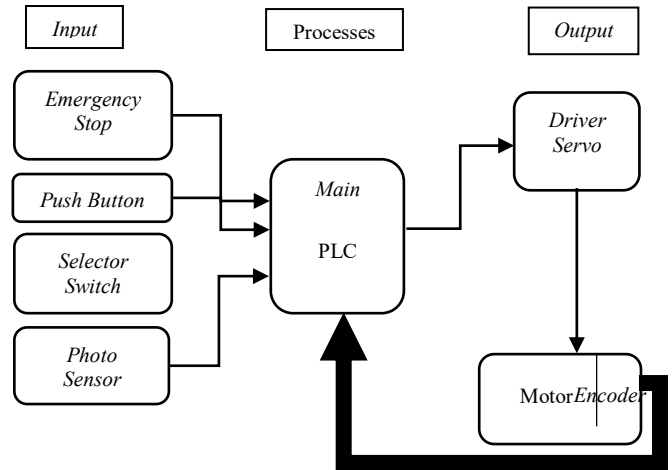

Figure 6. Output wiring PLC to servo motor driver
Source: PT XY manufacturing

G. Communication between PLC, driver and servo motor

The servo amplifier is activated with a voltage of 220 VAC 3 phase and the servo motor gets a source of 220 VAC 3 phase from the output voltage of the driver. The 24 VDC voltage will be routed to the PLC I / O device as common. The voltage source is taken from the main control panel of the spot welding machine. The encoder read using an encoder cable MR-J3ENCBL5M-A1-H.

H. Pulse Servo Motor Calculation

For program settings the servo motor position is set based on the number of pulses given from the FX2N-10PG position module through programming on the FX3G-60M PLC. The number of pulses be regulated so the rotation position, speed and motor movement are corresponding with the parameters. After that, the pulse calculation to move the servo motor to meet the welding angle of the spot welding machine. The encoder read process is done using an encoder cable MR-J3ENCBL5M-A1-H.

So if pulse number move is 17°, it's equal to 198,064,346 pulses. This calculation result use as reference for programming. The data stored in PLC's memory data to determine the movement position of servo motor. After that,

write program to regulate the number of pulses issued which the target position needed can be achieved.

IV. RESULTS AND DISCUSSION

After the design, manufacture, and testing, the next step is to analyze the results obtained. Figure 7 show the design of rotary table system on the spot welding machines.

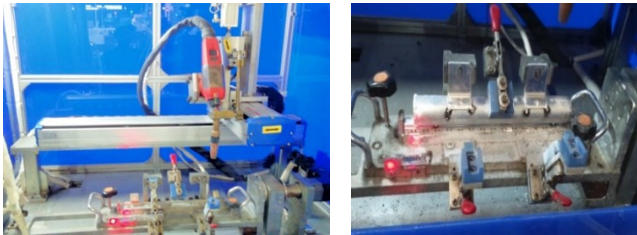

Figure 7. Spot welding machine & rotary table
Source: PT XY manufacturing

Pictures above are the realization of making a spot welding machine using the rotary table system. Specifications of the welding angle needed to make the AB condenser model can be fulfilled and prove that by using a control system with the theoretical foundation used in making this tool can produce tools according to expectations. The results of the pulse calculation required by the servo motor to form a 17° angle can be applied to the servo motor. Figure 8 show the position of the FX3G PLC, FX2N-10PG, and servo motor driver on the spot welding machine panel.

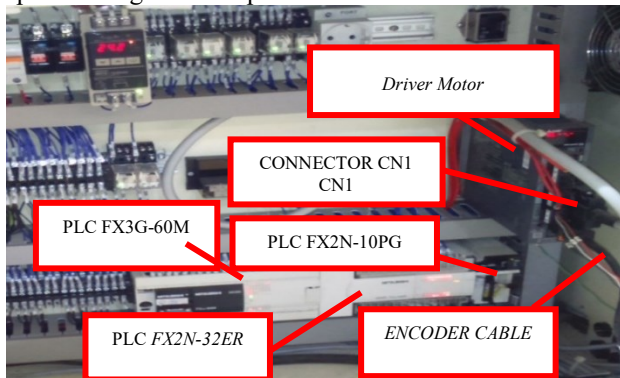

Figure 8. The position of PLC and servo motor driver
Source: PT XY manufacturing

After wiring from the PLC to the motor driver is complete, then wiring from the driver to the servo motor, where the servo motor power has obtained from the output U, V, W contained in the servo motor driver. The reading of the encoder in the servo motor is connected with an encoder cable that is mounted on the CN2 servo motor driver where the pulse reading reaches 4,194,304 pulses / rev. The schematic wiring from the driver to the servo motor can be seen in Figure 9 below.

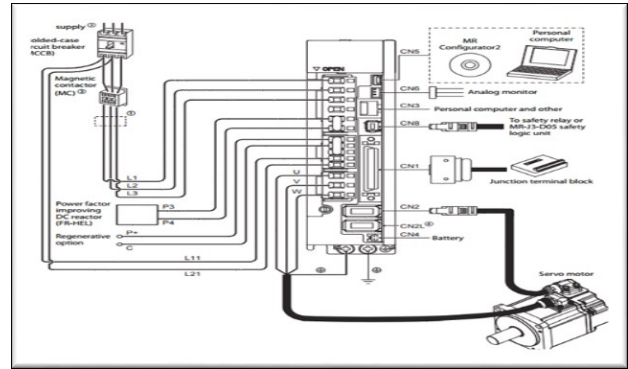

Figure 9. Schematic wiring servo driver and servo motors
Source: PT XY manufacturing

After doing the wiring between PLCs, motor drivers and servo motors then the next step of programming the PLC so that the desired movement of the motor can be arranged. The stages are done on making this includes addressing I / O, pulse counting servo motors required to achieve the desired coordinates and programming the PLC.

Next step is to testing of the machine. There are several parts of testing on the rotary table system in spot welding machines. It aims to ensure that the work function of the system can run as a system engine work is expected. Comprising test of conducted testing input devices to the PLC, the PLC to the output device testing as well as testing the working system of the welding process.

Results of Testing PLC Input and Output Components

Tests performed on the PLC input and output components in the rotary table system are carried out by means of monitor modes in GX-Developer software. Monitor mode is a condition where the PC (personal computer) is connected directly to the machine so that it can be used to monitor the condition of the input, output and contact components inside the PLC.

While testing the output component is by activating the GX-Developer contact ladder diagram in a state of monitor mode, then looking at the indicator changes found in the PLC output module, and seeing the actual occurrence of the actuator. Below are one example of the testing table i / o devices.

Table 1. Results of testing the output of the rotary table system
Source: PT XY manufacturing

No	Address of PLC	Device tested	Function	Parameter	Results	
					O k	N G
1	Y047	servo motor	servo motor On	Y047 coil is active, the PLC indicator lights are on	✓	

2	M024	servo motor	Servo motor to rotate forward	Memory M022 is active, the FP indicator in the active position module. Then motor rotates forward	√	
3	M025	servo motor	Servo motor to rotate reverse	Memory M023 is active, the RP indicator in the active position module. Then motor rotates reverse	√	

Nb:

OK: if the Coil on the monitor mode is activated and the output module indicator is active.

NG: if the coil in the monitor mode is activated and inactive indicator output module.

based on the table of the test results above, proving that by using a programmable logic controller (PLC) control system in making this machine can produce engine performance in accordance with expectations.

REFERENCES

Ardi, S., D Ardyansyah. (2018). *Design Control Systems of Human Machine Interface in the NTVS-2894 Seat Grinder Machine to Increase the Productivity*, IOP Conference Series: Materials Science and Engineering 306 (1), 012112, Manado, Indonesia.

Ardi, S., A Ponco, RA Latief. (2017). *Design of integrated SCADA systems in piston production manufacturing case study on the conveyor, the coolant, the hydraulic, and the alarm systems using PLC*, IEEE Xplore, 187 – 191, Semarang, Indonesia.

Ardi, S., H Abdurrahman. (2017). *Design of pokayoke systems to increase the efficiency of function check oxygen sensor machine using programmable logic controller in manufacturing industry*, IEEE Xplore, 192 – 196, Semarang, Indonesia.

Ardi, S, Al-Rasyid, A. (2016). *Design of Pokayoke Sensor Systems in Drill Oil Hole Machine to Detect the Presence of Drill using Programmable Logic Controller*. *Advanced Science Letters*, Volume 22, Number 7, pp. 1813-1816(4).

Alphonsus, E.R., Abdullah, M.O. (2016). *A review on the applications of programmable logic controllers (PLCs)*.

Renewable and Sustainable Energy Reviews 60, 1185-1205.

Gökhan Gelena, Murat Uzamb. (2014). *The synthesis and PLC implementation of hybrid modular supervisors for real time control of an experimental manufacturing system*. *Journal of Manufacturing Systems* 33, 535–550.

Ardi, S., Cascarine, L.T. (2018). *Design control system of auto air remaining machine based on programmable logic controller in the automotive manufacturing industry*, MATEC Web of Conferences, Bandung, Indonesia.

Ardi, S., Nurdin, M.A.R., Ponco, A. (2018). *Design of pokayoke system on the process of mounting actuator bracket based on programmable logic controller in automotive manufacturing industry*, MATEC Web of Conferences, Bandung, Indonesia.

Ardi, S., Defi, W.Y. (2018). *Control systems modification of loading and unloading in oil filling machine based on programmable logic controller for manufacturing industry*, AIP Conference Proceedings, Malang, Indonesia.

Quantity and Quality Test of DNA Soybean Mutant Lines (*Glycine max* L. Merril)

Anggria Lestami
Agrotechnology, Faculty of
Agriculture
University of Sumatera Utara
Medan, Indonesia
dedek.hanafiah@yahoo.com

Diana Sofia Hanafiah
Agrotechnology, Faculty of
Agriculture
University of Sumatera Utara
Medan, Indonesia

Revandy I. M. Damanik
Agrotechnology, Faculty of
Agriculture
University of Sumatera Utara
Medan, Indonesia

Abstract— Soybean is one of the important commodities in Indonesia, but its production is still low. One factor decreases soybean production due to the attack of the fungus *Athelia rolfsii* Curzi. Mutagenesis is one breeding technique for creating gene variability for resistant of disease in soybean. The study aims to examine the quantity and quality DNA of soybean mutant lines resistant *Athelia rolfsii* Curzi. The study was conducted at Plant Biotechnology Laboratory, Faculty of Agriculture, University of Sumatera Utara, Medan. DNA of 7 soybean mutant lines and a variety of Anjasmoro was isolated using CTAB extraction method, quantity test using a spectrophotometer and quality test using UVITEC Cambridge Fire Reader. The results showed lines that had bright and thick band pattern found in Anjasmoro, M100-25(2/7), M100-A25(3/4), M200-A11(39/7), M300-A8(35/7), while thin and less bright band found in M200-A11(32/3), M200-A12(6/5), M300-A6(33/3). The purity of DNA produced range from 1.84 – 2.00 and the concentration of DNA produced range from 72.9 – 847.3 µg/ml. It is necessary to develop a simpler DNA isolation method to obtain plant DNA with good quantity and quality.

Keywords— soybean, mutant lines, quantity test, quality test, DNA

INTRODUCTION

Soybean (*Glycine max* (L.) Merr) is the third food commodity after rice and corn. As one of the most important legumes species, soybean contains about 40% highly nutritious protein with all essential amino acids compared to others [1]. It is also rich in oligo-elements such as magnesium, phospholipids, vitamins, and minerals [2].

Domestic soybean needs continue to increase in line with the increase in population and the development of the food industry made from soybean raw materials, such as the tempe, tofu industry, soy milk, tempe's chip industry [3]. The average soybean demand in Indonesia per year is around 2.2 million tons. However, to meet these needs soybeans must be imported because domestic production is not able to meet the people's demand [4].

A problem is that productivity is still low due to the attack of stem rot by *Athelia rolfsii*. *Athelia rolfsii* (Curzi) is a potential disease in soybean plants because attacked plants will die and pathogens can last long in the soil in the form of sclerotia. The attack rate of > 5% in the field can be economically detrimental, where the soybean plants that are attacked will be low or even crop failure. The yield loss by *A. rolfsii* (Curzi) can reach 30%, this loss often occurs in lands which are always planted with soybean and other

legumes [5]. This disease is often found in dry land, rain fed and tidal land with disease intensity reaching 55%, if environmental conditions are suitable for disease progression, the loss due to pathogen attacks can reach 100% [6].

The use of resistant varieties is a solution that can be taken to overcome these negative impacts. Besides, the use of resistant varieties is considered economical because it has several advantages, namely cheap, easy, safe, and is one of the effective ways to control plant diseases [7].

The success of plant breeding is determined by the presence of extensive genetic diversity in soybean germplasm populations. Especially varieties are very important in soybean production because to achieve high yields is largely determined by their genetic potential [8]. Mutation induction is an alternative for plant breeders to increase genetic diversity. Mutations are changes that occur randomly in genetic material so that genetic diversity occurs for desirable traits without changing the good nature of existing plants to be assembled into a superior variety.

Further mutation studies have been carried out on Anjasmoro varieties of soybean seeds which were irradiated by gamma rays at a dose of 100 Gy, 200 Gy, and 300 Gy to obtain soybean plants with the desired characters. Sibarani et al [9] showed that the treatment of 300 Gy irradiation tended to decrease the growth and productivity of M1 generation plants. Furthermore, Mustaqim [10] in the M2 generation with a dose of 100 Gy gamma irradiation can increase seed weight per plant. The same results were obtained in the [11] study where doses of 100 Gy gamma irradiation can also increase seed weight per plant in the M3 generation. Further research conducted by [12] shows that in the M4 generation it was found that the effect of gamma-ray irradiation at doses of 100 Gy and 300 Gy based on early maturity and high production characters can increase seed weight per plant. For generation M5, the results of [13] study show that the dose of 200 Gy and 300 Gy gamma-ray irradiation without mushroom inoculation *A. rolfsii* (Curzi) can increase seed weight per plant while 100 Gy gamma irradiation dose with *A. rolfsii* (Curzi) fungus inoculation can increase plant height and accelerate flowering, and at a dose of 300 Gy can increase the number of productive branches and accelerate the age of harvest.

In obtaining superior varieties, the evaluation and characterization process has only been carried out morphologically. However, morphological characterization

strongly influenced by the environment and requires a longer time in the field so a molecular marking approach is needed. Molecular markers are a method of indicating the existence of a nucleotide sequence or more commonly known as a base pair (DNA) that can provide information on a particular sequence of sequences in encoding a trait. DNA molecules in a cell can be extracted or isolated for various purposes such as amplification and analysis of DNA through electrophoresis. Therefore, DNA isolation methods are needed that can produce plant DNA with good quantity and quality.

MATERIALS AND METHODS

This research was carried out at the Molecular Genetics Laboratory of the Faculty of Agriculture, University of Sumatera Utara, Medan in February 2019. The materials used were young leaves of 2 MST aged from 7 seeds of putative mutant soybeans, M100-25 (2/7), M100-A25 (3/4), M200-A11 (32/3), M300-A8 (35/7), M200-A12 (6/5), M200-A11 (39/7), M300-A6 (33/3) and Anjasmoro varieties as elders. Other materials used include liquid nitrogen, tissue, CTAB buffer, TAE buffer, TE buffer, Chloroform Isoamilalkohol (KIAA) with a ratio of 24: 1, NaCl, NaOH, Na-EDTA, HCl, 70% and 100% alcohol, cold isopropanol, β -mercaptoethanol, agarose (Promega V3121).

The tools used in this study include rubber gloves, masks, scissors, digital scales, mortars, pestles, centrifuges (Eppendorf 5415), vortex, freezers, tube racks, PCR tube 0.2 ml and 1.5 ml, micro pipets measuring 1-50 μ l, 100-500 μ l, tweezers, pipette tips, autoclave, waterbath, electric pH meter, hot plate (Biosan) electrophoresis (power supply, well) chamber, magnetic stirrer, glass tools, electrophoresis (Power PAC 3000, Biorad), Gel Doc (UV Cambridge), camera and stationery.

Seed Planting

The young leaves of soybean plants (3-5 weeks old) viz. trifoliolate leaves, taken from plants grown in a greenhouse and put into a plastic sample. The DNA isolation procedure was carried out based on the CTAB Method of Orozco-Castillo et al (1994) which was modified by the addition of Polyvinilpolypirolidone (PVPP) and β -mercaptoethanol [14].

*Quantity Test of Resistant Soybean Mutant DNA *Athelia rolfsii* Curzi*

DNA quantity testing was carried out using the spectrophotometer method using a Nanodrop Spectrophotometer (Thermo Scientific, USA) at a wavelength (λ) 260 and 280 nm using 1 μ l of isolated and purified DNA stock. DNA has high purity if the ratio of absorbance values at wavelengths of 260 nm and 280 nm range from 1.8 - 2.0 [15].

*Quality Test of Resistant Soybean Mutant DNA *Athelia rolfsii* Curzi*

DNA quality testing was done by electrophoresis to see the presence of DNA. The 2% agarose gel was weighed 1.6 g and put into erlenmeyer containing 80 ml of 1x TAE solution, then heated to dissolve using a hot plate and stirred using a magnetic stirrer, after which it was cooled to room temperature. Next, 0.5 μ l EtBr was added and poured into gel electrophoresis molds that had been installed with a

comb (well) until the gel solidified + 40 minutes. The dense gel is transferred into the electrophoresis bath and given a 1x+670 ml TAE solution (until submerged). Each sample that will be electrophoresed was mixed with loading dye with a ratio of 5: 1 (DNA: loading dye). After being mixed, it is injected into the agarose gel well using a micropipette. After all the samples have been injected, the electrophoresis device is connected to a power supply with a 75 volt power supply for 60 minutes. Electrophoresis results were observed with the help of UV lamps in transilluminators and documented using gel documentation.

RESULT AND DISCUSSIONS

DNA isolation is a series of processes to separate DNA from other components. The result of isolation is an important step in ensuring the success of a study because it was used for the next step and must be done well and free of contamination.

DNA isolation is carried out to separate DNA from other materials such as protein, fat, and carbohydrates or in other words the process of obtaining pure nucleic acid. There are three main principles in DNA isolation, destruction (lysis), extraction or separation of DNA from solid materials such as cellulose and protein, and DNA purification [16, 17]. According to [18] the stage of DNA isolation, among others, is by breaking the cell wall to release cell contents, lysis the cell membrane so that DNA dissolves in the buffer, protects DNA from endogenous nucleates, minimizes DNA cutting, and minimizes DNA degradation. To remove DNA from cells, cell membranes must be destroyed.

In this study, the process of DNA isolation of soy mutant strains was carried out by the CTAB method of [19] which was modified from general standard techniques, with the addition of antioxidants Polyvinilpolypirolidone (PVPP) and β -mercaptoethanol, and the use of liquid nitrogen to help destroying tissue and overnight storage of leaf extract that has been crushed before purification.

DNA isolation using the CTAB method can produce 100-500 μ g of DNA per gram of fresh and young plant tissue. The DNA length was at least 50 kb if the DNA did not cut off and there is no nuclease activity. Young and fresh plant tissue will produce large amounts of DNA and contamination from small polysaccharides. Polysaccharides were difficulted to separate from DNA and inhibit the activity of enzymes used and DNA was difficulted to dissolve in the extracting buffer [20].

The high-quality DNA will be obtained in extraction is a basic rule that must be fulfilled in molecular studies especially in DNA analysis. Cetyl Trimethyl Ammonium Bromide (CTAB) is a common method used in extracting plant DNA which contains many polysaccharides and polyphenol compounds [21]. To isolate plant DNA, the cell wall is destroyed by mortar and pestle then followed by an enzyme that will cut the cell wall polymer into a monomer. Cutting the polymer can be done by centrifugation or chemical extraction. Centrifugation will separate components by size while chemical extraction is done by using phenol to separate proteins from DNA [22].

The addition of reducing compounds such as β -mercaptoethanol in the process of DNA isolation can prevent the oxidation of phenolic compounds so that it inhibits free

radical activity produced by oxidation of phenol to nucleic acids [23]. The use of CTAB in the extraction buffer is useful for eliminating polysaccharides. Furthermore, Fang et al [24] and Tel-zur et al [25] stated that the addition of NaCl with concentrations above 1 M can increase the solubility of the polysaccharide so that it is easier to remove. Thus, CTAB buffer was sufficient to meet the requirements for use in extracting DNA from plants that contain high carbohydrates and phenols because they did not damage DNA. CTAB buffers with high salt content can separate polysaccharides from cell walls, while PVPP can reduce browning due to phenol content in young leaves [26, 27]

DNA has been extracted from within the cell needs to be separated from the contaminants of other cell constituent components such as polysaccharides and proteins so that the DNA obtained has high purity. Phenol is often used as denaturing proteins, extraction using phenol causes proteins to lose their solubility and experience precipitation which can then be separated from DNA by centrifugation [28]. The DNA extract obtained is often also contaminated by RNA so that RNA can be separated from the DNA extract using RNase [22]. After the extraction process, the DNA obtained can be concentrated through precipitation. In general, ethanol or isopropanol is used in the precipitation stage. Both of these compounds will precipitate DNA in the aqueous phase so that the clumping DNA forms a fiber structure and forms pellets after centrifugation [29].

Quantity Test

Test the quantity of DNA isolated from the young leaves of the resistant mutant *Athelia rolfsii* Curzi using the spectrophotometer method. DNA purity was measured by calculating the absorbance value of 260 nm divided by the absorbance value of 280 nm. The 260 nm wavelength is the maximum absorption for nucleic acids or the maximum value of DNA can absorb light, while the wavelength of 280 nm is the maximum absorption for protein or the maximum residual value of proteins that can absorb light.

The quantity test was carried out to test the purity level of the isolated DNA. The purity of DNA was determined by the level of protein contamination in the solution. The results of the DNA sample quantity test showed the success of DNA isolation, as evidenced by the purity values ranging from 1.8-2.0 and included in the pure DNA category. According to [30] DNA molecules were said to be pure if the ratio of these two values ranges from 1.8-2.0. Whereas if the ratio $A_{260} / 280$ is smaller than 1.8 indicates the presence of contamination caused by protein or phenol in the isolation results [31]. Besides, DNA was said to be contaminated if the $A_{260} / 280$ ratio is more than 2.0 and this may be contaminated by RNA [32].

The quantity of DNA extracted was analyzed using the spectrophotometer method. The results of DNA extraction can be seen in table 1.

THE DNA CONCENTRATION AND PURITY OF RESISTANT SOYBEAN MUTANT LINES *ATHELIA ROLFSII* CURZI

Sample	Purity ($A_{260}/280$)	Concentration ($\mu\text{g}/\text{mL}$)
Anjasmoro	1.84	300.1
M100-25(2/7)	1.82	94.2
M100-A25(3/4)	1.86	72.9
M200-A11(32/3)	1.94	313.7
M200-A11(39/7)	1.87	253.3
M200-A12(6/5)	2.00	97.9
M300-A6(33/3)	1.97	259.2
M300-A8(35/7)	2.00	847.3

Based on table 1 the results of the calculation of DNA concentration ranged from 72.9-847.3 $\mu\text{g} / \text{mL}$. The small amount of DNA produced was influenced by several factors during extraction and sample conditions. Komalasari [33] states that the concentration of DNA extraction results were influenced by two factors, the extraction speed, and composition of the addition of lysis buffer. The extraction speed factor is the most influential factor because the cell lysis and supernatant precipitation must be sampled, so a few samples experiencing deposition DNA.

Based on the extraction results, the purity level of the sample DNA ranged from 1.84-2.00, where the extraction with a ratio of 1.8-2.00 was high purity DNA and was not contaminated with protein residues. The samples with DNA purity were Anjasmoro (1.84), M100-25 (2/7) (1.82), M100-A25 (3/4) (1.86), M200-A11 (32/3) (1.94), M200-A11 (39/7) (1.87), M200-A12 (6/5) (2.00), M300-A6 (33/3) (1.97), M300-A8 (35/7) (2.00). Another factor that causes impure DNA is the residual content of secondary metabolites in extracted plant organs [34].

Quality Test

The qualitative DNA testing was carried out by electrophoresis technique from DNA isolation results. This is done to determine the purity of a strain or cultivar and to test the entry of certain genetic material (for example in detecting transgenic material) into the population. The electrophoresis method is a technique that can be used to describe the movement of charged molecules in an electric field towards an electrode with an opposite charge or a technique based on the movement of charged molecules in a buffer medium under the influence of an electric field.

Electrophoresis is a technique of separating and purifying fragments of DNA, RNA, or protein. The basic principle of electrophoresis is to separate molecules based on electric charges. DNA electrophoresis is usually used to separate DNA based on differences in size. DNA separation, in this case, is using agarose gel. Agarose is a polysaccharide extracted from seaweed. Agarose pore size is suitable for the separation of nucleic acid polymers composed of hundreds of nucleotides [35].

DNA quality testing was carried out using agarose at a concentration of 2%. The quality test results will show whether or not the DNA band was amplified. The thickness and thinness of the band produced to show the volume and concentration of DNA. Thick bands show high DNA volume and concentration and vice versa. In addition to this, it is also

found a shaded ribbon (smear). This can be caused by DNA mixed with other chemicals such as the presence of proteins, lipids, carbohydrates, RNA and other chemical compounds that are carried accidentally during DNA isolation.

The quality of DNA extracted was analyzed using 2% agarose gel and visualized with UV transilluminator. The results of DNA extraction can be seen in Figure 1.

Based on the results of the quality test from Figure 1, it shows that out of the 8 samples tested all showed the presence of DNA bands. However, some samples show smears, namely M300-A8 (35/7). This causes DNA bands to appear thick due to contamination during isolation and these contaminants can be polysaccharides, proteins, secondary metabolites, and lipids. This is following [36] which states that DNA molds containing compounds such as polysaccharides and phenolic compounds, and too small concentrations of printed DNA often produce dim or unclear amplification DNA bands. Besides, in the study of [37], a less than optimal purification caused some supernatants containing genomic DNA to be wasted so that the resulting DNA concentration was reduced. The difference in results for each sample depends on the amount of DNA concentration extracted. The fewer or no smears on DNA bands show a better quality of DNA.

Electrophoresis test for the quality of resistant soybean

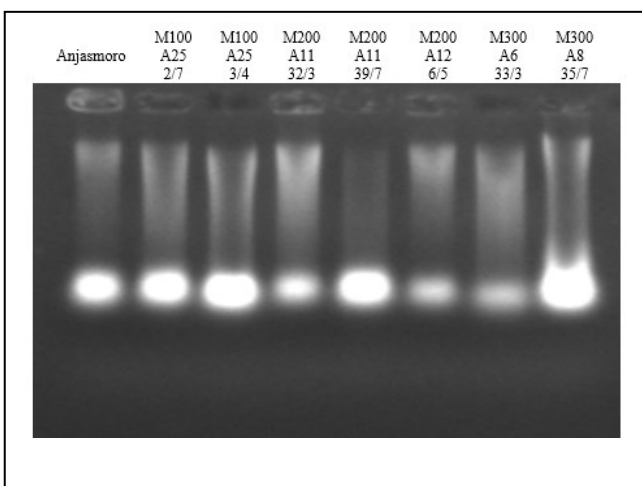

mutant *Athelia rolfsii* Curzi

Prayitno and Nuryandani [38] state that the smear band at the bottom of the genomic DNA band is a molecule with varying weights derived from DNA degradation. Smear indicates that the isolated genomic DNA is no longer intact, possibly fragmented during extraction [39]. The smear DNA was degraded in the isolation process, because of the enzyme endonuclease. The presence of DNA samples left in the gel well at the time of electrophoresis shows the high contamination of polysaccharides which were also extracted [40].

The quality test results are different from the quantity test results, where high DNA concentrations show less bright bands and vice versa. The difference in the results of the quantity can be caused by the techniques at the time of measurement, among others, when performing homogenization before spectrophotometry, some DNA was

attached to Eppendorf and the pipetting process is less precise which causes DNA to break into fragments. This technical error caused the concentration of DNA in the spectrophotometer results to be less than the results of DNA quality testing. The difference in DNA purity was caused by the remaining material, such as the presence of loading dye or ethidium bromide found in the pores of the Agarose gel, so that there is a thin smear between the DNA bands.

CONCLUSION

Soybean mutant lines showing bright and thick DNA banding patterns were found in Anjasmoro, M100-25(2/7), M100-A25(3/4), M200-A11(39/7), M300-A8(35/7), while thin and less bright band found in M200-A11(32/3), M200-A12(6/5), M300-A6(33/3). The purity of DNA obtained ranged from 1.84 - 2.00 and the concentration of DNA produced range from 72.9 - 847.3 µg/ml. It is necessary to develop a simpler DNA isolation method to obtain plant DNA with good quantity and quality.

REFERENCES

- Raghuvanshi, R.S. & Bisht, K. (2010). Uses of soybean: Products and preparation. In: Singh G (Ed.), *The Soybean: Botany, production and uses*. (pp. 345-374). USA. CAB International.
- Ali, N. (2010). Soybean processing and utilization, In Singh G (Ed.), *The Soybean: Botany, production and uses*. (pp. 345-374). USA. CAB International.
- Murtiati, S., Anwar, H. & Sutrisno, I. (2010). *Introduksi Varietas Kedelai Mendukung Program Peningkatan Produksi Menuju Swasembada Kedelai di Jawa Tengah*. Paper presented at Seminar Hasil Penelitian Tanaman Aneka Kacang dan Umbi 243-247.
- Riniarsi, D. (2016). *Outlook komoditas pertanian tanaman pangan kedelai*. Pusat Data dan Sistem Informasi Pertanian Kementerian Pertanian. Jakarta.
- Wahyuningsih, I. (2005). Aplikasi rhizobakteri antagonis untuk mengendalikan penyakit *Sclerotium rolfsii* Sacc pada fase vegetatif tanaman kedelai (*Glycine max* L. Merrill) secara in vivo. (Skripsi). Universitas Muhammadiyah Malang.
- Sumartini. (2011). Penyakit tular tanah (*Sclerotium rolfsii* dan *Rhizoctonia solani*) pada tanaman kacang-kacangan dan umbi-umbian serta cara pengendaliannya. *Jurnal Litbang Pertanian*, 31 (1).
- Muhidin. (2004). Uji antagonis rhizobacteria terhadap patogen *Sclerotium rolfsii* Sacc dari Tanaman Kedelai. *J. Tropika*, 12(1), 93-103.
- Marlia, A., Hidayat, T. & Husna, N. (2012). Pengaruh varietas dan jarak tanaman terhadap pertumbuhan dan hasil tanaman kedelai (*Glycine max* L.). *Jurnal Agrista*, 16(1), 22-28.
- Sibarani, I. B., Lahay, R.R., & Hanafiah, D.S. (2014). Respon morfologi tanaman kedelai (*Glycine max* (L.) Merrill) varietas Anjasmoro terhadap beberapa iradiasi sinar gamma. *Jurnal Agroekoteknologi*, 3(2), 515-526.
- Mustaqim, I. (2015). Keragaman morfologi dan genotif tanaman kedelai (*Glycine max* L. Merrill) hasil iradiasi sinar gamma pada genererasi M2. (Skripsi). Universitas Sumatera Utara.
- Sihombing, Y.B.L., Hanafiah, D.S., & Husni, Y. (2016). Seleksi individu M3 berdasarkan karakter umur genjah dan produksi tinggi pada tanaman kedelai (*Glycine max* L. Merrill). *Jurnal Agroekoteknologi*, 4(4), 2272-2283.
- Bangun, K. (2016). Seleksi individu terpilih dari barisan terbaik pada tanaman kedelai (*Glycine max* L. Merrill) M4 iradiasi sinar gamma berdasarkan karakter umur

- genjah dan produksi tinggi. (Skripsi). Universitas Sumatera Utara.
- Rahmah, M. (2017). Seleksi individu terpilih pada tanaman kedelai (*Glycine max* L. Merrill) generasi M5 berdasarkan karakter produksi tinggi dan toleran penyakit busuk pangkal batang *Athelia rolfsii* (Curzi). (Skripsi). Universitas Sumatera Utara.
- Toruan, Mathius, N., & Hutabarat, T. (1997). Pemanfaatan teknik penanda molekuler dalam usaha meningkatkan produktivitas tanaman perkebunan. *Warta Biotek Perkebunan*. 2(1), 2-9.
- Sambrook, J., Fritsch, E.F., & Maniatis. (1989). Molecular cloning a laboratory manual. Cold Spring Harbour Laboratory. CSH. New York. *Evolution*, 51:1764-1772.
- Corkill, G. & Rapley, R. (2008). The manipulation of nucleic acids: *Basic tools and techniques in molecular biomethods handbook* (2nd). USA. Walker, J.M., Rapley, & R. Humana Press.
- Dolphin. W. D. (2008). *Biological investigations*. New York: MC Graw-Hill.
- Sumner. T. (2003). *Chromosome organization and function*. Oxford: Blackwell Publishing.
- Orozco-Castillo, C., Chalmers, K.J., Waugh, R., & Powell, W. (1994). Detection of genetic diversity and selective gene introgression in coffee using RAPD markers. *Journal of Applied Genetics*, 87: 934-940.
- Ausubel, F. M. (1998). *Current protocols molecular biology*. USA: John Willey & Sons.
- Jose, J. & Usha, R. (2000). Extraction of perminiviral DNA from a highly mucilaginous plant (*Abelmoschus esculentus*). *Plant Mol. Biol. Rep.* 18: 349-355.
- Clark. D.P. & Pazdernik. N.J. (2009). *Biotechnology applying the genetic revolution*. New York: Academic Press.
- Wilkins, T.A. & Smart, L.B. (1996). Isolation of RNA from plant tissue. In : Krieg, P.A. (Ed.), *A Laboratory Guide to RNA. Isolation, analysis and synthesis*. New York: Wiley-Liss.
- Fang, G.S., Hammer & Grumet, R. (1992). A quick and inexpensive method for removing polysaccharides from plant genomic DNA. *Biotechniques*, 13(1), 52-57.
- Tel-zur, N. S., Abbo, D., Myslabodski & Y. Mizrahi. (1999). Modified CTAB procedure for DNA isolation from epiphytic cacti of genera *hylocereus* and *selenicereus* (Cactaceae). *Plant Mol Biol Repr*, 17: 249-254.
- Porebski, S., Bailey, G.L & Baum, B.R. (1997). Modification of a CTAB DNA extraction protocol for plants containing high polysaccharide and polyphenol components. *Plant Mol Biol Repr*, 15(1), 8-15.
- Surzycki, S. (2000). *Basic techniques in molecular biology*. New York: Springer-Verlag.
- Karp. G. (2008). *Cell and molecular biology*. New York: John Willey & Sons.
- Switzer. (1999). *Experimental biochemistry*. Oxford: Blackwell Scientific Pub.
- Tenriulo, A., Tonnek, S., Tampangallo, B.R., Widodo, A.F., & Parenrengi, A. (2010). *Analisis Ekspresi Gen Antivirus PmAV pada Udang windu (Penaeus monodon) yang ditantang dengan WSSV*. Prosiding Forum Inovasi Teknologi Akuakultur. 541. 6 hlm.
- Devereux, R. & Wilkinson, S.S. (2004). *Amplification of Ribosomal RNA Sequences*. Netherlands: Kluwer Academic Publisher.
- Khosravinia, H., Murthy, H.N.N., Parasad, D.T., & Piraniy, N. (2007). Optimizing factors influencing DNA extraction from fresh whole avian blood. *African Journal of Biotechnology*, 6(4), 481-486.
- Komalasari, K. (2009). Pengaruh perbandingan volume darah dan lisis buffer serta kecepatan sentrifugasi terhadap kualitas produk DNA pada sapi Friesian Holstein (FH). (Skripsi). Institut Pertanian Bogor.
- Fatchiyah. (2011). *Pelatihan analisis fingerprinting DNA tanaman dengan metode RAPD*. Modul Laboratorium Sentral Ilmu Hayati. Universitas Brawijaya.
- Firdausi, I. & Kusumawati, L. (2008). *Teknik analisis biologi molekuler dan seluler : Analisis kekerabatan*

Performance of Three Varieties on True Shallot Seed (TSS) Seedling in Sand Soil Area

Joko Pramono

Assessment Institute for
Agricultural Technology
Yogyakarta

Jl. Stadion Maguwoharjo No. 22,
Wedomartani, Ngemplak, Sleman,
Yogyakarta, Indonesia

Maspramono64@yahoo.com

Sutardi

Assessment Institute for
Agricultural Technology
Yogyakarta

Jl. Stadion Maguwoharjo No. 22,
Wedomartani, Ngemplak, Sleman,
Yogyakarta, Indonesia

s.pd_sutardi@yahoo.co.id

Bambang Sutaryo

Assessment Institute for
Agricultural Technology
Yogyakarta

Jl. Stadion Maguwoharjo No. 22,
Wedomartani, Ngemplak, Sleman,
Yogyakarta, Indonesia

b.sutaryo@yahoo.com

Abstract - *The quality or quality of seeds is the beginning of the success of planting shallots from seeds (TSS). The study aimed to determine the growth of shallot seed from the seeds of the direct seed sowing system (Tabela) in sand soil. The study uses of on farm research approach with farmers as cooperators. The research was conducted in two different locations of beach sand, namely the Manunggal Farmer Group, Srigading, Sanden, Bantul and Sidodadi Farmer Group of Trisik, Banaran, Galur, Kulon Progo during April to July 2018. The study was arranged in a Randomized Complete Block Design (RCBD) with the treatment of three shallot varieties namely Bima, Trisula and Lokananta. The study was repeated 4 times, on a land of 0.5 ha per variety. The results of the study showed that growth power, root length, seedling population were not significantly different, whereas plant height, leaf number and adaptability were significantly different for each variety. Lokananta variety were performance better than Trisula and Bima indicated by some characters such as oplant height, total number of leaf, seedling weight and adaptation ability. Plant height of Lokananta was higher of 4.5-5.4 cm than Trisula and Bima in two locations. Leaf total number of Lokananta was also higher about 0.4 than Trisula and Bima. Seedling weight of Lokananta showed higher 0.29 g than that of trisula and Bima, meanwhile adaptation ability of Lokananta was 6.43% higher tan Trisula and Bima. Seedling of TSS actually was adapted to sand soil area.*

Keywords : TSS, direct seeding, sand soil area

Introduction

Indonesian shallots are unable to form seeds because these plants come from four seasons or have to pass two seasons or bianual. But shallots varieties have undergone adaptations so they are able to form seeds such as Bima VUB and Trisula. The use of seeds will produces healthy plants (virus free) (Dirjen Hortikultura, 2005), furthermore will produces tubers with better quality (large and round) (Permadi, 1993; Putrasamedja, 1995). Indonesian farmer, in fact, has become the technical aspects, social, economic, and cultural cultivation of shallot seeds derived from tubers, so that in future required the introduction of shallot from seeds (TSS).

The disadvantage of using seeds from tubers comes from the harvest (consumption bulbs) of past plants

as planting material it has proven economically expensive and other risks are quite high. Seed costs are around 40% of total production costs (Suherman and Basuki 1990) and even up to 50% of the total cost of the farming. Moreover, seeds from tuber that planted for a long time and continuously, there was a declining in the yields of shallots both quantitative and qualitative. Walkey *et al.*, (1987) concludes that the cultivation of shallot from tuber have impact on shallot production decline between 25-50% and the amount of cloves, resulting in a weight reduction of the tuber up to 45%. Santoso (2008) report that the quality of seed from tubers have significant impact on the declining in yields. So the solution according to Basuki (2009) is the use of TSS as a planting material capable of increasing yields by up to two times compared to the use of tuber consumption and better tuber quality (Ridwan *et al.* 1998, Permadi 1993, Sumanaratne *et al.* 2005). Break the link between seeds from tuber with consumption very necessary because the price of shallots is expensive, thus seed from tuber also expensive. In contrary, there is no price connection if we use seed. Economically, the use of TSS can reduce costs up to 50 - 77% (Sاتمoko Budi Santoso, 2018; Anonimus 2018).

Botanical seeds of shallots or true shallots seed (TSS) are an alternative technology for shallot cultivation that is potentially used in order to provide quality shallot seeds continuous every year. TSS is obtained from red shallot flower tubers which has been matured, while pollination can be helped by hand or insect pollinator. The production of shallot bulbs using TSS has advantages compared to the use of tuber seeds, that is the required volume of TSS is lower which is around 3-4 kg ha⁻¹ so the cost of seed supply is more efficient, TSS transport and storage is easier and cheaper, produces plants that are healthier because they are pathogenic free and produces tubers with better quality because the tubers produced will be larger in size and more round compared to shallot from tuber (Sumarni *et al.* , 2005). Production of shallot bulbs using TSS seeds can be reached in three ways, that is planting TSS directly in the field, seeding TSS seeds first so that seeds (seedling) are reproduced, and planting mini tuber (mini tuber/shallots set) which is a small tuber (2-3 g / tuber) originating from TSS seeds (Sumarni *et al.* , 2012).

The shallot variety from seeds starting in 2004 has been introduced to shallot varieties TUK TUK ,

now developing VUB and Bima Brebes, Sanren, Lokananta, TSS Agrihorti 1, TSS Agrihorti 2 (Anonymous, 2018) to be an alternative varieties rotation in a year. Each variety has its own weaknesses and strengths so it is suggested that rotation of varieties can be used to break the cycle of major pests and diseases. The involvement of producers for the supply of shallots seed is needed. The denser plant density is 400 plants per m² which can produce the largest number of tubers (2.5-5 g / tuber) at most (Rosliani *et al.* 2002). The success of the shallot production use TSS must be germinated first so that the seeds that produces tuber will be stronger and more robust and the number of seeds is more efficient (Sumarni, *et al.*, 2010). Basuki (2009) recommends that the use of TSS is feasible economically and more efficient up to double compared to the use of tuber seeds, healthier, and the volume of seeds that needed are lower.

Seeding on the beginning of the shallot cultivation is needed like rice cultivation. Dry rice seedling system (dapog) is very good, so that the shallots from seeds can also be done with models such as dapog. Some nursery models in supporting shallots from the seeds of the box system, tabela, polybags and others that related to the level of difficulty and success even the planting area.

Based on the above To improve the quality and quantity as material, system research is needed seedling in situ. This is related to several constraints of germination caused by seed structures such as ku lit, endosperm, and seed embryos on 3 shallot varieties, namely the Lokananta, Bima and Trisula varieties. The research aims to run to the ri system red shallot seedlings from which seeds can improve sprouted seeds (power and speed of germination), vigor and adaptability after the transplanting and more economical can be applied by a wide-scale farmers by farmers.

Materials and Methods

Location And Time

Manunggal Farmers Group, Srigading Village, Sanden District, Bantul Regency and Farmers Group Sido Dadi, Sidorejo, Banaran Galur District, Kulon Progo Regency. Regency. The location is situated in South of the Indonesian Ocean or the South Sea of Yogyakarta. Srigading Village lies in Longitude Coordinate 110.2824 and Latitude Coordinate: -7.984688, height ± 10-20 m above sea level. Banaran Village in latitude 7 ° 57 '45 "S and longitude 110 ° 12' 53" E. at an elevation of 10-20 m above sea level, 20 km from Kulon Progo city. Analysis of growth media physical and chemical properties was conducted at the IAAT Yogyakarta of Crop Science and Production, Soil Science Laboratory, IAAT of Agriculture. Seedling seeds in May - June 2018 for 35 days after seeding (hss). Experimental site the study was conducted at the TSS in the coastal sand field of the

Seedling Pre-Treatment And Germination

TSS seeds onion before sowing are soaked in warm water (50 oC) and / or Previcur N fungicide solution (2 cc / l) for 3 hours, then drained overnight and then sown in sand fields.

Seedling Pre-Treatment And Media Preparation

The seedling media is sterilized by burning with rice husk, with a thickness of 5 cm. After finishing the fire, then the planting media is stirred stirring the burning husk with the top soil. Then the land is moistened 3-4 times until the valley for 3 days, then fertilized with NPK (16: 16: 6) dose of 50 kg / ha. The land is made of seedling grooves with a distance of 25 cm as deep as 5 cm, the seeds are sprinkled on top with a dose of 5 g / m². The seeds in the planting groove are covered with charcoal husk, then doused with water to the valley. Then covered with straw mulch with a thickness of 2-3 cm, after 5 days of opening, the seeds have begun to grow.

Determination Of Growth Media Physical And

Chemical Properties

Growth media pH was measured from a soil-water suspension (1:1, v/v) by a pH meter (model: Hannah HI 110). Cation exchange capacity (CEC) was determined by the ammonium acetate saturation method. Total nitrogen (N) content was determined by Kjeldahl method and measured on a distillation unit (model: BuchiK-350). Available phosphorus (P) was determined by the Bray II method and measured on an inductively coupled plasma - optical emission spectrophotometer. Exchangeable potassium (K⁺) was measured by flame photometer after extraction with 1 N ammonium acetate pH 7.0.

Experimental Design

The experiment was arranged in a complete randomized block design (RCBD) with three treatments (TSS Varieties) each replicating d four times. The three treatments are as follows; Bima varieties, Trisula and Lokananta varieties are each treated at two locations. The plot area is 1 x 2 m², each treatment with seedlings per replicate randomly located in sand fields (Fig. 1). This gives a total of 250 m² of each location. Experiments were carried out in open sand land without shade to minimize water loss. Seeds are watered twice a day, in the morning and evening with sprinklers. Weed is removed manually by hand every time it occurs. There is no fertilizer supplied to the seeds.

Growth Parameters

The experiment was monitored for forty days (8) weeks after planting (WAT) and growth parameters measured are: growth power, plant height, number of leaves, weight of total seedlings (roots + shoots) fresh weight and seedling population and adaptability. Measurements were taken once at the age of 40 when planting moved at the end of the study. Growth / vigor is

measured after 7 days, observed the percentage of the number of live seeds from 100 seeds. Plant height (cm) is measured using a ruler meter from the ground to the terminal end. The number of leaves was measured quantitatively at 40 days after seedling. The destructive method was used to determine the fresh weight (g) measured at 40 days after the seedlings of 5 seeds were used per replica. The average is then taken to represent the test. Adaptability was observed after transplanting in 25 clusters, calculated that the living plants were recorded, then qualitatively the percentage of life.

Data analysis

The data collected was subjected to analysis of variance (ANOVA) using the STATISTIX SAS -1 program. Where a significant F-test was observed and means comparison test were carried out using Least Significant Difference (BNJ) at $p \leq 0.05$ to separate treatment means

Results And Discussion
Location condition

This study conduct in two different locations and farmers as cooperators: First in the coastal sand area of Trisik Farmers Group Sido Dadi, Tegal Rejo Hamlet, Banaran Village, Galur District Kulon Progo Regency. Second, sand area of Samas beach farmer group Manunggal, Srigading, Sanden, Bantul. Sand area used for seeding TSS is a former Red Chili field that have gone through the bera process. The diseases that often attack during the process of seedling growth are *Altenanteria porri* and *Colletotrichum* sp as well as weeds (Teki and wide leaves) but can be controlled. In general, the intensity of the disease is low because the nursery is carried out in the dry season, but based on insect catches with light traps, caught insects, especially lice and catching are quite a lot. Irrigation is carried out by irrigation of fog and sprinklers so that leaching of the leaves (spores) and adjusting the moisture can be controlled or pressed. The development of shallots according to Udiarto *et al.* (2005) that conditions supports the growth and development of *A. porri* fungi and *Colletotrichum* fungus is aroused by microclimate conditions such as high air humidity. Fungi *A. porri* can grow at a temperature of ± 25 o C. Indrasari (2002) states that The fungus *Colletotrichum* sp can develop and attack plants on humidity $\pm 78.5-82.95\%$. The air temperature and humidity that quite good during nursery does not support the development of the fungus. The characteristic attack of *A. porri* is the presence of ring-like patches with the middle part purple and the reddish edge. The tips of the leaves dry out so that the leaves are broken and the surface of the spot is finally blackish brown. The attack of the *Colletotrichum* fungus is marked by the appearance of colored patches white on the leaves, then formed into an indentation, hollow and broken. If the attack continues, the curve turns brown, dark brown, and finally blackish (Udiarto *et al.*, 2005). Both of these diseases can be

controlled by washing the leaves in the morning and spraying them regularly.

Agronomy Performance

The results of seedling recapitulation in two locations (Table 2) growth power, root length, seedling population were not significantly different, whereas plant height, leaf number and adaptability were significantly different influenced by TSS varieties. Seed weight produced for plant material was significantly different between varieties (Table 2).

Table 2. Scope Recapitulation of Agronomic Variety in Samas Market District, Bantul Regency and Trisik Sand Land, Kulon Progo Regency, DS 2018

Character	Sido Dadi farmer group, Banaran, Galur, Kulon Progo		Manunggal Farmer Group, Srigading, Sanden, Bantul	
	Agronomic data	kk (%)	Agronomic data	kk (%)
Growing Power (%)	tn	3.76	tn	3.78
Plant Height (cm)	**	7.58	**	7.08
Number of leaves	**	6.62	**	6.58
Seedling weight (g / seed)	*	11.82	*	10.82
Root length (cm)	tn	11.17	tn	10.07
Seedling population (25 cm ²)	tn	20.64	tn	12.04
Adaptability (%)	**	2.18	**	2.28

Remarks: * = real at P <0.05, ** = significantly P <0.01, ns = not significantly different

The TSS seeding system is applied by farmers in both locations with a system of sowing seeds directly into the field in-situ in a specific location . The results of seeding in both locations were quite good, it was evident that the age of 30 hss seedlings were ready for transplanting with the characteristics of healthy seeds, strong, high and optimal number of leaves. The direct seedling system of agronomic performance in both locations and the three varieties Bima, Trisula and Lokananta is quite healthy. It is proven that the root system and root length are quite good.

Seed Quality

TSS germination power in the laboratory showed a value below the standard, which was 80% and the vigor index was 80 %. This shows that the seeds used meet the standards of the National Seed Development Directorate (2007) which states that the minimum germination power of shallot seeds is 75%. The growth power of TSS in the field is very low, quite good for TSS direct planting for TSS seeded is 70,58%. This data gives an indication of the

optimum growing environment so that the power to grow in the field is better than the vigor index in the laboratory. The optimum growing environments is due to the optimum planting media. Cut chicken waste husk media burned for 2 days at a thickness of 5 cm, then mixed with sand or rice husk burned mixed with organic fertilizer (1: 4) is optimal for TSS shallot seedlings. Rosliani *et al.* (2014) reported that the optimum planting medium for the growth of shallots from TSS is compost + husk charcoal.

Table 3. Sprout Power 3 red shallot varieties from seeds in both location

Variety	Sprout Power (%)	
	Sido Dadi farmer group, Banaran, Galur, Kulon Progo	Manunggal Farmer Group, Srigading, Sanden, Bantul
Bima	84.00 ^a	85.00 ^a
Trisula	83.73 ^a	85.73 ^a
Lokananta	87.43 ^a	88.43 ^a
CV	3.76	3.78

Description: Superscript numbers followed by different letters in the same column show results that are = 5%. (*) is significantly different at the level of 5%; (tn) α significantly different based on BNJ on not significantly different

Seed Growth

Plant Height

The results of the observations indicate that the two locations of high yielding plants the highest were Lokananta varieties (23.14 cm and 21.14 cm) compared to Bima and Trisula varieties not significantly different. The difference in plant height > 4 cm is enough to deny higher and interest that the Lokananta variety is more striking than the Bima and Trisula varieties. The growth of location 1 plant height in the "Sido Dadi" farmer group was higher than the second location in the "Manunggal" farmer group. Differences in plant growth due to differences in seedling planting media. The seedling media of broiler chicken husk waste is better than rice fuel husk, even though it is mixed with organic fertilizer. Weed growth in fuel husk media and organic fertilizer is more than that of broiler waste husk media so that it greatly influences competition in nutrition, affecting plant height. High variance analysis results are shown in Table 4.

Table 4 . Plant height (cm) 3 red shallot varieties from seeds in both locations

Variety	Plant Height (cm)	
	Sido Dadi farmer group, Banaran, Galur, Kulon Progo	Manunggal Farmer Group, Srigading, Sanden, Bantul
Bima	18.69 ^b	17.69 ^b
Trisula	17.71 ^b	16.71 ^b
Lokananta	23.14 ^a	21.14 ^a
CV	7.08	7.58

Description: Superscript numbers followed by different letters in the same column show results that are = 5%. (*) is significantly different at the level of 5%; (tn) α significantly different based on BNJ on not significantly different

Sumarni *et al.* (2010) stated that plants from TSS seedlings were stronger and more robust than TSS direct planting to produce better plants. Reserve the stored food seeds and the difference in time needed to achieve maximum height is related to differences in tuber and seed structure. Brewster (2008) states that red shallot tubers have formed pseudo stems and apical shoots containing leaf primordia. While in plants from primordial TSS leaves formed along with plant growth.

Number Of Leaves

The results of observations of the number of leaves showed that TSS produced the highest number of leaves of 3-4 strands in the Lokananta variety, while the Bima and Trisula 2-3 varieties were significantly different. Plant material in the form of seedlings of TSS yields leaves > 3 to 4 strands per seed (Table 5). The difference in the number of leaves is due to the size and size of the seeds of the Lokananta variety and the weight of 1000 grains higher than the Bima and Trisula varieties. In general, TSS requires a longer time in leaf formation because unformed leaf primordia. Leaf formation on TSS requires prior initiation that occurs in the apical meristem.

Table 5. Number of leaves of 3 shallots varieties originating from seeds in both locations

Variety	Number of leaves	
	Sido Dadi farmer group, Banaran, Galur, Kulon Progo	Manunggal Farmer Group, Srigading, Sanden, Bantul
Bima	3.04 ^b	3.04 ^b
Trisula	2.96 ^b	2.96 ^b
Lokananta	3.36 ^a	3.36 ^a
CV (%)	6.58	6.62

Description: Superscript numbers followed by different letters in the same column show results that are = 5%. (*) is significantly different at the level of 5%; (tn) α significantly different based on BNJ on not significantly different

Seedling Production

Seed And Plant Weight

Planting materials from seeds produce significantly different weight per clump of varieties. Seedling weight per plant of the Lokananta and Bima varieties is higher than the Trisula variety. The weight of wet seeds per plant that produced by the Lokananta and Bima varieties are not significantly different. Seed weight as planting material the Lokananta variety of 1.5 g / seedlings in both locations is the same as the seed, while the Bima and Trisula varieties are equal 1.21 and 1.4 g / seeds of the same guard location. TSS seedlings produce wet seed weight not affected by differences in location (Table 6).

Table 6. Seed weight per plant 3 seed varieties originating from seeds in both locations

Variety	Seed weight (g)	
	Sido Dadi farmer group, Banaran, Galur, Kulon Progo	Manunggal Farmer Group, Srigading, Sanden, Bantul
Bima	1.41 ^{ab}	1.41 ^{ab}
Trisula	1.21 ^b	1.21 ^b
Lokananta	1.50 ^a	1.50 ^a
CV	10.82	11.82

Description: Superscript numbers followed by different letters in the same column show results that are = 5%. (*) is significantly different at the level of 5%; (tn) α significantly different based on BNJ on not significantly different

The plant origin of TSS when sown with a spacing of 10 cm between kerf with a density of 1.6 g / m² (± 480 grains / m²) with germination power of 75% will produce 3,600,000 plants per hectare. Based on this, TSS seedlings have the potential to produce shallot bulbs of 17.56 tons ha⁻¹ and 16.02 tons ha⁻¹ respectively. Thus, the production of TSS is higher than tuber (Shavira Ayu Adinda, 2016).

Root Length

The root length reflects that the seedling media will be optimal if the penetration power of the root entry is not inhibited, so that nutrient absorption is better because root stamps are wider and longer. Based on the results of the observation, the root lengths of the three varieties were not significantly different, although the Lokananta variety tended to be longer ± 1 cm longer than Bima and Trisula (Table 7).

Table 7. Root length of 3 shallot varieties originating from seeds in both locations

Variety	Root length (cm)	
	Sido Dadi farmer group, Banaran, Galur, Kulon Progo	Manunggal Farmer Group, Srigading, Sanden, Bantul
Bima	9.29	9.29
Trisula	10.51	10.51
Lokananta	10.31	10.31
CV (%)	10.07	11.17

Description: Superscript numbers followed by different letters in the same column show results that are = 5%. (*) is significantly different at the level of 5%; (tn) α significantly different based on BNJ on not significantly different

Density (Population)

Based on the results of previous studies that the age of seedling is ready to be transplanted (transplanting) age 6-8 weeks after seedling. The success of the seedlings is determined by bib it surviving until the age of 30-35 hst, so that the seedling population becomes the main nursery. The more densely populated the population, the better the quality of seeds compared to rather rare. Population density is not significantly different between varieties, but Lokananta tends to be higher than Bima and Trisula, both

population locations are the same. If in one hakter 800,000 seedlings are needed, the area of the nursery is wide enough so that it is related to the power to grow and the seed vigor is increased. If the nursery area is 500-538 m² / ha, a population of 800.00 is needed 0 seedlings of plant material to plant an area of 1 ha. Both locations based on population can still be maximized so that they are more efficient (Table 8).

Table 8 . Population of 3 shallot varieties originating from seeds in both locations

Variety	Broad expansion 1 m ² per plant	
	Sido Dadi farmer group, Banaran, Galur, Kulon Progo	Manunggal Farmer Group, Srigading, Sanden, Bantul
Bima	1.312	1.212
Trisula	1.348	1.248
Lokananta	1.485	1.385
CV	12.04	20.64

Description: Superscript numbers followed by different letters in the same column show results that are = 5%. (*) is significantly different at the level of 5%; (tn) α significantly different based on BNJ on not significantly different

Adaptability

Adaptation power indicates that after being removed, then being transferred to the planting area can be of good adaptation, and not stressful resulting in death. The results of the adaptation analysis at the age of 14 days showed that the Lokananta varieties were significantly better than the Bima and Trisula varieties (Table 9)

Table 9. Adaptation power of 3 shallot varieties from seeds in both locations

Variety	Adaptation Power (%) age 15 days	
	Sido Dadi farmer group, Banaran, Galur, Kulon Progo	Manunggal Farmer Group, Srigading, Sanden, Bantul
Bima	93.00 ^b	93.00 ^b
Trisula	93.00 ^b	93.00 ^b
Lokananta	99.43 ^a	99.43 ^a
CV	2.28	2.18

Description: Superscript numbers followed by different letters in the same column show results that are = 5%. (*) is significantly different at the level of 5%; (tn) α significantly different based on BNJ on not significantly different

Harvesting of the seeds is done by extracting the system by suppressing root damage and if it is too large or too thin can reduce the leaves to approximately 1/3 part. Based on observations in the TSS field with rice husk media and chopped growth chicken husks at the age of 30-35, it is quite good and maximum. The health of the seedlings in the nursery is quite good with the application of traps of pests such as Pheromone E-xi, bottle system insect traps and light trap solar power sell very effectively.

According to Basuki (2009) stated that TSS bibit planted in the field is single seed extracted one by one from the nursery. When it is revoked, the roots of the seeds are damaged (broken) and experience stress at the beginning of growth in the field. Thus increasing themortality of seedlings after planting in la food, harvesting age backwards, it can even bring down the results. Various ways to minimize damage to seed roots during transfer to the field, can be done by seeding some TSS seeds in 1 polybag or 1 hole in the nursery media. When transferring to the field, several seeds (cluster seeds) that grow in polybags or nursery media are planted at once along with the soil around the roots. The performance of seedling in two locations can be seen in the picture as below (Picture 1 and 2).

Conclusions And Recommendations

System nursery (seedlings) red shallot from TSS seed sow seeds directly (seeding) with media rice husk fuel + organic fertilizer (1: 4) and husk fuel waste chicken cage burned directly to the nursery land power grows, the growth results seedlings are healthy and good. Lokananta variety were performance better than Trisula and Bima indicated by some characters such as oplant height, total number of leaf, seedling weight and adaptation ability. Plant height of Lokananta was higher of 4.5-5.4 cm than Trisula and Bima in two locations. Leaf total number of Lokananta was also higher about 0.4 than Trisula and Bima. Seedling weight of Lokananta showed higher 0.29 g than that of trisula and Bima, meanwhile adaptation ability of Lokananta was 6.43% higher tan Trisula and Bima. Seedling of TSS actually was adapted to sand soil area.

Acknowledgements

The authors gratefully thank the Ministry of Research, Technology and Higher Education Republic of Indonesia through University of Udayana for granting research funds of PNPB Group Research program in 2018.

References

- Anonimus 2018. Hemat 77 Persen, Rahasia Teknologi Benih TSS Bawang Merah. Tribun. <https://indopos.co.id/read/2018/09/08/149353/hemat-77-persen-rahasia> teknologi-benih-tss-bawang-merah . Diunduh tgl 28 Oktober 2018.
- Basuki, R.S., 2009. Analisa kelayakan teknis dan ekonomis teknologi budidaya bawang merah dengan biji botani dan benih umbi tradisional. *J. Hort.* 19(2):21-27.
- Brewster, J. L. 2008. *Onions and Other Vegetable Allium. 2nd Edition.* New York (USA): CABI Publishing.
- Indrasari, I. 2002. Skrining ketahanan genotipe cabai (*Capsicum* sp.) terhadap penyakit antraknosa (*Colletotrichum gloeosporioides* Penz.). Skripsi. Departemen Agronomi dan Hortikultura. Fakultas Pertanian. Institut Pertanian Bogor, Bogor.
- Permadi, A.H. 1993. *Growing shallot from true seed.* Research results and problems. Onion Newsletter for the Tropics. NRI. Kingdom, July 1993(5) : 35-38.
- Putrasamedja, S. dan A.H. Permadi. 1995. Pembungaan beberapa kultivar bawang merah di dataran tinggi. *Bul. Penel. Hort.* 26(4) : 145-150.
- Rabinowitch H.D. and Kamenetsky R. 2002. *Shallot (Allium cepa var. aggregatum group).* In: H.D. Rabinowitch and L. Currah, (Eds). *Allium Crop Science: Recent Advances.* CABI Publishing. London. UK.
- Roslani, R, Sumarni, N & Suwandi 2002, 'Pengaruh kerapatan tanaman, naungan, dan mulsa terhadap pertumbuhan dan produksi umbi bawang merah mini asal biji', *J. Hort.*, vol. 12, no. 1, hlm. 28-34.
- Satmoko Budi Santoso, 2018. Pembibitan Bawang Merah, Tekan Biaya Produksi 50 Persen. <https://www.cendananews.com/2018/07/pembibitan-bawang-merah-tekan-biaya-produksi-50-persen.html>. Diunduh tgl 28 Oktober 2018
- Shavira Ayu Adinda. 2016. Pertumbuhan Dan Produksi Umbi Bawang Merah Varietas Trisula Dari Empat Bahan Tanam. Skripsi S1. Departemen Agronomi Dan Hortikultura Fakultas Pertanian Institut Pertanian Bogor 2016 PP 31.
- Sumarni N., Rosliani R, dan Suwandi. 2012b. Optimasi jarak tanam dan dosis pupuk NPK untuk produksi bawang merah dari benih umbi mini di dataran tinggi. *J. Hort.* 22(2):148-155.
- Sumarni N., Sopha G. A, dan Gaswanto R. 2010. Perbaikan teknologi produksi TSS untuk mempercepat pemenuhan kebutuhan benih bawang merah murah pada waktu tanam musim hujan. Balai Penelitian Tanaman Sayuran. Pusat Penelitian dan Pengembangan Hortikultura. Badan Penelitian dan Pengembangan Pertanian.
- Sumarni N., Sopha G. A, dan Gaswanto R. 2012a. Respon tanaman bawang merah asal biji True Shallot Seeds terhadap kerapatan tanaman pada musim hujan. *J. Hort.* 22(1):23-28.
- Sumarni N., Sumiati E dan Suwandi. 2005. Pengaruh kerapatan tanaman dan aplikasi zat pengatur tumbuh terhadap produksi benih umbi bawang merah asal biji kultivar bima. *J. Hort.* 15(3):208-214.
- Suryaningsih, E & Asandhi, AA 1992, 'Pengaruh pemupukan sistem petani dan sistem berimbang terhadap intensitas penyakit cendawan pada bawang merah (*Allium ascalonicum* L.)', *Bul. Penel. Hort.*, vol. XXIV, no. 2, hlm. 19-26.
- Suwandi, Gyna A. Sopha, dan Catur Hermanto. 2016. Petunjuk Teknis (Juknis) Proliga Bawang Merah 40 T/Ha Asal Tss (=True Shallot Seed). Balai Penelitian Tanaman Sayuran Puslitbang Hortikultura, Badan Litbang Pertanian Kementan . 11 hal.
- Udiarto B. K., Setiawati W. dan Suryaningsih E. 2005. Pengenalan Hama dan Penyakit pada Tanaman Bawang Merah dan Pengendaliannya. Balai Penelitian Tanaman Sayuran. Pusat Penelitian dan Pengembangan Pertanian. 46 Hlm.
- Walkey, D.G.A; Webb M.J.W, Bold C.J, Miller A. 1987. Production of virus free garlic (*Allium sativum* L) and Shallots (*Allium ascalonicum* L) by meristem tip culture . *J. Hort. Sci.* 62 ; 211 – 219.

Evaluation of Several Rice Varieties (*Oryza sativa* L.) in the Minapadi Cultivation System in Sleman, Yogyakarta

Kristamtini

Assessment Institute for Agricultural Technology Yogyakarta
Jl. Stadion Maguwoharjo No. 22, Wedomartani, Ngemplak,
Sleman, Yogyakarta, Indonesia
krisniur@yahoo.co.id

Sugeng Widodo

Assessment Institute for Agricultural Technology Yogyakarta
Jl. Stadion Maguwoharjo No. 22, Wedomartani, Ngemplak,
Sleman, Yogyakarta, Indonesia
Sugeng5@gmail.com

Endang Wisnu Wiranti

Assessment Institute for Agricultural Technology Yogyakarta
Jl. Stadion Maguwoharjo No. 22, Wedomartani, Ngemplak,
Sleman, Yogyakarta, Indonesia
Endangwisnu16@yahoo.co.id

Joko Pramono

Assessment Institute for Agricultural Technology Yogyakarta
Jl. Stadion Maguwoharjo No. 22, Wedomartani, Ngemplak,
Sleman, Yogyakarta, Indonesia
Maspramono64@yahoo.com

Abstract-Minapadi is fish farming in the fields along with rice cultivation. The study aims to determine the responses of several rice varieties in Minapadi cultivation. The study was conducted in Semberembe, Candibinangun, Pakem, Sleman, Yogyakarta in March until August 2018. The research was arranged factorial, the first factor was the cultivation system: minapadi and ugadi (shrimp with rice), the second factor was 4 rice varieties: Sembada merah, Inpari 30, Inpari 43, and Inpari 42. The results showed that the evaluated rice varieties differ from each other according to their genetic potential which was influenced by their growing environment. There were significant differences in all parameters, both in the treatment of varieties and cultivation systems and their interactions. The average productivity in minapadi cultivation was higher (7.79 tons / ha) than ugadi cultivation (7.24 tons / ha). The highest average productivity was achieved by Inpari 43 (8.07 tons / ha) followed by Inpari 42 (7.49 tons / ha) and Sembada variety (7.49 tons / ha), the lowest achieved by Inpari 30 (7, 00 tons / ha). The interaction of varieties and cultivation systems, the highest productivity was achieved by Inpari 43 on Minapadi cultivation = 9.58 tons / ha.
Keywords: evaluation, minapadi, Yogyakarta

Introduction

Increasing rice production was one of the targets of agricultural development, along with the increase in the population reaching 1.5% each year. Besides population growth, another challenge in agriculture is increasing land use change, the impact of climate change, decreasing land fertility, and the scarcity of agricultural labor. The area of rice harvest continues to decline due to the conversion of agricultural land which causes production to decline, while the population of Indonesia continues to increase. If this continues to occur it can cause food scarcity (Irawan, 2005). These challenges encourage to implement and explore technological innovations.

Narrow land ownership in Yogyakarta encourages to innovate by utilizing existing land. The way that can be done was to change the monoculture system to an agricultural diversification system so that the land was optimally utilized. One way that can be done was with the Integrated Fish Farming System, which was a combination

of agriculture and fisheries, such as the Minapadi business system, it was a change in the monoculture farming system towards agricultural diversification (Sudiarta *et al.*, 2016). The Minapadi farming system was one of the new transitional strategies from monoculture systems to agricultural diversification (Hadi and Umi, 2014). According to Surtida (2000), Minapadi has a long history in Indonesia, starting in the 9th century in West Java.

Minapadi was cultivating fish in rice fields along with rice cultivation. The presence of fish in the Minapadi system was thought to affect rice growth and production (Kurniasih *et al.*, 2003). Abuasir *et al.*, 2004, integrates agricultural aspects and aspects of fisheries with the application of Minapadi cultivation. The same as FAO, 2016 that the cultivation method that integrates rice and fish is very important because rice was a staple food of the Indonesian people and it was one of the commodities that support food security. According to Nurhayati *et al.*, 2016, in the ministry there was a symbiotic relationship between mutual rice, fish, water and land to achieve an ecological balance condition.

There are many advantages to using this Minapadi cultivation technique : rice fields become fertile; reduce fertilizer use; weed growth can be reduced, farmers' income increases, increasing rice production, increases land efficiency and productivity, fulfills animal protein needs, stimulates young people to enter the world of agriculture, increases income by 20%; and as a tourist place (Setiawan, 2015). The habit of fish stirring up land and preying on certain types of pests and weeds will help reduce production costs for weeding and pest control activities, and fish manure was a source of nutrients for rice plants thus saving inorganic fertilizer use (Suriapermana *et al.*, 1994; Departemen of Marine and Fisheries, 2003). Another benefit in the use of the Minapadi system was that it can eliminate weeds, and can make efficient use of water and environmental sustainability because by using the rice mina system the balance of ecosystems was more stable and can also reduce soil and water poisoning (Halwart and Gupta,

2004). Widodo, (2017) said that the cultivation of Minapadi increased rice production from 17.05 to 25.62% compared to the pattern of monoculture, soil fertility increased because there was an addition of nutrients from food and fish feces containing elements N, P, Ca and Mg.

Minapadi cultivation besides using fish commodities, can also use freshwater shrimp as one of the technological innovations promoted by the Ministry of Maritime Affairs and Fisheries through the Directorate General of Aquaculture as an alternative effort that can increase productivity and welfare of farmers. Ugadi is the cultivation of freshwater shrimp along with rice plants, in principle it is no different from the business of Minapadi with commodities of carp and tilapia. With the Ugadi method, not only freshwater shrimp are healthier but also can increase rice crop yields. Freshwater shrimp (*Macrobrachium rosenbergi* de Mann) are one of the potential freshwater commodities and are increasingly the concern of the government and aquaculture business in Indonesia (Sukadi, 2001 and Budiman, 2004).

Rice plants were planted with jajar legowo ajar planting system. Jajar legowo rice technology was an integrated rice cultivation technology based on jajar legowo cultivation methods. The jajar legowo planting system was a rice planting pattern that alternates between two or more (usually two or four) rows and one blank line. (IAARD, 2016).

Technique of rice planting techniques by planting jajar legowo 2: 1 or 4: 1, based on the results of the study proved to increase rice production by 12-22%. The Legowo system which provides a large space (aisle) was very suitable to be combined with fish maintenance (Minapadi legowo). Mahmudiyah and Soedradjad (2016), the selection of the Jajar Legowo planting system in Minapadi was because the cultivated fish still get enough space for their survival, while also facilitating the maintenance of rice and fish and in harvesting fish.

Fish products obtained are able to cover a portion of farming costs, so as to increase farmers' income. Based on farmers' income obtained through the cultivation of minapadi, farmers' income can be maximized by combining the cultivation techniques used, namely through the Jajar Legowo cultivation technique (Sukri and Suwardi, 2016).

One component of jajar legowo technology was the use of new high-potential superior varieties. The selection of rice varieties was adapted to the technology that will be applied. According to Setiawan (2015) and Sarlan (2016), rice varieties suitable for the Minapadi system were those that have characteristics: deep roots; quickly breed / germinate; strong stems and not easy to fall down; resistant to inundation at the beginning of growth; erect leaves; and resistant to pests and diseases. Anonim (2016), Indonesia planted: <https://indonesiabertanam.com/2016>, said that inundated rice varieties such as Inpara 3, Inpara 4, Inpara 5, Inpari 29, Inpari 30 (Ciherang Sub 1), Kapuas, Batanghari, and Banyuasin.

The study aimed to determine the responses of several rice varieties in Minapadi cultivation, in the hope of increasing farmers' income both from rice production and from fish production.

Materials and Methods

The study was conducted in Semberembe, Candibinangun, Pakem, Sleman, Yogyakarta in March until August 2018. The research was arranged factorial, the first factor was the cultivation system: minapadi and ugadi (shrimp with rice), the second factor was 4 rice varieties: Sembada merah, Inpari 30, Inpari 43, and Inpari 42. Inpari 30, Inpari 43 GSR (Green Super Rice) and Inpari 42 GSR were new superior varieties of INPARI crosses produced by the IAARD, while Sembada merah was superior local rice from Sleman, Yogyakarta which has been released as a local superior variety by the Ministry of Agriculture in March 2019.

Minapadi treatment, the type of fish used was tilapia measuring 15-20 tails per kg with an enlargement system with a density of 70 kg / 1000 m². The ugadi treatment using galah shrimp measures 5-6 g per tail (2 cm) with a density of 10 tails per square meter (2000 tails / 1000 m) for enlargement purposes. The fertilizer used was 2 tons / ha of organic fertilizer, 200 kg / ha of NPK and 180 kg / ha of Urea.

The "Minapadi" cultivation system used in this study was "Deep Pool of Minapadi". The Minapadi deep pool cultivation system was unique in comparison with the Minapadi in general, namely the presence of a holding pool and a portion of the pond (on the edge of the land) was made deeper to facilitate the care and harvest of fish (Lantarsih, 2016).

Parameters of observation included plant height, number of productive tillers, panicle length, number of filled grains per panicle, number of empty grains per panicle, weight of 1000 grains, and productivity. Plant height was measured from the base of the stem to the tip of the highest panicle (not including fur). The number of productive tillers was done by calculating the number of tillers that produce panicles, panicle length measured from the bottom of the panicle to the tip of the highest panicle, the number of filled grains per panicle by calculating the number of filled grains per panicle, the number of empty grains per panicle by counting the number of empty grains per panicle, weighs 1000 grains by weighing 1000 grain contents. Data hasil pengamatan dianalisis menggunakan software SAS ver 9.1.

Results and Discussion

The results of variance analysis showed that the treatment of Minapadi and Ugadi cultivation techniques had no significant effect on plant height, number of productive tillers, and panicle length, but significantly affected the number of empty grain per panicle, grain weight per clump, and productivity. The treatments of rice varieties tested and the interaction between varieties with cultivation techniques were significantly different for all parameters observed (Table 1). Sembada merah variety has the highest plant height, number of productive tillers, and highest of panicle length in Minapadi cultivation. Sembada merah variety was a local Sleman variety that has been registered at the Center for Plant Variety Registration and Agricultural Licensing and released as a national superior variety in 2019 (Republic Indonesia of Minister Agriculture Decree No. 126 / HK.540

/ C / 03/2019). As a variety from Sleman, it was more adaptive in Sleman, so that the height of the plant, the number of productive tillers, and the length of the panicles were the highest. The morphological performance was a genetic expression that was influenced by the growth environment.

The number of productive tillers was moderate, only one had a low number of productive tillers, namely Inpari 43 which was cultivated with the Minapadi system (V3M = 12.33). According to Zen *et al.* (2002), productive tillers can be grouped into three types, namely less tillers (less than 12 stems per clump), medium tillers (13-20 stems per clump) and many tillers (more than 20 stems per clump). From the results of observations (Table 1), in general all varieties tested in the cultivation of Minapadi and Ugadi included groups that had moderate productive tillers. According to Soemartono *et al.* (1980), unproductive tillers will die because of competition to get nutrients, light and water that were tight, the number of tillers will remain after the entry of pregnant stages.

Panicle length is grouped into three groups: short (≤ 20 cm), medium (20-30 cm), and long (> 30 cm) (Sajak (2012). Based on these groupings, 4 varieties tested in both cultivation systems (minapadi and ugadi) belong to the medium long panicle group. The results of the further test in Table 1 show the panicle length between one variety and the other varieties were significantly different according to the genetic potential of each variety which was influenced by the growing environment.

Table 1. Effect of varieties and cultivation techniques and their interactions on plant height, number of productive tillers, number of filled grains per panicle, number of empty grains per panicle, weight of 1000 grains, weight of grain per clump and productivity

Treatment	Plant height (cm)	Panicle length (cm)	Number of productive tillers	Total grain content / panicle	Amount of grain / panicle	Weight of 1000 grains (g)	Weight of grain per clump (g)	Productivity (ton/ha)
Variety (V)								
<i>Sembada Merah (V1)</i>	11,075 a	24,72 a	16,67 a	12,95 a	12,27 bc	22,9 bc	41,08 ab	7,49 b
<i>Inpari 30 (V2)</i>	98,58 b	22,84 b	14,58 b	11,786 a	5,75 d	26,4 a	41,60 a	7,00 c
<i>Inpari 43 (V3)</i>	86,33 c	21,80 c	13,83 b	12,764 a	10,13 b	21,0 c	35,79 b	8,07 a
<i>Inpari 42 (V4)</i>	83,83 c	20,50 d	14,58 b	13,672 a	27,67 a	23,5 b	42,97 a	7,49 b
Cultivation techniques								
Minapadi (M)	94,41 a	22,30 a	15,20 a	12,156 a	11,8 b	24,0 a	42,92 a	7,79 a

Ugadi (U)	95,33 a	22,63 a	14,62 a	13,487 a	20,77 a	22,89 a	37,80 b	7,24 b
Interaction variety and cultivation techniques								
V1M	109,83 a	24,52 a	16,83 a	11,548 ab	12,32 cd	23,0 b	41,48 a-c	7,61 b
V2M	97,16 b	21,84 b	15,00 ab	10,017 b	5,05 d	26,50 a	46,78 ab	6,52 c
V3M	81,00 d	22,03 b	12,33 b	12,9, a	22,25 b	23,17 b	33,98 c	9,58 a
V4M	89,66 c	20,84 bc	14,33 ab	14,067 a	43,00 a	23,33 b	49,43 a	7,42 b
V1U	116,66 a	24,93 a	16,50 a	14,3, a	12,21 cd	22,75 b	41,68 bc	7,37 b
V2U	100,00 b	23,84 a	14,16 ab	13,7,56 a	6,44 d	26,33 a	36,41 c	7,48 b
V3U	91,66 c	21,58 bc	15,33 ab	12,5,33 ab	15,72 bc	18,8 c	37,59 c	6,65 c
V4U	78,00 d	20,16 c	14,83 ab	13,2,78 a	12,33 cd	23,67 ab	36,50 c	7,55 b
CV (%)	4,89	5,48	15,55	18,15	39,33	9,99	16,25	

Description: Numbers followed by the same letters in the same row and column were not significantly different according to Duncan's Multiple Distance Test at the level of 5%

The yield potential was determined by the yield component consisting of the number of productive tillers, number of filled grains per panicle, weight of grain per clump and weight of 1000 grains. Purohit and Majumder (2009) stated that yield potential was influenced by the character of the number of productive tillers, the number of filled grains per panicle, and the weight of 1000 grains of grain. Table 1 shows that each of the varieties tested was significantly different from one another which was influenced by the growing environment, which was cultivated with the Minapadi and ugadi systems.

The ability of rice varieties to be able to adapt to their growing environment was shown by productivity achievements. The productivity of 4 varieties tested in the cultivation of Minapadi and also different between varieties. The highest average productivity was shown by Inpari 43 rice which was 8.07 tons / ha, productivity in Minapadi cultivation appeared to be higher (7.79 tons / ha) than the ugadi system (7.24 tons / ha). The interaction of varieties and cultivation systems had a significant effect and the highest productivity was indicated by Inpari 43 varieties cultivated in the Minapadi system (V3M = 9.58 tons / ha). The increase in grain yield in many types of panicles resulted from the increasing number of panicles, while the increase in grain yield from the type of heavy panicles resulted from the addition of weight of each panicle (Vergara, 1995).

The high productivity in **Minapadi** cultivation was both a single factor of the cultivation system and the interaction of varieties with the cultivation system due to the

fact that the **ugadi** cultivation was the first cultivation system in the field compared to the cultivation of Minapadi so that adaptation was still needed. However, cultivated giant prawns can still develop well. The high productivity of Inpari 43 rice varieties in Minapadi cultivation caused of genetically the Inpari 43 variety was a rice variety called Inpari 3 Green Super Rice (GSR). Inpari 43 GSR was high yielding rice both at optimum conditions and in limited environmental conditions. Green emphasizes its ability to produce high yield even at relatively low input conditions; while Super emphasizes its ability to provide high yields (IAARD in Unsurtani, 2017).

Conclusion

The evaluated rice varieties differ from each other according to their genetic potential which was influenced by their growing environment. The average productivity in Minapadi cultivation was higher (7.79 tons / ha) than ugadi cultivation (7.24 tons / ha). The highest productivity was achieved by Inpari 43 (8.07 tons / ha) followed by Inpari 42 (7.49 tons / ha) and red Sembada (7.49 tons / ha), the lowest achieved by Inpari 30 (7.00 tons / Ha). The interaction of varieties and cultivation systems had a significant effect and the highest productivity was indicated by Inpari 43 varieties cultivated in the Minapadi system (V3M = 9.58 tons / ha).

References

- Abuasir, S., Hakim, N., and Sumitro, Y. (2004). Factors Affecting Adoption of Minapadi Farming Systems in Pujo Rahayu Village, Belitang, Ogan Komering Ulu. *Journal of Communication and Community Development*, 1(1), 30–37.
- Anonym. (2016). Choose rice seeds that match the characteristics of the land. <https://indonesiabertanam.com/2016/09/02/pilihlah-varietas-benih-padi-yang-sesuai-karakteristik-lahan/>. Download 20 Maret 2019.
- Budiman, A.A. 2004. *Development of Gimacro Shrimp in Indonesia. Gimacro Galah Prawns Business National Meeting in Yogyakarta*. 22-23 Juni 2004. 11 hlm.
- Departemen of Marine and Fisheries of the Republic of Indonesia). (2003). Cultivation of a Profitable Mina Fish System. Magazine of Demersal. Departemen of Marine and Fisheries of the Republic of Indonesia.
- FAO. (2016). Knowledge exchange on the promotion of efficient rice farming practices, farmer field school curriculum development and value chains (Vol. 1181).
- Hadi, P. And Astuti, U.P. (2014). *Maintenance of Fish Rice in Rice Fields (Minapadi), A Potential Double Benefit for Farmers in Bengkulu Province*. Agriculture and Food Crop Service.
- Halwart, M. dan Gupta, M.V.. (2004). Culture of Fish in Rice Fields. Rome : FAO and The World Fish Center. 19 Agritrop, Vol. 16 (1): 17 – 37.
- Institute of Agricultural Agency Research and Development (IAARD), (2016). Technical Instructions for Jajar Legowo Super of Rice Cultivation. IAARD. Ministry Agriculture of Republic of Indonesia.
- Irawan, B. (2005). Rice Field Conversion has a Negative Impact on Food Security and Environmental. *Agricultural Research and Development News* Vol. 27 No. 6. Center Analysis for Agricultural of Socio Economic and Policy, Bogor.
- Kurniasih A., Wahyu, Q., and Mugnisjah. (2003). *Effect of Rice Planting System (Oryza sativa L.) And Fish Population on Growth and Production in the Minapadi System*. *Jurnal. Gakuryoku* 9. (1); 36-42.
- Lantarsih, R. 2016. Pengembangan “MinapadiKolam Dalam” di Kabupaten Sleman. *Jurnal Agraris* Vol.2 No.1 Januari 2016. DOI:10.18196/agr.2122
- Mahmudiyah, E., Soedradjad, R. (2016). Effect of Organic Fertilizers and Cultivation Techniques on Rice and Fish Production in the Minapadi System. *Agritrop* *Jurnal* Vol. 16 (1). <http://jurnal.unmuhjember.ac.id/index.php/AGRITROP> . Juli 2018.
- Nurhayati, A., Lili, W., Herawati, T., and Riyantini, I. (2016). Derivatif Analysis of Economic and Social Aspect of Added Value Minapadi (Paddy-fish Integrative Farming) a Case Study in the Village of Sagaracipta Ciparay Sub District, Bandung West Java Province, Indonesia. *Aquatic Procedia*, 7, 12–18. <https://doi.org/10.1016/j.aqpro.2016.07.002>
- Purohit S, Majumder MK. (2009). Selection of high yielding rice variety from a cold tolerant three-way rice (*Oryza sativa L.*) cross involving Indica, japonica and wide compatible variety. *Middle-East Journal of Scientific Research*. 4(1):28-31.
- Sajak, A. (2012). Characterization Morphology of Local Rice Germplasm from Tana Toraja Utara, South of Sulawesi. Hasanudin University. South of Sulawesi. Hal 1-7
- Sarlan. (2016). Suitable characters, Inpari 29 and Inpari 30 (Ciherang Sub1) Can Optimize Minapadi. <https://jogiadaily.com/2016/02/karakter-cocok-inpari-29-rendaman-dan-inpari-30-ciherang-sub1-dapat-optimalkan-mina-padi/>. **Diunduh 19 Maret 2019.**
- Setiawan, H.D. (2015). Minapadi, farmers profit and land use change was reduced. http://www.kompasiana.com/penyuluhan_perikanan/minapadi-petani-untung-dan-alih-fungsi-sawah-dapat-berkurang. **diunduh Mei 2017.**
- Soemartono, B. and Hardjono, R. (1980). *Rice Planting*. C.V. Yasaguna, Jakarta.
- Sudiarta, I.M., Syam'un, E., and Syamsuddin, R. (2016). Growth and Production of Rice Plants and Tilapia Production in the Jajar Legowo Planting System. *J. Sains & Teknologi*, April 2016, Vol.16 No.1 : 70 – 80.
- Sukadi, F. 2001. Policy for the Development of Giant Prawn Cultivation (*Macrobrachium rosenbergii*). Proceedings of the Research Workshop on Giant Shrimp Cultivation. Center for Aquaculture Research. Maritime and Fisheries Research Agency, Ministry of Maritime Affairs and Fisheries. 11-14 hlm.
- Sukri, M. Z. and Suwardi. (2016). Farmers Group of Minapadi Intensification System Program (Insismindi). *Dinamika*, 1(1) : 53-60.
- Suriapermana, S., Syamsiah, I., Wardana, P., Arifin, Z., and Fagi, A.M. (1994). Minapadi Farming with Environmental Insight Increases Income. Food Crop Research and Development Center. IAARD. Jakarta.
- Surtida, A. P. (2000). Rice-fish culture systems. *SEAFDEC Asian Aquaculture*, XXIII(6), 22–23
- Unsurtani, 2017. Get to know rice varieties of Green Super rice (GSR) : Inpari 42 dan Inpari 43. <https://unsurtani.com/.../mengenai-varietas-padi-green-super-rice-gs>. **Download 13 Juli 2019.**
- Vergara, B.S. (1990). *Rice Planting*. Proyek Prasarana Fisik Bappenas, Jakarta.
- Widodo, S. (2017). Financial Analysis of Rice New Superior Varieties in the Minapadi system with Jajar legowo technology in Sleman Regency, Yogyakarta. Proceedings of the National Seminar on the Indonesian Agronomy Association. July 19, 2017.
- Zen, S., Zarwan, H., Bahar., Dasmal, F., Artati, Aswardi, and Taufik. (2002). Assessment of Specific Rice Field Varieties in West Sumatra Consumer Preferences.. West Sumatra Agricultural Institute for Agriculture Technology. Agriculture Department.

Growth and Production of Shallots (*Allium ascolanicum* L.) by Application of Vermicompost and Liquid Organic Fertilizer of Lamtoro Leaves

Wan Arfiani Barus
Agrotechnology, Faculty of Agriculture
University of Muhammadiyah Sumatera
Utara
Medan, Indonesia
wanarfianibarus@umsu.ac.id

Hadriman Khair
Agrotechnology, Faculty of Agriculture
University of Muhammadiyah Sumatera
Utara
Medan, Indonesia

Muhammad Wira Ifandi
Agrotechnology, Faculty of Agriculture
University of Muhammadiyah Sumatera
Utara
Medan, Indonesia

Abstract— Support for sustainable agriculture is to utilize organic fertilizer. Organic fertilizers which are currently widely used are organic fertilizers from organism faeces and plant materials as well as in this study. The aim of this research was to determine the response of the vermicompost organic fertilizer and Liquid Organic Fertilizer leaves of Lamtoro to the growth and production of Shallot. This research used a Randomized Block Design (RBD) consisting of two factors. The application of Vermicompost (K) consisted of four levels, 100, 200 and 300 g/polybag. The second factor is the Application of Lamtoro leaf liquid organic fertilizer (P) consists of four dosage levels: 0, 100, 200 and 300 ml/polybag. The results showed that the application of vermicompost organic fertilizer showed a significant effect on all parameters studied except for the parameters of the number of tillers. Whereas, the application of Liquid Organic Fertilizer of Lamtoro leaf showed no significant effect on all parameters observed. Furthermore, there was no interaction of the application of Vermicompost organic fertilizer and Liquid Organic Fertilizer of Lamtoro leaf on the growth and production of shallots.

Keywords— Lamtoro, Liquid Organic Fertilizer, Shallots, Vermicompost

INTRODUCTION

Shallots (*Allium ascolanicum* L.) is one of the world's main cooking spices originating from Iran, Pakistan and the mountains in the north and Central Asia, which are around India, Pakistan, and Palestine [1], but then spread to various directions world, both subtropics and tropical. Shallots plants are horticultural plants that are increasingly gaining attention both from the community and the government. Over the past few years, shallots include six major commodities of vegetables exported together with cabbage, cabbage flowers, chilli, tomatoes, and potatoes. Even Shallots are not only exported in the form of fresh vegetables but also after they are processed into fried onion products [2]. Generally, shallots are propagated using tubers[3]. The quality and quantity of shallot production are very much determined by the cultivation techniques in the field, especially on the condition of the land. The current condition of agricultural land is quite alarming where not a few agricultural lands have been damaged due to continuous land use and chemical fertilizers which have caused the productivity of shallots to [4]. Therefore the Shallots cultivation technique is highly recommended organically, namely by utilizing organic ingredients as a source of nutrients so that the land used is maintained in a sustainable

manner. Several types of organic fertilizers have been used. Organic fertilizers are fertilizers which are mostly composed of material living things such as weathering the remains of plants, animals and humans. Based on the shape, organic fertilizer can be divided into two parts, solid organic fertilizer and liquid organic fertilizer. Liquid organic fertilizer is a type of organic fertilizer in the form of liquid. The advantages of liquid fertilizer are being able to provide nutrients for plants without damaging nutrients in the soil and more easily absorbed by plants [5]. The use of organic fertilizers is very safe for health and environmentally friendly. Fertilizing materials that can be used, one of which is vermicompost or which is often called worm maintenance impurities. Vermicompost is one of the organic fertilizers that has advantages from other organic fertilizers, so it is often called "organic fertilizer plus". Vermicompost is an earthworm drop which is a very good organic fertilizer because the nutrients contained directly can be available to plants so that the quality of vermicompost is much better than other organic fertilizers [6].

The use of vermicompost has several advantages, namely helping to overcome environmental waste, improving soil nutrients both macro and micronutrients, increasing crop production and crop protection (www.atmago.com). The use of organic fertilizer to be more optimal can be applied with liquid organic fertilizer. One of the plant material that can be used as a liquid organic fertilizer is the leaves of Lamtoro. Lamtoro is a plant that has a high nutrient content that is needed by plants. Lamtoro leaves contain 3.84% N; 0.20% P; 0.20% K; 1.31% Ca and 0.33% Mg (Racham, 2002). Lamtoro plants can be used to increase soil fertility because Lamtoro plants are able to bind nitrogen and produce many leaves as a source of organic matter. In addition, it can also be used as a protective plant and terrace reinforcement because these plants have a strong root system (Purwanto, 2007).

MATERIALS AND METHODS

The study was conducted at the experimental field of the Faculty of Agriculture, Muhammadiyah University of North Sumatra Jl. Tuar no. 65 sub-districts of Medan Amplas with an altitude of ± 27 m asl, in February-April 2018. This study used a randomized block design (RBD) consisting of two factors. The first factor is vermicompost application with a symbol (K) consisting of four levels, namely K0: Control, K1: 100 g/polybag, K2: 200 g/polybag and K3: 300

g/polybag. The second factor is the application of liquid organic fertilizer of Lamtoro leaves with a symbol (P) consisting of four levels, namely P0: Control, P1: 100 ml/polybag, P2: 200 ml/polybag and P3: 300 ml/polybag.

RESULT AND DISCUSSIONS

Test the quality of oil palm varieties D x P 540 NG

The application of Lamtoro leaf liquid organic fertilizer has no significant effect on all observed observation variables, but instead Vermicompost application significantly affected plant height, leaf number, plant wet weight per sample, plant wet weight per plot, plant dry weight per sample, plant dry weight per plot, tuber weight per sample, dry weight of tubers per plot. However, it does not significantly affect the number of tillers. The vermicompost organic fertilizer has a significant effect on the height of shallot plants, where the results showed increase along with the increase in the dosage/level of vermicompost given organic fertilizer. The relationship between the height of the Shallots plant and the

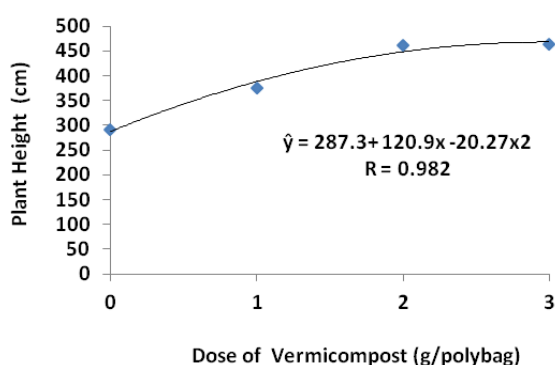

administration of vermicompost organic fertilizer can be seen in Fig. 1.

Plant Height of Shallots by The Application of Vermicompost

Based on Figure 1, the height of the shallot plants tends to increase along with the increase in the vermicompost organic fertilizer given. Fahrudin [9] which states that vermicompost contains various nutrients needed by plants such as N, P, K, Ca, Mg, S, Fe, Mn, Al, Na, Cu, Zn, Co, and Mo. In addition, the quality of seeds and environmental factors greatly affect plant growth. Organic vermicompost is a fertilizer derived from the results of worm metabolism in the form of dirt. According to Zubachtirodin (2008) which says that plant height is influenced by the provision of nitrogen which can increase plant height to 35 cm higher than plants that are not given nitrogen. Each treatment gave a different influence on plant height. The difference in plant height is caused by the ability to absorb different nutrients in each plant. The higher the concentration of fertilizer given, the faster the development of organs such as roots, so that plants can absorb more nutrients and water that is on the ground which in turn will affect plant height. But plants also have a certain limit in absorbing nutrients. According to [11] differences in the rate of growth and activity of merismatic tissues that are not the same cause differences in the rate of formation of organs that are not the same as in leaf organs, stems, and other organs. The number of red onion leaves

with the treatment of vermicompost organic fertilizer can be seen in Figure 2. Based on Figure 1, the height of the shallot plants tends to increase along with the increase in the vermicompost organic fertilizer given. Fahrudin [9] which states that vermicompost contains various nutrients needed by plants such as N, P, K, Ca, Mg, S, Fe, Mn, Al, Na, Cu, Zn, Co, and Mo. In addition, the quality of seeds and environmental factors greatly affect plant growth. Organic vermicompost is a fertilizer derived from the results of worm metabolism in the form of dirt. According to Zubachtirodin (2008) which says that plant height is influenced by the provision of nitrogen which can increase plant height to 35 cm higher than plants that are not given nitrogen. Each treatment gave a different influence on plant height. The difference in plant height is caused by the ability to absorb different nutrients in each plant. The higher the concentration of fertilizer given, the faster the development of organs such as roots, so that plants can absorb more nutrients and water that is on the ground which in turn will affect plant height. But plants also have a certain limit in

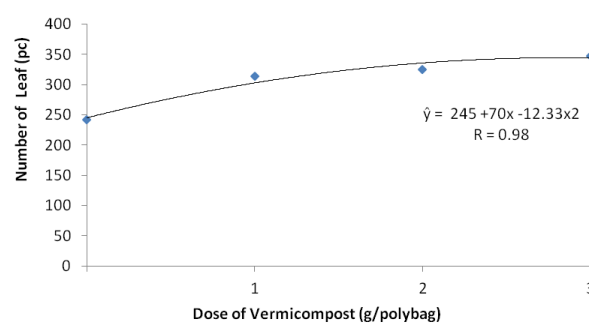

absorbing nutrients. According to [11] differences in the rate of growth and activity of merismatic tissues that are not the same cause differences in the rate of formation of organs that are not the same as in leaf organs, stems, and other organs. The number of red onion leaves with the treatment of vermicompost organic fertilizer can be seen in Figure 2.

Leaves Number of Shallots by Vermicompost Application

The application of vermicompost to a dose of 300 g/polybag tends to increase the number of shallots in a quadratic manner. Vermicompost organic fertilizers are fertilizers derived from worm feces that are rich in nutrients, especially nutrients N which can accelerate the process of photosynthesis so that the formation of plant organs, especially in leaves, becomes faster. The absorption of nutrients by plants from the soil that is absorbed to the maximum can produce optimal growth of shallots. According to [12] who stated that vermicompost is an organic material that can improve soil productivity physically, chemically and biologically. Physically, compost can loosen the soil, improve aerase and drainage, increase binding between particles and the binding capacity of water so that it can erode erosion and landslides, reduce the washing of nitrogen and improve soil tillage. The wet weight of shallots per plant by vermicompost fertilizer application can be seen in Figure 3.

In Figure 3, the wet weight of Shallots plants by giving organic fertilizer vermicompost forms a civil relationship. It can be explained here that vermicompost causes an increase

in the percentage of carbohydrates and some macronutrients. Carbohydrates in plants are used as food reserves for growth and their effects directly affect plant physiology. This is in accordance with the nature of the literature of Hameeda et al. (2007), which states that compost doses are also very influential for plant growth and yield because, in addition to being a source of nutrients for plants, compost is also a place for millions of soil microorganisms to develop plants. Furthermore, the dry weight of shallots with the treatment of vermicompost organic fertilizer can be seen in Figure 4.

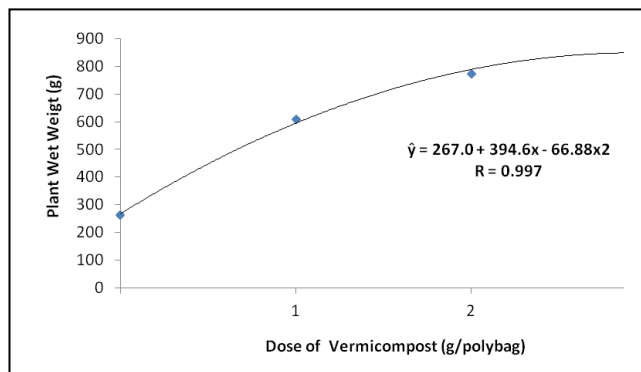

Plant Wet Weight of Shallots by Vermicompost

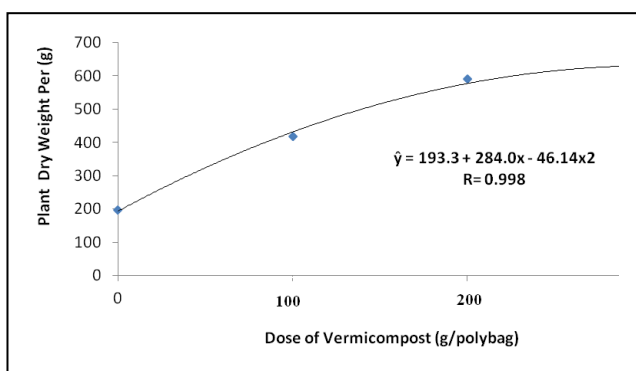

Application

Dry Weight of Shallots Plants By Vermicompost Application

In Figure 4, it can be seen that the dry weight of shallot plants by giving Vermicompost organic fertilizer forms a kinetic relationship, where the treatment of vermicompost organic fertilizer has a very significant effect on dry weight per shallot plant, this is in accordance with the plant wet weight parameters which have a very significant effect and influence by the number of leaves because the leaves are a place for the accumulation of photosynthate plants. Each plant has a different tolerance to sunlight. The increase in photosynthesis process will increase the results of photosynthesis in the form of organic compounds that will be translocated to all plant organs and affect the dry weight of plants. According to [14] dry weight is an indication of the success of plant growth, because dry weight is an indication of the presence of clean photosynthesis that can be deposited after the water content is dried. Dry weight shows the ability of plants to take nutrients from the growing media to support their growth. Increased plant dry weight related to plant metabolism or the existence of plant growth conditions that are better for the ongoing metabolic activities

of plants such as photosynthesis. Thus, the greater the dry weight shows the photosynthesis process takes place more

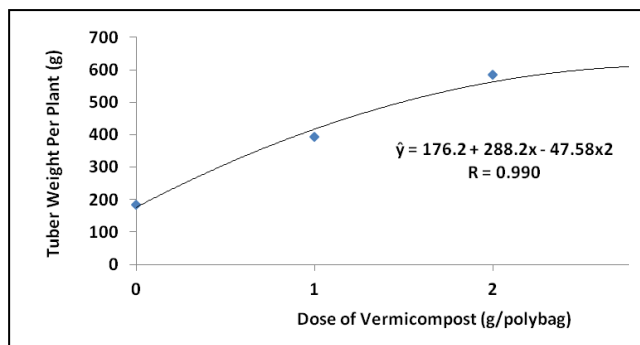

efficiently. The greater the dry weight, the more efficient the photosynthesis process occurs, and the productivity and development of tissue cells is higher and faster, so that plant growth gets better. Furthermore, the weight of shallot bulbs per plant with organic fertilizer vermicompost treatment can be seen in Figure 5.

In Figure 5, the weight of onion bulbs per plant by giving organic fertilizer vermicompost forms quadratic, where the results obtained increase along with the filling of doses of vermicompost organic fertilizer on shallots. The bulb weight of the onion plant per plot with the treatment of organic vermicompost can be seen in Figure 6.

Tuber Weight per Plant of Shallots Plants by Vermicompost Application

In Figure 6, it can be seen that the shallot tuber weight per plot by giving vermicompost organic fertilizer forms a kinetic relationship, wherein K2: 200 g / polybag treatment it gives optimal results. It is presumed that the population of shallot plants with the treatment of vermicompost organic fertilizer in the treatment of K2 has a higher quality of growth and production. Because it is known that each plant absorbs different nutrients. Apart from the plant factors themselves, external factors are also very influential on plant growth such as climate and environmental factors and the most important is the disease that attacks the plant.

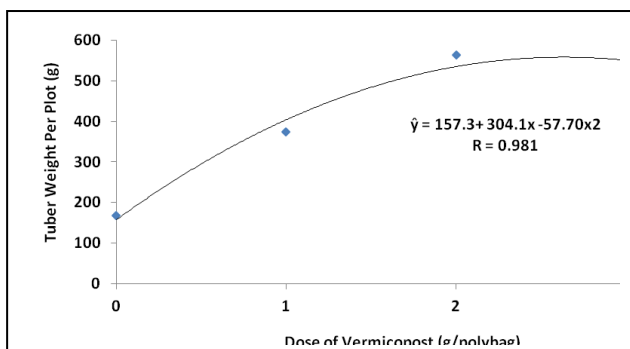

Tuber Weight per Plot of Shallots Plants by Vermicompost Application

CONCLUSION

Vermicompost Organic Fertilizer has a significant effect on all parameters of observations, namely: plant height, leaf number, wet weight per plant, dry weight per plant, wet weight per plot, dry weight per plot, tuber weight per plant

and tuber weight per plot. But it does not have a real effect on the number of tillers. However, liquid organic fertilizer of Lamtoro leaf did not have a significant effect on all observed parameters.

REFERENCES

- Basuki, R.S. 2009. Analisis Kelayakan Teknis dan Ekonomis Teknologi Budidaya Bawang Merah dengan Benih Biji Botani dan Benih Umbi Tradisional. *J. Hort.* 19(2):214-227.
- Syakur, Abd., Latarang, B. 2008. Pertumbuhan Dan Hasil Bawang Merah Pada berbagai Dosis Pupuk Kandang (*Allium ascalonicum L.*) September 2006. ISSN : 0854 - 641X.
- Deviana, W., Meirani., S. Silitonga. 2014. Pertumbuhan Dan Produksi Bawang Merah (*Allium ascalonicum L.*) Dengan Pembelahan Umbi Bibit Pada Beberapa Jarak Tanam. ISSN No. 2337- 6597 Vol.2, No.3 : 1113 - 1118, Juni 2014.
- Tambunan., Sipayung, R dan sitepu, F, E. 2014. Pertumbuhan Dan Produksi Bawang Merah (*Allium ascalonicum L.*) Dengan Pemberian Pupuk Hayati Pada Berbagai Media Tanam. ISSN No. 2337- 6597 Vol.2, No.2 : 825 - 836, Maret2014.
- Rita Listiyana. 2016. Pemanfaatan Daun Lamtoro Dan Ekstrak Tauge Dengan Penambahan Urine Sapi Untuk Pembuatan Pupuk Organik. Skripsi Publikasi ilmiah. Universitas Muhammadiyah Surakarta.
- Atmaja., Lestari, A, P. 2015. Pengembangan Pertanian Berkelanjutan Melalui Substitusi Pupuk Anorganik Dan Pupuk Organik. ISSN 1410-1939.
- Fahrudin F. 2009. Budidaya Caisim (*Brassica Juncea L.*) Menggunakan Ekstrak The dan Pupuk Kascing, Universitas Sebelas Maret, Surakarta.
- Lestari, W. Novilda, E dan Maxwell. 2015. Respon Pemberian Pupuk Organik (POC) Limbah Sayuran Terhadap Pertumbuhan Dan Produksi Tanaman Tomat (*Lycopersicum asculentum L.*). *Jurnal Agroplasma (STIPER) Labuhan batu.* Vol 2 N0 1 Mei 2015.
- Prasetyo, H. 2010. Pengaruh Dosis Pupuk Kascing Dan Hasil Tiga Varietas Bawang Merah. Dikutip dari <http://student-research.umm.ac.id>. Diakses tanggal 05 September 2018.
- Prayudyarningsih, R dan H. Tikupadang. 2008. Percepatan pertumbuhan Tanaman Bitti (*Vitex Cofasuss Reinw*) dengan aplikasi fungsi Mikorisa Arbuskula (FMI). Balai Penelitian Kehutanan Makassar.

Utilization of RAPD Markers to Analysis Genetic Diversity Oil Palm (*Elaeis guineensis* Jacq.)

Sri Mekar Melati

Agrotechnology, Faculty of Agriculture
University of Sumatera Utara
Medan, Indonesia

Lollie Agustina P. Putri

Agrotechnology, Faculty of Agriculture
University of Sumatera Utara
Medan, Indonesia

Eva Sartini Bayu

Agrotechnology, Faculty of Agriculture
University of Sumatera Utara
Medan, Indonesia
evagirsang61@gmail.com

Asni

Biotechnology Laboratory, Faculty of
Agriculture
University of Sumatera Utara
Medan, Indonesia

Khoirunnisa Lubis

Agrotechnology, Faculty of Agriculture
University of Sumatera Utara
Medan, Indonesia

Abstract— Genetically, each individual in one variety of oil palm is varied, both from the level of relationship and the level of diversity. Genetic diversity could be determined used one of the molecular markers, such as RAPD. The study was aimed to determine genetic diversity of oil palm (*Elaeis guineensis* Jacq.) DxP 540 NG variety a *Ganoderma* moderately resistant using 3 RAPD markers. The study was conducted at the Biotechnology Laboratory, Faculty of Agriculture, University of Sumatera Utara, Medan. The genetic materials analyzed came from 20 of oil palm DxP 540 NG variety using OPM-01, OPD-20, OPD-13 marker. Genetic bands size measured using UVITEC Cambridge FireReader, genetic distances calculations obtained Principal Coordinates Analysis (PcoA) and Neighbor-Joining Tree (NJTree) analysis using software. The results showed that the 20 plants had genetic distances ranging 0 – 0,60 and were divided into 3 main groups with unqualified molecular diversity of 54,31%.

Keywords— oil palm, genetic diversity, DxP 540 NG, RAPD

INTRODUCTION

Palm oil (*Elaeis guineensis* Jacq.) it is one of the commodities of plantation products which plays an important role in the economy in Indonesia [1]. The area of oil palm smallholder plantations in the province of North Sumatra in 2017 reached an estimated number of 429,951 hectares and a production rate of 1.3 million tons. The volume and export value of palm oil (CPO) in 2016 was 12 million tons [2].

One of the obstacles in oil palm plantations is stem rot disease caused by *Ganoderma boninense* [3]. Genetic material with *Ganoderma* moderately resistant characteristic is a key element in the use of molecular diagnostics to improve seed quality and oil palm productivity [4]. Observation to find the best genetic character is needed. The identification at the molecular level is the activity to evaluate genetic diversity in DNA level at the genom of plant [5].

D x P 540 NG variety is a genetic material of IOPRI (Indonesian Oil Palm Research Institute) descended from SP540T that has resistance to *Ganoderma* and has selected 43 crosses which have an index of disease incidence of less than 70 disease and less than resistant control crossing index, so that its considered as a cross that has *Ganoderma* moderately resistant variety named D x P 540 NG. NG means New Generation for *Ganoderma* [6].

High genetic diversity is one of the important factors for the development of genetic resources needed in plant breeding [7]. Genetic resources at the genotypic level, can use DNA to determine certain character diversity in oil palm because DNA in a plant did not change and is not influenced by environmental factors [8].

Therefore this study aimed to analyze genetic diversity which refers to the development and production of a molecular-based *Ganoderma* moderately resistant of oil palm genotype using RAPD markers which is one of the DNA markers that use working principle of a chain polymerization reaction using a PCR (Polymerase Chain Reaction) machine and can provide a large number of polymorphisms [9]. The RAPD marker is obtained by amplifying a DNA random (random) segment from a single primary arbitrage [10]

MATERIALS AND METHODS

Plant Material and DNA Isolation

The planting material used in this study was 20 the young leaves oil palm of D x P 540 NG variety which were released by IOPRI. The extraction and isolation of genomic DNA was performed by genomic DNA isolation procedures adapted from the CTAB method by [11] with some modifications to the concentrations of polyvinylpyrrolidone (PVPP) and 2-mercaptoethanol [12]. The quantity of each isolated DNA was measured with a nanodrop spectrophotometer while its quality was electrophoresed on 0.8% electrophoresis gel. The material genetics (genomic DNA) were stored at -45 °C.

DNA Amplification

DNA amplification based on the method [13] was carried out total volume 15µl, 2µl of DNA extract added to 7.5µl reaction mix (Go Green Taq Promega) 4.5µl nuclease free water, 1µl random primer. Amplification using 3 primers is OPM-01, OPD-20, OPD-13. The amplification reaction Gene Amp PCR Applied Biosystem was designed for 45 times the time, temperature and thermal cycle used in oil palm plants, shown in Table 1.

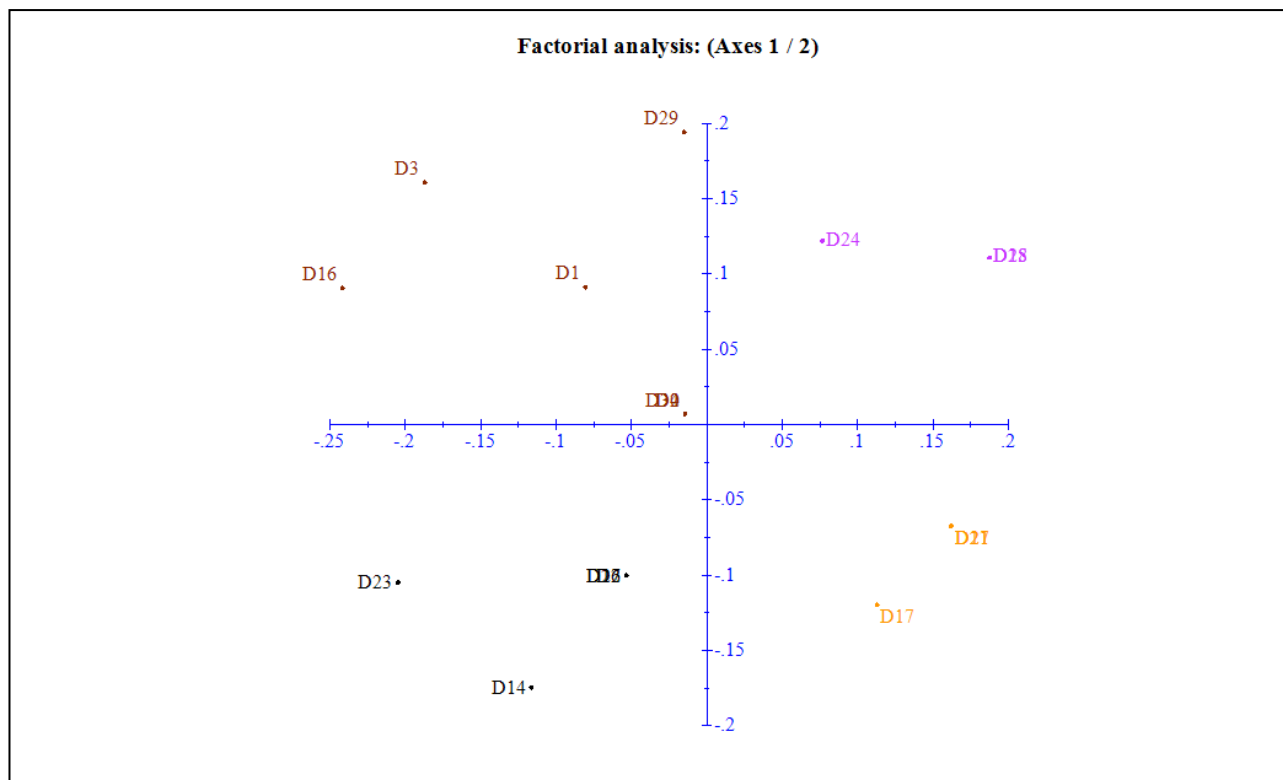

Factor analysis of PCoA (Principal Coordinates Analysis) axis 1 (horizontal) and axis 2 (vertical) based on dissimilarity simple matching matrix using 3 RAPD primers.

individuals. This calculation and descriptive analysis uses DARwin 6.0 software [14].

RESULT AND DISCUSSIONS

The amplified products added 1.5µl loading dye and resolved 1.3% agarose gel containing ethidium bromide in horizontal electrophoresis tank containing TAE buffer at 46 volts for 2 hours. The amplified RAPD patterns were analysed with the Gel Doc UVITEC Cambridge FireReader identified according to base pair size. Molecular sizes of amplified products were estimated using a 1kb DNA ladder marker (Promega).

Analysis of genetic relations using PCoA (Principal Coordinates Analysis) in the DARwin 6.0 software produced 32.73% inertia at axis 1 and 21.58% inertia at axis 2 (Fig. 1). So, the total molecular diversity that can be explained is equal to 54.31% showed the highest individuals dissimilarity in a population. Kularatne et al [15] also reported the presence of high overall genetic diversity among Nigerian oil palms and the genetic diversity gradually decreased in Senegal and Gambia, and also in Angola and Tanzania. Ghana oil palms were less diverse, while oil palms from Guinea showed a comparatively higher diversity.

CYCLE, PROCESS, TEMPERATURE AND TIME OF LEAF OIL PALM DNA AMPLIFICATION

No.	Stages	Temperature	Time (Minute)	Number of Cycles
1	Early Denaturation	94° C	1	1
2	Denaturation	94° C	1	45
3	Annealing	36° C	1	45
4	Extention	72° C	2	45
5	Final Extention	72° C	4	1

Genetic distance between samples can be seen based on PCoA data with the highest dissimilarity value of 0.60 (Fig. 1) between D13 with D9, D16 with D13, D9 with D13. And the lowest value is 0 in most of the dissimilarity values between samples tested. The lowest value indicates that the sample has minimal heterozygosity. That was consistent with the study of [16] which states that the level of genetic diversity detected for each population is 0.28, 0.22 and 0.21 for further Yagambi, Lame and Lame cross, respectively, indicating that the population has little genetic variation. Maximum heterozygosity for RAPD is 0.5.

Each RAPD band is considered a single locus, only locus showing clearly defined used for scoring: there are (1) and empty (0). The distance matrix or genetic inequality for all combinations of individual pairs can be performed with two types of descriptive analysis of diversity: (i) Principal Coordinates Analysis (PCoA), a factorial analysis type in the inequality table for the main group origin and (ii) Neighbor-Joining Tree (NJtree) to obtain a picture of kinship among

Clusters are generated through the Radial Neighbor Joining Tree (NJTree) analysis which is three clusters. Each cluster (Fig. 2) has an identical percentage of 100%. There are 7 samples in cluster I, namely D11, D17, D18, D21, D24, D25, D27. In cluster II there are 4 samples, namely D2, D4, D29, D30. And in cluster III there are 8 samples, namely D1, D3, D7, D12, D14, D16, D23, D26. In one variety it can be divided into 3 groups because it is based on the genetic distance each individual has. To form and divide into one cluster can be seen

through close genetic distance and interrelated material. The close genetic distance between individuals indicates the similarity of genetic material in one cluster even though it

comes from the same variety. This is consistent with the statement of [17] which states that close genetic distance can be caused by the same genetic source but spread in various places. In each cluster the level of genetic similarity between samples is quite high. According to [18] the higher the genetic similarity coefficient value, the more individual grouping occurs.

The results of observations from 20 samples using three RAPD primers contained 1 individual that could have not analysis by the DARwin 6.0 software. That is to the individual D22, because the amount of scoring data for the sample did not meet the standardized requirements. This happens because the D22 individual did not amplified using the OPD-20 primer. Ribbon scoring data is very important for the analysis process in DARwin 6.0 software.

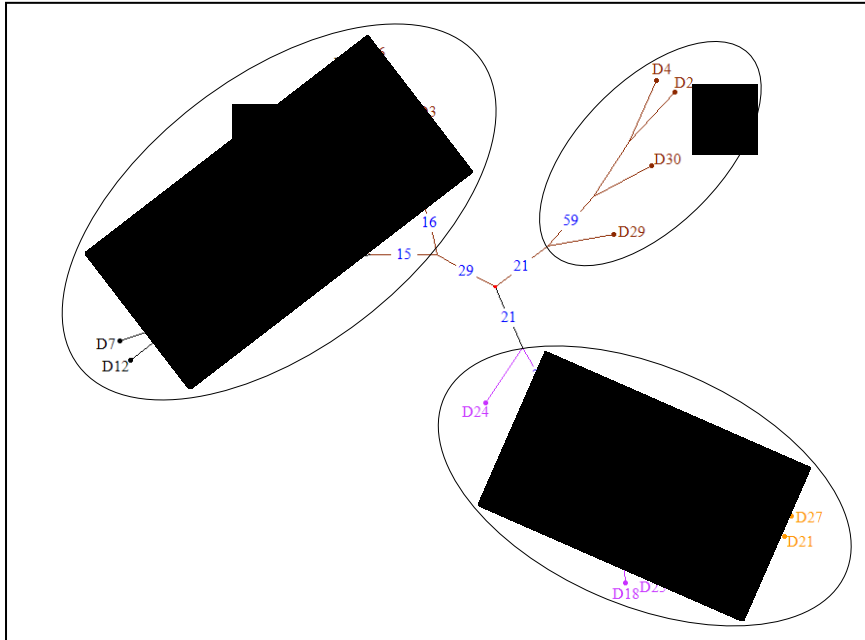

CONCLUSION

Palm oil DNA varieties D x P 54 NG that amplified with 3 RAPD primers (OPM-01, OPD-20, OPD-13) produce inequality distance from 20 samples ranged from 0 - 0.60 with molecular diversity of 54.31% and divided into 3 clusters.

Required a testing by using more primers to increase polymorphism so that higher and more accurate genetic diversity can be identified.

REFERENCES

- Badan Pusat Statistik. (2015). Indonesian Oil Palm Statistic. Jakarta. 100p
- Direktorat Jenderal Perkebunan. (2016). Statistik perkebunan Indonesia. Jakarta
- Alviodinasyari, R., A. Martina., W. Lestari. (2015). Pengendalian Ganoderma boninense oleh Trichoderma sp. SBJ8 pada Kecambah dan Bibit Kelapa Sawit (*Elaeis guineensis* Jacq.) di Tanah Gambut. JOM FMIPA, 2 (1).
- Puteri., D. Arifiyanto and I. Syahputra. (2018). Molecular performance of commercial MTG variety oil palm based on RAPD markers. IOP Conf. Series: Earth and Environmental Science 122 012078. IOP Publishing.
- Sohrabi, M., Rafii, M. Y., Hanafi, M.M. & Latif, M.A. (2013). Genetic divergence of Malaysian upland rice revealed by microsatellite markers". Plant Omic Journal, 6(3), 175-182.
- Indonesian Oil Palm Research Institute . 2017. Bahan Tanaman PPKS. <http://www.iopri.org/bahan-tanaman-ppks/>.
- Karsinah, Sudarsono, Setyobudi, L., & Aswidiionoor, H. (2002). Keanekaragaman genetik plasma nutfah jeruk berdasarkan analisis penanda RAPD. Jurnal Bioteknologi Pertanian, 7(1): 8-16.
- Yuniastuti, E. 2007. Analisis Fenotipik Dan Genotipik Pada Abnormalitas Klon-Klon Kelapa Sawit (*Elaeis guineensis* Jacq.) Hasil Kultur Jaringan. Caraka Tani XXII (1).
- Putri, L. A. P., Mahyuni. K. H., M. Basyuni, Indra, E. S. (2013). Analisis awal: Pemakaian marka molekuler RAPD untuk pendugaan Keragaman genetik nlasma Nutfah Aren Sumatera Utara. Fakultas Pertanian. Universitas Sumatera Utara. Medan.
- Poerba, Y. S. dan Yuzammi. (2008). Pendugaan keragaman genetik *Amorphollus titanium* Becc Berdasarkan Marka Random Amplified Polymorphic DNA. Bogor : Lembaga Ilmu Pengetahuan Indonesia.
- Oroczo-Castillo C, Chalmers K J, Waugh R, Powell W. (1994). Detection of genetic diversity and selective gene introgression in coffee using RAPD markers Theor. Appl. Genet. 87: 934-940.
- Toruan-Mathius N dan Hutabarat T 1997 Pemanfaatan teknik penanda molekuler dalam usaha meningkatkan produktivitas tanaman perkebunan Warta Puslit Biotek Perkebunan II (1):2-9.
- Asmono D, Toruan-Mathius N and Subronto. (2000). Pemetaan Genom Pengendali Produktivitas Minyak pada Kelapa Sawit Laporan Riset Unggulan Terpadu (RUT) VII Lembaga Ilmu Pengetahuan Indonesia.
- Perrier. X and Jacquemoud-Colled. J. P. (2016). DARwin Software. <http://darwin.cirad.fr/darwin>.
- Kularatne, R. S. (2001). Assessment of genetic diversity in natural oil palm (*Elaeis guineensis* Jacq.) using amplified fragment length polymorphism markers. (PhD thesis). Universiti Kebangsaan Malaysia, Bangi.
- Nagy S, Poczai P, Cernák I, Gorji AM, Hegedus G, Taller J (2012) PICcalc: an online program to calculate polymorphic information content for molecular genetic studies Biochem. Genet. 50 670–672.
- Maulan, Z., T. Kuswinan., N. R. Sennang dan S. A. Syarif. (2014). Eksplorasi Keragaman Plasma Nutfah Padi Lokal Asal Tanah Toraja Dan Enrekang Berdasarkan Karakterisasi Morfologi. Prosiding SEMNAS 2014. UNMAS Press. Denpasar. 347-352.
- Meryalita, R. (2012). Analisis Keragaman Genetik Kunyit (*Curcuma Longa* Linn) dan Temulawak (*Curcuma Xanthorrhiza* Roxb.) Budidaya Tanah Jawa Berdasarkan Penanda Molekuler RAPD. (Skripsi). Institut Pertanian Bogor. Bogor.

Morphological Response Of Some Brown Rice Varieties (*Oryza sativa* L.) Using PEG 6000 at Vegetative Phase

Siti Fadhilah

*Agrotechnology, Faculty of Agriculture
University of Sumatera Utara
Medan, Indonesia*

Eva Sartini Bayu

*Agrotechnology, Faculty of Agriculture
University of Sumatera Utara
Medan, Indonesia*

evagirsang61@gmail.com

Asni

*Biotechnology Laboratory, Faculty of Agriculture
University of Sumatera Utara
Medan, Indonesia*

Hot Setiadi

*Agrotechnology, Faculty of Agriculture
University of Sumatera Utara
Medan, Indonesia*

Abstract— *Rice is a food crop that generally planted in rainfed land that utilizes rainwater as its primary supplier so that testing of several drought-tolerant rice varieties is needed. The research examined the morphological response of brown rice to drought in the vegetative phase by treating the addition of Polyethylene Glycol (PEG) 6000 with a level of 20 g / l water. The research conducted at the Faculty of Agriculture's Greenhouse, University of Sumatera Utara, held in October 2018 until January 2019 using a randomized block design consisting of two factors with three replications. The results showed that the treatment of watering intervals of 14 days and 21 days on average plant height (75.14 - 67.71 cm), number of leaves (20.33 - 19.42 strands), number of tillers (4.11 - 3.67 tillers) and root volume (5.44 - 3.67 ml) were not significantly different compared to the control treatment, the highest average root length found in the watering interval of 21 days (29.13 cm). Of the several tested varieties obtained genotypes that were most resistant to drought stress based on their morphological responses were Inpago 7 varieties compared to Inpara 7 and Inpari 24 Gabusan varieties.*

Keywords— *rice, varieties, peg 6000, morphological response, drought stress*

INTRODUCTION

Rice (*Oryza sativa* L.) is a very important food crop and is considered a key product for financial and political stability that is planted in rainfed land that uses rainwater as a supplier of yields that are suitable for crop needs and drought tolerant. To overcome rice resistance to drought, the use of drought-resistant rice varieties is the easiest and cheapest way [1].

Research to obtain rice varieties that are relatively resistant to drought has been carried out by international institutions such as the International Rice Research Institute (IRRI) in the Philippines. Research in laboratories, greenhouses, and fields can improve drought stress strains or rice varieties. Identification of root characteristics with the use of root box, aeroponic systems, and root pulling power has been carried out at IRRI [2].

From the results of the collection and evaluation [3] identified that: asking for drought, early maturity, and high yield is an important character in brown rice which must be

repaired. Character improvement begins with a selection to determine the donor's parents and repeated elders. To fulfill the release requirements as new superior varieties, the genotype must be adapted and questioned in the environment [4].

A stable and highly yielding genotype is needed by farmers who have limited land to reduce income problems resulting from unpredictable changes in environmental factors [5].

The use of PEG for rice seed drought resistance tests was carried out at 2 and 12 bar water pressure levels, carried out at IRRI. PEG is an inner compound with widely used polymer chains for research. The regression model takes the form of a quadratic curve which is the relationship between air tension (bar) and the concentration level of the solution of PEG 1000, 4000, 6000, and 20,000 [5]. PEG 6000 was used in the study of the effect of air stress on rice growth. While [6] used PEG 6000 for seed priming research.

PEG 6000 is a polymeric compound from ethylene oxide that can be used to mimic the potential of groundwater or drought stress levels. The decrease in water potential depends on the concentration and weight of PEG molecules dissolved in water [6].

PEG is a compound that can reduce the osmotic potential of a solution through the activity of the ethylene oxide sub-unit matrix which can bind water molecules with hydrogen bonds. Because the osmotic potential of the solution decreases, the water present in the medium cannot be absorbed by plants so that the plant experiences osmosis which is characterized by the production of proline [7].

PEG 6000 solution cannot enter into plant tissue, so it is not toxic to plants. The advantages of these properties allow PEG 6000 to be used as an alternative method of plant tolerance selection for drought stress in the germination phase by providing PEG solutions on germination media such as in water, paper or on sand media [8].

This study aims to evaluate the morphological characteristics that can be used as indicators of tolerance to drought stress in the vegetative phase of brown rice (*Oryza sativa* L.).

There is an influence of the frequency of watering on the vegetative growth period of brown rice (*Oryza sativa* L.) Inpari 24 Gabusan (irrigated paddy) varieties, Inpara 7 (swamp rice) and Inpago 7 (upland rice) varieties in drought stress.

MATERIALS AND METHODS

This research was carried out in the Biotechnology laboratory and the Greenhouse of the Faculty of Agriculture, University of North Sumatra, with altitude + 25 meters above sea level. This research was conducted from November 2018 to January 2019.

Materials and Tools

The materials used in this study include chemical compounds PEG (Polyethylene glycol) 6000, filter paper, Clorox, sterile aquades, 3 types of certified brown rice varieties namely Inpara 7, Inpari 24 Gabusan and Inpago 7, topsoil, polybag 5 kg, 10kg sugar plastic, label paper, and NPK.

The tools used in this study include digital scales, 10 cm diameter petri dish, measuring cups, Erlenmeyer, hot plates, magnetic stirrers, hoes, hoops, hoses, meters, measuring cups and analytic scales.

Research Methods

The materials used in this study include chemical compounds PEG (Polyethylene glycol) 6000, filter paper, Clorox, sterile aquades, 3 types of certified brown rice varieties namely Inpara 7, Inpari 24 Gabusan and Inpago 7, topsoil, polybag 5 kg, 10kg sugar plastic, label paper, and NPK.

The tools used in this study include digital scales, 10 cm diameter petri dish, measuring cups, Erlenmeyer, hot plates, magnetic stirrers, hoes, hoops, hoses, meters, measuring cups and analytic scales.

Research methods

The research was compiled using a 2 factor randomized block design with 3 replications.

The first factor is the type of rice varieties, namely (P1) Inpara 7, (P2) Inpari24 Gabusan, (P3) Inpago 7. While the second factor is the watering frequency, which consists of 4 watering intervals, namely (K1) Control, (K2) 7 days interval, (K3) 14 days interval, (K4) 21 day interval. From the two experiments above, there were 12 combinations of treatments, namely:

The parameters observed from this treatment are: Plant height, The number of leaves, The number of tillers, Root length, and Root volume.

Conducting Research

In this study, each rice variety was germinated on germination media in a petri dish which had been given a solution of PEG 6000 with a dose of 20 g /l. Germination test using a closed petri dish substratum method. Petri dishes used with a size of 10 cm in diameter, the inside is given a layer with filter paper as many as 1 layer. The treated rice seeds are placed on top of 20 pieces, then the petri dish is covered with a lid and the same treatment is added in each petri dish according to treatment every 2 days to compensate for water lost through evaporation. Rice plants that have been added to petri dish for 7 days using PEG 6000 with a dose of 20 g /l planted in a medium-capacity planting medium with a planting media weight of 3.08 kg/polybag with watering 0.93 liters/polybag,

soil pH 6.03 and fertilization is given 3 times, namely when planting with NPK 5 g / polybag with a ratio (15:15:15) given when the plant is 21 days old with the addition of urea as much as 1 g /polybag and finally at the primordial flower phase with the addition of urea 1 g/polybag.

RESULT

On observation of 1 MSPT and 2 MSPT, the treatment of varieties was significantly different from plant height. In observation 4 MST the treatment of varieties showed a significant difference as well as the frequency of watering which showed a significant effect on plant height. In observations 5, 6 and 7 the MSPT watering frequency treatment showed a significant effect on plant height. In the observation of 8 MSPT, the treatment of varieties showed significant differences and the frequency of watering had a significant effect on plant height. In observations 3, 4, 5 and 7 MSPT the treatment of watering frequency significantly affected the number of leaves. In observations 6 and 8 MSPT treatment of varieties showed significant differences, as well as the frequency of watering, which showed a significant effect on the number of leaves. In observations 3, 4, 5, 6, 7 and 8 MSPT the watering frequency treatment had a significant effect on the number of tillers. At the root length observation, not that treatment that showed a difference or a real influence. In observing the root volume of varieties treatment showed significant differences and the frequency of watering the real effect and the interaction between varieties with watering frequency showed significant differences. To be more clear about the results of each parameter can be seen in the following paragraph

Plant Height

Observation data on plant height and variance can be seen in Appendix 11-26. The results of variance analysis showed that the treatment of varieties was significantly different and the frequency of watering had a significant effect on plant height, while the interaction between varieties and frequency of plant watering was not significantly different. The average plant height of 1-8 MSPT can be seen in Table 1 and a graph of the growth of brown rice height can be seen in Fig. 1-2.

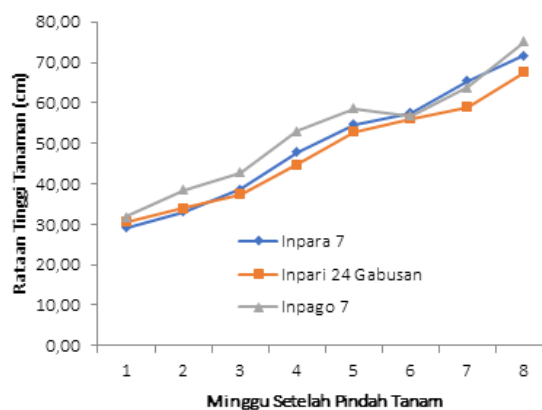

Graph of the average height of red rice rice 1-8 MSPT in the variety treatment

DWIKASTA AVERAGE HEIGHT OF RED RICE RICE 1-8 MSPT

MSPT	Rice Varieties	Watering frequency				Average
		K1	K2	K3	K4	
.....cm.....						
1	Inpari 7	30,57	26,03	30,37	29,43	29.10 b
	Inpari 24	31,47	29,70	29,23	31,67	30.52 ab
	Inpago 7	29,90	32,20	34,17	31,10	31.84 a
	Rataan	30,64	29,31	31,26	30,73	
2	Inpari 7	34,57	32,43	32,87	32,33	33.05 b
	Inpari 24	35,37	32,83	33,57	33,90	33.92 b
	Inpago 7	39,73	38,93	39,17	36,17	38.50 a
	Rataan	36,56	34,73	35,20	34,13	
3	Inpari 7	44,83	39,05	35,00	35,75	38.66
	Inpari 24	42,03	35,40	36,20	36,37	37.50
	Inpago 7	46,80	43,80	41,30	39,40	42.83
	Rataan	44,56	39,42	37,50	37,17	
4	Inpari 7	57,37	49,37	43,20	41,17	47.78 ab
	Inpari 24	54,73	43,97	41,87	38,90	44.87 b
	Inpago 7	61.67	57.73	51.20	45.70	53.08 a
	Rataan	57,92	49,02	45,42	41,92	
5	Inpari 7	64,93	57,47	43,97	52,63	54.75
	Inpari 24	61,73	53,90	41,00	54,57	52.80
	Inpago 7	66,90	59,20	50,77	57,57	58.61
	Rataan	64.52	56.86	45.24	54.92	
6	Inpari 7	71,33	58,83	45,67	54,67	57.63
	Inpari 24	66,00	56,83	43,00	58,67	56.13
	Inpago 7	70,67	60,33	37,00	59,50	56.88
	Rataan	69.33	58.67	41.89	57.61	
7	Inpari 7	72,27	65,97	60,37	63,33	65.48
	Inpari 24	66,60	60,87	49,37	58,90	58.93
	Inpago 7	71,30	64,50	55,77	64,10	63.92
	Rataan	70.06	63.78	55.17	62.11	
8	Inpari 7	78,17	72,50	66,50	69,57	71.68 ab
	Inpari 24	74,93	67,97	60,80	66,73	67.71 b
	Inpago 7	81,03	80,57	62,33	76,63	75.14 a
	Rataan	78.04	73.68	63.21	70.98	

In Figure 1 the plant height at 1 MSPT shows that the treatment of varieties of P3 (31.84cm) was significantly different from P2 (30.52cm) and P3 (29.10 cm). Plant height at 2 MSPT showed that the treatment of P3 varieties (38.50 cm) plant height was significantly different from P2 (33.92 cm) and P3 (29.10 cm). Plant height in 3 MSPT varieties was not significantly different. Plant height at 4 MSPT showed that the treatment of varieties P3 (53.08 cm) was significantly different from P2 (47.78 cm) and P3 (44.87 cm). Plant height at 5, 6 and 7 MSPT varieties were not significantly different. Plant height at 8 MSPT showed that the treatment of varieties P1 (71.68 cm) was significantly different from P2 (67.71 cm) and P3 (75.14

cm).

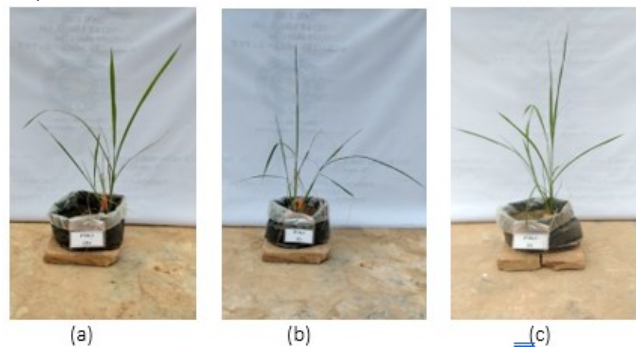
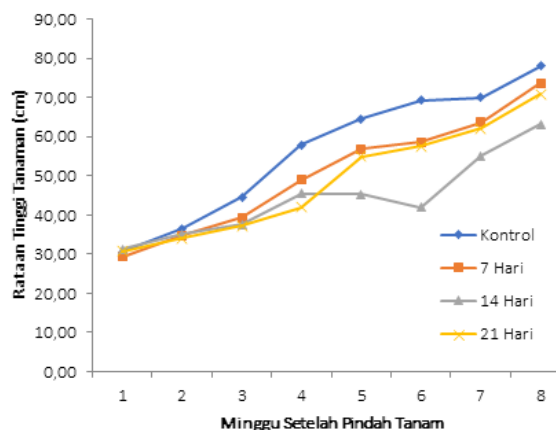

Figure 3. Appearance of brown rice rice height at 8 MSPT(a) Inpari 24 Gabusan (b) Inpara 7 (c) Inpago 7

In Figure 3 plant height at 1, 2 and 3 MSPT shows that the watering frequency treatment has no significant effect. At 4 MSPT it was seen that the treatment of K1 (57.92cm) watering frequency was significantly different from K2 (49.02cm), K3 (45.42cm) and K4 (41.92cm). At 5 MSPT it was seen that the treatment of the frequency of watering K1 (64.52 cm) was significantly different from K2 (56.86cm), K3 (45.24cm) and K4 (54.92cm). At 6 MSPT showed that the treatment of K1 (69.33cm) watering frequency was significantly different from K2 (58.67cm), K3 (41.89cm) and K4 (57.61cm). At 7 MSPT showed that the treatment of K1 (70.06cm) watering frequency was significantly different from K2 (63.78cm), K3 (55.17cm) and K4 (62.11cm). At 8 MSPT showed that the treatment of K1 (78.04cm) watering frequency was significantly different from K2 (73.68cm), K3 (63.21cm) and K4 (70.98cm). The appearance of brown rice can be seen in Fig. 2.



Graph of the average height of red rice rice 1-8 MSPT in the watering frequency treatment

DWIKASTA AVERAGE NUMBER OF BROWN RICE TILLERS 3-8 MSPT

MSP T	Varietas Padi	Frekuensi penyiraman				Rataan
		K1 (Kontrol)	K2 (7 Hari)	K3 (14 Hari)	K4 (21 Hari)	
3	Inpara 7	1,00	0,67	0,00	0,33	0,50
	Inpari 24	0,67	0,33	0,67	0,00	0,42
	Inpago 7	1,00	0,33	0,00	0,00	0,33
	Rataan	0,89 a	0,44 ab	0,22 b	0,11 b	
4	Inpara 7	3,67	3,00	1,33	1,33	2,33
	Inpari 24	3,00	1,33	2,00	1,33	1,92
	Inpago 7	3,67	1,33	0,33	1,00	1,58
	Rataan	3,44 a	1,89 b	1,22 b	1,22 b	
5	Inpara 7	4,67	3,00	1,33	1,67	2,67
	Inpari 24	3,00	3,33	1,67	2,33	2,58
	Inpago 7	4,00	1,00	0,33	1,33	1,67
	Rataan	3,89 a	2,44 b	1,11 c	1,78 bc	
6	Inpara 7	7,67	5,00	3,00	2,67	4,58
	Inpari 24	6,00	3,00	1,67	2,33	3,25
	Inpago 7	5,67	2,67	1,67	3,33	3,33
	Rataan	6,44 a	3,56 ab	2,11 b	2,78 b	
7	Inpara 7	8,00	6,33	3,67	3,33	5,33
	Inpari 24	6,33	4,67	3,33	3,00	4,33
	Inpago 7	7,00	3,67	2,67	4,67	4,50
	Rataan	7,11 a	4,89 b	3,22 b	3,67 b	
8	Inpara 7	8,33	7,67	5,00	4,33	6,33
	Inpari 24	10,00	5,00	3,33	3,33	5,42
	Inpago 7	9,00	5,00	2,67	4,67	5,33
	Rataan	9,11 a	5,89 b	3,67 c	4,11 bc	

Number of Leaves

Observation data on the number of leaves and variance can be seen in Annex 27-48. The results of variance analysis showed that at 3, 4 and 5 MSPT the treatment of watering frequency had a significant effect on the number of leaves. In the observation of 6 MSPT, the treatment of varieties showed significantly different as well as the frequency of watering which showed a significant effect on the number of leaves. In the observation of 7 MSPT, the treatment of watering frequency significantly affected the number of leaves. In the observation of 8 MSPT, the treatment of varieties showed significantly different as well as the frequency of watering which showed a significant effect on the number of leaves. The average number of leaves 1-8 MSPT can be seen in Table 2.

Table 2 shows that in the 3 MSPT treatments, the frequency of watering K1 (7.11cm) was significantly different from K2 (6.22cm), K3 (5.33cm) and K4 (4.67cm). In 4 MSPT treatments the frequency of watering K1 (12.89) was not significantly different from the treatment of K2 (9.78) but was significantly different from the treatment of K3 (7.89) and K4 (8.44). At 5 MSPT it was seen that the treatment of K1 (16.89)

watering frequency was significantly different from K2 (12.56), K3 (7.22) and K4 (12.00). At 6 MSPT, it was seen that the treatment of the Inpara 7 variety (18.42) was significantly different from the Inpari 24 Gabusan (13.42) and Inpago 7 (11.67) and the watering frequency K1 (22.89) treatment was significantly different from K2 (13, 67), K3 (9,22) and K4 (12,22). At 7 MSPT it was seen that the treatment frequency of watering K1 (25.67) was significantly different from K2 (16.78), K3 (12.33) and K4 (15.33). In 8 MSPT, it was seen that the treatment of the Inpara 7 variety (27.58) was significantly different from Gabusan Inpari 24 (20.33) and 7 Inpari (19.42) and the K1 (32.22) watering frequency treatment was significantly different from K2 (23, 78), K3 (15.78) and K4 (18.00).

Number of Tiller

Observation data on the number of tillers and variance can be seen in Annex 49-72. The results of variance analysis showed that the watering frequency treatment had a significant effect on the number of tillers, while the variety treatment and interaction between varieties and watering frequency were not significantly different from the number of tillers. The average number of tillers 3-8 MSPT can be seen in Table 3.

Table 3 shows that in the 3 MSPT treatments the frequency of watering the control treatment K1 (0.89) was significantly different from K3 (0.22) and K4 (0.11) but not significantly different from K2 (0.44). At 4 MSPT it was seen that the treatment of K1 (3.44) watering frequency was significantly different from K2 (1.89), K3 (1.22) and K4 (1.22). At 5 MSPT it was seen that the treatment of K1 (3.89) watering frequency was significantly different from K2 (2.44), K3 (1.11) and K4 (1.78). At 6 MSPT it was seen that the treatment of the frequency of watering K1 (6.44) was not significantly different from K2 (3.56), but was significantly different from K3 (2.11) and K4 (2.78). At 7 MSPT it was seen that the treatment frequency of watering K1 (7.11) was significantly different from K2 (4.89), K3 (3.22) and K4 (3.67). At 8 MSPT it was seen that the treatment of watering frequency K1 (9.11) was significantly different from K2 (5.89), K3 (3.67) and K4 (4.11).

Root Length

Root length and variance observation data can be seen in Annex 73-74. The results of variance were obtained that the treatment of varieties, frequency of watering and the interaction of both did not significantly affect root length which can be seen in Table 4.

Table 4 shows that the variety treatment, the frequency of watering and the interaction of the two did not significantly influence the length of the roots of the brown rice at 8 MSPT. The highest treatment of root length varieties was found in Inpara 7 treatment with an average of 28.14 cm and the lowest Inpago 7 with an average of 26.07 cm. In the frequency treatment, the highest watering of root length was found in K4 treatment with an average of 29.13 cm and the lowest was in K3 treatment which was 23.86 cm.

DWIKASTA AVERAGE ROOT LENGTH (K1=CONTROL, K2=7 DAYS, K3=14 DAYS, AND K4=21 DAYS)

Varietas Padi	Frekuensi penyiraman				Rataan
	K1	K2	K3	K4	
cm.....				
Inpara 7	25,60	32,00	24,17	30,80	28,14
Inpari 24	29,97	26,10	20,40	30,30	26,69
Inpago 7	26,97	24,00	27,00	26,30	26,07
Rataan	27,51	27,37	23,86	29,13	

The appearance of the roots of each variety in the watering frequency treatment is shown in Fig. 4.

Root Volume

Observation data on root volume and variance can be seen in Annex 75-76. The results of an analysis of variance obtained that the treatment of varieties was significantly different and the frequency of watering treatment had a significant effect, as well as the interaction between varieties and frequency of watering significantly different from root volume, can be seen in Table 5. The appearance of the root volume of each variety can be seen in Fig 4.

Table 5 shows that the treatment of varieties of Inpara 7 (14.50 ml) was significantly different from Inpari 24 Gabusan (7.83 ml) and Inpago 7 (7.75 ml). The control treatment (21.44 ml) was significantly different from the frequency of 7 days.

DWIKASTA AVERAGE NUMBER OF BROWN RICE TILLERS 3-8 MSPT

MSPT	Varietas Padi	Frekuensi penyiraman				Rataan
		K1 (Kontrol)	K2 (7 Hari)	K3 (14 Hari)	K4 (21 Hari)	
	anakan.....				
3	Inpara 7	1,00	0,67	0,00	0,33	0,50
	Inpari 24	0,67	0,33	0,67	0,00	0,42
	Inpago 7	1,00	0,33	0,00	0,00	0,33
	Rataan	0.89 a	0.44 ab	0.22 b	0.11 b	
4	Inpara 7	3,67	3,00	1,33	1,33	2,33
	Inpari 24	3,00	1,33	2,00	1,33	1,92
	Inpago 7	3,67	1,33	0,33	1,00	1,58
	Rataan	3.44 a	1.89 b	1.22 b	1.22 b	
5	Inpara 7	4,67	3,00	1,33	1,67	2,67
	Inpari 24	3,00	3,33	1,67	2,33	2,58
	Inpago 7	4,00	1,00	0,33	1,33	1,67
	Rataan	3.89 a	2.44 b	1.11 c	1.78 bc	
6	Inpara 7	7,67	5,00	3,00	2,67	4,58
	Inpari 24	6,00	3,00	1,67	2,33	3,25
	Inpago 7	5,67	2,67	1,67	3,33	3,33
	Rataan	6.44 a	3.56 ab	2.11 b	2.78 b	
7	Inpara 7	8,00	6,33	3,67	3,33	5,33
	Inpari 24	6,33	4,67	3,33	3,00	4,33
	Inpago 7	7,00	3,67	2,67	4,67	4,50
	Rataan	7.11 a	4.89 b	3.22 b	3.67 b	
8	Inpara 7	8,33	7,67	5,00	4,33	6,33
	Inpari 24	10,00	5,00	3,33	3,33	5,42
	Inpago 7	9,00	5,00	2,67	4,67	5,33
	Rataan	9.11 a	5.89 b	3.67 c	4.11 bc	

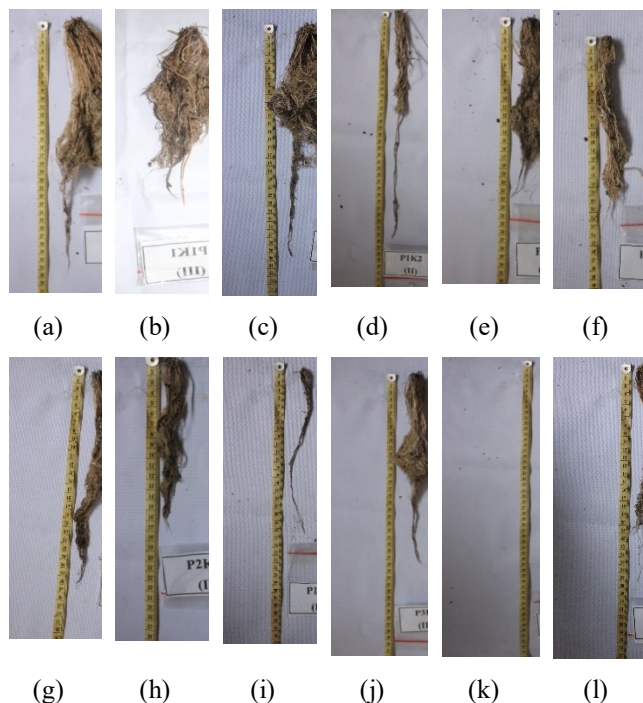

Brown rice paddy root in the treatment (a) Control treatment of Inpara 24 Gabusan (b) Control treatment of Inpara 7 (c) Control treatment of Inpago 7 (d) Inpara 24 Gabusan with 7 days of watering intervals (e) Inpara 7 with 7 days of watering intervals (f) Inpari 7 Gabusan with 7 days of watering intervals (g) Inpago 7 with 14 days of watering intervals (h) Inpari 24 Gabusan with 14 days of watering intervals (i) Inpara 7 with 14 days of watering intervals (j) Inpago 7 with 21 days of watering intervals (k) Inpara 7 with 21 days of watering intervals (l) Inpari 24 Gabusan with 21 days of watering intervals (9.56 ml), 14 days (3.67 ml) and 21 days (5.44 ml). The treatment of the watering frequency of 14 days (3.67 ml) was not significantly different from the frequency of watering 21 days (5.44 ml). In the interaction between varieties and the frequency of watering the treatment Inpara 7 in the control had the highest average root volume (38.00 ml) which was significantly different from the other treatments. Inpari 24 treatment at 14 days watering had the lowest root volume average which was significantly different from Inpara 7, Inpari 24 and Inpago 7 varieties in control, Inpara 7, Inpari 24 and Inpago 7 at 7 days watering frequency, and Inpara 7, Inpago 7 at frequency watering 21 days.

DWIKASTA ROOT VOLUME AVERAGE (K1=CONTROL, K2=7 DAYS, K3=14 DAYS, AND K4=21 DAYS)

Varietas Padi	Frekuensi penyiraman				Rataan
	K1	K2	K3	K4	
ml.....				
Inpara 7	38,00a	10,67b	3,67e	5,67d	14,50a
Inpari 24	13,67b	9,67b	3,33e	4,67de	7,83b
Inpago 7	12,67b	8,33bcd	4,00e	6,00d	7,75b
Rataan	21,44a	9,56b	3,67c	5,44c	

The appearance of the roots of each variety in the watering frequency treatment is presented in fig. 5.

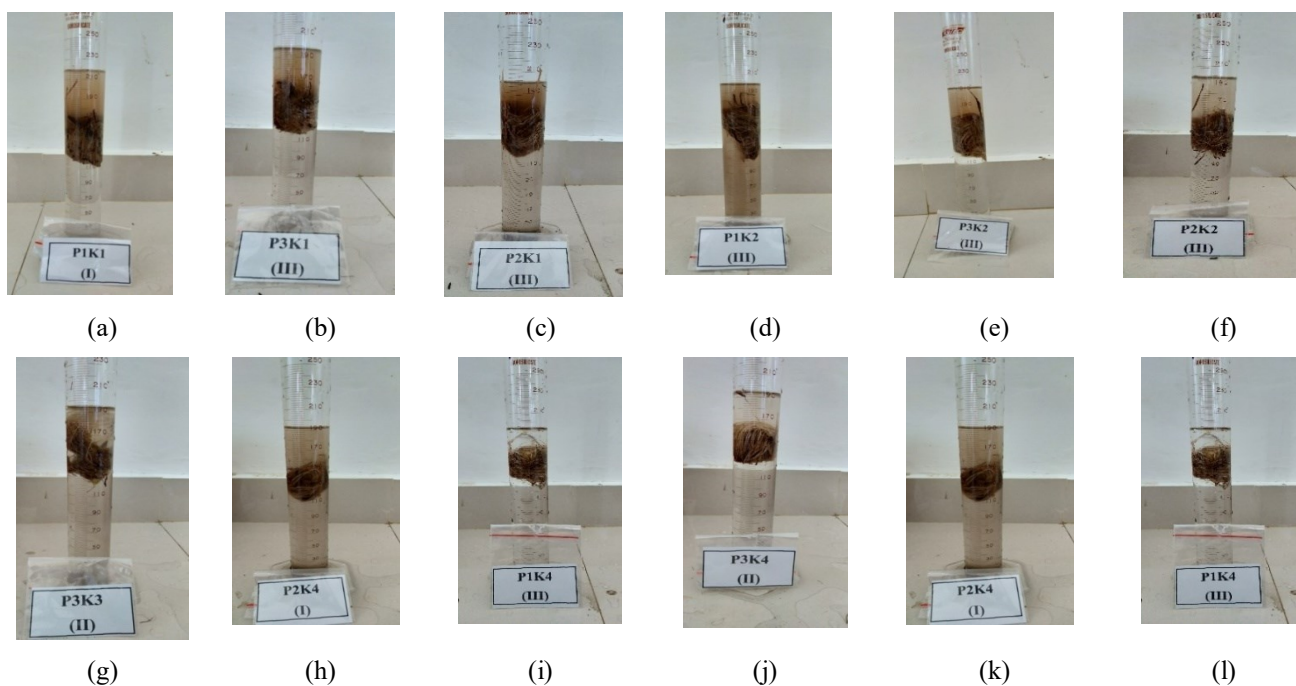

DISCUSSION

The results of the research on the morphology of brown rice in greenhouses on observations of plant height showed a difference in response of plant height from each variety based on the treatment of varieties and the frequency of water given. Inpago 7 varieties have the highest average plant height compared to other varieties. While the Inpari 24 Gabusan variety has the lowest average plant height compared to other varieties. This shows that drought stress causes a high growth of red rice genotypes. This is following the opinion of [9] which states that plant height growth begins with the process of cell division and enlargement where both processes are influenced by water availability. The process of cell division and enlargement will occur if the cell experiences turgidity, the main element being water.

In observing the number of leaves, it was seen that the average number of leaves of the 3 MSPTs showed a greater number of leaf trends in the control treatment compared to other watering treatments. It is suspected that drought stress causes a decrease in the number of leaves of each genotype of brown rice. Drought stress inhibits shoot growth as indicated by a decreased shoot height increase, the number of main roots, and the number of leaves.

In observing the number of tillers, it was seen that the Inpara 7 variety had the highest number of tillers compared to other varieties. Whereas Inpago 7 and Inpari 24 Gabusan have the least number of tillers. This is thought to be one of the ways to adapt Inpago 7 and Inpari 24 varieties of Gabusan to drought stress conditions because plants that live in drought areas will try to make efficient use of water by reducing the number of tillers so that it will reduce transpiration. This is following the opinion of [10] which states that rice plants that have a low number of tillers with a low rate of decline are also the adaptability of plants to drought stress conditions.

At the root length observations, it was seen that the growth of the length of the Inpari 24 Gabusan variety of brown rice in the drought conditions had the longest root average, while the

Inpara 7 variety had the shortest root average compared to the other varieties. This is presumably due to the characteristics of the Inpara 7 variety which is usually planted in the swamp and tidal land which provides optimal water needs so that the

Brown rice paddy root in the treatment (a) Control treatment of Inpara 7 (b) Control treatment of Inpago 7 (c) Control treatment of Inpari 24 Gabusan (d) Inpago 7 with 7 days of watering intervals (e) Inpari 24 Gabusan with 7 days of watering intervals (f) Inpara 7 with 7 days of watering intervals (g) Inpago 7 with 14 days of watering intervals (h) Inpari 24 Gabusan with 14 days of watering intervals (i) Inpara 7 with 14 days of watering intervals (j) Inpago 7 with 21 days of watering intervals (k) Inpari 24 Gabusan with 21 days of watering intervals (l) Inpara 7 with 21 days of watering intervals. Inpara 7 variety is not able to adapt to drought conditions. This is following the opinion of [11] which states that varieties that have a mechanism for the resistance of plant genotypes to drought will have an increasing root length.

In this study, it was known that the treatment of varieties and the frequency of watering did not affect the length of the roots, even though the roots of a plant served to provide nutrients and water for plant metabolism. It is suspected that this happened because this research was carried out on polybags with limited media and non-homogeneous environmental conditions, so that even though plants could develop resistance to drought stress by root extension but did not occur significantly due to limited planting media. This is following the opinion of [9] which states that limited media will cause growth and root extension that are not significant. Whereas [12] state that plants that grow in drought stress conditions will form a greater number of roots with lower yields.

In the observation of root volume, it was seen that the Inpara 7 variety in the control treatment had the highest root volume compared to other varieties, but the Inpara 7 variety after being given the watering frequency treatment drastically decreased the root volume. This shows that the watering

frequency treatment has a significant effect on the volume of roots of brown rice. But the longer the plants experience drought stress causing a decrease in root volume average, plants with a frequency of watering 14 days have the lowest average root volume compared to other treatments, average root volume and the highest on control or watering treatment every day. So it is suspected that drought stress causes a decrease in the root volume of each genotype of brown rice. This is following the opinion of [13] which states that the criteria for the resistance of several rice varieties to drought can be seen from the root characteristics possessed, including the root volume.

CONCLUSION

1. The frequency of watering has a significant effect on plant height, number of leaves, number of tillers and root volume in the vegetative phase of brown rice in Inpara 7 varieties, Inpari 24 Gabusan and Inpago 7.
2. The brown rice varieties tested by the watering frequency treatment have different growths in the vegetative phase. Inpago 7 varieties had the highest average in plant height (75.14 cm) and root length (42.29 cm). Inpara 7 varieties produced the highest average number of leaves (27.58 strands), number of tillers (6.33 tillers), root length (28.14 cm) and root volume (14.50 ml).

Further research is needed with a level of PEG 6000 that is different from the tested level and the thickness of the wax layer which is lower than 3 mm and the frequency of watering that is different from the frequency tested.

REFERENCES

- Purnamaningsih, R. 2006. Induksi Kalus dan Optimasi Regenerasi Empat Varietas Padi melalui Kultur In Vitro. *Jurnal AgroBiogen* 2 (2): 74-80.
- Lestari, E.G dan I. Mariska, 2006. Identifikasi Somaklon Padi Gajah mungkur, Towuti dan IR64 Tahan Kekeringan Menggunakan Polyethylene Glycol. *Buletin Agroteknologi*. (34)(2): 71 – 78.
- Sumarjan. 2001. Klasifikasi padi lokal (*Oryza sativa*. L.) di Lombok berdasarkan sifat dan ciri morfologi-anatomi. Thesis. Program PascaSarjana Universitas Gajah Mada. Yogyakarta.
- Muliarta, N., Kantun, Sanisah, N. Soemenaboedhy. 2005. Upaya Mendapatkan Padi Beras Merah Tahan Kekeringan Melalui Metode Seleksi “Back Cross”. Penelitian Hibah Bersaing XI/3 (not published).
- Steuter, A.A. 1981. Water potential of aqueous polyethylene glycol. *Plant Physiol*. 67:64-67.
- Hardegree SP, W. E Emmerich. 1992. Seed Germination Responce Of Four Southwestern Range Grasses To Equilibration At Subgermination Matrix-Potentials. *Agron. J*. 84: 994 – 998.
- Tuasamu, Y. 2009. Toleransi hotong (*Setaria italic* l. Beauv) pada berbagai cekaman kekeringan: pendekatan anatomi dan fisiologi. Tesis. Sekolah Pascasarjana. Institut Pertanian Bogor. Bogor.
- Balch EPM, Gidekel M, Nieto MS, Estrella LH, Alejo NO. 1996. Effects of water stress on plant growth and root proteins in three cultivars of rice (*Oryza sativa*) with different levels of drought tolerance. *Plant Physiol* 96:284-290.
- Santoso, 2008. Kajian Morfologis dan Fisiologis Beberapa Varietas Padi Gogo (*Oryza Sativa* L.) Terhadap Cekaman Kekeringan. Skripsi. Fakultas Pertanian Universitas Sebelas Maret. Surakarta.
- Matsuo, T.Y. and K. Hoshikawa. 1993. Science of the Rice Plant. Vol. 1 : Morphology, Ford and Agricultural Policy Research Center. Tokyo. 686 p.
- Mackill, D.J., W.R. Coffman, and D.P. Garrity. 1996. Rainfed Lowland Rice Improvement. IRRI, Manila. p. 242.
- Sitompul, M. dan B. Guritno. 1995. Analisis Pertumbuhan Tanaman. GadjahMada University Press. Yogyakarta.
- Sudarmawan, A. 2010. Analisis Rerata Generasi Hasil Persilangan Dua Varietas Padi Tahan terhadap Cekaman Kekeringan. *Journal Crop. Agro*. 3(1):72-75.

Profile of Oil Palm (*Elaeis Guineensis* Jacq.) DNA Band DXP 540 NG Variety Based on RAPD (Random Amplified Polimorphism DNA) Marker

Rumata Yohana Diantoro
Agrotechnology, Faculty of Agriculture
University of Sumatera Utara
Medan, Indonesia

Lollie Agustina P. Putri
Agrotechnology, Faculty of Agriculture
University of Sumatera Utara
Medan, Indonesia

Eva Sartini Bayu
Agrotechnology, Faculty of Agriculture
University of Sumatera Utara
Medan, Indonesia

evagirsang61@gmail.com

Diana Sofia Hanafiah
Agrotechnology, Faculty of Agriculture
University of Sumatera Utara
Medan, Indonesia

Asni
Biotechnology Laboratory, Faculty of
Agriculture
University of Sumatera Utara
Medan, Indonesia

Abstract— *RAPD marker is an informative molecular marker, could enhance the efficiency of early selection stage and reduce selection time in oil palm breeding. The aim of this study was to look at the percentage of polymorphic bands of genetic diversity in the DXP 540 NG Variety based on three random amplified polimorphism DNA marker. This study was conducted in Laboratory Plant Biotechnology Faculty of Agriculture, Universitas Sumatera Utara, Medan. A total of 20 oil palm leaf samples of the DXP 540 NG variety were isolated. The absorbance values of DNA stocks at A260 / 280 ranged from 1.37-2.50. The size of the bands ranged from 446-1574 bp measured using UVITEC Cambridge FireReader software. The DNA concentration ($\mu\text{g} / \text{ml}$) ranged from 95.1-1036. The total banding pattern produced 14 bands with 100% polymorphic bands.*

Keywords— *oil palm, polymorphism, RAPD*

I. INTRODUCTION

Oil palm plants are one type of plantation that occupies an important position in the agricultural sector in general, and in particular the plantation sector. This is because of the many plants that produce oil or fat, oil palm produces the largest economic value per hectare in the world [1].

The main products of palm oil consist of crude palm oil (CPO) and kernel palm oil (KPO) which have high economic value. Palm oil also produces various derivative products that are rich in benefits so that they can be used in various industries, from the food industry, pharmaceuticals to cosmetics. Thus oil palm is one of the biggest contributors to foreign exchange compared to other plantation commodities.

Since 2009 the Palm Oil Research Center (PPKS) has conducted a series of studies. Based on the results of field observations on germplasm collection and progenic testing, genetic material belonging to the PPKS has been identified that have resistance to *Ganoderma*. which is a descendant of the SP540T. The crossing which showed resistance properties was then determined as a moderate variety resistant to *Ganoderma* and named DXP 540 NG. NG means New Generation for *Ganoderma*.

Genetic diversity is an important factor in maintaining the existence of a species. A population with high genetic

diversity, has the ability to defend itself from attacks by disease and extreme climate change, so that it is able to live in sustainable conditions for several generations [2].

Genetic diversity can occur due to changes in the nucleotides that make up DNA. This change can affect the phenotype of an organism that can be seen directly or affect the individual's reaction to a particular environment [3].

The level of polymorphism obtained from the analysis of molecular markers is very important information for plant breeders to be a reference to see the richness of gene diversity [4].

Molecular markers are an excellent tool for breeders and geneticists to analyze plant genomes. This system has revolutionized the field of genetic mapping and can be used to answer questions relating to genetic diversity, classification and phylogeny in germplasm management, and as a tool in breeding and selection through gene marking [5].

Molecular markers help a lot in various fields, such as evaluating plant biodiversity, microbes and animals, identifying species (taxonomy) of plants and microbes and exploring molecular markers that play a role in plant resistance to markers or marker aided selection and in mapping genomes . Various molecular techniques that have been developed include RFLP (Restriction Fragment Length Polymorphism), AP-PCR (Arbitrary Primed PCR), DAF (DNA Amplified Fingerprinting), RAPD (Random Amplified Polymorphic DNA), AFLP (Amplification Fragment Length Polymorphism) and STMS (Sequence Tagged Microsatellites), each of which has advantages and disadvantages. Therefore, a combination of several techniques will provide more comprehensive and accurate data [6].

RAPD (Random Amplification Polymorphic DNA) is one of the molecular marking techniques. This technique is also used to identify genotypes in plant taxonomy studies and can see the genetic differences of each individual. RAPD markers are widely used because of the low cost, and the process is easy and fast when compared to other markers [7].

RAPD markers are informative molecular markers, can be used to detect polymorphisms among commercial MTG palm

oil germplasm access and are able to classify the genetic background of MTG oil palm varieties and are an important tool for genetic analysis of these major oil palm germplasm [8].

The RAPD method itself involves the use of DNA polymerization (PCR) techniques. PCR is an in vitro method for producing a large number of specific DNA fragments of length and predetermined sequences from a small number of complex templates. PCR is a very powerful and sensitive technique that can be applied in various fields such as molecular biology, diagnostics, population genetics and forensic analysis [9].

In this study to improve efficiency at the initial stage of selection and shorten the time needed for oil palm plant breeding program DxP 540 NG variety was carried out by molecular marker-based selection, namely Random Amplified Polymorphic DNA (RAPD) markers [10].

V. MATERIALS AND METHODS

This research was carried out at the Agriculture Biotechnology Laboratory, Faculty of Agriculture, Universitas Sumatra Utara, Medan, which began from May to December 2018. The materials used were 20 samples of DxP 540 NG oil palm leaves issued by the Palm Oil Research Center, Medan.

The chemicals used are Polyvinylpolypyrrolidone (PVPP), liquid nitrogen, extraction buffer, cetyl trimethylammonium bromide (CTAB), CTAB extraction buffer (2 gr NaCl, 5 g CTAB, 100 ml aquades), TAE buffer, buffer TE, KIAA (24 ml chlorophome: 1ml isoamil-alcohol) Hcl pa, NaOH, Na-EDTA, cold isopropanol, ethylenediamine tetraacetic (EDTA), β -mercaptoethanol 2%, ethanol 70%, absolute ethanol, 100 bp Ladder DNA marker, Go taq Green Master Mix, loading dye, aquades, aquabidest, agarose, tissue paper, rubber gloves, aluminum foil, and primer OPA-13, OPN-03, OPB-07.

The tools used in this research are mortar, pestle, micropipette size 1-10 μ l, 20-100 μ l, 100-1000 μ l, pipette tip (white, yellow and blue) tube rack, autoclave, waterbath, magnetic stirrer, centrifuge, freezer, computers, electric scales, vortex, agarose molds, 2ml and 1.5ml eppendorf tubes, chambell well (like electrophoresis), power supply, PCR (Therma Cycler) UV Transilluminator, Gel-Doc (Cambridge UV), pH meter, tool - glassware (beaker glass, erlenmeyer, etc.) power supply, stationery, stirrer, camera, oven, scissors, tweezers, spatulas, digital scales.

A. Research Methods

The research method used is the molecular marking method using 3 RAPD primers based on PCR (Polymerase Chain Reaction) which amplifies specific DNA sequences, and is processed with DARwin 6.0 software.

B. Isolation and DNA Purification

DNA isolation using [11] using β -mercaptoethanol dan Polyvinyl-Polypyrrolidone (PVPP) during extraction. The quality test was carried out by 0,8 % agarose gel electrophoresis, and the quantity test was measured using uv spectrophotometry. Absorbance was measured at wavelengths of 260 nm and 280 nm. DNA purity was determined from a comparison value of A260/A280, where a pure DNA sample would produce a ratio of A260/A280 ranging from 1,8 to 2,0. In this study 20 stocks of DNA were obtained

C. Amplification and Selection of RAPD markers

Amplification was carried using 3 RAPD primers (OPA-13, OPB-07, OPN-03). Before running PCR, DNA dilution was carried out with ddH₂O. PCR amplification process can be seen in table 1.

CYCLE, PROCESS, TEMPERATURE AND TIME OF LEAF PALM DNA AMPLIFICATION.

No.	Stages	Temperature	Time (Minute)	Number of Cycles
1	Early Denaturation	94° C	2	1
2	Denaturation	94° C	1	45
3	Annealing	36° C	1	45
4	Extention	72° C	1	45
5	Final Extention	72° C	10	1

Source : Setyo, 2001.

After the PCR reaction was finished, the amplified DNA was stored at a temperature of -20°C when not in use.

D. Electrophoresis

A 1,3% agarose gel was prepared and then dissolved by adding 80 ml of 1x TAE buffer. The solution was put into erlenmeyer, then heated and stirred with a magnetic stirrer until the solution became clear. After that added 1 μ l etidium bromide, after the solution cooled (temperature \pm 60° C) then the solution was printed into molds that had been installed in the hole making comb and left to solidify for \pm 45 minutes or until the gel hardened. The amplification was interested into the well, and connected to an electric current, then electrophoresis process was ready to run. Running electrophoresis was carried out at 46 volt for 120 minutes. After electrophoresis running was finished, the electric current was turned off. DNA visualization that has been electrophoresed is carried out with UV transmitters and if the band of DNA molecule looks bright then documentation is done.

E. Determination of RAPD marking Scoring

The ribbon pattern that appeared on the gel was translated into binary data with manual scoring. Each ribbon represents one character and is given a value based on the presence or absence of a ribbon. The number one "1" for the band formed and the number zero "0" for the ribbon that is not formed.

Each ribbon in a gel representing a DNA fragment from each plant genotype is assigned a value when the ribbon appears and is given a zero value when the ribbon does not appear. To determine genetic diversity, PCR - RAPD products are scaled based on the appearance of DNA bands. The tape that appears on the gel is assumed to be the RAPD allele. The diversity of the RAPD allele was determined by differences in the migration of alleles in the gel of each individual sample. Based on the presence or absence of the ribbon, the ribbon profile is translated into binary data. Emerging ribbons are coded 1 (existing) and 0 (none).

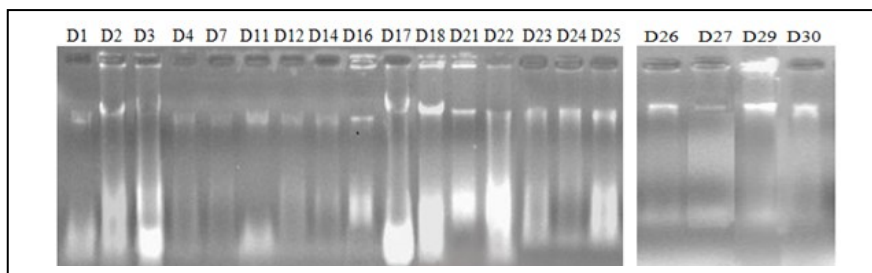

Electrophorogram of DNA Quality Test of Dxp 540 NG Varieties of Palm Oil (D = DNA Isolation Originating from the Leaf Section)

F. Determination of Base Pair Size

The base fragment size (base pair = bp) of the PCR product was determined using the UVITEC Cambridge FireReader software. The DNA fragment used is 1 kb DNA ladder Promega. By using Cambridge FireReader UVITEC software, the amplified DNA band size can be measured. The size of the DNA band (base pairs) will be aligned from the ladder we use. This program will measure the tape that appears based on the ladder size where the data size must be inputted first, see the ladder size guide used. The measurement of the formed band pattern with the DNA glow formed during the electrophoresis process with UV light.

VI. RESULT AND DISCUSSIONS

A. Test the quality of oil palm varieties D x P 540 NG

Based on DNA quality testing (Fig. 1), it showed that the banding patterns were firm and bright. This shows that the DNA produced is quite solid, intact and has a high concentration. Widiastuti, [12] states that thick and collected DNA bands show high concentration and the total DNA extracted is intact.

B. Test quantity of palm oil D x P 540 NG

TEST RESULTS FOR THE QUANTITY OF 20 DNA SAMPLES OF OIL PALM VARIETIES D X P 540 NG.

No	sample name	A _{260/280}	DNA Concentration (µg/ml)
1	D1	5,03	95,1
2	D2	1,74	796,3
3	D3	2,10	313,2
4	D4	1,37	1036,0
5	D7	1,88	636,9
6	D11	1,98	952,3
7	D12	1,77	936,2
8	D14	1,99	246,4
9	D16	2,02	122,5
10	D17	2,26	899,4
11	D18	2,02	336,2
12	D21	2,24	131,7
13	D22	2,50	408,5
14	D23	2,13	598,6
15	D24	1,85	406,8
16	D25	2,02	987,6
17	D26	1,52	338,6
18	D27	2,13	765,9
19	D29	1,45	584,6
20	D30	1,79	355,3

The oil palm quantity of the Dxp 540 NG variety was known that the purity of DNA from the samples tested has a ratio ranging from 1.37-2.50, except in the D1 sample which is 5.03. High DNA purity values occur because of human error at the time of the study. According [13] the purity level of DNA above 2.0 indicates that impure DNA is also caused by the presence of ethanol remnants during imperfect drying, another factor that causes impure DNA is the presence of secondary metabolite content. on extracted plant organs.

From the sample isolated only 4 samples whose purity ranged from 1.8 to 2.0, namely in samples number 7, 11, 14, and 24. This shows that the DNA sample was pure. Samples with purity values below 1.8 contained 6 samples, namely samples 2, 4, 12, 26, 29 and 30. This means that the sample contained protein contaminants. Samples with more than 2 purity were 10 samples, namely samples number 1, 3, 16, 17, 18, 21, 22, 23, 25, 27. This shows that DNA stocks still contain a lot of RNA contaminants. This is in accordance with the literature of [14] which states that the purity level of DNA is determined by the value of Comparison A260 / A280, pure DNA samples will produce an A260 / A280 ratio ranging from 1.8-2.0. purity values of more than 2.0 indicate that the sample contains RNA contaminants, while purity values less than 1.8 indicate that the sample contains protein contaminants.

From all tested samples, it is known that the sample has a non-uniform concentration. the lowest DNA concentration was found in the NG1 sample which was equal to 95.1 µg / ml while the highest concentration of DNA was found in the NG4 sample which was equal to 1030 µg / ml. The small amount of DNA produced is influenced by several factors during DNA extraction and sample conditions. According to [15] states that the concentration of extraction results is influenced by the time of extraction and the composition of the increase in lysis buffer.

The basic principle in spectrophotometry is that the sample must be clear and dissolve completely. There are no colloidal particles especially suspension. DNA containing purine and pyrimidine bases can absorb UV light. Double DNA bands can absorb UV light at 260 nm, while protein or phenol contaminants can absorb light at 280 nm. With this difference in UV light absorption, the purity of DNA can be measured by calculating the absorbance value of 260 nm divided by the absorbance value of 280, and the purity value of DNA ranging from 1.8 to 2.0 [16].

C. Visualization of Amplification Results

A total of 20 samples were analyzed using PCR machines. The PCR amplification results showed that there was 1 sample that was not amplified at OPB 07 primer and OPN 03 which was 23 samples.

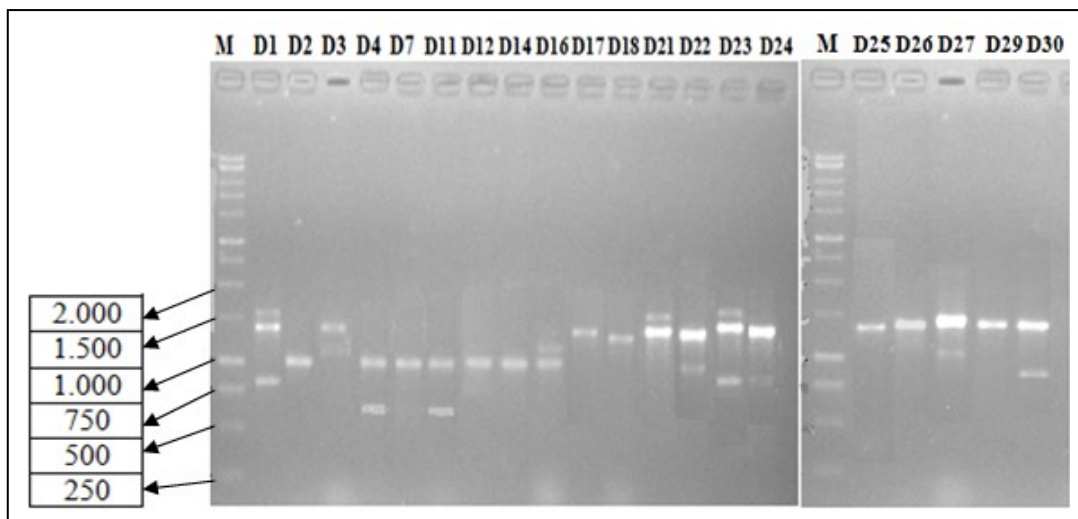

Electropherogram results of PCR with Primary OPA-13 in DxP 540 NG Oil, (M = Ladder Markers 1 kb (Promega), D = DNA Isolation Originating from the Leaf Section)

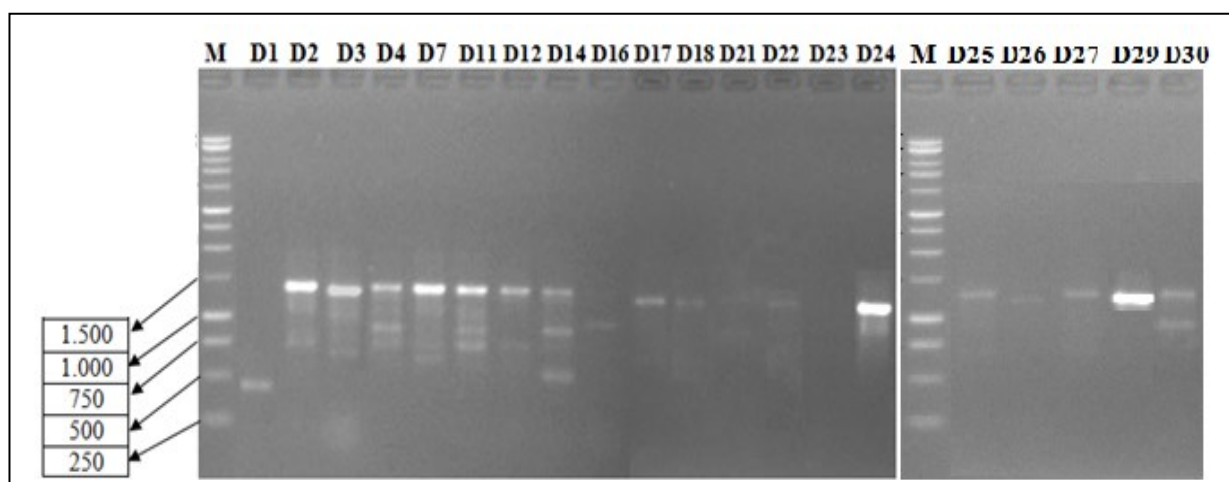

Electropherogram results of PCR with Primary OPA-07 in DxP 540 NG Oil, (M = Ladder Markers 1 kb (Promega), D = DNA Isolation Originating from the Leaf Section)

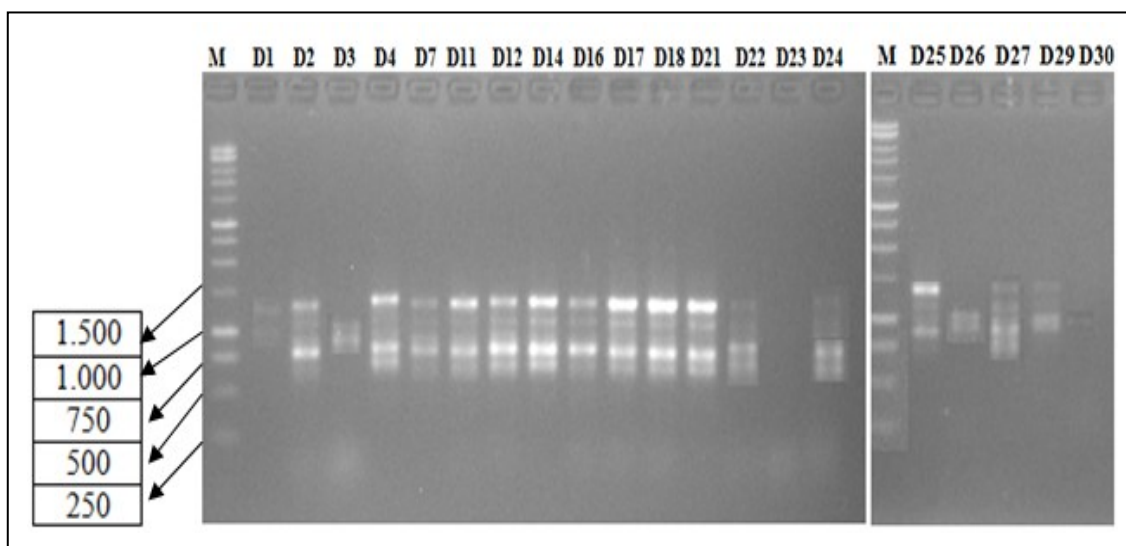

Electropherogram results of PCR with Primary OPA-03 in DxP 540 NG Oil, (M = Ladder Markers 1 kb (Promega), D = DNA Isolation Originating from the Leaf Section)

RESULTS OF AMPLIFICATION OF THREE RAPD PRIMERS

No	Primer Name	Base Sequence (5'-3')	Total of Amplified DNA
1	OPA- 13	CAGCACCCAC	5
2	OPB- 07	GGTGACGCAG	5
3	OPN- 03	GGTACTCCCC	4

D. Polymorphic percentage

PERCENTAGE OF POLYMORPHISM

Primer Name	Band Size (bp)	Σ		Monom orphic Band	%
		Pattern Band	Polymorphic Band		
OPA – 13	626-1574	5	5	0	100%
OPA – 07	446-1331	5	5	0	100%
OPA - 03	486-1321	4	4	0	100%
		14	14	0	300%
		4.6	4.6	0	100%

In Table 4, it can be seen that from the three primers with ribbon size, OPA-13 with a length of 626-1574 bp, OPB-07 with a length of 446-1331 bp, OPN-03 with a length of 486-1321 bp, and the number of banding patterns that appear namely, OPA-13 as many as 5 bands, OPB-07 as many as 5 bands, OPN-03 as many as 4 ribbons, Total ribbon patterns from the three primers that appear as many as 14 bands with an average of 4 bands per primer with 14 polymorphic ribbons and ribbons monomorphic 0 ribbon. The percentage of polymorphic bands is 100% for all primers.

In Table 4, it shows that the highest number of banding patterns is in the OPB-07 and OPA-13 primers with the number of 5 ribbon patterns, while the lowest band pattern is in the OPN-03 primer which amounts to 4 ribbon patterns.

The OPA-13 primer shows a ribbon pattern of 5 bands with a band size ranging from 626-1574 bp. Polymorphic ribbon presentation is 100% and monomorphic ribbon presentation is 0%. Electroperogram from PCR-RAPD amplification in fig.2.

The OPB-07 primer shows a ribbon pattern that consists of 5 bands with ribbon sizes ranging from 446-1331 bp. Polymorphic ribbon presentation is 100% and monomorphic ribbon presentation is 0%. The visualization of the PCR-RAPD amplification results in fig. 3.

The OPN-03 primer shows a ribbon pattern of 4 bands with a ribbon size of 486-1321 bp. Polymorphic band percentage of 100% and monomorphic ribbon presentation of 0%. The visualization of the PCR-RAPD amplification results is in fig. 4.

Detection of genetic diversity in this study using RAPD markers, because RAPD markers are informative markers, can be used to detect polymorphism. [8] states that RAPD markers are informative molecular markers, can be used to detect polymorphisms between commercial MTG palm oil germplasm access and are able to classify the genetic background of MTG oil palm varieties and are an important tool for genetic analysis of germplasm this main palm oil.

In this study it is known that the number of DNA bands produced by the OPA-13 primary number of bands is closely

related to the primary work process in recognizing the existence of attachment sites in the DNA template. Poerba and Yuzammi [17] state that the more attachment sites of primers used in printed DNA, the more the number of DNA bands produced.

Polymorphic bands are bands that are not found in all samples. In this study it was known that polymorphic ribbon presentations were 100% and presentations of 0% monomorphic. High polymorphic ribbon presentations show high variation in each palm oil sample studied. According to [18] states that the more polymorphic bands produced it will be easier to observe variations.

The level of polymorphism is needed to choose markers that can distinguish between the lines used. Putri [4] states that the level of polymorphism obtained from the analysis of molecular markers is very important information for plant breeders to be a reference to see the richness of gene diversity.

VII. CONCLUSION

The polymorphisms of the three primers used were OPA-13, OPB-07 and OPN-03 at 100% with bases of OPA-13 with lengths 626-1574 bp, OPB-07 with lengths 446-1331 bp, OPN-03 with length 486 -1321 bp, and the number of ribbon patterns that appeared, namely, OPA-13 as many as 5 bands, OPB-07 as many as 5 bands, OPN-03 as many as 4 bands.

Further research is needed for the genetic performance of the DxP 540 NG variety of oil palm plants using different primers in order to increase the higher kinship accuracy

REFERENCES

Sukarno. 2009. Budidaya dan Pengelolaan Kebun Kelapa Sawit dengan Sistem Kemitraan. Jakarta (ID); Agromedia Pustaka. 178 p.

Purnamila, S., A Widyatmoko, I Nurtjahjaningsih. 2014. Keragaman Genetik Anakan *Shorea leprosula* Berdasarkan Penanda Mikrosatelit. Yogyakarta.

Suryanto D. 2003. Melihat keanekaragaman organisme melalui beberapa teknik genetika molekuler. USU Digital Library [terhubung berkala]. <http://www.library.usu.ac.id/modules.php> [23 November 2013].

Putri, L. A. P. 2010. Pendugaan Parameter Genetik dan karakterisasi molekuler kergaman genetik dengan marka mikrosatelit (SSR) pada kelapa sawit. Disertasi. Program Pascasarjana IPB. Bogor.

Azrai, M. 2006. Sinergi Teknologi Marka Molekuler dalam Pemuliaan Tanaman Jagung. Balai Penelitian Tanaman Sereal. Makassar.

Bangun, S. I. T. 2007. Marka Molekuler. Fakultas Biologi Universitas Nasional. Jakarta.

Bardacki, F. 2001. Peran Marka Molekuler Dalam Pemuliaan Tanaman. Badan Litbang Pertanian. Edisi 16-22 Maret 2011 No. 3397. Hal. 36.

Putri, L. A. P., Setyo, I. E., Basyuni, M., Bayu, E. S, Setiadi, H., Reynaldi, N. F., Laia, H., Puteri, S. A. K., Arifiyanto, D., Syahputra, I. 2018. Molecular performance of commercial MTG variety oil palm based on RAPD markers. *IOP Conf. Ser. : Earth Environ. Sci.* 122 012078.

Anggereini, E. 2008. Random Amplified Polymorphic DNA (RAPD), Suatu Metode Analisis DNA Dalam Menjelaskan Berbagai Fenomena Biologi, 1(2), 73- 76.

Karsinah, Sudarsono, Setyobudi, L., dan Aswidionnoor, H., 2002. Keanekaragaman Genetik Plasma Nutfah jeruk berdasarkan

- Analisis Penanda RAPD. Jurnal Bioteknologi Pertanian. . Fakultas Perranran, Instrtut Pertanian Bogor.
- Orozco-Castillo, KJ. Chalmers, R Waugh & W. Powell. 1994. Detection of Genetic Diversity and Selective Gene Introgression In Cyoffe Using RAPD MRKERS. Theor. Appl. Genet. 87. 934-940.
- Widiastuti, A. 2017. Prinsip Umum Pengujian DNA. Benih Tanaman Balai Besar PPMB-TPH
- Fatchiyah, Arumingtyas EL, Widyarti, S, Rahayu S, 2009. Dasar-Dasar Biologi Molekuler, Brawijaya Press, Malang.
- Wilson, K. And Walker, J. 2010. Biochemistry and Molecular Biology. Cambridge University Press. New York.
- Komalasari, K. 2009. Pengaruh Perbandingan Volume Darah Dan Lisis Buffer Serta Kecepatan Sentrifugasi Terhadap Kualitas Produk Dna Pada Sapi *Friesian Holstein* (Fh). Fakultas Peternakan. Institut Pertanian Bogor. Bogor
- Fatchiyah, 2011. Pelatihan analisis fingerprinting DNA tanaman dengan metode RAPD. Modul. Laboratorium sentral ilmu hayati Universitas Brawijaya, Malang.
- Poerba, Y. S. Dan Yuzammi. 2008. Pendugaan keragaman genetic *Amorphophallus titanum* Becc berdasarkan marka Random Amplified Polymorphic DNA. Biodiversitas 9 (2): 103-107.
- Azizah, A. 2009. Perbandingan Pola Pita Amplifikasi DNA Daun, Bunga Kelapa Sawit Normal dan Ab.normal. Institut Pertanian Bogor. Bogor.

Cause of Delay and Waste Time Turbine Hall PLTU Semarang

1st Harsoyo, Y.A
 Civil Engineering Study Program
 Faculty of Engineering
 Yogyakarta, Indonesia
 Yogaharsoyo@gmail.com

2nd Arkan, M.R
 Civil Engineering Study Program
 Faculty of Engineering
 Yogyakarta, Indonesia
 Rezaarkan78@gmail.com

Abstract— *In a construction project development will always have some problems that can cause delays and waste time. From the planning process, procurement until the installation process will be faced with various technical and nontechnical problems that must be able to minimized as well as possible by all sides of the construction project. Workers in construction projects such as main contractors and subcontractors are workers who often face problems directly at the construction project. Similar with the other construction project, at Turbine Hall PLTU Semarang was found some problem that became some factors of delay and waste time. This research was conducted to determine the factors that can cause delays and waste time according to some elements of the workers, it was main contractors and sub-contractors that working on the project. The results of questionnaire obtained from that two elements of workers are then analyzed by using descriptive analysis with SPSS for the cause of delays and borda analysis for the cause of waste time. From the result of both analysis then will be following with ranking analysis to know what are the major factors from delays and waste time.*

Keywords— *Delay factor, Waste time factor, Construction Management Construction project.*

INTRODUCTION

Construction project development is a development that often faced various of problems, both from the planning process until the process of execution will always face some constraints and problems. Problems that occur in the project are often need time for the completion. Not only delays that happen at the construction project, waste time also happen generally caused by waste of material and resources, causing the project not optimize the process.

Same with other construction projects, our research subject construction of the Turbine Hall PLTU Semarang is also had various problem of delays and waste time because of the high complexity of the project and the size of field that big and extensive then mobilization is required to be able complete the project properly.

The fact in the field is the cause of delays and waste time on a project varies. Factors that cause delays and waste time may be technical and non-technical factors, it is based on the problems that occur throughout the development of the project.

Same with the delay implementation of construction project in Kupang City that researched by Messah, et al (2013). On the implementation of the project encountered several barriers that caused delays, as presented by the contractor on the project that the unavailability of Labor

became one of the factors causing the delay. In addition, according to the project parties there is a delay in the delivery of material to the location is a considerable factor, so it can be ensured that in every construction project will surely found some problems that causes the delays and waste time.

LITERATURE REVIEW

Construction Management

According to Hassan, et al (2016) Construction management is a project that has a wide scope, here are the stages of a construction management:

- a. Planning (planning)
 Planning is a process that tries to lay the foundation of goals and objectives including preparing all the resources to achieve it.
- b. Organizing (organizing)
 Organization is a vital tool for the control and implementation on the project. Project organization is called successful if the project able to control three main things, it was quality, time and cost. An organization is characterized by a group of people that working together on the basis of the rights, obligations and responsibilities of each jobdesk.
- c. Execution
 Implementation activities include the implementation of working at the field in order to realizing the building to be built.
- d. Supervision (controlling)
 Supervision activities are carried out with the aim of the implementation building progress accordance with the requirements set.

Project Delays

In a journal examined by Messah, et al (2013) mentions that said the delay can be categorized into three main types:

- a. Unpardonable delays
 The delay is a delay caused by the negligence of the action and error of the contractor in its workmanship.
- b. Pardonable delays
 Pardonable delays is a delay caused by matters beyond the control of the contractor or the project owner. In this case the contractor is given a compensation of time to process the project.

c. Delays are eligible for compensation

Such delays are a delay caused by the owner's fault. In these cases, contractors will be given extra time and additional operational costs in the process.

Causes of Delays

According to Wirabakti, et al (2014) There are several factors that affect the delay of the project implementation:

- a. Labor
- b. Materials
- c. Place characteristics
- d. Managerial
- e. Equipment
- f. etc

Further research on the cause of delays in a construction project has also been examined by Bakhtiyar, et al. (2012) conducted on the construction project of the building in Lamongan City. From the study can be concluded as follows:

- a. Analysis of the factors that are the cause of delays in building construction projects in the city of Lamongan collected based on the respondents from the contractor and owner of the project.
- b. For level analysis of the factors that have been obtained using path analysis method is by determining the scale of delay.

In research conducted by Pratas, et Al (2017) indicates there are several inhibitory factors that can cause delays due to lack of readiness of safety equipment on a project. One of the factors that became the most influential inhibitory factor is the lack of training on K3 because the company considered with the implementation of K3 process will increase the value of the project.

Waste Time

Construction projects are generally still problematic with resource of inefficiencies and wasting time in the process, non-value-added work will produce highly inefficient resources and cause waste activities Ristyowati, et Al (2017). Waste time also researched by Untu, et Al (2014) mentions that there are various kinds of waste that can happen to a construction project such as defects in products, excessive production, waiting and unapropriate processing. The research on the causes of waste is also done by Artika (2014) At the construction project of the DPRD-district legislator, Ogan Ilir. It can be taken some conclusions from the study:

- a. The most dominant variable waste occurs in the project is awaiting the arrival of materials caused by several factors such as bad weather and equipment malfunction.
- b. In terms of cost if the project buffer is not used at all then the savings will be obtained from the reduction of labor costs.
- c. There are other indicators that cause waste such as problems in the provision of resources and the financial condition of the project is not good.

Research of Lean Project management in order to minimize the occurrence of waste on a construction project is examined by Prisilia, et Al (2018) on the construction of the SMAN 1 Giri building Banyuwangi Regency. Here are some conclusions from the research

- The result of identification of waste resulting in waste waiting and waste defect are happened there.
- Waste waiting that occurs due to the delay in the material reserve, the delay of the funds and equipment that often damaged.

Research of the causes of waste is also done by Artika (2014) At the construction project of the DPRD-district legislator Ogan Ilir. It can be taken some conclusions from the study:

- a. The most dominant variable waste occurs in the project is awaiting the arrival of materials caused by several factors such as bad weather and equipment malfunction.
- b. In terms of cost if the project buffer is not used at all then the savings will be obtained from the reduction of labor costs.
- c. There are other indicators that cause waste such as problems in the provision of resources and the financial condition of the project is not good.

Questionnaire Plan

For the questionnaire factor on this study refers to the journal Messah, et al (2013) for the cause of delays and research factors of Mudzakir, et al (2017) for the cause of waste time. There are 20 variables of question in each questionnaire. The respondent of this research are 9 workers from main contractor and 11 workers from subcontractor of Turbine Hall PLTU Semarang.

RESEARCH METHODS

Stages of Research

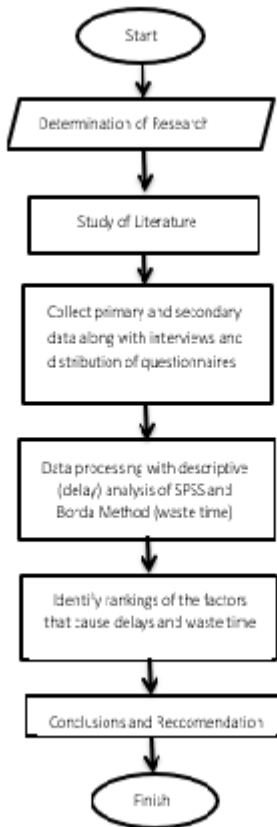

Fig. 1. Flowchart

Data Processing Methods

There are the following stages explanation of data processing on the construction of Turbine Hall PLTU Semarang:

1. Compared the schedule of the project between plan schedule with the actual schedule to get some late activities.
2. Conduct a validity and reliability test of the questionnaire to determine whether the questionnaire can be used for this research and subsequent research.
3. Performs a descriptive analysis with SPSS to know the strength of each question variable in the questionnaire of delay factors with the output of "mean "
4. Conducting borda analysis to find out the strength of each variable questionnaire causes waste time factor with the output of "weights "5. Analysis of late ranking and Waste Time.
5. Conducting the ranking analysis from the score of "mean" for delays factor and "weights" for waste time factors

Results and Discussion

Methods of Analysis

After got the results from schedule comparison analysis of some late work by comparing the planning schedule and the actual schedule, then proceed with determining the descriptive analysis for the delay factor and borda analysis for waste time factor. The following figure are

an example of schedule comparison planning results with actual schedule:

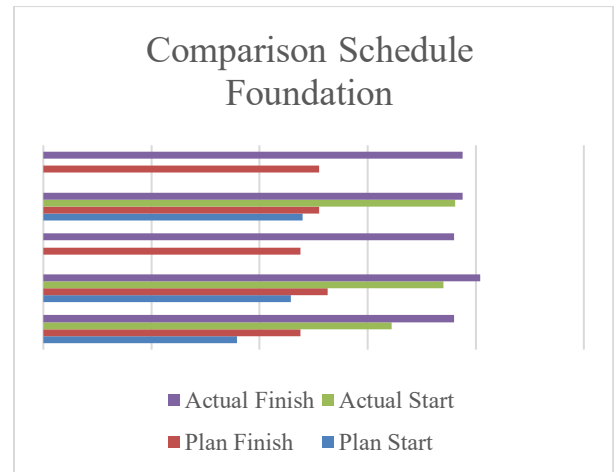

Fig. 2. Schedule Foundation Comparison Chart.

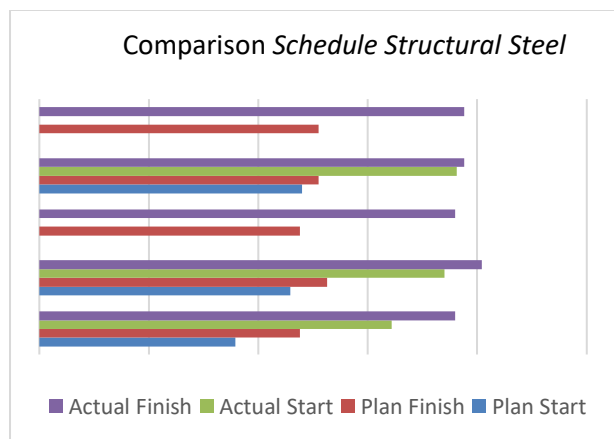

Fig. 3. Schedule Foundation Comparison Chart .

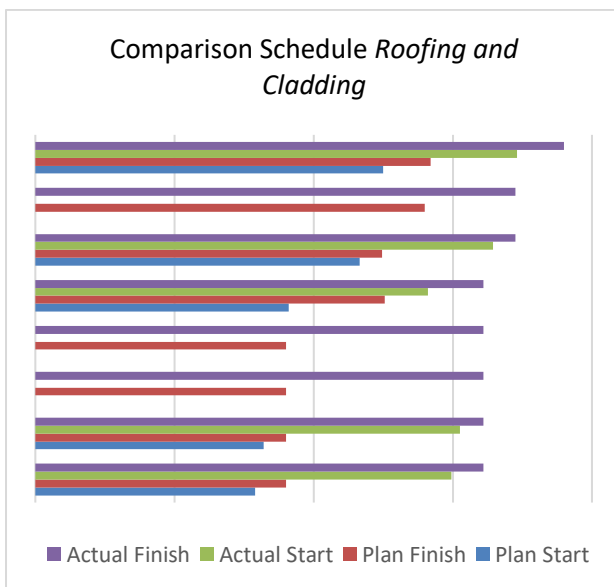

Fig. 4. Schedule Foundation Comparison Chart.

Validity and Reliability

Before starting the research with several predefined methods, it is recommended that the validity and reusability test (trust, consistency, reliability) of the research instrument to be used is a questionnaire. If the scale is grouped into five classes with the same range then the size of the alpha stability can be presented as follows:

TABEL 1. TERMS OF THE CRONBACH ALPHA VALUE

No	Information	Alpha	Reliable
1	Alpha Cronbach	0.00-0.20	Less Reliable
2	Alpha Cronbach	0.21-0.40	Rather Reliable
3	Alpha Cronbach	0.41-0.60	quite Reliable
4	Alpha Cronbach	0.61-0.80	Reliable
5	Alpha Cronbach	0.81-1	Very Realiabe

TABEL 2. DELAY QUESTIONNAIRES TEST

Delay Questionnaires	
Cronbach's Alpha	Item
0,984	20

TABEL 3. WASTE TIME QUESTIONNAIRES TEST

Waste Time Questionnaires	
Cronbach's Alpha	Item
0,902	20

Descriptive Analysis (Delay factor)

Based on the questionnaires data that has been obtained, will be obtained results from the cause of delay in the subject of research. Furthermore, the descriptive analysis using SPSS based on two elements of workers are the main contractors and sub-contractors on the construction project Turbine Hall tambak Lorok Block 3 Semarang.

Rangking Analysis (Delay factor)

In the analysis of the following delay factor ranking is determined based on the order of the largest mean value towards the smallest mean value of descriptive analysis from both elements of the worker's main contractor and sub-contractor on the Turbine development project Hall Tambak Lorok Block 3 Semarang. The following are the results of the ranking analysis that has been analyzed:

TABEL 4.MAIN CONTRACTOR DELAY FACTORS

Rank	Delay Factors	Mean
1	Design Change	4.44
2	Identification and sequence of work that is not in accordance with the plan	3.67
3	Changes to the date of commencement of the project are not appropriate	3.56

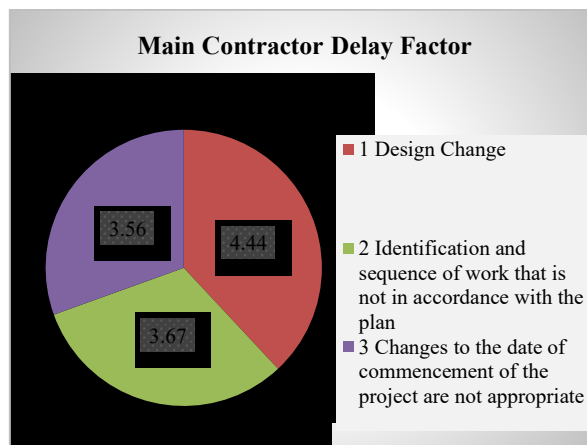

Fig. 5. Main Contractor Delay Factors.

In the figure above shows a pie chart of the ranking analysis that has been done. Here's the explanation:

1. Chart Orange: The result of interview from the respondents explained that design changes occurred because on the project with the EPC level there is complexity in the acceptance of image results from among the relevant parties. So that design changes will be quite common
2. Chart Gray: Identification and the wrong order of work is one of the main factors due to each change in design will be followed by changes in working methods and stages of work. Then it will cause delays and extravagance.
3. Yellow Chart: Change of the project start date changed because it was required to follow the date of completion of the planning process and switch to construction process of Turbine Hall Semarang.

TABEL 5. SUBTRACTOR DELAY FACTORS

Rank	Delay Factors	Mean
1	Design Change	4.36
2	Identification and sequence of work that is not in accordance with the plan	3.73
2	Changes to the date of commencement of the project are not appropriate	3.73

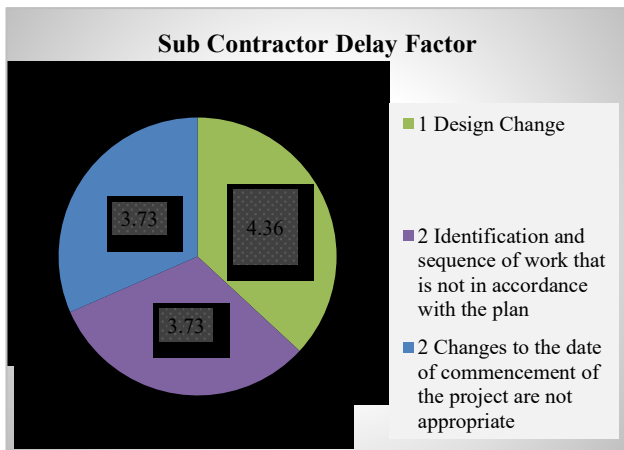

Fig. 6. Subcontractor Delay Factors

In the picture above shows a pie chart against the ranking analysis that has been done. Here's the recutability:

1. Chart Orange: The result of interview from the respondents explained that design changes occurred because on the project with the EPC level there is complexity in the acceptance of image results from among the relevant parties. So that design changes will be quite common
2. Chart Gray: Identification and the wrong order of work is one of the main factors due to each change in design will be followed by changes in working methods and stages of work. So it will cause delays and extravagance
2. Yellow Chart: Change of the project start date changed because it was required to follow the date of completion of the planning process and switch to construction process of Turbine Hall Semarang.

Borda Method (Waste time factor)

In the analysis that causes waste time in the construction project of Turbine Hall PLTU Tambak Lorok Block 3 Semarang is used borda analysis to determine the weight from each variable factor of waste time. The methods that we use based on the research conducted by Ahmad Chasan, et al (2017) that using borda analysis also.

Ranking Analysis (Waste time factor)

At the ranking analysis of waste time factors are determined by the order of the largest weight value towards the smallest weighted value based on the calculation result with the borda analysis from both worker elements of the main contractor and sub-contractors on construction project of Turbine Hall Tambak Lorok Block 3 Semarang. The following table and figure are the results of ranking analysis that has been analyzed:

TABEL 6. MAIN CONTRACTOR WASTE TIME FACTORS

Rank	Waste Factor	Weights
1	Image specifications are not clear	0.089
2	Design changes	0.088
3	Rework / Repair	0.084

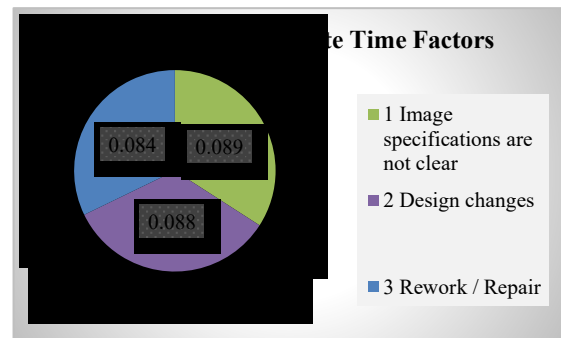

Fig. 7. Main Contractor Waste Time Factors.

From the results are obtained several factors that caused waste time in the subjects studied. Here it is the explanation to clarify the waste time chart:

1. Orange Chart: Image that is not clearly become one factor in the occurrence of waste time because of the improvement of DED will cause waste to the time and workers who are ready to work on the construction process of Turbine Hall PLTU Semarang
2. Chart Gray: The result of interview from the respondents explained that design changes occurred because on the project with the EPC level there is complexity in the acceptance of image results from among the relevant parties. So that design changes will be quite common
3. Yellow Chart: Rework or repairs to the project in question is a rework of the design that is formulated. It will be a waste of time due to repeated images will take time and cause workers idle construction process.

TABEL 7. SUBCONTRACTOR WASTE TIME FACTOR

Rank	Waste Factor	Weights
1	Image specifications are not clear	0.088
2	Design changes	0.079
2	Rework / Repair	0.079
3	Error on Job instruction	0.076

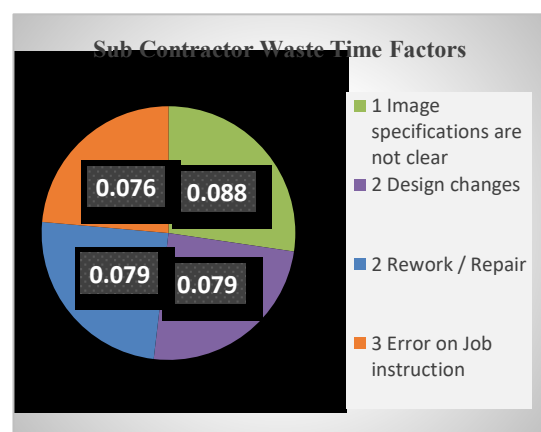

Fig. 8. Sub Contractor Waste Time Factors

From the above results are obtained several factors that are the cause of waste time in the subjects studied. Here is a description to clarify the waste time chart in Fig. 5. I.e:

1. Chart Orange: Image that is not clearly become one factor in the occurrence of waste time because of the improvement of DED will cause waste to the time and workers who are ready to work on the construction process of Turbine Hall PLTU Semarang
2. Chart Gray: The result of interview from the respondents explained that design changes occurred because on the project with the EPC level there is complexity in the acceptance of image results from among the relevant parties. So that design changes will be quite common
3. Yellow Chart: Rework or repairs to the project in question is a rework of the design that is formulated. It will be a waste of time due to repeated images will take time and cause workers idle construction process.
4. Blue Chart: Work order fault can occur because it must adjust to the latest plan changes that will apply to the construction project Turbine Hall PLTU Semarang

CONCLUSIONS AND SUGGESTIONS

Conclusions

Based on the results of some analysis and the discussion has been obtained several conclusions as follows:

Delay main factor:

- According to Main contractor

Based on the results of research that have been done can be concluded that the main factors for delay from main contractor is design change factor.

- According to Sub contractors

Based on the results of research that have been done can be concluded that the main factors for delay from sub contractor is design change factor.

Waste time factor:

- According to Main contractor

Based on the results of research that have been done can be concluded that the main factors for waste time from main contractor is Image specifications are not clear.

- According to Sub contractors

Based on the results of research that have been done can be concluded that the main factors for waste time from main contractor is Image specifications are not clear.

Suggestions

Based on the results of the study can be given advice for subsequent studies that the results of this research can be used as a result of comparison with subsequent research. In addition, it is expected to the next study to review the factors causing delay and waste with more detail on an aspect

accompanied by other methods that support this kind of research.

REFERENCES

- Artika, D., 2014. Application of Lean Project Management method in construction project at the construction of Ogan Ilir Regency Building. *Journal of Civil and Environmental Engineering*, 2 (1).
- Bakhtiyar, A., Soehardjono, A., and Hasyim, M.H., 2012. Analysis of factors affecting the delay of construction of buildings in Lamongan City. *Journal of Civil Engineering*, 6 (7), 1978-5658.
- Hassan, H., Mangare, J. B. and Pratasis, P. A., 2016. Factors causing delays in construction projects and alternative resolutions (case study: in Manado Town Square III). *Static civil Journals*, 4 (11), 657-664.
- Messah, Y. A., Widodo, T., and Adoe, M. L., 2013. Research causes delay implementation of building construction project in Kupang City. *Journal of Civil Engineering*, 2 (2).
- Mudzakir, A. C., Setiawan, A., Wibowo, M. A., and Khasani, R. R., 2017. Evaluation of Waste and implementation of Lean Construction (case study: Multipurpose Building Project of Taruna Polytechnic, Semarang Sailing science). *Journal of Civil Engineering*, 6 (2), 145-148.
- Pratasis, P. A., and Mangare, J.B., 2017. The implementation of management system of K3 in the construction project in Manado City. *Static civil journal*, 187-19
- Prisilia, H., and Purnomo, D. A., 2018. Application of Lean Project Management method in construction project planning at the construction of State high School building 1 Giri Banyuwangi regency. *Journal of Time Engineering*, 16 (01), 1412-1867
- Ristyowati, T., Muhsin, A., and conscience, P. P., 2017. Lack of Waste on the activities of production process with the concept of Lean Manufacturing (case study at PT. Sport Glove Indonesia). *Journal OPTIONS*, 10 (1), 1693 – 2102.
- Untu, S. H. S., Dundu, A. K. T., and Mandagi, R. J. M., 2014. Application of Lean Project Management methods in construction project planning (case study: Construction of building Mantos phase III). *Static civil Journals*, 2 (06), 320-329.
- Wirabakti, D. M., Abdullah, R., and Maddeppungeng, A., 2014. Study of causes of delays in building construction project. *Journal of Constructia*, 6 (1).

Analysis of Operation Pattern of the Bajulmati Reservoir

¹ Erlin Susanti

Student of Civil Engineering
Department
Faculty of Civil, Environmental &
Geo Engineering,
Institut Teknologi Sepuluh Nopember
(ITS)
Sukolilo Surabaya, 60111, Indonesia
susantierlin80@gmail.com

² Umboro Lasminto

Civil Engineering Department
Faculty of Civil, Environmental &
Geo Engineering,
Institut Teknologi Sepuluh Nopember
(ITS)
Sukolilo Surabaya, 60111, Indonesia
umboro.lasminto@gmail.com

³ Theresia Sri Sidharti

Civil Engineering Department
Faculty of Civil, Environmental &
Geo Engineering,
Institut Teknologi Sepuluh Nopember
(ITS)
Sukolilo Surabaya, 60111, Indonesia
theresia.sri.sidharti@gmail.com

Abstract—Banyuwangi Regency is a developing city with the majority of people's livelihoods coming from the agricultural sector. With population growth, the need for raw water and irrigation will increase. Some problems that often occur in Banyuwangi are the occurrence of drought in the dry season and during the rainy season always experiencing a surplus of water which causes flooding and the current condition of the reservoir has not fully provided optimal benefits. So in this study trying to do "Analysis of the Bajulmati Reservoir Operation Pattern" so that the reservoir is expected to provide optimal performance both in the utilization for irrigation, raw water and Micro Hydro Power Plants (PLTMH). This research begins with a literature study, data collection, data analysis for the availability and utilization of reservoir water by hydrological modeling in the form of calculation of Bajulmati River flowrate as reservoir inflow using the FJ Method. Mock Followed by stretching the reservoir flow forward for 50 years with the Markov Method. Furthermore, the formation of models and simulations. Simulation results show the operation of reservoirs (alternative two) produces electricity (PLTMH) higher than alternative one, the second alternative is able to increase electricity production on average per year to 2,823 GWH (122.74% of current conditions) if the turbine must be fully operational (alternative 2A) and 2,852 GWH (124.00% of current conditions) if a turbine with 20% maximum power is already operating (alternative 2B), with irrigation water fulfillment (kT factor) 2.26. From the income analysis (without calculating costs and assuming irrigation water is carried out simultaneously) it is known that the highest income obtained alternative 1B of Rp. 338.69 billion, the next highest is alternative 1A of Rp. 338.41 billion, the third highest alternative 2B of Rp. 313.03 billion and the lowest alternative income 2A was Rp. 313.00 billion.

Keywords—pattern of reservoir operation, simulation, water balance

I. INTRODUCTION

Water needs cannot always be fulfilled by existing water resources, therefore water resources engineering is needed, including the construction of reservoirs. Reservoirs are a means of utilizing water resources that have the function of storing, supplying water and

controlling floods in the rainy season. Reservoirs in a general sense are places on the surface of the land that are used to collect water when there is excess water in the rainy season so that the water can be utilized in the dry / dry season (Suharyanto, 1997).

Excess water in the rainy season can be accommodated and stored and used appropriately, on time and on target throughout the year.

Current conditions, as time goes on, many reservoirs in Indonesia experience a decline in function and performance. This is caused by, among other things, the incompatibility of reservoir planning with the current operating conditions of the reservoir, the decrease in inflow due to changes in ecosystems and land use in the upper reaches of the river, the low reliability of reservoirs due to not optimal electricity production and reservoir operation patterns it is no longer compatible with the current conditions.

One of the new reservoirs that is still possible to be optimized is the Bajulmati Reservoir, which is located in 2 (two) districts, namely Banyuwangi and Situbondo District, East Java Province, precisely in Watukebo Village, Wongsorejo District, Banyuwangi Regency. This is due to the incompatibility of the reservoir planning with the current conditions of the reservoir operation.

The main objectives of the construction of the Bajulmati Dam are for irrigation water, raw water, the potential of micro hydro power plants, tourism, water conservation and stocking fish fisheries. This reservoir irrigates the Bajulmati Irrigation Area (DI) with a total area of + 1,800 ha which includes the Bajulmati Main Canal, Banyuwangi Regency covering an area of 1,322 Ha and the Wonorejo Main Canal, Situbondo Regency covering an area of 478 ha. This DI is limited by Bajulmati River, Sumber Mailang River and Curah Tangkup River in the west which is upstream of Bajulmati Reservoir, to the north which is bounded by Wonorejo Main Canal and Bali Strait which are boundaries to the east and Bajulmati Main Channels and Bulk Bandulan Rivers which limits the southern part which is also downstream of the Bajulmati Reservoir that goes to Bajulmati Dam. This DI

gets water from the Bajulmati Reservoir via Bajulmati Dam. The location of the Bajulmati Reservoir can be seen as shown in Fig. 1.

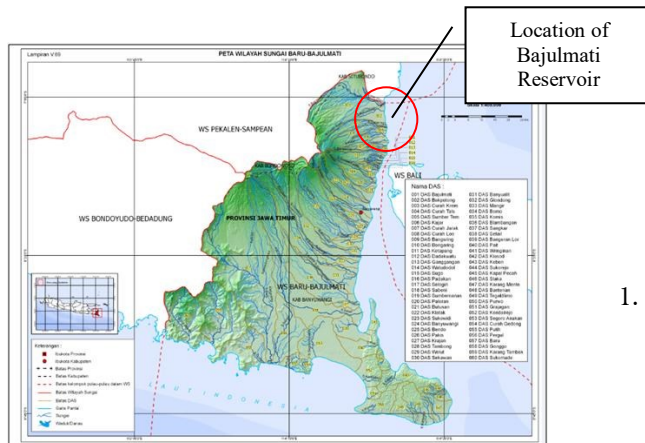

Fig. 1. Location of Bajulmati Reservoir

Aside from being a water provider for irrigation, the Bajulmati Reservoir also functions as a raw water provider of 0,18 m³/second. However, currently there is no raw water pipeline network related to land acquisition issues. The location of the reservoir that has a bumpy hill topography with a height ranging from + 90-115 m elevation to the base of the Bajulmati River makes the raw water pipeline difficult to implement, causing some areas to experience a clean water crisis. Some surrounding communities also choose to utilize existing surface water sources. Another function of the Bajulmati Reservoir is for microhydro power with an electric power plan capacity of 2x175 kW, while its annual energy production reaches 33,60 GWH. However, currently the electricity production has never been fulfilled (the average electricity production is 2,300 GWH per year based on data from the Indonesia Power statistics, 2018), this is because electricity production depends on water requirements for irrigation. So that every year the micro hydro power plant does not function during the dry season because the availability of irrigation water does not meet the minimum flow to drive the turbine. One of the efforts to improve reservoir operations and is expected to provide high benefits is by analyzing the Bajulmati Reservoir Operating Pattern with the simulation preparation method with the aim of knowing the current reservoir operational pattern and obtaining a reservoir operation pattern so that the reservoir can function optimally and know the suitability based on the simulation in the future according to the age of the reservoir plan and obtain conclusions from the simulation results.

II. PATTERN OF RESERVOIR

Optimization techniques can be defined as the preparation of a system model that is in accordance with real conditions and can be formed into a mathematical model with the separation of product elements, in order to obtain a solution that is suitable for the purpose of decision making. The definition of optimization is closely related to maximization but with a constraint. Optimizing is identical to maximizing with limited resources.

Optimization in the management of water resources is divided into categories, namely before the finished water building, and after the building is finished. Optimization of finished water buildings is the operation of the water and generally by maximizing net benefits (net benefits). The operation of water is said to be optimum if water resources or other resources are limited. The use of reservoir water is said to be optimum if irrigation needs can be met and if the rainy season never spills the spillway.

There are several ways to determine the pattern or policy of operating reservoirs, these methods include :

1. Distribution of allotment zones and by way of a pattern (rule curve),,
2. Standard Operating Procedure,
3. Stochastic or Implicit Deterministic Program,
4. Linear Program dan,
5. Stochastic Program (Suharyanto, 1997).

Taking into account the variables that must be taken into account in the model, as well as the field conditions, the determination of operating patterns using optimization and simulation techniques is an option, and is expected to overcome various problems and obstacles that arise in the operation of reservoirs (Nailil Afifah, 2013).

The operation of the reservoir is essentially an activity in terms of regulating/determining the amount of outflow, *O* to get the maximum benefit, taking into account the availability of water (inflow, *I*), and the capacity of the reservoir concerned (storage, *S*), on an ongoing basis. This definition is usually expressed in the form of a balance formula that has been applied, i.e. inflow-outflow = storage. Reservoir operations include collection and processing of hydrological data, preparation of reservoir operation patterns and annual plans for reservoir operations, carrying out reservoir operations in various conditions (normal, wet and dry). The reservoir operation pattern includes procedures for removing water from the reservoir in accordance with the conditions of the volume and / or elevation of the reservoir water and water requirements and the capacity of the river in the downstream of the reservoir. The reservoir operation pattern is made based on the characteristics of each reservoir both a single reservoir and a reservoir with a multi-purpose reservoir function. The reservoir operation pattern is manifested in the form of an operating zone rule curve which is limited by the curvature of the upper normal operating limit and the lower normal operating boundary curve and the planned intake of water and expenditure. In one year 2 (two) types of reservoir operation patterns are made, namely:

- a. The operation pattern of the rainy season reservoir, applies when filling reservoirs (November to April).
- b. The pattern of dry season reservoir operations, applies when emptying reservoirs (May to October).

The purpose of composing a reservoir operation pattern is to use water optimally to achieve maximum capacity of the reservoir by proportionally allocating it so that there is no conflict between interests. Efficient and optimal operation of the reservoir is a complex problem because it involves several factors such as:

1. Pattern of reservoir operation policy.
2. The inflow discharge that will enter the reservoir depends on the accuracy of the discharge planning that will enter the reservoir.
3. Water requirements for utilization such as irrigation, raw water and micro hydro power plants.
4. Accuracy in planning the flood discharge that will occur.
5. Reliability of reservoir water level monitoring equipment, flow discharge and rainfall.
6. Coordination between relevant agencies.
7. Operational capabilities.
8. Short-term, mid-term and long-term operations coordination and real time operations.

III. METHODOLOGY

The availability of water in the reservoir is expressed as reservoir capacity which is a limiting factor for the reservoir operating system. Reservoirs have physical characteristics which are the main part of the reservoir. Reservoir capacity can be divided into three (Linsey, et. al. 1996), namely dead capacity/volume, is a minimum capacity that must be fulfilled by a reservoir, effective capacity / volume, is an ideal capacity for conservation of water resources (providing irrigation, raw water, recreation and others, maximum capacity, namely the maximum capacity that can be accommodated by the reservoir, maximum water level, minimum water level, height of the spillway building based on planned discharge. In addition to capacity, another factor that influences reservoir operations is the volume of water requirements The volume of water released must be within the minimum limit and maximum limit of reservoir operation of the reservoir characteristics, the relationship between elevation and volume of reservoirs is also known as the capacity of the reservoir. in the reservoir at each water level, increase in storage between d the two elevations are usually calculated by multiplying the average area at both elevations with the difference in elevation. The sum of all increments below an elevation is the volume of the pool below that height. The relationship between reservoir volume and inundation area with elevation above sea level can be seen in Fig. 2.

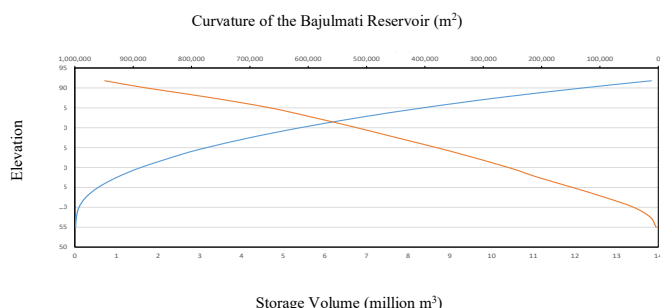

Fig. 2. Curved gr

Hydrological Analysis

Through a search of the topographic map, we will get the Bajulmati River Basin. This Bajulmati watershed has an area of 98,430 km² and is presented in Fig. 3.

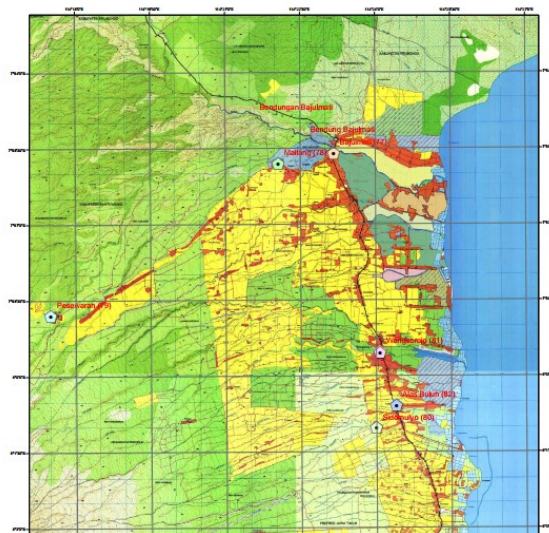

Fig. 3. Bajulmati Watershed and Rain Station Station Location

From the Rain Station Station data, it is known that there are 6 Station Stations located in and around the Bajulmati watershed. The Rain Station Station includes Bajulmati Station Station, Mailang Rain Station Station, Pasewaran Rain Station Station, Sidomulyo Rain Station Station, Wongsorejo Rain Station Station and Alas Buluh Rain Station Station. For more details, data for each Rain Station Post can be seen in Table I.

TABLE I. DATA OF POS RAIN STATION NEAR THE BAJULMATI WATERSHED

Station Name	Alas Buluh	Bajulmati	Mailang
Station Code	186	179	179.A
South Latitude	-7,5755	-7,5557	-7,5633
East Longitude	114,3628	114,3885	114,3541
Elevation	25 mdpl	32 mdpl	150 mdpl
Type of tool	Ordinary (MRG)	Ordinary (MRG)	Ordinary (MRG)
Manager	PSDA Bondowoso	PSDA Bondowoso	PSDA Bondowoso
River Area	Baru Bajulmati	Baru Bajulmati	Baru Bajulmati
Village	Alas Buluh	Bajulmati	Sukorejo
Districts	Wongsorejo	Wongsorejo	Wongsorejo
Districts	Banyuwangi	Banyuwangi	Banyuwangi
Station Name	Alas Buluh	Bajulmati	Mailang
Station Code	180	182	182.A
South Latitude	-7,5811	-7,5632	-7,4739
East Longitude	114,2952	114,3743	114,3956
Elevation	550 mdpl	70 mdpl	65 mdpl
Type of tool	Ordinary (MRG)	Ordinary (MRG)	Ordinary (MRG)
Manager	PSDA Bondowoso	PSDA Bondowoso	PSDA Bondowoso
River Area	Baru Bajulmati	Baru Bajulmati	Baru Bajulmati
Village	Sukorejo	Alas Buluh	Wongsorejo
Districts	Wongsorejo	Wongsorejo	Wongsorejo
Districts	Banyuwangi	Banyuwangi	Banyuwangi

Then plotting the location of the rain station to the Bajulmati watershed map so that it can be seen which rainpoints affect the Bajulmati watershed. Calculation of effective rainfall is influenced by the extent of rain fall in the Bajulmati watershed recorded at the nearest rain station. Rain data obtained from each rain station uses daily rainfall data. The 10 daily rain data (3 periods) in one year (12 months) will be used to determine the 10 daily reliable discharge.

To calculate the average rainfall in the Bajulmati

watershed, the Polygon Thiessen Method is used. This method calculates the weight of each station that represents the area around it. In an area within a watershed it is assumed that rain is the same as that which occurred at the nearest station, so that the rain recorded at a station represents that area. With the uneven distribution of rain stations in the study area, this method is used. The following is the result of mapping the area of influence from the nearest station to the Bajulmati watershed, so that later stations will have an influence on the average rainfall in the Bajulmati watershed. The trick is to enter coordinate data from the 6 nearest rain station posts using the Autocad Assistance Program (Fig. 4) (Dinas PU SDA, 2017).

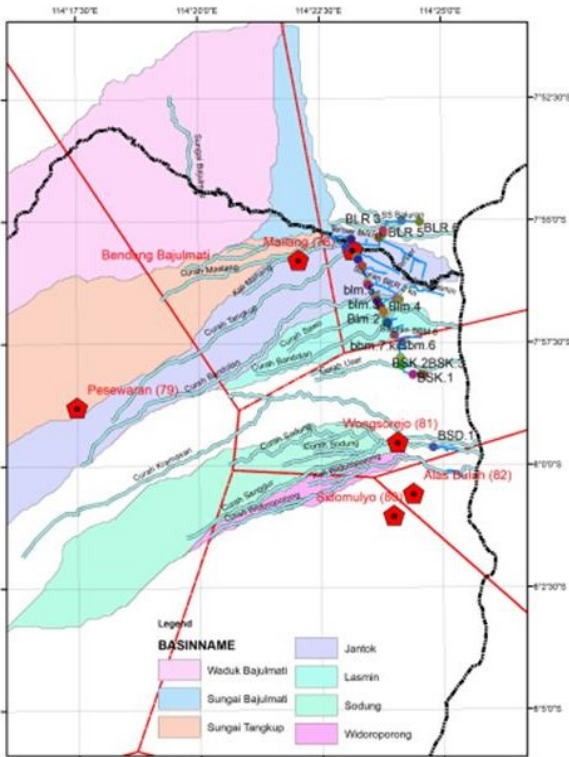

Fig. 4. Mapping Rain Station Posts to Bajulmati watershed map.

The step to find the area of influence is to connect the rain station with the polygon line. From there, obtained the area of the sub-area of each rain station which becomes an influence in the watershed that is limited by the heavy line on polygons. Based on the polygon thiessen images from the 6 rain stations that have been plotted, only 3 rain stations affect the Bajulmati watershed, namely the Bajulmati Rain Station Post, Mailang and Pasewaran. Rainfall data available at the three posts is daily rainfall data from 2008-2017. The data is then recapitulated into 10 daily rainfall data. Next, weighting factors are calculated from each rain station which represents the surrounding area. Examples of calculations using the Polygon Thiessen Method are as follows:

1. Find the area of each rain station post (A). From the results of plotting on Autocad, the area area of Aa (Pos Bajulmati Rain Station) = 24.93 km². The area of the Bajulmati watershed = 98.43 km².
2. Calculate the percentage weighting factor (W).

$$W = \frac{A_a}{A_{total}} \times 100\% = \frac{24,96}{98,43} \times 100\% = 25,00\%$$

Factors for other stations can be seen in Table II.

TABLE II. DATA OF POS RAIN STATION NEAR THE BAJULMATI WATERSHED

No.	Station Post Name	Area (km ²)	Weighting Factor (%)
1	Bajulmati Rain Station	24,93	25
2	Mailang Rain Station	29,50	30
3	Pasewaran Rain Station	44,00	45
Total		98,43	100

1. Calculate the average rainfall of the Polygon Thiessen Method. Calculation of average rainfall is to multiply the amount of rain each station with the weighting factor value of the station

Example of calculating average rainfall in January 2017 1st period:

The amount of rain in January for period 1 :

- a. Bajulmati Rain Station Station (Ra) = 29 mm
- b. Mailang Rain Station (Rb) = 157 mm
- c. Pasewaran Rain Station (Rc) Station = 167 mm

Then, multiplied by the weighting factors in Table III, obtained:

$$R = \frac{Ra.Wa + Rb.Wb + Rc.Wc}{100} = \frac{29.25 + 157.30 + 167.45}{100} = 129,05 \approx 129 \text{ mm}$$

Recapitulation of the average rainfall calculation results are shown in Table III.

TABLE III. RECAPITULATION OF CALCULATION RESULTS OF AVERAGE RAINFALL FOR 2008-2017

Years	Bulan											
	Jan	Feb	Mar	Apr	Mei	Jun	Jul	Agust	Sep	Okt	Nop	Des
2008	68	185	149	63	16	0	0	0	0	0	0	70
	42	43	69	1	0	0	0	0	0	0	0	216
	74	288	167	76	0	0	0	0	0	0	0	50
2009	209	27	9	0	3	3	0	0	0	0	0	0
	25	15	0	0	28	0	0	0	0	0	0	26
	32	14	0	0	11	0	0	0	0	0	0	16
2010	170	175	190	178	64	0	11	2	11	18	114	49
	64	57	69	190	110	0	8	17	33	0	137	
	325	72	15	95	18	0	31	0	2	9	13	109
2011	155	122	136	268	91	0	18	2	0	0	26	176
	87	36	122	40	20	0	17	11	0	0	10	175
	109	88	176	18	0	4	12	3	0	0	53	142
2012	110	168	153	26	1	0	0	0	0	0	0	31
	152	107	113	0	67	0	0	0	0	0	0	112
	94	97	101	28	37	0	0	0	0	0	0	86
2013	248	104	130	72	130	141	29	0	0	0	0	209
	153	179	192	63	192	107	28	0	0	0	50	257
	125	97	45	6	45	145	45	0	0	0	120	325
2014	177	114	97	193	35	0	74	0	0	0	0	86
	139	202	177	187	116	158	36	0	0	0	0	200
	389	184	181	119	115	0	0	0	0	0	0	236
2015	320	58	111	87	0	0	0	0	0	0	0	2
	390	41	121	92	0	0	0	0	0	0	0	48
	170	71	27	171	0	0	0	0	0	0	0	47
2016	40	73	158	11	10	28	93	0	1	129	29	187
	3	145	78	58	8	19	142	23	0	50	5	117
	137	120	62	9	5	97	6	17	5	19	40	229
2017	129	117	17	65	15	8	16	8	0	9	17	43
	143	178	36	11	1	43	7	0	0	10	86	145
	102	19	11	0	36	73	0	0	3	12	138	106
Q _{average} date 1-10	162,60	114,30	115,00	96,30	36,50	18,00	24,10	1,20	1,20	15,60	18,60	85,30
Q _{average} date 11-20	119,80	100,30	97,70	64,20	54,20	32,70	23,00	4,20	1,70	9,30	15,30	143,30
Q _{average} date 21-31	155,70	105,00	78,50	52,20	26,70	31,90	9,40	2,00	1,00	4,00	41,40	149,00

Debit Availability Analysis

Low flow discharge calculation using the F.J. Method. Mock The principle of this method has two approaches to

calculating surface runoff that occur in rivers, namely above ground water balance and underground water balance which are all based on rain, climate and soil conditions. Based on rain data and climatology data for 2008-2017, obtained the results of the calculation of available debits in the Bajulmati watershed for the years 2008-2017 shown in Table IV.

TABLE IV. RECAPITULATION OF CALCULATION OF DEBIT AVAILABILITY IN 2008-2017

No	Years	Januari			Februari			Maret			April		
		1	2	3	1	2	3	1	2	3	1	2	3
1	2008	12.751	6.248	4.973	8.352	3.808	11.903	8.469	5.013	7.744	4.414	1.408	3.377
2	2009	10.276	3.728	2.518	1.793	1.105	0.874	0.608	0.186	0.074	0.030	0.012	0.005
3	2010	6.518	3.910	13.185	9.718	4.900	4.282	8.283	4.679	2.019	7.295	8.848	5.875
4	2011	7.199	4.530	5.139	5.797	3.509	4.042	5.756	6.067	7.787	11.270	5.975	2.981
5	2012	7.205	7.801	5.644	7.900	6.056	5.355	7.186	6.100	5.457	2.511	0.847	1.356
6	2013	10.334	8.266	6.965	5.841	8.320	5.816	6.541	8.914	4.040	4.011	3.488	1.228
7	2014	10.596	8.272	16.800	8.522	10.163	9.622	6.290	8.463	8.985	9.608	9.549	7.066
8	2015	14.645	18.268	11.196	5.565	3.370	3.707	5.142	5.845	2.592	4.077	4.493	7.528
9	2016	2.041	0.683	5.293	3.964	6.508	6.150	7.540	4.913	3.794	1.541	2.685	1.059
10	2017	7.427	7.440	5.860	6.051	8.273	2.920	1.685	1.888	0.947	2.710	1.095	0.379

No	Years	Mei			Juni			Juli			Agustus		
		1	2	3	1	2	3	1	2	3	1	2	3
1	2008	1.479	0.492	0.197	0.079	0.031	0.013	0.005	0.002	0.001	0.000	0.000	0.000
2	2009	0.114	1.055	0.653	0.288	0.099	0.040	0.016	0.006	0.003	0.001	0.000	0.000
3	2010	4.115	5.308	2.096	0.730	0.292	0.117	0.459	0.115	1.188	0.351	0.410	0.117
4	2011	3.920	2.257	0.923	0.369	0.148	0.180	0.624	0.786	0.701	0.346	0.473	0.280
5	2012	0.406	2.644	2.015	0.577	0.231	0.092	0.037	0.015	0.006	0.002	0.001	0.000
6	2013	5.268	8.404	3.836	6.456	5.683	6.972	2.950	2.287	0.640	0.256	0.102	0.102
7	2014	3.404	5.434	5.711	1.576	6.472	1.615	3.384	2.236	0.671	0.269	0.107	0.043
8	2015	1.962	0.785	0.314	0.126	0.050	0.020	0.008	0.003	0.001	0.001	0.000	0.000
9	2016	0.725	0.514	0.355	1.127	0.965	3.864	4.385	6.438	1.923	0.732	1.153	0.946
10	2017	0.720	0.221	1.418	0.653	1.780	3.147	1.408	0.716	0.254	0.390	0.108	0.052

No	Years	September			Oktober			November			Desember		
		1	2	3	1	2	3	1	2	3	1	2	3
1	2008	0.000	0.000	0.000	0.000	0.000	0.000	0.000	0.075	1.866	3.032	8.749	9.350
2	2009	0.000	0.000	0.000	0.000	0.000	0.000	0.000	0.000	0.000	0.000	0.972	0.835
3	2010	0.445	0.746	0.277	0.776	1.430	0.715	4.435	1.073	0.911	2.077	5.588	5.402
4	2011	0.115	0.046	0.018	0.007	0.003	0.001	0.777	0.622	1.830	6.034	7.785	7.507
5	2012	0.000	0.000	0.000	0.000	0.000	0.000	0.017	0.004	0.002	1.137	4.398	4.229
6	2013	0.041	0.016	0.007	0.003	0.001	0.000	0.000	1.840	4.841	8.912	11.756	15.105
7	2014	0.017	0.007	0.003	0.001	0.000	0.000	0.000	0.000	0.000	3.168	8.124	10.722
8	2015	0.000	0.000	0.000	0.000	0.000	0.000	0.000	0.000	0.000	0.065	1.783	2.144
9	2016	0.311	0.118	0.234	4.818	2.964	1.582	1.580	0.651	1.703	7.355	6.105	10.186
10	2017	0.019	0.017	0.108	0.353	0.451	0.578	0.771	3.382	5.928	3.104	6.327	5.552

Reservoir Inflow Expansion

To obtain an estimate of the future reservoir inflow debit, the existing reservoir inflow discharge data series must be stretched forward. Random numbers are numbers that occur randomly. In this study random numbers are used in normal distribution with an average value = 0 and Standard Deviation = 1 resulting from Random Number Generation in the Excel program. The random number used is 36 numbers per year for 50 years for stretching reservoir inflow discharge. The random numbers that will be used in the calculations are shown in Table V and Table VI.

TABLE V. RANDOM NUMBERS FOR YEARS 1 TO 25

Year	1	2	3	4	5	6	7	8	9	10	11	12	13	14	15	16	17	18	19	20	21	22	23	24	25
2008	0.000	0.000	0.000	0.000	0.000	0.000	0.000	0.000	0.000	0.000	0.000	0.000	0.000	0.000	0.000	0.000	0.000	0.000	0.000	0.000	0.000	0.000	0.000	0.000	0.000
2009	0.000	0.000	0.000	0.000	0.000	0.000	0.000	0.000	0.000	0.000	0.000	0.000	0.000	0.000	0.000	0.000	0.000	0.000	0.000	0.000	0.000	0.000	0.000	0.000	0.000
2010	0.445	0.746	0.277	0.776	1.430	0.715	4.435	1.073	0.911	2.077	5.588	5.402	0.115	0.046	0.018	0.007	0.003	0.001	0.777	0.622	1.830	6.034	7.785	7.507	0.000
2011	0.115	0.046	0.018	0.007	0.003	0.001	0.777	0.622	1.830	6.034	7.785	7.507	0.000	0.000	0.000	0.000	0.000	0.000	0.017	0.004	0.002	1.137	4.398	4.229	0.000
2012	0.000	0.000	0.000	0.000	0.000	0.000	0.000	0.000	0.000	0.000	0.000	0.000	0.000	0.000	0.000	0.000	0.000	0.000	0.000	0.000	0.000	0.000	0.000	0.000	0.000
2013	0.041	0.016	0.007	0.003	0.001	0.000	0.000	0.000	1.840	4.841	8.912	11.756	15.105	0.000	0.000	0.000	0.000	0.000	0.000	0.000	0.000	0.000	0.000	0.000	0.000
2014	0.017	0.007	0.003	0.001	0.000	0.000	0.000	0.000	0.000	0.000	0.000	0.000	0.000	0.000	0.000	0.000	0.000	0.000	0.000	0.000	0.000	0.000	0.000	0.000	0.000
2015	0.000	0.000	0.000	0.000	0.000	0.000	0.000	0.000	0.000	0.000	0.000	0.000	0.000	0.000	0.000	0.000	0.000	0.000	0.000	0.000	0.000	0.000	0.000	0.000	0.000
2016	0.311	0.118	0.234	4.818	2.964	1.582	1.580	0.651	1.703	7.355	6.105	10.186	0.000	0.000	0.000	0.000	0.000	0.000	0.000	0.000	0.000	0.000	0.000	0.000	0.000
2017	0.019	0.017	0.108	0.353	0.451	0.578	0.771	3.382	5.928	3.104	6.327	5.552	0.000	0.000	0.000	0.000	0.000	0.000	0.000	0.000	0.000	0.000	0.000	0.000	0.000

TABLE VI. RANDOM NUMBERS FOR YEARS 25 TO 50

Year	1	2	3	4	5	6	7	8	9	10	11	12	13	14	15	16	17	18	19	20	21	22	23	24	25
2018	0.000	0.000	0.000	0.000	0.000	0.000	0.000	0.000	0.000	0.000	0.000	0.000	0.000	0.000	0.000	0.000	0.000	0.000	0.000	0.000	0.000	0.000	0.000	0.000	0.000
2019	0.000	0.000	0.000	0.000	0.000	0.000	0.000	0.000	0.000	0.000	0.000	0.000	0.000	0.000	0.000	0.000	0.000	0.000	0.000	0.000	0.000	0.000	0.000	0.000	0.000
2020	0.445	0.746	0.277	0.776	1.430	0.715	4.435	1.073	0.911	2.077	5.588	5.402	0.115	0.046	0.018	0.007	0.003	0.001	0.777	0.622	1.830	6.034	7.785	7.507	0.000
2021	0.115	0.046	0.018	0.007	0.003	0.001	0.777	0.622	1.830	6.034	7.785	7.507	0.000	0.000	0.000	0.000	0.000	0.000	0.017	0.004	0.002	1.137	4.398	4.229	0.000
2022	0.000	0.000	0.000	0.000	0.000	0.000	0.000	0.000	0.000	0.000	0.000	0.000	0.000	0.000	0.000	0.000	0.000	0.000	0.000	0.000	0.000	0.000	0.000	0.000	0.000
2023	0.041	0.016	0.007	0.003	0.001	0.000	0.000	0.000	1.840	4.841	8.912	11.756	15.105	0.000	0.000	0.000	0.000	0.000	0.000	0.000	0.000	0.000	0.000	0.000	0.000
2024	0.017	0.007	0.003	0.001	0.000	0.000	0.000	0.000	0.000	0.000	0.000	0.000	0.000	0.000	0.000	0.000	0.000	0.000	0.000	0.000	0.000	0.000	0.000	0.000	0.000
2025	0.000	0.000	0.000	0.000	0.000	0.000	0.000	0.000	0.000	0.000	0.000	0.000	0.000	0.000	0.000	0.000	0.000	0.000	0.000	0.000	0.000	0.000	0.000	0.000	0.000
2026	0.311	0.118	0.234	4.818	2.964	1.582	1.580	0.651	1.703	7.355	6.105	10.186	0.000	0.000	0.000	0.000	0.000	0.000	0.000	0.000	0.000	0.000	0.000	0.000	0.000
2027	0.019	0.017	0.108	0.353	0.451	0.578	0.771	3.382	5.928	3.104	6.327	5.552	0.000	0.000	0.000	0.000	0.000	0.000	0.000	0.000	0.000	0.000	0.000	0.000	0.000

The inflow discharge to the Bajulmati Reservoir comes from the Bajulmati River (upstream). 10 daily inflow discharge data is available from 2008-2017. The correlation coefficient is a measure of the relationship between two variables, which have values between -1 and 1. The closer to 1, the closer the perfect correlation. Signs of negative and positive values indicate an upward trend in the current trend compared to past inflows, or vice versa (negative correlation). The correlation coefficient in this study was calculated to determine the level of correlation of the reservoir inflow discharge for a period of 10 days against the previous period inflow.

This correlation coefficient is calculated based on historical data inflow for 10 years (2008-2017) using Eq.

$$R = \frac{\sum_{i=1}^n (X_i - \bar{X})(Y_i - \bar{Y})}{(\sum_{i=1}^n (X_i - \bar{X})^2)^{0.5} (\sum_{i=1}^n (Y_i - \bar{Y})^2)^{0.5}} \dots\dots\dots (1)$$

- R = correlation coefficient number
- X_i = data that existed before i (m3 / s)
- \bar{X} = average value of data before i (m3 / sec)
- Y_i = data available at i (m3 / sec)
- \bar{Y} = average value of data at time i (m3 / sec)

In carrying out future reservoir operational simulation patterns, one of the data required is the estimated reservoir inflow discharge. The method used in stretching the artificial periodic series in this study is to use the Markov model. The use of the Markov model because the series of periodic series data with added time (monthly) cannot be considered an independent variable, for example this month's discharge is very dependent on the debit of the previous month and maybe even the previous months. After all parameters needed for stretching forward inflow discharge are known, then an inflow discharge stretch calculation is calculated using the Markov model using Equation formula

$$X_{i,j} = X_j + R_j \frac{S_j}{S_{j-1}} (X_{$$

need for water for irrigation and excess water flowed through the spillway so that the discharge through the turbine depends on the need for irrigation water and the excess water flowed through the spillway. The needs of PLTMH follow the water needs for irrigation and excess water that is channeled through the spillway. The simulation results show that the availability of available water reaches an elevation of + 73.40 (minimum reservoir operation) or at a volume of 73.40 million m³ and cannot meet irrigation water requirements (irrigation water intake at 73.40 elevation) which occurs 110 times a period of 1,800 periods 10 daily. The average condition occurs in the period from August to November. From alternative simulation 1 describe the average annual electricity produced by PLTMH of 2,565 GWH / year if the turbine must be fully operational (alternative 1A) and 2,871 GWH / year if the turbine with 20% power production (P) is already operating (alternative 1B). The electricity production is higher than the current average production of 2.30 GWH (Indonesia Power, 2018). The highest electricity production that can be generated is 2,837 GWH / year in alternative 1A and 2,961 GWH / year in alternative 1B. The lowest annual electricity production occurred in the 43rd year of 2,491 GWH in alternative 1A and 2,832 GWH in alternative 1B. The simulation results show that the fulfillment of irrigation water needs (kT factor) is met with an average value of 2.47 with the highest kT factor value of 4.05 and the lowest average value of 1.55 that occurred in the 4th year.

In this alternative the simulation is carried out to meet the needs of irrigation (kT factor > 70%), the need for raw water and excess water that is channeled through the spillway is used to optimize the production of PLTMH by taking into account the availability of reservoir water. The simulation results show that the availability of water reaches an elevation of + 73.40 (minimum reservoir operation) or at a volume of 2.50 million m³ so that irrigation water needs cannot be met (kT factor < 70%) which occurs 176 times for a period of a total of 1,800 simulation periods. From these simulations obtained an illustration of electrical energy produced over 50 years is 3.046 GWH / year if the turbine must be fully operational (alternative 2A) and 3,046 GWH / year if the turbine when producing 20% of the maximum power is already operating (alternative 2B). This production is higher than alternative electricity production 1, thus showing that the second alternative is better because it can optimize electricity production. The highest electricity production from simulation results is 3.046 GWH / year, while the lowest is in the 4th year of 3.046 GWH in alternative 2A and 3,046 GWH in alternative 2B. Meeting the irrigation water needs (kT factor during the simulation year with an average value of 2.33. The lowest kT factor value occurred in the 4th year at 1.68 and the highest at 2.93. Furthermore, the results of the two simulation alternatives are used as comparative data in determining the best alternative that produces optimal output which is then used as a basis for making reservoir operation patterns.

b. Alternative Simulation 2 Fulfillment of kT Factor > 70%, Raw Water Needs and Optimizing the Production of Micro Hydro Power Plants.

1. Alternative Simulation 1 According to Current / Existing Reservoir Operations.

TABLE VII. EXAMPLE OF SIMULATION IN YEAR 1 (2018) ALTERNATIVE 1

Periode	Jumlah Hari	Tampung dan Waduk										PLTMH dan Release										Kondisi Akhir		Faktor k _T						
		ST _{ij}		Inflow _{ij}		Curah Hujan _{ij}		Evaporasi _{ij}		Vol. Real		Spillway		Vol. Efektif		Keb. Air Irigasi		Outflow		Supply		Turbine yang dapat bekerja			Turbine bekerja penuh		Turbine dengan 20% daya bekerja			
		10 ⁶ m ³	10 ⁶ m ³	mm	10 ⁶ m ³	mm	10 ⁶ m ³	10 ⁶ m ³	10 ⁶ m ³	10 ⁶ m ³	10 ⁶ m ³	10 ⁶ m ³	10 ⁶ m ³	10 ⁶ m ³	10 ⁶ m ³	10 ⁶ m ³	10 ⁶ m ³	10 ⁶ m ³	10 ⁶ m ³	10 ⁶ m ³	10 ⁶ m ³	10 ⁶ m ³	10 ⁶ m ³		10 ⁶ m ³	10 ⁶ m ³	10 ⁶ m ³	10 ⁶ m ³	10 ⁶ m ³	10 ⁶ m ³
1	2	3	4	5	6-5/100 (6x(7749 77/10 ⁶))	7	8-7/100 (8x(7749 77/10 ⁶))	9-3+4+6 8	10-9- (10,145)	11-9	12	13-12/10	14-13/ 60x(60x2 4)x2	15	16	17=mx(9 8)x(16x 0,66)x(3 3,60)x2	18=17x(24)	19	20=16x(0,66)	21=14-20	22	23=mx(9,8) x(22x(0,66) x(33,60)x2	24=23x(24)	25	26=22x(0,66)	27=14-26	28=11-13	29	30	
1	10	10.145	9.08195	162.66	0.126	39.113	0.030	19.323	9.178	10.145	1.676	1.676	1.940	2.94	2.00	3.477	83.453		1.32	0.62	2.00	3.477	83.453		1.32	0.62	8.47	84.50	1.00	
2	10	8.469	1.811	119.71	0.093	39.829	0.031	10.342	10.342	2.000	2.197	2.543	3.85	2.00	3.477	83.453		1.32	1.22	2.00	3.477	83.453		1.32	1.22	8.14	83.90	1.10		
3	11	8.145	6.163	155.60	0.121	42.238	0.033	14.395	4.250	14.395	1.016	5.266	5.541	8.40	2.00	3.825	91.798		1.32	4.22	2.00	3.825	91.798		1.32	4.22	9.13	86.74	5.18	
4	10	9.129	3.822	114.17	0.088	30.549	0.024	13.016	2.871	13.016	0.842	3.713	4.298	6.51	2.00	3.477	83.453		1.32	2.98	2.00	3.477	83.453		1.32	2.98	9.30	86.04	4.41	
5	10	9.303	5.431	100.28	0.078	30.549	0.024	14.788	4.643	14.788	1.081	5.724	6.625	10.04	2.00	3.477	83.453		1.32	5.31	2.00	3.477	83.453		1.32	5.31	9.06	85.60	5.29	
6	8	9.064	3.318	105.13	0.081	25.293	0.020	12.444	2.299	12.444	0.845	3.144	4.549	6.89	2.00	2.782	66.762		1.32	3.23	2.00	2.782	66.762		1.32	3.23	9.30	86.04	3.72	
7	10	9.300	9.432	115.00	0.089	41.168	0.032	18.789	8.644	18.789	1.350	1.562	2.37	2.00	3.477	83.453		1.32	0.24	2.00	3.477	83.453		1.32	0.24	17.44	101.09	1.00		
8	10	17.439	7.158	97.65	0.076	38.262	0.030	24.644	14.498	24.644	1.194	15.693	18.163	27.52	2.00	3.477	83.453		1.32	16.84	2.00	3.477	83.453		1.32	16.84	8.95	85.39	13.14	
9	11	8.951	11.901	78.58	0.061	46.883	0.036	20.877	10.732	20.877	3.357	3.357	3.532	5.35	2.00	3.825	91.798		1.32	2.21	2.00	3.825	91.798		1.32	2.21	17.52	101.24	1.00	
10	10	17.520	5.482	96.41	0.075	39.987	0.024	23.052	12.907	23.052	1.128	14.136	16.361	24.79	2.00	3.477	83.453		1.32	15.04	2.00	3.477	83.453		1.32	15.04	8.92	85.33	11.51	
11	10	8.917	3.181	64.23	0.050	28.678	0.022	12.126	1.980	12.126	3.370	5.350	6.192	9.38	2.00	3.477	83.453		1.32	4.87	2.00	3.477	83.453		1.32	4.87	6.78	81.37	1.59	
12	10	6.776	1.835	52.26	0.041	39.987	0.024	8.627	-	8.627	2.930	2.930	3.392	5.14	2.00	3.477	83.453		1.32	2.07	2.00	3.477	83.453		1.32	2.07	5.70	79.37	1.00	
13	10	5.697	2.407	36.60	0.028	29.929	0.016	8.116	-	8.116	2.181	2.181	2.524	3.82	2.00	3.477	83.453		1.32	1.20	2.00	3.477	83.453		1.32	1.20	5.94	79.81	1.00	
14	10	5.935	2.504	54.21	0.042	19.714	0.015	8.466	-	8.466	1.885	1.885	2.181	3.31	2.00	3.477	83.453		1.32	0.86	2.00	3.477	83.453		1.32	0.86	6.58	81.01	1.00	
15	11	6.581	1.275	26.72	0.014	21.685	0.017	7.860	-	7.860	1.878	1.878	1.976	2.99	2.00	3.825	91.798		1.32	0.66	2.00	3.825	91.798		1.32	0.66	5.98	79.90	1.00	
16	10	5.982	1.875	17.93	0.014	16.942	0.013	7.858	-	7.858	0.810	0.810	0.938	1.42	1.00	1.739	41.726		0.66	0.28	1.42	2.470	59.283		0.94	0.00	7.05	81.87	1.00	
17	10	7.048	1.393	32.68	0.025	16.942	0.013	8.453	-	8.453	1.167	1.167	1.350	2.05	2.00	3.477	83.453		1.32	0.03	2.00	3.477	83.453		1.32	0.03	7.29	82.31	1.00	
18	10	7.286	4.280	31.96	0.025	16.942	0.013	11.578	1.432	11.578	1.221	2.653	3.071	4.65	2.00	3.477	83.453		1.32	1.75	2.00	3.477	83.453		1.32	1.75	8.92	85.34	2.17	
19	10	8.924	3.903	24.17	0.019	16.579	0.013	12.833	2.688	12.833	1.304	3.992	4.620	7.00	2.00	3.477	83.453		1.32	3.30	2.00	3.477	83.453		1.32	3.30	8.84	85.19	3.06	
20	10	8.841	5.143	23.05	0.018	16.579	0.013	13.988	3.843	13.988	1.458	5.302	6.136	9.30	2.00	3.477	83.453		1.32	4.82	2.00	3.477	83.453		1.32	4.82	8.69	84.90	3.64	
21	11	8.687	2.650	9.43	0.007	18.236	0.014	11.330	1.814	11.330	1.499	2.684	2.824	4.28	2.00	3.825	91.798		1.32	1.50	2.00	3.825	91.798		1.32	1.50	8.65	84.83	1.79	
22	10	8.646	0.667	1.14	0.001	18.314	0.014	9.300	-	9.300	1.101	1.101	1.275	1.93	1.00	1.739	41.726		0.66	0.61	1.93	3.358	80.589		1.27	0.00	8.20	84.00	1.00	
23	10	8.198	0.367	4.21	0.003	18.314	0.014	8.554	-	8.554	0.963	0.963	1.115	1.69	1.00	1.739	41.726		0.66	0.46	1.69	2.938	70.502		1.12	0.00	7.59	82.88	1.00	
24	11	7.590	0.217	2.00	0.002	20.145	0.016	7.793	-	7.793	0.985	0.985	1.036	1.57	1.00	1.912	45.899		0.66	0.38	1.57	3.003	72.080		1.04	0.00	6.81	81.43	1.00	
25	10	6.808	0.133	1.18	0.001	23.983	0.019	6.924	-	6.924	1.022	1.183	1.79	1.00	1.739	41.726		0.66	0.52	1.79	3.117	74.809		1.18	0.00	5.90	79.75	1.00		
26	10	5.901	0.421	1.74	0.001	23.983	0.019	6.306	-	6.306	1.081	1.251	1.89	1.00	1.739	41.726		0.66	0.59	1.89	3.295	79.069		1.25	0.00	5.23	78.50	1.00		
27	10	5.235	0.055	1.01	0.001	23.983	0.019	5.262	-	5.262	1.135	1.314	1.99	1.00	1.739	41.726		0.66	0.65	1.99	3.460	83.042		1.31	0.00	4.13	76.47	1.00		
28	10	4.128	0.965	15.61	0.012	31.273	0.024	5.081	-	5.081	1.494	1.494	1.729	2.62	2.00	3.477	83.453		1.32	0.41	2.00	3.477	83.453		1.32	0.41	3.59	75.47	1.00	
29	10	3.587	0.578	9.28	0.007	31.273	0.024	4.148	-	4.148	1.456	1.456	1.685	2.55	2.00	3.477	83.453		1.32	0.37	2.00	3.477	83.453		1.32	0.37	2.69	73.82	1.00	
30	11	2.692	0.362	4.08	0.003	34.399	0.027	3.030	-	3.030	0.823	0.823	0.865	1.31	1.00	1.912	45.899		0.66	0.21	1.31	2.508	60.187		0.87	0.00	2.50	73.46	1.00	
31	10	2.500	1.618	18.61	0.014	37.504	0.029	4.103	-	4.103	0.802	0.802	0.928	1.41	1.00	1.739	41.726		0.66	0.27	1.41	2.444	58.651		0.93	0.00	3.30	74.95	1.00	
32	10	3.302	1.564	15.28	0.012	39.045	0.030	4.847	-	4.847	0.529	0.529	0.613	0.93																

1. Bajulmati Kiri (303 Ha) covers the Wonorejo Main Channel (303 Ha) located in Wonorejo Village, Banyuputih District, Situbondo Regency.
2. Right Bajulmati (516.60 Ha) covers the Bajulmati Main Channel (332.60 Ha) and Krajan Secondary Channel (184 Ha) located in Bajulmati Village, Sidodadi, Sumberkencono, Wongsorejo District, Banyuwangi Regency.

While the development plan DI. Bajulmati is as follows :

1. Bajulmati Left covers the Baluran Secondary Channel area of 170 Ha. So Bajulmati Left consists of Baluran Secondary Channels at 269 Ha and Wonorejo Main Channels at 204 Ha. So that the total area of the Left Bajulmati area is 473 Ha. Baluran Secondary Channels are distributed with the Wonorejo Main Channel along 825.65 m.
2. DI. Bajulmati Right covers the Sodung Secondary Channels (238 Ha), Kramasan Secondary Channels (379 Ha), Jantok Secondary Channels (238 Ha), Bajulmati Main Channels (44 Ha). So Bajulmati Right consists of Sodung Secondary Channels at 238 Ha, Kramasan Secondary Channels at 369 Ha, Jantok Secondary Channels at 238 Ha, Krajan Secondary Channels at 184 Ha and Bajulmati Main Channels at 288 Ha. So that the total area of Bajulmati Kanan is 1327 Ha. Krajan Secondary Channels are distributed with Bajulmati Main Channels. The water from Sayuti Dam is captured by Jantok Dam which is distributed by Bajulmati Main Channel and Jantok Secondary Channel. Water from the H. Usman Dam was captured by the Lasmin Weir which was distributed by the Bajulmati Main Channel. Water from the Lasmin Weir is distributed with Jantok Secondary Channels.

Reservoir Simulation Modeling

After calculating the availability of water / inflow obtained, average rainfall, the amount of evaporation, the plan for raw water requirements and PLTMH has been calculated, and the need for supletion from reservoirs for irrigation is known, then modeling of the reservoir operational simulation is carried out in order to obtain optimum reservoir operation. The following will explain in more detail the simulation modeling that will be carried out for each alternative.

1. Alternative Simulation Modeling 1
In this alternative the objective is to meet the needs of irrigation, by passing the irrigation water through PLTMH, PLTMH needs are also calculated from the excess water flowed through the spillway (PLTMH production depends on irrigation needs and excess water on the spillway). Release made by reservoirs on this alternative to meet 100% of irrigation needs.
2. Alternative Simulation Modeling 2
In alternative 2 the objective is to meet the needs of irrigation (kT factor > 70%), the need for raw water, increase the yield of PLTMH by optimizing PLTMH by flowing excess water on the spillway by considering the availability of water in the reservoir. Reservoir release decisions made on this alternative are the greatest value

between the discharge needed to meet 70% of irrigation needs and the discharge needed to drive 2 turbines.

V. CONCLUSIONS

1. The current reservoir operation pattern which only meets irrigation needs (kT factor = 100%), by passing irrigation water through a turbine, the average annual electricity generated is 2,300 GWH.
2. Simulation of reservoir operating patterns with stretching inflow discharge for the next 50 years is carried out with one condition of the operating pattern, with the conclusion of the simulation results as in the following description:
 - a. Alternative reservoir 1 operating patterns with operating conditions as they are today are priority fulfillment of irrigation needs (kT factor = 100% with differences in the way of calculating irrigation water requirements and excess water flowed through the spillway), the average annual electricity produced is 2,488 GWH (108.17% of the current condition) if the turbine must be fully operational (alternative 1A), and 2,796 GWH (121.57% of the current condition) if the turbine with 20% power production is operational (alternative 1B). Meeting the needs of irrigation water at this alternative (kT factor) 2.45.
 - b. Reservoir operation pattern with alternative 2, the operating conditions are the fulfillment of the lowest boundary irrigation requirements that can still meet (kT factor > 70%), raw water requirements, excess water flowed on the spillway flowed to optimize the MHP production by considering the availability of reservoir water, then the need raw water and irrigation water are met with an average fulfillment coefficient of 2.26 (kT factor > 70%). The average annual electricity generated is 2,823 GWH (122.74% of current conditions) if the turbine has to work fully (alternative 2A) and 2,852 GWH (124.00% of the current condition) if the turbine with 20% power production is already operate (alternative 2B).
 - c. From the analysis of simulation revenue results (without calculating costs) it can be concluded that the alternative that produces the highest income (farming and PLTMH) is alternative 1B of Rp. 338.69 billion, the next highest income is alternative 1A of Rp. 338.41 billion, the third highest alternative 2B of Rp. 313.03 billion and the lowest alternative income 2A was Rp. 313.00 billion. Assumptions in the calculation of irrigation water farming income are carried out simultaneously so that if the kT factor < 100% there is an area of land that is bero.
 - d. If the reservoir operation pattern is only on meeting the needs of 100% irrigation and excess water is flowed through the spillway, but does not pay attention to or optimize electricity production (PLTMH), then alternative operating patterns 1 can be carried out / continued. However, if the reservoir operation pattern is for optimizing PLTMH by fulfilling irrigation needs (kT factor > 100%), meeting the needs of raw water and excess water flowed through the spillway, then the alternative reservoir operating pattern 2 can be used.

REFERENCES

- Dinas PU SDA, (2017), Data Station Rain Rain Near the Bajulmati watershed.
- Suharyanto. 1997. Analysis of Reservoir Operation Performance. Civil Engineering Communication Media, Edition VIII. Semarang.
- Afifah, Nailil, (2013), Optimizing the Operational Pattern of the Wadaslintang Reservoir, Master's Thesis, Sepuluh Nopember Institute of Technology, Surabaya.
- Mays, L. W., (1996), Water Resources Handbook, hal. 6.16 – 6.36, McGraw-Hill, New Jersey.

Test of Concentration and Dosage of Fruit Organic Waste Extract on the Growth and Yield of Broccoli (*Brassica oleracea*) Plants

Dyah Roeswitawati

Agrotechnology, Faculty of Agriculture
Muhammadiyah University of Malang
Malang, Indonesia
dyroeswita@yahoo.com

Abdul Malik

Agrotechnology, Faculty of Agriculture
Muhammadiyah University of Malang
Malang, Indonesia
maliq394@gmail.com

Aniek Iriany

Agrotechnology, Faculty of Agriculture
Muhammadiyah University of Malang
Malang, Indonesia
aniek55@yahoo.com

Abstract— Broccoli (*Brassica oleracea*) has a prospect to be developed in Indonesia because it is a source of vitamin A, B complex, C, ascorbic acid, thiamin, riboflavin, calcium, iron, and minerals essential for the fulfillment of human nutrition. Organic waste that has undergone a fermentation process can be used by plants as liquid organic fertilizer and at the same time can be utilized by plants as a stimulant to grow. The aim of the study was to examine the relationship of the dose and concentration of extract of fruit organic waste to the growth and yield of broccoli. The research was carried out on the integrated land of the Faculty of Agriculture-Animal Husbandry, Muhammadiyah University of Malang from February to May 2018. The study was a factorial experiment arranged in a randomized block design and repeated 4 times. The first factor is the concentration of fruit organic waste extract, namely K1: 50 cc / l; K2: 100 cc / l; K3: 150 cc / l. The second factor is the dose of fruit organic waste extract, namely: D1: 50 ml /plant; D2: 100 ml /plant. Observation parameters include plant height, number of leaves, stem diameter, flower diameter, flower weight, wet weight, dry weight. Data were analyzed using Fisher's test, then tested using BNJ 5% test. The results showed no interaction between the concentration and dosage of fruit organic waste extract on the growth and production of broccoli plants. There is a positive correlation between each observed variable. The best concentration of fruit organic waste extract is 100 cc / l. The best dose of fruit organic waste extract is 50 ml /plant

Keywords— *broccoli, fruit, dosage, concentration, waste, organic*

INTRODUCTION

Broccoli (*Brassica oleracea*) has a prospect to be developed in Indonesia because it is a source of vitamin A, B complex, C, ascorbic acid, thiamin, riboflavin, calcium, iron and minerals essential for the fulfillment of human nutrition and contains sulforaphane which can prevent cancer, besides helps digestion, neutralizes acid and does not contain cholesterol [1]; [2]. The amount of vitamin content found in broccoli, makes the demand for broccoli in the market has increased by 15-20% per year [3]. However, the high demand is not balanced with adequate quality and quantity of production [4]. One of the causes of the decreasing quality and quantity of broccoli production is the continuous use of

inorganic fertilizers [5]. Provision of inorganic fertilizers or chemical fertilizers for a long time can cause soil damage in physics, biology, and chemistry. Plant organic waste is the raw material for the fermentation process of soil microbes which are useful for increasing the quantity and quality of crop production and maintaining environmental sustainability [6]. Organic waste that has undergone a fermentation process can be used by plants as liquid organic fertilizer and at the same time can be utilized by plants as a stimulant to grow. The fruit is rapidly damaged (perishable) by mechanical, chemical and microbiological influences, making it easy to rot. Very high water content in fruit can stimulate enzyme and microbial activity that causes damage easily [7]. The aim of the study was to examine the relationship of the dose and concentration of extract of fruit organic waste to the growth and yield of broccoli

MATERIALS AND METHODS

This research was conducted in the integrated land of the Faculty of Agriculture-Animal Husbandry, University of Muhammadiyah Malang from February to May 2018. It was a factorial experiment arranged randomly in groups, the first factor was the concentration of fruit waste extract: K1 = 5% (50 ml / l); K2 = 10% (100 ml / l); K3 = 15% (150 ml / l). The second factor are the dose of fruit waste extract: D1 = 50 cc/plant, and D2 = 100 cc/plant.

The fruit waste extraction process is carried out after the fermentation process of the ingredients as follows: 1 kg of fruit is crushed and then mixed with 300 ml molasses and leri water, 5 liters is then fermented for 21 days. After the fermentation of the mixture is filtered, the filtrate is evaporated using an evaporator 30o C for 1 hour. Broccoli seeds to be sown are selected and then soaked in water for ± 12 hours to quickly germinate, then seed in the seedling tray, each tray hole filled with 1 seed of the broccoli. A month later broccoli seeds were moved to beds with a spacing of 50x50 cm. after the age of 2 weeks after the transplanting was given an extract of fruit waste according to treatment. Observations were made on the number of leaves, flower diameter, wet weight of flowers, plant wet weight

The data obtained were analyzed using the Fisher (ANOVA) test. If there is a difference, to compare the effect between treatments then a further test using a BNJ test of 5% is carried out

RESULT AND DISCUSSIONS

Number of Leaves

The results of the variance analysis showed that there was no real interaction between the treatment of concentration and dosage of the extract of fruit organic waste against the number of broccoli leaves. Each concentration treatment and dosage treatment did not show any real differences. The average number of broccoli leaves in each concentration treatment and dosage treatment of fruit organic waste extract are presented in Figure 1.

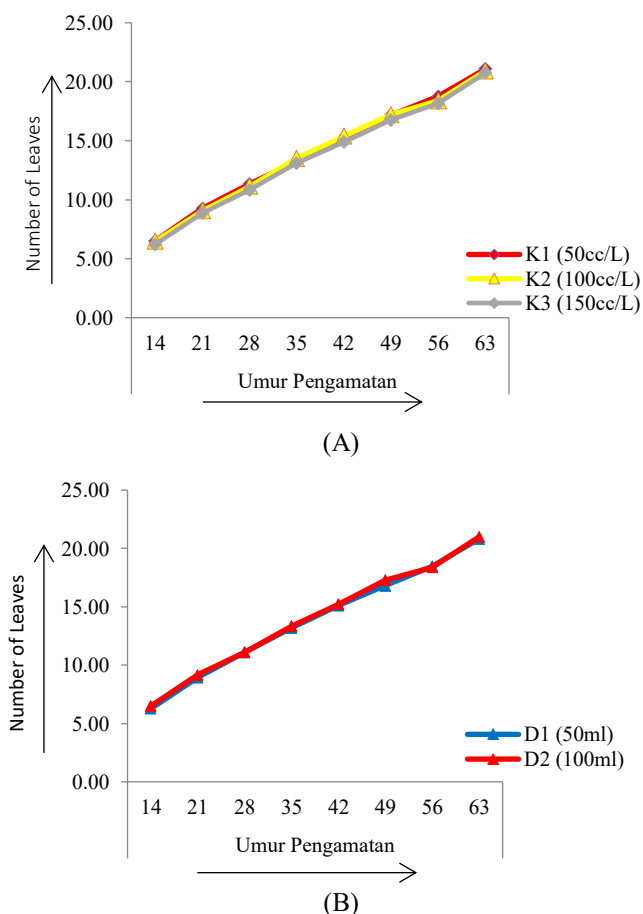

Fig. 6. Mean of number of broccoli leaves in each concentration treatment (A) and dosage treatment (B) of fruit organic waste extract

In Figure 1 above, it appears that the higher the concentration of fruit organic waste given is followed by the increase in the number of broccoli leaves (Figure 2A), as well as the given dose, namely the higher the dose of organic fruit waste given followed by the increase in the number of broccoli leaves (Figure 2B).

Flower Diameter

The results of the variance analysis showed that there was no real interaction between the treatment of concentration and dosage of extract of fruit organic waste to the flower diameter. Each concentration treatment and dosage treatment did not show any real differences. The average flower diameter in each

concentration treatment and dosage treatment of fruit organic waste extract are presented in Figure 2

In Figure 2 it appears that the concentration of organic waste is good for the diameter of broccoli flowers is 100 ml / l (Figure 2A), and the good fruit waste dose for broccoli flowers is 50 cc / plant (Figure 2B).

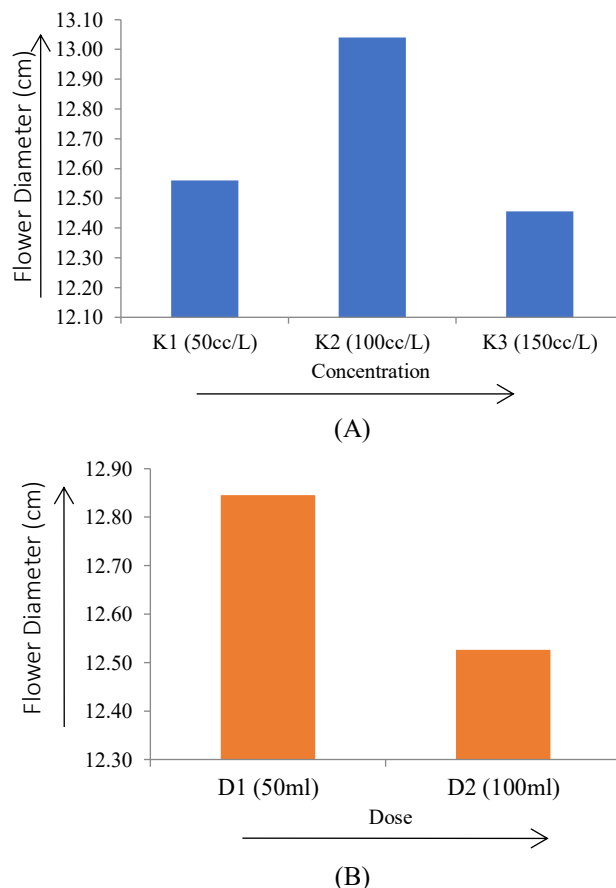

Fig. 7. Mean of flower diameter in each concentration treatment (A) and dosage treatment (B) of fruit organic waste extract.

In Figure 2 it appears that the concentration of organic waste is good for the diameter of broccoli flowers is 100 ml / l (Figure 2A), and the good fruit waste dose for broccoli flowers is 50 cc / plant (Figure 2B).

Weight of Flower

The results of the variance analysis showed that there was no real interaction between the treatment of concentration and dosage of extract of fruit organic waste to weight of flower. Each concentration treatment and dosage treatment did not show any real differences. The average weight of flower in each concentration treatment and dosage treatment of fruit organic waste extract are presented in Figure 3.

In Figure 3 it appears that the concentration of organic waste is good for the weight of broccoli flowers is 100 ml / l (Figure 3A), and the good fruit waste dose for weight broccoli flowers is 50 cc / plant (Figure 2B).

Wet Weight of Plant

The results of the variance analysis showed that there was no real interaction between the treatment of concentration and dosage of extract of fruit organic waste to wet weight of plant.

Each concentration treatment and dosage treatment did not show any real differences. The average wet weight of plant in

each concentration treatment and dosage treatment of fruit organic waste extract are presented in Figure 4.

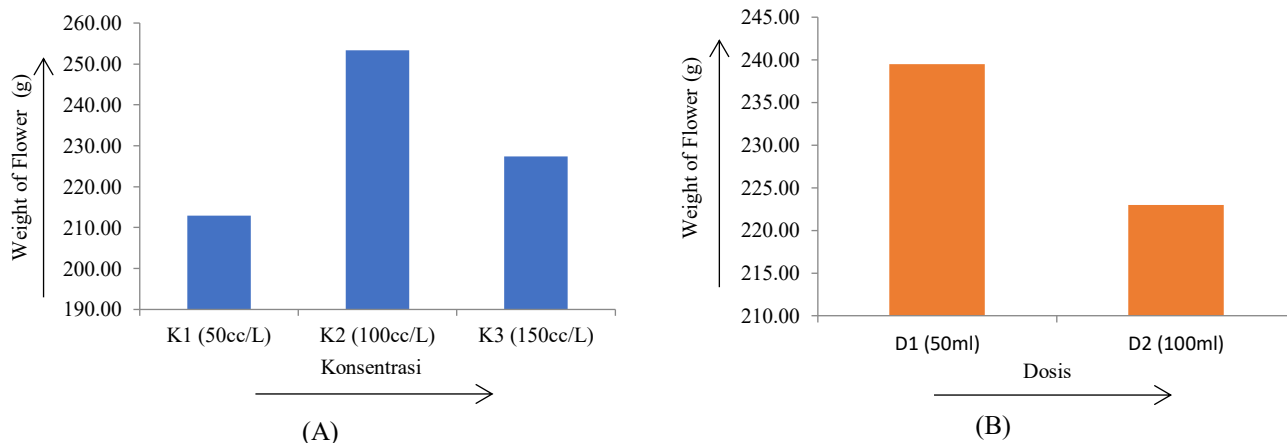

Fig. 8. Mean of weight of flower in each concentration treatment (A) and dosage treatment (B) of fruit organic waste extract

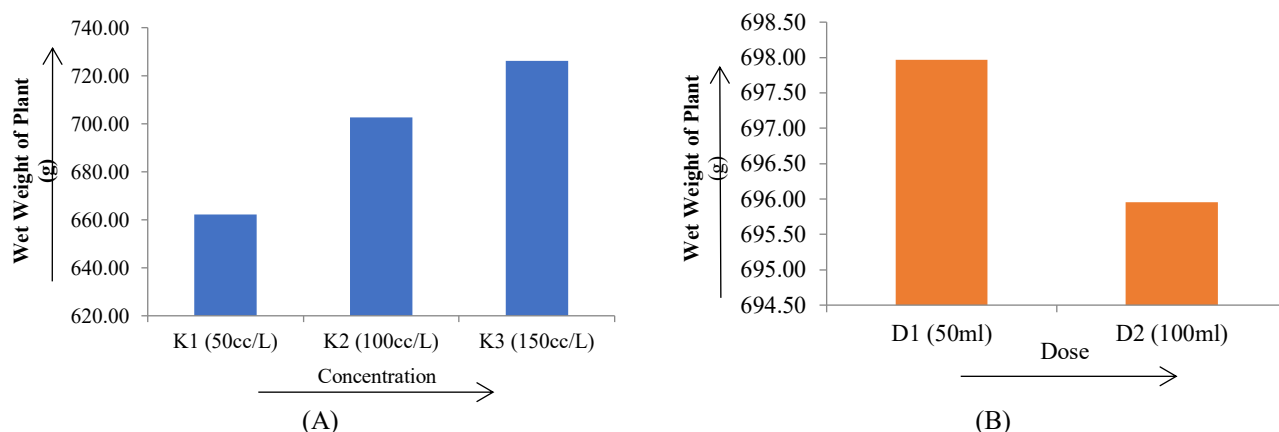

Fig. 9. Mean of wet weight of plant in each concentration treatment (A) and dosage treatment (B) of fruit organic waste extract

In Figure 4 it appears that the concentration of organic waste is good for the wet weight of plant is 100 ml / l (Figure 4A), and the good fruit waste dose for wet weight of plant is 50 cc / plant (Figure 2B).

Inter-Variable Correlation

There is a positive correlation between these variables which is indicated by an increase in one of the variables followed by an increase in the results of the comparison variable, which is indicated by the correlation coefficient. Correlation coefficients between variables are presented in Table 1

In Table 1 it appears that the correlation coefficient value between variables shows that the calculation results are close to +1, so the correlation relationship is positively correlated. This shows that every increase in one variable will be followed by an increase in the results of the comparison variable. The variable that has a very close relationship is the diameter of the flower with the weight of interest, namely the value of the person correlation (r) + 0.952 and p value 0,000 (p <0.05). This shows that the flower diameter and

flower weight are positively correlated and very strong or close to +1. The P value is 0,000 (p <0.05), which means that it indicates the closeness of the relationship between the diameter of the flower and the weight of the flower, the greater the diameter of the flower, the higher the yield of the weight of the flower.

TABLE I. INTER-VARIABLE CORRELATION COEFFICIENTS BROCCOLI

	PH	NL	SD	FD	FW	PW
NL	0,275					
	0,193					
SD	0,819	0,492				
	0,000	0,015				
FD	0,801	0,495	0,797			
	0,000	0,014	0,000			
FW	0,816	0,548	0,844	0,952		

	0,000	0,006	0,000	0,000	
PW	0,648	0,444	0,826	0,745	0,715
	0,001	0,030	0,000	0,000	0,000
DW	0,442	0,300	0,581	0,534	0,485
	0,031	0,155	0,003	0,007	0,016
				0,000	

Notes : PH : Plant Height, NL : Number of leaves, SD : Steem Diameter, FD : Flower Diameter, FW : Flower Weight, PW : Plant Weight, DW : Dry Weight

■ = Correlation Coefficient, ■ = P Value

Nutrient Analysis of Nitrogen, Phosphorus and Potassium

Based on the assay test the macro nutrient content of Nitrogen, Phosphorus, and Potassium fruit organic waste that has been carried out is presented in Table 2.

TABLE II. THE MACRO NUTRIENT CONTENT OF NITROGEN, PHOSPHORUS, AND POTASSIUM FRUIT ORGANIC WASTE (%).

Sample	Fruit Organic Waste
N-Organic	0,063
N-NH ₄	0,007
N-NO ₃	0,000
N-Total	0,07
P	0,0047
K	0,189

Table 2 shows that the highest nutrient content of organic fruit waste is potassium, which is 0.189%, while nitrogen content includes N organic and N ammonium, there is no nitrate. The level of phosphorus is only 0.0047%.

DISCUSSION

The results of the variance analysis showed that there was no interaction between the concentration and dosage of fruit organic waste on the parameters of growth and production to broccoli plants. The best concentration for growth and yield to broccoli are 100 ml / l, and the best dose for growth and yield of broccoli are 50 cc / plants. This is in accordance with the results of [8] that the concentration of 75 ml/liter of mango fruit waste can increase the growth and yield of beans, where the composition is 10 kg of rotten mango mixed with 1 liter of coconut water and 2 kg of palm sugar then fermented.

There is a positive correlation between these variables which is indicated by an increase in one of the variables followed by an increase in the results of the comparison variable. For example the relationship between plant height and flower weight (r = 0.816), the relationship between flower weight and flower diameter (r = 0.952). Growth and development are the results of interactions between internal factors (genetic traits) and external factors (environment including nutrients). The value of plant growth rate is a sign of growth characteristics both in size, shape, and volume. Plant biomass is the measure most often used to describe and study plant growth and is a representative indicator of the overall appearance of certain plants or organs. Plant growth

rate describes the addition of plant weight per unit time. If the availability of nutrients is not optimal, plants will show symptoms of deficiency and sources of plant nutrients derived from inorganic and organic materials [5].

Nutrients Nitrogen contained in fruit organic waste is less than unsure Potassium which is presented in Table 2, while in the growth phase it takes higher N elements. Wasonowati, C. (2009) states that adequate nitrogen addition can stimulate good vegetative growth so that generative growth is also good so it will cause plants to flower in time. If during the growth of broccoli plants experience a deficiency of N elements, there will be a delay in maturation of flower mass (crop), loss of yield, and decreased quality of broccoli plants. Environmental factors also affect the growth of broccoli plants, broccoli generally is not resistant to heat and is able to adapt well to cold or cool climate with low air humidity. A temperature of less than 23 oC is needed to stimulate the formation of flowers [5]. Broccoli is not resistant to high rainfall because it will cause this plant to become yellowish. Rainfall is ideal for broccoli growth between 1000-1500 cm per year [9]. The observation of wet weight and dry weight of broccoli plants showed no real interaction, this is because the nutrients contained in fruit organic waste were not fulfilled for broccoli plants [11]; [12]. The wet weight of plants reflects balanced soil fertility, nutrients can be absorbed by plants well but if the soil lacks one nutrient such as nitrogen, photosynthesis is not perfect and the process of translocation of carbohydrates is not smooth[10] . As a result, carbohydrates are formed only in the leaves, so that it will cause the weight of plant organs above the surface of the soil and reduce the harvest index. Translocation efficiency is a value that shows how much proportion of the accumulated results in the leaves are translocated to the storage portion of food reserves such as tubers, seeds and parts consumed rather than to the vegetative part to form new leaves, branches and roots. This value further shows how the dominance of vegetative growth in a plant is compared to its generative growth

CONCLUSION

There is no interaction between the concentration treatment and the dosage treatment of extracts of fruit organic waste on the growth and yield of broccoli. There is a positive correlation between each observed variable. The concentration of fruit organic waste extract suitable for the growth and yield of broccoli is 100 cc / l with a dose of 50 ml/plant

ACKNOWLEDGEMENTS

We gratefully acknowledge to University of Muhammadiyah Malang, East Java, Indonesia for supporting us in providing research funds to seminars and conferences

REFERENCES

[1] Wasonowati, C. (2009) *Kajian Saat Pemberian Pupuk Dasar Nitrogen dan Umur Bibit Pada Tanaman Brokoli (Brassica oleraceae var. Italica Planck). Agrovigor*, 2, 14–22. <http://neobis.trunojoyo.ac.id/agrovigor/article/view/236>

[2] Gad, N., & El-moez, M. R. A. (2011) Broccoli growth , yield quantity and quality as affected by cobalt nutrition. *Agriculture and Biology Journal of North*

- America, 2(2), 226–231. <https://doi.org/10.5251/abjna.2011.2.2.226.231>
- [3] Riwanti, W. 201. *Manajemen Rantai Pasokan Brokoli Organik (Studi Kasus Agro Lestari di Cibago, Kabupaten Bogor, Jawa Barat)*. Bogor: IPB.
- [4] Farnham, M. W., & Björkman, T. (2011). Evaluation of experimental broccoli hybrids developed for summer production in the Eastern United States. *HortScience*, 46(6), 858–863. <https://doi.org/10.5772/45866>
- [5] Rochman, A. S., Suryanto, A., & Sugito, Y. (2017) *Pengaruh Dosis Pupuk Kandang dan Varietas Pada Hasil Tanaman Brokoli (Brassica oleracea L. Var. Italica)*. *Jurnal Produksi Tanaman*, 5(8), 1250–1256. <http://protan.studentjournal.ub.ac.id/index.php/protan/article/view/501>
- [6] Danuji, S. (2017). Pemanfaatan Mikroorganisme Lokal Mempercepat Kelestarian Lingkungan Akibat Konversi Lahan Produktif Menjadi Perumahan. Seminar Nasional Biologi, IPA dan Pembelajarannya (pp. 1–14). Universitas Muhammadiyah Jember: 12 April 2017. <http://jurnal.unmuhjember.ac.id/index.php/PB2017/article/viewFile/944/753>.
- [7] Dewi, S. E. 2014. *Perbandingan kadar vitamin C, organoleptik, dan daya simpan selai buah tomat (Lycopersicum esculentum) dan pepaya (Carica papaya) yang ditambahkan gula pasir*. Fakultas Keguruan dan Ilmu Pendidikan Surakarta Universitas Muhammadiyah Surakarta, Surakarta.
- [8] Zulputra, & Hidayat, T. (2018). espon Tanaman Kacang Panjang (*Vigna sinensis* L.) Terhadap Pemberian Pupuk Organik Cair Mikroorganisme Lokal Buah mangga. *Sungkai*, 6(1), 50–59. <http://e-journal.upp.ac.id/index.php/sungkai/article/view/1523>.
- [9] Dalmadi. 2010. Syarat Tumbuh Brokoli. Kementerian Pertanian Badan Penyuluhan dan Pengembangan Sumber Daya manusia Pertanian. Jakarta: Direktorat Jenderal Holtikultura
- [10] USDA Nutrient Database. 2011. Broccoli Raw. <http://nal.usda.gov> Diakses 8 Januari 2018
- [11] Sembiring, S., & Karo-Karo, A. (2017). Respon Pertumbuhan dan Produksi Tanaman Brokoli (*Brassica oleracea* var. Brotytis L) Terhadap Pemberian Pupuk Organik Padat dan Jarak Tanam. *Jurnal Agroteknosains*, 01, 23–36. <http://www.portaluniversitasquality.ac.id:5388/ojsystem/index.php/AGRO TEKNO SAINS/article/download/28/29>.
- [12] Handayani, S. H., Yunus, A., Susilowati, A. (2015). Uji Kualitas Pupuk Organik Cair dari Berbagai Macam Mikroorganisme Lokal (MOL). *Jurnal EL-VIVO*, 3(1), 55–56. <http://jurnal.pasca.uns.ac.id>

Impact of Wild Cicer Species on Production under Climate

Amar Ma'ruf
Faculty of Agriculture
University of Asahan
North Sumatra, Indonesia

Faculty of Agriculture
Akdeniz University
Antalya, Turkey
amarsanis92@gmail.com

Duygu Sari
Faculty of Agriculture
Akdeniz University
Antalya, Turkey
dsari@akdeniz.edu.tr

Tuba Eker
Faculty of Agriculture
Akdeniz University
Antalya, Turkey
ekertuba07@gmail.com

Hatice Sari
Faculty of Agriculture
Akdeniz University
Antalya, Turkey
hsari@akdeniz.edu.tr

Cengiz Toker
Faculty of Agriculture
Akdeniz University
Antalya, Turkey
tokert@akdeniz.edu.tr

Abstract— Chickpea (*Cicer arietinum* L.) is mostly grown in marginal areas under rainfed conditions in the world, and it is exposed to high temperature and drought stresses. Extreme temperature in the near future has been predicted to increase due to climate change that caused to take place high temperature and drought stresses. Therefore, it is necessary to release cultivars to be resistant to high temperature and drought stresses to maintain stable production of chickpea. *C. pinnatifidum* and *C. reticulatum* have been shown to be tolerant to heat and drought stress. Perennial wild *Cicer* species including *C. anatolicum*, *C. microphyllum*, *C. montbretti*, *C. oxydon* and *C. songaricum* were found to be tolerant drought. Although perennial wild *Cicer* species have been shown to be significantly tolerant to drought stress, only two *Cicer* species can be crossed with the cultivated chickpea. To overcome these stresses, all *Cicer* species should be used in a long-term breeding program to produce chickpea cultivars that are tolerant to high temperature and drought stresses.

Keywords: chickpea, wild *Cicer* species, breeding, climate change

INTRODUCTION

Legumes are an important source of protein for humans [1,2] and animal feed [3]. One of the most consumed legumes is chickpea (*Cicer arietinum* L.). Chickpea is the first rank among cool-season legumes on the base of sowing area. In 2016, chickpea is grown by around 14.5 million hectares produced 14.7 million metric tons [4]. The annual yield of chickpea is considered to be lower than its potential yield [5] since about 90% of chickpea in the world are grown in rainfed conditions [6]. The crop is mostly grown in the world under marginal conditions where terminal drought is a limiting factor of productivity [7]. In Northern Australia and South Asia, chickpea is predominantly cultivated after the rainy season characterized by residual moisture in the soil [8]. In the Mediterranean region, Central Asia, West Asia and North Africa, chickpea is traditionally sown at the end of spring rainfall and grown in stored available moisture during the winter and early spring rainfall. In both environments, chickpea is subjected to the increased temperatures, decreased soil moisture, and vapor pressure deficits during flowering and maturity [5, 8, 9]. It has been observed that there was a decrease in chickpea yielding 53 kg per ha every increase in temperature of 1 °C in seasonal temperature [10]. A significant

correlation between drought susceptibility index and seed yield, harvest index and mean productivity, and biological yield in drought stress environment was reported by [11].

Extreme temperature in the near future has been predicted to increase due to climate change that caused to take place high temperature and drought stresses. Climate change is a major obstacle to the production and productivity of chickpea. The negative impacts of climate change such as drought, temperature changes, and excessive moisture that affect crop yield in many regions globally [12]. To reduce the impact of climate change on the yield of chickpea, it is very important to produce new varieties for resistance to biotic and abiotic stresses. Plant breeders rely on genetic resources to create new varieties that have higher resistance to biotic and abiotic stresses. Unlike cultivated chickpea, wild *Cicer* species are referred to as a good source of resistance to multiple stresses [13]. A total of 49 taxa including 40 perennial wild *Cicer* and nine annuals with cultivated chickpea was listed [14]. Wild relatives of chickpea have been shown to be more tolerant to drought stress [13]. Recognizing the negative effects of climate change has an effect on increasing temperatures and causing drought stress on chickpea. On the other hand, wild *Cicer* species as genetic sources have the potential to improve resistance to high-temperature and drought stress. Thus, this article includes the interplay of high-temperature and drought stress in chickpea, and breeding strategies using wild *Cicer* to increase tolerance to high-temperature and drought stress in chickpea.

EFFECTS OF CLIMATE CHANGE ON CHICKPEA

Since 1901, the earth has warmed around 0.7-0.9 °C per century, but since 1975, the increase in temperature has nearly doubled to an average of 1.5-1.8 °C per century.

Indirect effects of climate change consist of heat, drought, flood, soil fertility, plant disease, rise in sea level and irrigation availability, while direct effects include changes in morphology, physiology, phenotype and crop productivity [15]. Generally, there are three main causes of drought, including land and sea surface temperatures, atmospheric circulation patterns and soil water content [16, 17]. Higher temperatures encourage an increase in water pressure deficits that are expected to increase demand for atmospheric

evaporation [18]. Researchers who use global climate models find that there is an increase in evaporation of water when the average surface temperature rises leading to more extreme weather events [19].

On the field circumstance, heat and drought are the most dominant stresses that have a significant effect on plants [20]. Due to climate change, extreme temperature and water deficit affect the reproductive phase of plant growth [21]. As heat stress affects yield and grain production, cold stress results in sterility, and drought stress negatively affects plant morphophysiology [22, 23].

Heat Stress

In plants, high-temperature stress results in the collection of reactive oxygen species (ROS) to be excessive and rapid. Under stressful conditions, ROS directly reacts with proteins, lipids and nucleic acids which cause membrane injury mediated lipid peroxidation, enzyme inactivation, protein degradation, disruption of DNA strains, and bleaching of pigments [24].

Temperature changes affect the grain yield of chickpea, especially in physiological and developmental processes. In the physiological process means a decrease in photosynthetic efficiency, loss of carbon gain, and weakening of assimilate translocations [25]. At the reproductive stage, high temperatures suppress maturity and poor biomass in chickpea (Clarke and Siddique, 2004).

Chickpea has profligate loss of flower buds and flower opening at high temperatures >30 °C [27]. At the stage of reproductive development, heat stress (>35 °C) causes pollen sterility. The high-temperature stress affects the function of male reproductive tissue (anther and pollen) and pot set. Anther abnormalities and pollen sterility occur, thinning of the anther epidermal wall, and changes in the number of anther locule [28].

Heat stress affects the heat tolerance index [29]. In enzymatic reactions, heat stress causes a decrease in enzyme activity (rubisco, sucrose synthesizing enzyme, sucrose phosphate synthase) [30]. Heat stress in chickpea affects the harvest index and number of pods per plant [29].

Drought Stress

Drought stress affects chickpea at all stages of growth drastically. Drought stress affects biochemical, morphological, physiological, molecular, and phenological traits, yield and yield components, nodule formation, and nitrogen uptake [31].

Drought stress decreases chlorophyll content (a and b) and resultantly decreases light harvest capacity [32]. Possible due to a decrease in nitrate reductase activity [33], because one of the functions of the nitrate reductase enzyme plays a role in the formation of chlorophyll [34]. Chlorophyll degradation is also caused by increasing leaf temperature [35].

Drought stress causes changes in most morphological aspects of chickpea. When chickpea plants are exposed to drought stress, the dry weight of stem, root, leaves and dry matter per plant decreased [9, 36]. Roots in chickpea exposed to drought stress were pointed out to be increased in length and dry weight, while the leaves and leaflets decreased in length and width [37]. Plant height was also reported to be decreased [38].

Micronutrient contents including N, P, K, Ca, Mg, Fe, Zn, Mn and B were reported to be decreased [39], while the proline content was increased [32]. Proline amino acid concentrations in plants was found to be increased under water-deficient conditions [40]. Drought stress in chickpeas inhibits the formation of nodulation in the roots. The percentage of empty nodule numbers was increased, and then specific N-fixation decreased [41].

Drought stress affects the phenological traits and yield of chickpea. Chickpea exposed to drought stress is resulted in reduce in the duration of the vegetative and reproductive phases. These changes result in changes in the duration of pod filling and seed size [37, 38, 42]. Flowering and pod formation (reproductive phase) are the most susceptible due to drought stress [43]. Chickpea losses yield tremendously (50-100%) due to drought stress [9, 44]. The number and size of pods were decreased by drought [45].

UTILIZATION OF WILD *CICER* AS A BREEDING STRATEGY

Genetic Researces of Heat and Drought Resistance

Currently, both association mapping and linkage analysis are used for genetic dissection of the complex trait of chickpea [46]. Mapping traits or genes identified for tolerance to drought stress in chickpea were listed in Table 1.

Quantitative trait loci (QTLs) have been identified regarding heat tolerance in chickpea (Paul et al., 2018) using 292 F8-9 recombinant inbred lines (RILs) which were developed from crossings between ICC 4567 (heat sensitive) x ICC 15614 (heat tolerant). The results of QTL identification are shown in Table 2.

Breeding for Heat and Drought Stress Resistance

Wild *Cicer* species have a resistant source for different biotic and abiotic stresses [13, 47, 48, 49, 50, 51, 52, 53, 54, 55].

Under field conditions, wild annual *Cicer* species were screened and selected for resistance to heat and drought by Canci and Toker [55]. Out of 68 wild *Cicer* species, eight wild species were found as heat and drought resistant sources [55], and the following genotypes of cultivated chickpea including ICC 4958 [56], FLIP 87-59C [57], and ICCV 96029 [6] were confirmed for resistance to heat (up to 41.8 °C) and drought stresses. Four accessions of *C. reticulatum* (AWC 605, AWC 616, AWC 620, and AWC 625), and one accession of *C. pinnatifidum* (AWC 500) were outlined as better as FLIP 87-59C under field conditions [55].

In a pot experiment, perennial wild *Cicer* species were generally more resistant to drought stress than annual wild and cultivated chickpeas. *C. anatolicum*, *C. microphyllum*, and *C. songaricum* showed similar resistance values to drought stress, followed by *C. oxydon* and *C. montbretti* [13]. Although perennial wild chickpea have been shown to be resistant to drought stress, there have been no reports on hybridization between perennial wild chickpeas and cultivated chickpeas so far. As for annual wild *Cicer* species, *C. reticulatum* has already been crossed with cultivated chickpeas [58, 59, 60, 61]. Further studies need to be carried out regarding the crossing between perennial wild species and cultivated chickpea. Therefore, the role of wild species as genetic resources to be crossed with cultivated species must continue to be studied in long-term breeding programs to produce chickpea cultivars

that are tolerant to high- temperature and drought stresses. The limited number of accessions of *C. reticulatum* in the world was increased from 18 accessions to 513 accessions with a

collection mission between 2013 and 2015 in Turkey but new accessions have

TABLE III. THE QTLs OR GENES IDENTIFIED FOR TOLERANCE TO DROUGHT STRESS IN CHICKPEA

Traits	QTL Interval	Linkage Group	Phenotypic Variation (%)
<i>Root</i>			
Root surface area	TA106–H1116	CaLG06	10.26
Root length density	NCPGR127–NCPGR21 ^A	CaLG04	10.90
R : T ration	TAA170–NCPGR21 ^A	CaLG04	16.67
<i>Morphological</i>			
Plant height	TA34–NCPGR49	CaLG03	10.00
	NCPGR127–NCPGR21 ^A	CaLG04	30.20
	CaM1760–CaM399	CaLG06	13.12
	NCPGR164–CaM2187	CaLG06	14.73
Shoot dry weight	TAA170–NCPGR21 ^A	CaLG04	17.59
<i>Phenological</i>			
Days to 50% flowering	NCPGR164–CaM1918	CaLG08	26.87
	NCPGR127–TAA170 ^A	CaLG04	24.49
Days to maturity	NCPGR127–TAA170 ^A	CaLG04	19.71
	NCPGR164–CaM1918	CaLG08	18.83
	NCPGR164–CaM1918	CaLG06	12.13
<i>Yield related</i>			
Harvest index	NCPGR184–ICCM0009b	CaLG01	10.67
	cpPb-679915–CaM0393	CaLG01	14.36
	TAA170–NCPGR21 ^B	CaLG04	11.69
Yield	TAA170–NCPGR21 ^A	CaLG04	15.72
	NCPGR136–CaM0046	CaLG01	13.98
Pods per plant	NCPGR127–NCPGR21	CaLG04	23.18
Seeds per pod	TAA170–NCPGR21 ^A	CaLG04	42.07
Weight of 100 seeds	NCPGR127–NCPGR21 ^A	CaLG04	58.20
	NCPGR184–ICCM0009b	CaLG01	10.31
Biomass	NCPGR164–CaM1918	CaLG08	10.95
	NCPGR127–NCPGR21 ^B	CaLG04	21.32
<i>Drought indices</i>			
Drought tolerance index	cpPb-679915–CaM0046	CaLG04	11.23

TABLE IV. THE QTLs OR GENES IDENTIFIED FOR TOLERANCE TO HEAT STRESS IN CHICKPEA

Traits	Marker Interval	Linkage Group	Phenotypic Variation (%)
Grain yield			13.30
Number of seeds per plot	Ca5_44667768-	CaLG05	16.56
Percentage pod setting (%)	Ca5_46955940		10.00
Number of filled pods per plot			12.03
Grain yield			6.96
Number of seeds per plot	Ca6_7846335-	CaLG06	3.92
Percentage pod setting (%)	Ca6_14353624		5.92
Number of filled pods per plot			9.04

not studied for resistance to heat and drought stresses despite of great potential [55].

CONCLUSION

Wild Cicer species are considered to be superior to drought and heat stresses. Perennial wild species including *C. anatolicum*, *C. microphyllum*, *C. montbretti*, *C. oxydon* and *C. songaricum* were found to be tolerant to drought

stress. *C. pinnatifidum* and *C. reticulatum* have been shown to be tolerant to heat and drought stress. Although some wild species are proven to be resistant to heat and drought stress, only *C. reticulatum* has already been crossed with cultivated chickpea, and it is thought that *C. anatolicum* and wild

perennial wild chickpeas is also suggested, but requires a long-term to optimize this potential.

ACKNOWLEDGMENTS

We thank Scientific Research Project Coordination Unit of Akdeniz University (FDK-2019-4122) and TUBITAK (117O045) since CT participated in the conference via support of these projects.

REFERENCES

- [1] Romdhane, B.S., Trabelsi, M., Aouani, M.E., de Lajudie, P., Mhamdi, R. (2009). The diversity of rhizobia nodulating chickpea (*Cicer arietinum*) under water deficiency as a source of more efficient inoculants. *Soil Biol. Biochem.* 41,2568–2572.
- [2] Singh, U., Singh, B. (1992). Tropical grain legumes as important human foods. *Econ. Bot.* 46,310–321.
- [3] Hanbury, C., White, C., Mullan, B., Siddique, K.H. (2000). A review of the potential of *Lathyrus sativus* L. and *L. cicera* L. grain for use as animal feed. *Anim. Feed Sci. Technol.* 87,1–27.
- [4] FAO. (2017). The Food and Agriculture Organization of the United Nations. Retrieved from <http://www.fao.org/faostat/en/#data/QC/visualize>.
- [5] Singh, K.B., Omar, M., Saxena, M.C., Johansen, C. (1997). Screening for drought resistance in spring chickpea in the Mediterranean region. *J Agron Crop Sci.* 178, 227–235.
- [6] Kumar, J., and Abbo, S. (2001). Genetics of flowering time in chickpea and its bearing on productivity in semiarid environments. *Adv Agron.* 72, 107–138.
- [7] Ryan, J.G. (1997). A global perspective on pigeonpea and chickpea sustainable production systems: present status and future potential. In: Asthana AN, Ali M (eds) Recent advantages in pulses research. Indian Society of Pulses Research and Development, IIPR, Kanpur, pp 1–31.
- [8] Siddique, K.H.M., Brinsmead, R.B., Knight, R., Knights, E.J., Paull, J.G., Rose, I.A. (2000). Adaptation of chickpea (*Cicer arietinum* L.) and faba bean (*Vicia faba* L.) to Australia. In: Knight R (ed) Linking research and marketing opportunities for pulses in the 21st Century. *Kluwer Academic Publishers*. Dordrecht. pp 289–303.
- [9] Leport, L., Turner, N.C., French, R.J., Barr, M.D., Duda, R., Davies, S.L., Tennant, D., Siddique, K.H.M. (1999). Physiological responses of chickpea genotypes to terminal drought in a Mediterranean-type environment. *Eur J Agron.* 11, 279–291.
- [10] Kalra, N., Chakraborty, D., Sharma, A., Rai, H.K., Jolly, M., Chander, S., Kumar, P.R., Bhadraraj, S., Barman, D., Mittal, R.B., et al. (2008). Effect of temperature on yield of some winter crops in northwest India. *Curr. Sci.* 94, 82–88.
- [11] Toker, C., and Cagirgan, M.I. (1998). Assessment of response to drought stress of chickpea (*Cicer arietinum* L.) lines under rainfed conditions. *Turkish J. Agric. For.* 22, 615–621.
- [12] Devashirvatam, V., Tan, D.K.Y. (2018). Impact of High Temperature and Drought Stresses on Chickpea Production. *Agronomy.* 8 (145), 1-9.
- [13] Toker, Cengiz., Canci, H., Yildirim, T. (2007). Evaluation of perennial wild *Cicer* species for drought resistance. *Genet Resour Crop Evol.* 54, 1781-1786.
- [14] Toker, C., Uzun, B., Ceylan, F.O., Ikten, C. (2014). Chickpea. In: Alien Gene Transfer in Crop Plants, Pratap, A and Kumar, J. Eds., Volume 2. Springer. Dordrecht. 121-151.
- [15] Raza, Ali., Razzaq, Ali., Mehmood, S.S., Zou, Xiling., Zhang, Xuekun., Lv, Yan., Xu, Jinsong. (2019). Impact of Climate Change On Crops Adaption and Strategies to Tackle Its Outcome : A Review. *Plants.* 8 (34), 1-29
- [16] Trenberth, K.E., Christian, J.G. (1996). Physical Processes Involved in the 1988 Drought and 1993 Floods in North America. *Journal of Climate.* 9, 1288-1298.
- [17] Mo, K.C., Paegle, J.N., Higgins, R.W. (1997). Atmospheric Processes Associated with Summer Floods and Droughts in the Central United States. *Journal of Climate.* 10, 3028-3046.
- [18] Wang, K., Dickinson, R.E., Liang, S. (2012). Global atmospheric evaporative demand over land from 1973 to 2008. *J. Clim.* 25, 8353-8361.
- [19] Dai, Aiguo., Kevin, E.T., Thomas, R.K. (1998). Global Variations in Droughts and Wet Spells: 1900-1995. *Geophysical Research Letters.* 25 (17), 3367-3370
- [20] Hatfield, J.L., Prueger, J.H. (2015). Temperature extremes: Effect on plant growth and development. *Weather Clim. Extrem.* 10, 4–10.
- [21] Winkel, T., Renno, J.F., Payne, W. (1997). Effect of the timing of water deficit on growth, phenology and yield of pearl millet (*Pennisetum glaucum* (L.) R. Br.) grown in Sahelian conditions. *J. Exp. Bot.* 48, 1001–1009.
- [22] Barlow, K., Christy, B., O’leary, G., Riffkin, P., Nuttall, J. (2015). Simulating the impact of extreme heat and frost events on wheat crop production: A review. *Field Crops Res.* 171, 109-119.
- [23] Salehi-Lisar, S.Y., Bakhshayeshan-Agdam, H. (2016). Drought stress in plants: Causes, consequences, and tolerance. *Drought Stress Tolerance in Plants*. Springer. 1, 1-16.
- [24] Davies, W. J., and Zhang, J. (1997). Root signals and the regulation of growth and development of plants in drying soil. *Annual Review of Plant Physiology and Plant Molecular Biology.* 42, 55-76.
- [25] Berry, J., and Bjorkman, O. (1980). Photosynthetic response and adaptation to temperature in higher plants. *Annual Review of Plant Physiology.* 31, 491-543.
- [26]
- [27] Sinha, S.K. (1977). Food Legumes: Distribution, Adaptability, and Biology of Yield. FAP Plant Production and Protection Paper No.3. *Food and Agriculture Organization of the United Nations*. Rome, Italy. 124 p.
- [28] Devasirvatham, V., Gaur, P.M., Mallikarjuna, N., Raju, T.N., Trethoean, R.M., Tan, D.K.Y. (2013). Reproductive biology of chickpea to heat stress in the field is associated with the performance in controlled environments. *Field Crops Res.* 142, 9–19.
- [29] Krishnamurthy, L., Gaur, P.M., Basu, P.S., Chaturvedi, S.K., Tripathi, S., Vadez, V., Rathore, A., Varshney, R.K., Gowda, C.L.L. (2011). Large genetic variation for heat tolerance in the reference collection of chickpea (*Cicer arietinum* L.) germplasm. *Plant Genet. Resour.* 9, 59–69.
- [30] Kaushal, N., Awasthi, R., Gupta, K., Gaur, P.M., Siddique, K.H.M., Nayyar, H. (2013). Heat stress induced reproductive failures in chickpea (*Cicer arietinum*) are associated with impaired sucrose metabolism in leaves and anthers. *Funct. Plant Biol.* 40.
- [31] Maqbool, M.A., Aslam, Muhammad., Ali, Hina. (2017). Breeding for improved drought tolerance in Chickpea (*Cicer arietinum* L.). *Plant Breeding.* 136, 300-318.
- [32] Mafakheri, A., Siosemardeh, A., Bahramnejad, B., Struik, P.C., Sohrabi, Y. (2010). Effect of drought stress on yield, proline and chlorophyll contents in three chickpea cultivars. *Australian J. Crop Sci.* 4, 580-585.
- [33] Ma’ruf, Amar., Putra, E.T.S., Waluyo, Sriyanto. (2016). Effect of Pyraclostrobin On Physiological Activity, Productivity and Quality of Shoot of Assamica Tea (*Camellia sinensis* var. Assamica (Mast.) Kitamura) During The Dry Season. Master Thesis. Gadjah Mada University
- [34] Bidwell, R.G.S. (1974). *Plant Physiology.* 2nd edition. *Macmillan Publishing Co.* New York. pp: 193–201.
- [35] Pouresmael, M., Khavari-Nejad, R. A., Mozafari, J., Najafi, F., Mo-radi, F. (2013). Efficiency of screening criteria for drought tolerance in chickpea. *Arch. Agronomy Soil Sci.* 59, 1675-1693.
- [36] Randhawa, Navkiran., Kaur, Jagmeet., Singh, Sarvjeet., Singh, Inderjit. (2014). Growth and yield in chickpea (*Cicer*

- arietinum* L.) genotypes in response to water stress. *African Journal of Agricultural Research*. 9 (11), 982-992.
- [37] Lakshmi, K. S. (2005). An Analysis of Gametophytic and Sporophytic Tolerance to Moisture Stress in Chickpea (*Cicer arietinum* L.). Master of Science (Agriculture). University of Agricultural Sciences, Dharwad. Department of Genetics and Plant Breeding College of Agriculture, Dharwad, University of Agricultural Sciences, Dharwad-580005.
- [38] Hussain, N., Aslam, M., Ghaffar, A., Irshad, M., Naeem-ud-Din. (2015). Chickpea genotypes evaluation for morpho-yield traits under water stress conditions. *J. Anim. Plant Sci.* 25, 206-211.
- [39] Gunes, A., N. Cicek., A. Inal., M. Alpaslan., F. Eraslan., E. Guneri., T. Guzelordu. (2006). Genotypic response of chickpea (*Cicer arietinum* L.) cultivars to drought stress implemented at pre and post-anthesis stages and its relations with nutrient uptake and efficiency. *Plant Soil Environ.* 52, 368-376.
- [40] Ma'ruf, Amar., Putra, E.T.S., Waluyo, Sriyanto. (2016). Effect of Pyraclostrobin Concentration On Shoot Quality of Assamica Tea (*Camellia sinensis* var. Assamica (Mast.) Kitamura) Clones During The Dry Season. *Agricultura*. 1-2, 7-15.
- [41] Labidi, N., Mahmoudi, H., Dorsaf, M., Slama, I., Abdelly, C. (2009). Assessment of intervarietal differences in drought tolerance in chickpea using both nodule and plant traits as indicators. *JPBCS*. 1, 80-86.
- [42] Ahmed, H. (2011). Evaluation of Chickpea (*Cicer arietinum* L.) Genotypes for Genetic Parameters and Drought Tolerance. Master of Science in Biology (Applied Genetics). Graduate Studies of Addis Ababa University.
- [43] Nayyar, H., Singh, S., Kaur, S., Kumar, S., Upadhyaya, H. D. (2006). Differential sensitivity of macrocarpa and microcarpa types of chickpea (*Cicer arietinum* L.) to water stress: association of contrasting stress response with oxidative injury. *J. Integr. Plant Biol.* 48, 1318-1329.
- [44] Canci, H., Toker, C. (2009a). Evaluation of annual wild *Cicer* species for drought and heat resistance under field conditions. *Genet Resour Crop Evol.* 56, 1-6.
- [45] Mansourifar, C., Shaban, M., Ghobadi, M., Ajirlu, A.R. (2011). Effect of drought stress and N fertilizer on yield, yield components and grain storage proteins in chickpea (*Cicer arietinum* L.) cultivars. *Afr. J. Plant Sci.* 5, 634-642.
- [46] Thudi, M., Gaur, P.M., Krishnamurthy, L., Mir, R.R., Kudapa, H., Fikre, A., Kimurto, P., Tripathi, S., Soren, K.R., Mulwa, R., Bharadwaj, C., Datta, S., Chaturvedi, S.K., Varshney, R.K. (2014). Genomics-assisted breeding for drought tolerance in chickpea. *Functional Plant Biology*. 41 (11), 1178-1190
- [47] Van der Maesen, L.J., Pundir, R.P.S. (1984). Availability and use of wild *Cicer* germplasm. FAO/IBPGR. *Plant Genetic Resources Newsletter*. 57, 19-24.
- [48] Singh, K.B., Weigand, S. (1994). Identification of resistant sources in *Cicer* species to *Liriomyza cicerina*. *Genet Resour Crop Evol.* 41, 75-79.
- [49] Robertson, L.D., Singh, K.B., Ocampo, B. (eds). (1995). A catalog of annual *Cicer* species. ICARDA, Aleppo, Syria
- [50] Singh, K.B., Ocampo, B., Robertson, L.D. (1998). Diversity for abiotic and biotic stress resistance in the wild annual *Cicer* species. *Genet Resour Crop Evol.* 45, 9-17.
- [51] Rao, N.K., Reddy, L.J., Bramel, P.J. (2003). Potential of wild species for genetic enhancement of some semi-arid food crops. *Genet Resour Crop Evol.* 50, 707-721.
- [52] Toker, C. (2005). Preliminary screening and selection for cold tolerance in annual wild *Cicer* species. *Genet Resour Crop Evol.* 52, 1-5.
- [53] Sharma, H.C., Bhagwat, M.P., Pampapathy, G., Sharma, J.P., Ridsdill-Smith, T.J. (2006). Perennial wild relatives of chickpea as potential sources of resistance to *Helicoverpa armigera*. *Genet Resour Crop Evol.* 53, 131-138.
- [54] Canci, H., Toker, C. (2009). Evaluation of Yield Criteria for Drought and Heat Resistance in Chickpea (*Cicer arietinum* L.). *Journal of Agronomy and Crop Science* 195 (1), 47-54.
- [55] Talip, M., Adak, A., Kahraman, A., Berger, J., Sari, D., Sari, H., Penmetsa, R.V., von Wettberg, E.J, Cook, D.R., Toker, C. (2018). Agro-Morphological traits of *Cicer reticulatum* Ladizinsky in comparison to *C. echinospermum* P.H. Davis in terms of potential to improve cultivated chickpea (*Cicer arietinum* L.). *Genetic Resources and Crop Evolution*. 65 (3), 951-962.
- [56] Saxena, N. P., Krishnamurthy, L., Johansen, C. (1993). Registration of drought-resistant chickpea germplasm. *Crop Sci.* 33, 1424.
- [57] Singh, P., Virmani, S.M. (1996). Modeling growth and yield of chickpea (*Cicer arietinum* L.). *Field Crop Res.* 46, 41-59.
- [58] Muehlbauer, F.J., Kaiser, W.J., Simon, C.J. (1994). Potential for wild species in cool season food legume breeding. *Euphytica*. 73, 109-114.
- [59] Koseoglu, K., Adak, A., Sari, D., Sari, H., Ceylan, F.O., Toker, C. (2017). Transgressive segregation for yield criteria in reciprocal interspecific crosses between *C. arietinum* L. and *C. reticulatum* Ladiz. *Euphytica*. 213, 116.
- [60] Adak, A., Sari, D., Sari, H., Toker, C. (2017). Gene effects of *Cicer reticulatum* on qualitative and quantitative traits in the cultivated chickpea. *Plant Breeding*. 136, 939-947.
- [61] Ceylan, F.O., Adak, Alper., Sari, Duygu., Sari, Hatice., Toker, Cengiz. (2019). Unveiling of suppressed genes in interspecific and backcross populations derived from mutants of *Cicer* species. *Crop and Pasture Science*. 70, 254-262.



ICoSI